



SAWEEZ®

Quality Hand-Crafted
German Surgical Instruments

MANUFACTURERS AND EXPORTERS OF SURGICAL INSTRUMENTS



[/saweez.com](https://www.saweez.com)



+92 (052) 45 92 136



+92 (052) 45 92 136

SAWEEZ SURGICAL CORPORATION BASED IN OKLAHOMA, US SINCE 2009 TO PROVIDE HIGH PERFORMANCE IN SURGICAL INSTRUMENTS, ORTHOPEDICS, SCISSORS, EQUINE PRODUCTS AT COMPETITIVE PRICES TOGETHER WITH PROFESSIONAL AND FRIENDLY SERVICE.

SAWEEZ SURGICAL CORPORATION MANUFACTURING UNIT IN PAKISTAN WITH THE NAME OF SAWEEZ SURGICAL CORPORATION ARE PRODUCING THE GOODS AS PER INTERNATIONAL STANDARD SUCH AS ISO 9001 – ISO 13485 – ISO 14001 – CE – CGMP (FDA).

WE HAVE SUCCESSFULLY DEVELOPED A WIDE VARIETY OF INSTRUMENTS SERIES FOR DIFFERENT APPLICATIONS, AISI 410 / 420 / 304 TYPE OF STAINLESS STEEL. THE PRODUCTS OFFERED PASS THROUGH A RIGOROUS QUALITY CONTROL PROCESS MEANING THAT THE PRODUCT MUST HAVE EXCELLENT CONDITION OF POLISH / MATT FINISH, MEASURES, DESIGNS AND BEING MADE WITH THE BEST QUALITY STAINLESS STEEL.

SAWEEZ SURGICAL CORPORATION WILL STRIVE TO ENSURE THAT A CLOSE RELATIONSHIP EXISTS WITH ALL CUSTOMERS. THIS RELATIONSHIP MUST BE MAINTAINED BY THE PROVISION OF UNQUESTIONABLE SERVICE, PRODUCT QUALITY AND THE UNDERSTANDING OF THE IMPORTANCE OF CONTINUED PRODUCT DEVELOPMENT.

IN SHORT, WITH THE STRONG QUALIFIED TEAM, WE CAN DESIGN ANY SPECIAL INSTRUMENTS TO MEET ANY SPECIFIC REQUIREMENTS. SAWEEZ SURGICAL CORPORATION EMPLOYS A HIGHLY FOCUSED GROUP OF PERSONAL WHO COMBINE HIGH ACADEMIC STANDARDS WITH YEARS OF EXPERIENCE TO ENSURE A CONTINUOUS FLOW OF HIGH INNOVATIVE PRODUCTS FOR THEIR CUSTOMERS.

THANKS TO THE CONTINUOUS SUPPORT FROM OUR CUSTOMERS, SAWEEZ SURGICAL CORPORATION HAS GAINED IT'S REPUTATION AS A WORLD-CLASS SUPPLIER OF INSTRUMENTATION.

SAWEEZ SURGICAL CORPORATION



TABLE OF CONTENTS

11

GENERAL INSTRUMENTS

1-151

SCALPEL HANDLES	TISSUE FORCEPS	TOWEL FORCEPS	NOSTICS
OPERATING SCISSORS	ARTERY FORCEPS	SUPERCUT SCISSORS	ANESTHESIA
DISSECTING SCISSORS	KEDNEY PEDICLE CLAMP	RETRACTOS	TROCARS
DRESSING FORCEPS	CLAMPS, HYSTERECTOMY	ABDOMINAL RETRACTOS	SUTURE



152-154

DIAGNOSTICS INSTRUMENTS

PERCUSSION HAMMERS
SENSIBILITY INSTRUMENTS
STETHOSCOPES

13

15

VACCINATION & PUNCTURE

155-162

TROCARS
SUCTION TUBES



163-184

SUTURE INSTRUMENTS

MICRO-NEEDLE HOLDERS
NEEDLE HOLDERS
REVERDIN NEEDLES
NEEDLE HOLDER TUNGSTEN CARBIDE INSERTS

17

19

PLASTER CAST INSTRUMENTS

185-189

BANDAGE SCISSORS	PLASTER CAST INSTRUMENTS
CLOTHING SCISSORS	
PLASTER SCISSORS	
PLASTER OF PARIS KNIVES, SAWS	



190-193

ORTHOPEDIC INSTRUMENTS

PIN CUTTER & WIRE CUTTERS
PLIERS
PLIERS & CALIPERS

21



TABLE OF CONTENTS

23

BONE SURGERY

194-268

BONE CHISELS & COUGES
HEMOSTATS, MALLET
BONE CURETTES
PERIOSTEAL RASPATORIES

ELEVATORS, BONE LEVERS
MENISCOTOMY KNIVES
BONE HOLDING FORCEPS
BONE CUTTING FORCEPS

FLAT NOSE PLIERS
WIRE CUTTING PLIERS
EXTENSION BOWS



269-271

ASEPSIS INSTRUMENTS

25

NAIL NIPPERS
CUTICLE NIPPERS
CUTICLE SCISSORS
LOADING & STERILISING FORCEPS

27

RHINOLOGY INSTRUMENTS

272-302

NASAL SPECULA
DRESSING TAMPON
NASAL CUTTING FORCEPS
SEPTUM SCISSORS

SPHENOID PUNCHES, ANTRUM PUNCH FORCEPS
SEPTUM & PERIOSTEAL ELEVATORS



303-337

CARDIOVASCULAR INSTRUMENTS

29

BONE & RIB SHEARS
RIB SPREADERS
TISSUE & ORGAN HOLDING FORCEPS
ATRAUMA TISSUE FORCEPS

ATRAUMA BULLDOG FORCEPS
ATRAUMA CARDIOVASCULAR FORCEPS

31

INTESTINES STOMACH RECTUM

338-350

TISSUE & ORGAN HOLDING FORCEPS
INTESTINAL CLAMP FORCEPS
STOMACH CLAMP FORCEPS
RECTAL SPECULA

RETRACTORS
HEAMORRHOIDAL (PILE) FORCEPS



351-358

LIVER, GALL BLADDER, KIDNEY

33

KIDNEY STONE FORCEPS
GALL STONE SCOOPS
PROSTATIC RETRACTORS
BLADDER RETRACTORS

DILATING BOUGIES
METAL CATHETERS



TABLE OF CONTENTS

35

RECTAL & GENTO-URINARY

359-361

SPECULA
RETRACTORS



362

TRACHEOTOMY INSTRUMENTS

TRACHEA DILATORS
TRACHEA TUBES

37

39

GYNECOLOGY INSTRUMENTS

363-393

VAGINAL SPECULA
RETRACTORS, ENDOSPECULA
UTERINE DILATORS
TENACULUM FORCEPS

MYOMA INSTRUMENTS
UTERINE ELEVATING FORCEPS



394-418

NEURO-SURGERY INSTRUMENTS

GALES HOOKS
DURA DISSECTORS
BRAIN SPATULAS
NERVE ROOT RETRACTORS

ELEVATORS, KNIVES, DURA HOOKS
LAMINA SPREADERS

41

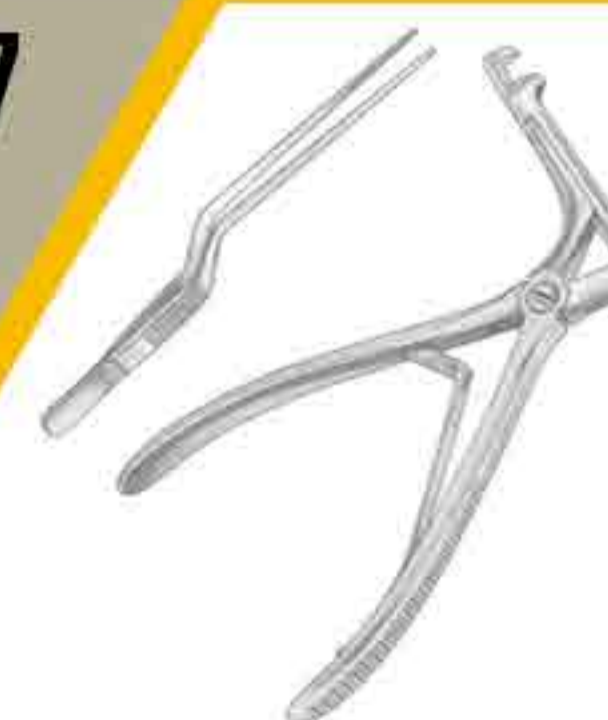
43

OTOLOGY INSTRUMENTS

419-437

MICRO EAR FORCEPS
WIRE CLOSURE FORCEPS
KNIVES, TUNING FORKS
FOREIGN BODY FORCEPS

CURETTES & SPOONS
HOOKLETS



438-449

LIVER, GALL BLADDER, KIDNEY

MOUTH GAGES
TONGUE DEPRESSORS
SOFT TISSUE RETRACTORS
PERIOSTEAL ELEVATORS

AWLS
DISIMPACTION FORCEPS

45



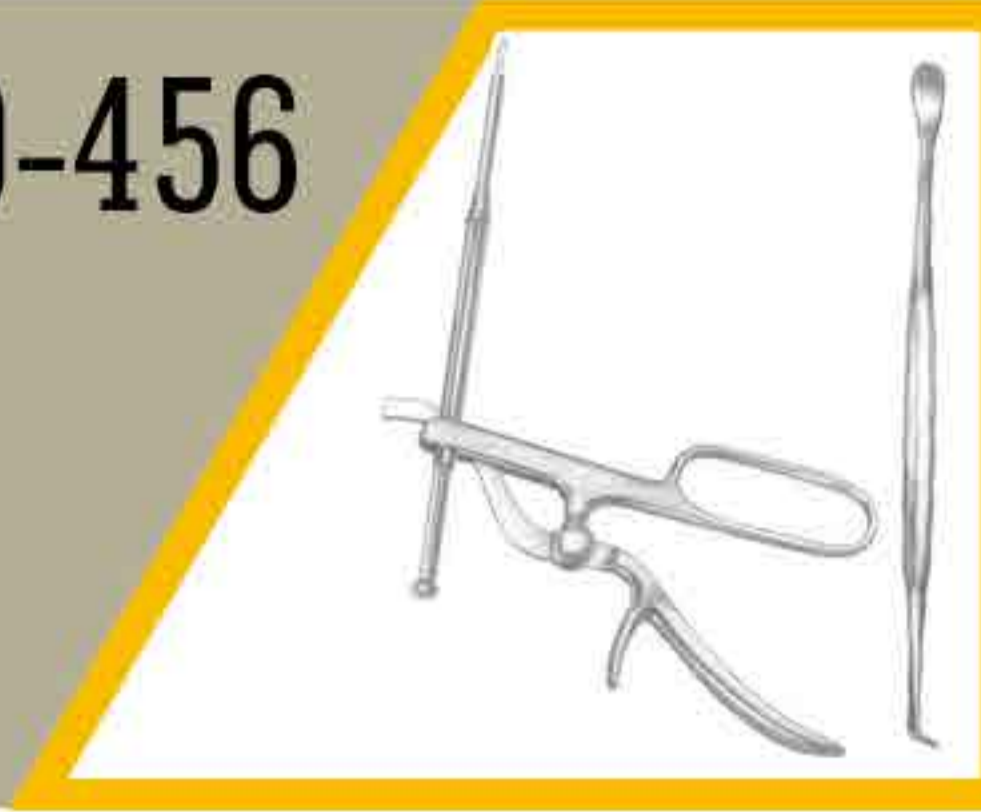
TABLE OF CONTENTS

47

TONSILS & LARYNGO

450-456

TONSILS KNIVES
TONSILS SEIZING FORCEPS
UNIVERSAL HANDLES & INTERCHANGEABLE TUBES
CUTTING & GRASPING FORCEPS TIPS



457-464

ANAESTHESIA INSTRUMENTS

CATHETER FORCEPS
LARYNGOSCOPES
OTOSCOPE & ENT DIAGNOSTIC SET

49

51

ENDOSCOPIC INSTRUMENTS

465-481

GRASPING FORCEPS
DISSECTING FORCEPS & HOOKS
SCISSORS
DETACH SCISSORS SYSTEM

BIOPSY
SPECIALIZATION



482-487

MICRO SURGERY INSTRUMENTS

FORCEPS
NEEDLE HOLDERS
SCISSORS & NEEDLE HOLDERS

53

55

OPHTHALMIC SURGERY

488-514

EYE FORCEPS
FIXATION FORCEPS
UTILITY, SUTURE FORCEPS
JEWELERS FORCEPS

NEEDLE HOLDERS
EYE SCISSORS



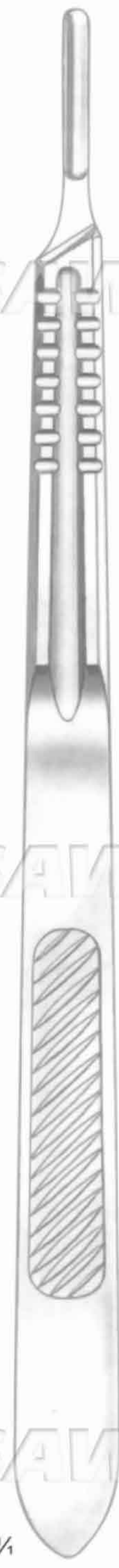
SAWEEZ Double Handle No.4 + No.3 SAWEEZ SAWEEZ SAWEEZ



Standard
SSC-11-11-11
No. 4
Solid



SSC-11-11-12
Solid



SSC-11-11-13
No. 4L
Solid



SSC-11-11-14
No. 4L
Solid Angled

SAWEEZ SAWEEZ SAWEEZ SAWEEZ

SAWEEZ SAWEEZ SAWEEZ SAWEEZ



1/4

1/4

1/4

1/4

1/4

Standard
 SSC-11-11-15
 No. 3
 Solid

SSC-11-11-16
 No. 3
 Solid

SSC-11-11-17
 No. 3
 Solid

SSC-11-11-18
 No. 3L
 Solid Straight

SSC-11-11-19
 No. 3L
 Solid Angled



- SSC-11-11-20 11.5 cm / 4½"
- SSC-11-11-21 13.0 cm / 5"
- SSC-11-11-22 14.0 cm / 5½"
- SSC-11-11-23 16.0 cm / 6¼"
- SSC-11-11-24 18.0 cm / 7"
- SSC-11-11-25 20.0 cm / 8"
- SSC-11-11-26 25.0 cm / 10"

- SSC-11-11-27 11.5 cm / 4½"
- SSC-11-11-28 13.0 cm / 5"
- SSC-11-11-29 14.0 cm / 5½"
- SSC-11-11-30 16.0 cm / 6¼"
- SSC-11-11-31 18.0 cm / 7"
- SSC-11-11-32 20.0 cm / 8"

- SSC-11-11-33 14.0 cm / 5½"
- SSC-11-11-34 16.0 cm / 6¼"
- 2 mm ø

2 mm ø

1 mm ø



- SSC-11-11-35 14.0 cm / 5½"
- SSC-11-11-36 16.0 cm / 6¼"
- 2 mm ø

- SSC-11-11-37 13.0 cm / 5"
- SSC-11-11-38 14.0 cm / 5½"
- SSC-11-11-39 16.0 cm / 6¼"
- SSC-11-11-40 18.0 cm / 7"
- SSC-11-11-41 20.0 cm / 8"
- SSC-11-11-42 25.0 cm / 10"
- 2 mm ø

- Fish**
- SSC-11-11-43 14.0 cm / 5½"
- SSC-11-11-44 18.0 cm / 7"
- 2 mm ø



SAWEEZ SAWEEZ SAWEEZ SAWEEZ



Stacker	SSC-11-11-46	14.0 cm / 5½"	SSC-11-11-49	11.5 cm / 4½"	SSC-11-11-55	13.0 cm / 5"	Doyen	Nelaton
SSC-11-11-45	SSC-11-11-47	16.0 cm / 6¼"	SSC-11-11-50	13.0 cm / 5"	SSC-11-11-56	14.0 cm / 5½"	SSC-11-11-59	SSC-11-11-60
10.0 cm / 4¼"	SSC-11-11-48	20.0 cm / 8"	SSC-11-11-51	14.0 cm / 5½"	SSC-11-11-57	16.0 cm / 6¼"	14.0 cm / 5½"	16.0 cm / 6¼"
1 mm ø			SSC-11-11-52	16.0 cm / 6¼"	SSC-11-11-58	18.0 cm / 7"		
			SSC-11-11-53	18.0 cm / 7"				
			SSC-11-11-54	20.0 cm / 8"				



SAWEEZ SAWEEZ SAWEEZ SAWEEZ

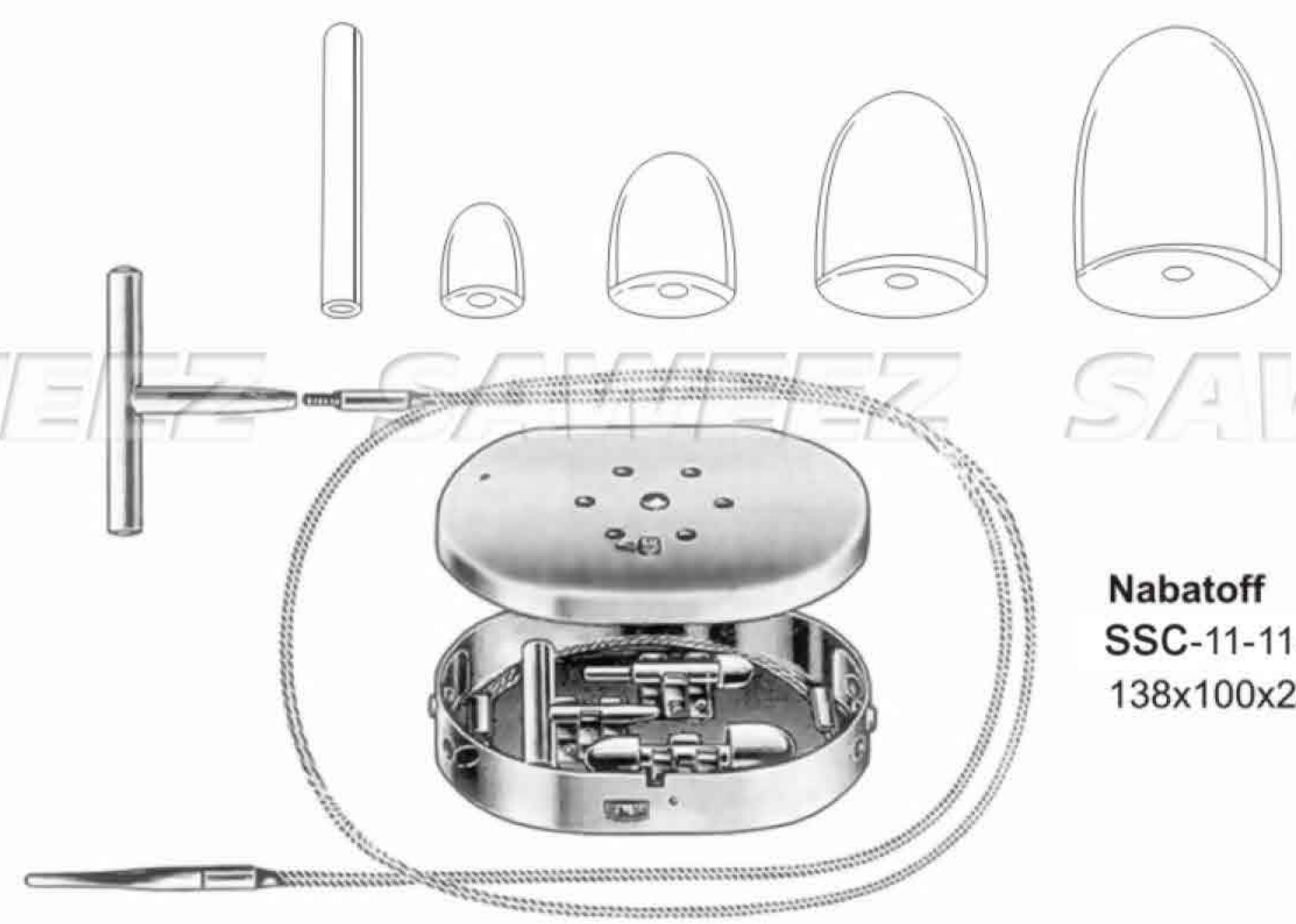
Fluhrer
SSC-11-11-61
40.0 cm / 16"
of tin

Babcock
SSC-11-11-62
40.0 cm / 16"

SSC-11-11-63
complete with 3 cones

SSC-11-11-64
Probe, malleable, only

SSC-11-11-65
Set of cones



Nabatoff
SSC-11-11-66
 138x100x25 mm



Spare Parts



SSC-11-11-67
 Ø 3 mm



SSC-11-11-68
 Ø 6 mm



SSC-11-11-69
 Ø 9 mm



SSC-11-11-70
 Ø 12 mm



SSC-11-11-71
 Ø 15 mm

- Olive, Ø 3 mm
- Olive, Ø 6 mm
- Olive, Ø 9 mm
- Olive, Ø 12 mm
- Olive, Ø 15 mm
- flexibles

- Olive, Ø 3 mm
- Olive, Ø 6 mm
- Olive, Ø 9 mm
- Olive, Ø 12 mm
- Olive, Ø 15 mm
- Handle only
- Cable, flexible, stainless
- Metal case

- Olive, Ø 3 mm
- Olive, Ø 6 mm
- Olive, Ø 9 mm
- Olive, Ø 12 mm
- Olive, Ø 15 mm
- for traction flexibles inoxidable



SAWEEZ SAWEEZ SAWEEZ SAWEEZ



Fein
SSC-11-11-72
28.0 cm / 11"



SSC-11-11-73
45.0 cm / 17¾"



SSC-11-11-74
40.0 cm / 15¾"



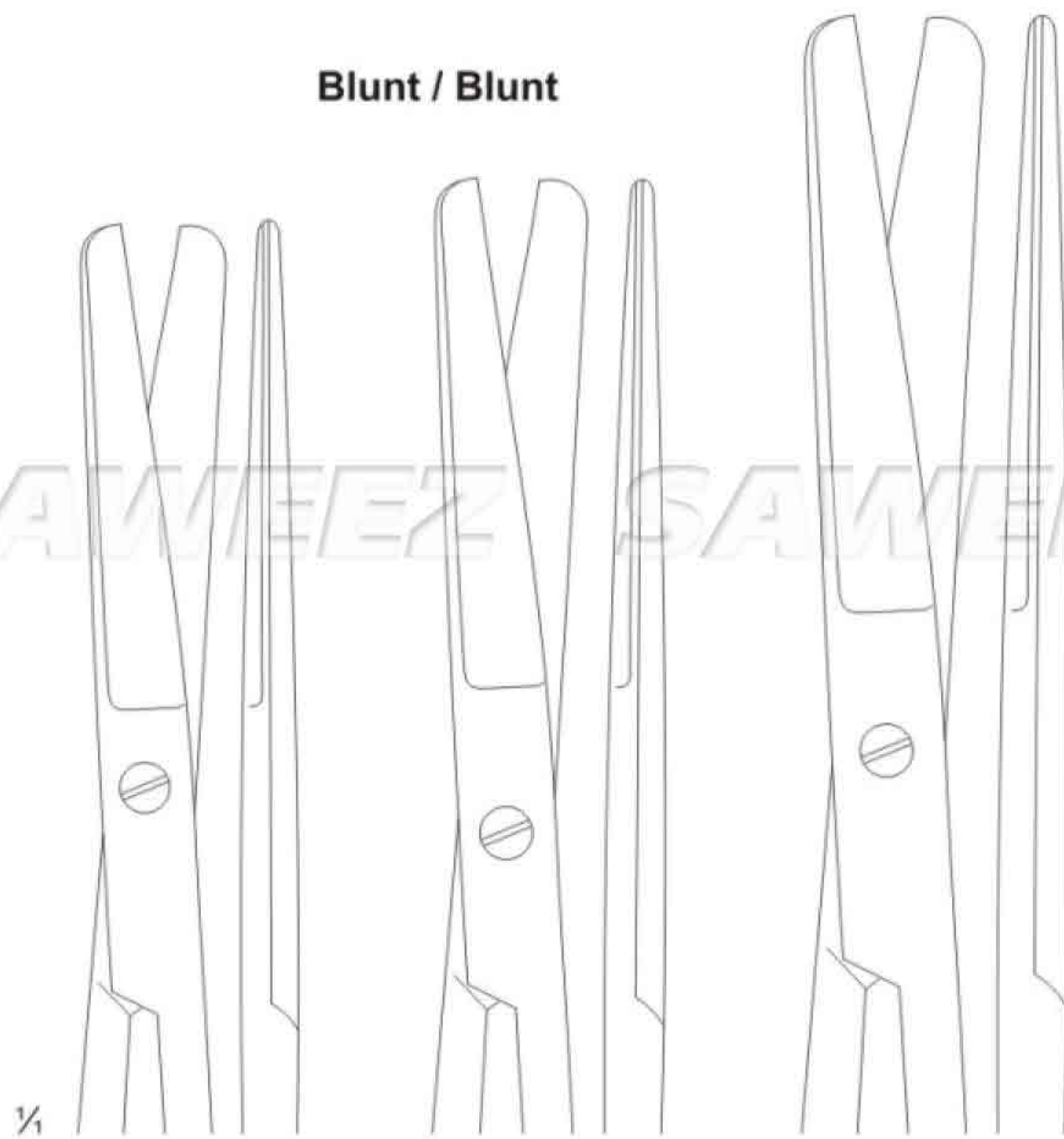
Playfair
SSC-11-11-75
31.0 cm / 12¼"

SAWEEZ SAWEEZ SAWEEZ SAWEEZ



Blunt / Blunt

SAWEEZ SAWEEZ SAWEEZ SAWEEZ



1/4

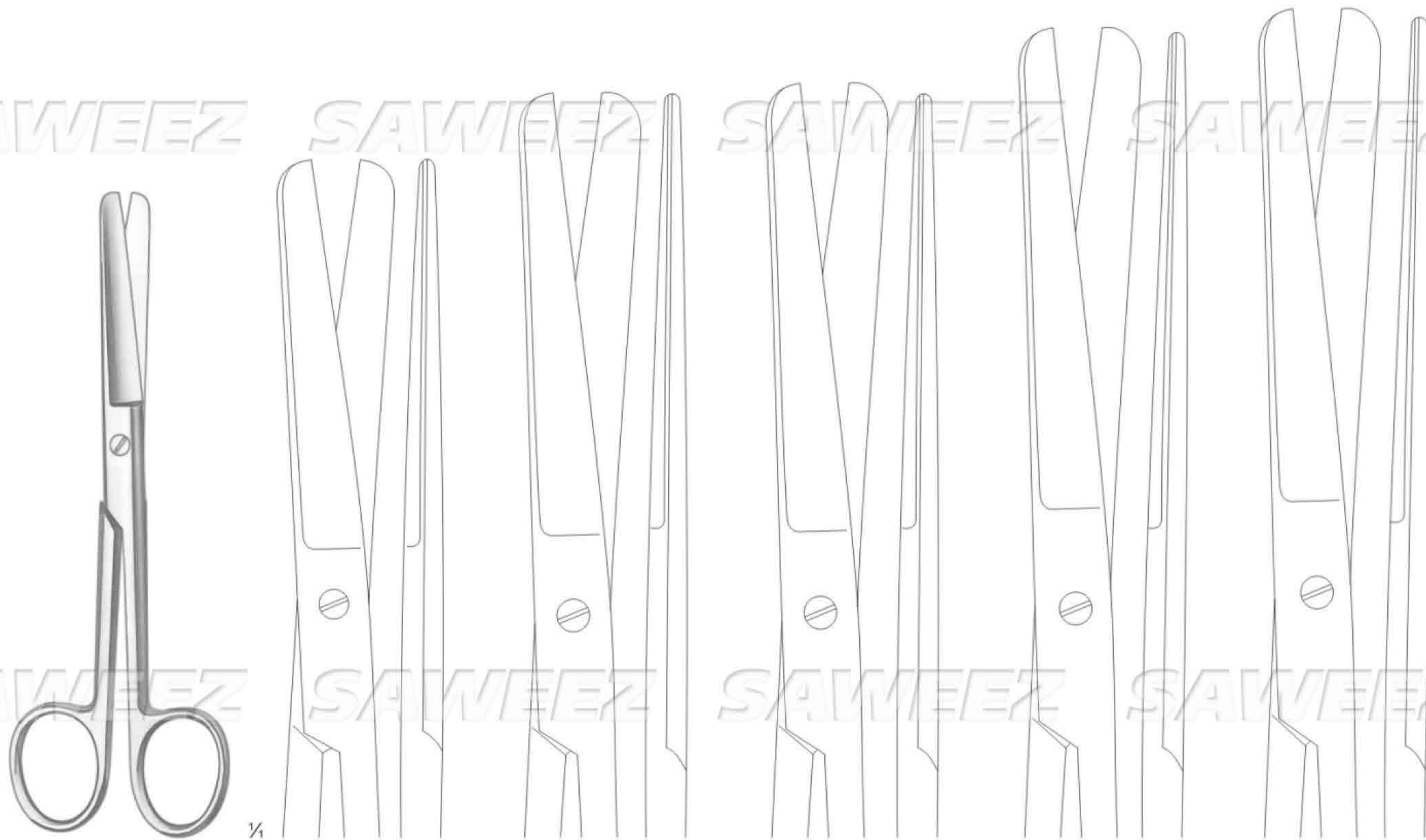
SSC-11-11-76
10.5 cm / 4 1/4"

SSC-11-11-77
11.5 cm / 4 1/2"

SSC-11-11-78
13.0 cm / 5"

SAWEEZ SAWEEZ SAWEEZ SAWEEZ

SAWEEZ SAWEEZ SAWEEZ SAWEEZ



1/4

Standard

SSC-11-11-79
14.0 cm / 5 1/2"

SSC-11-11-80
15.5 cm / 6"

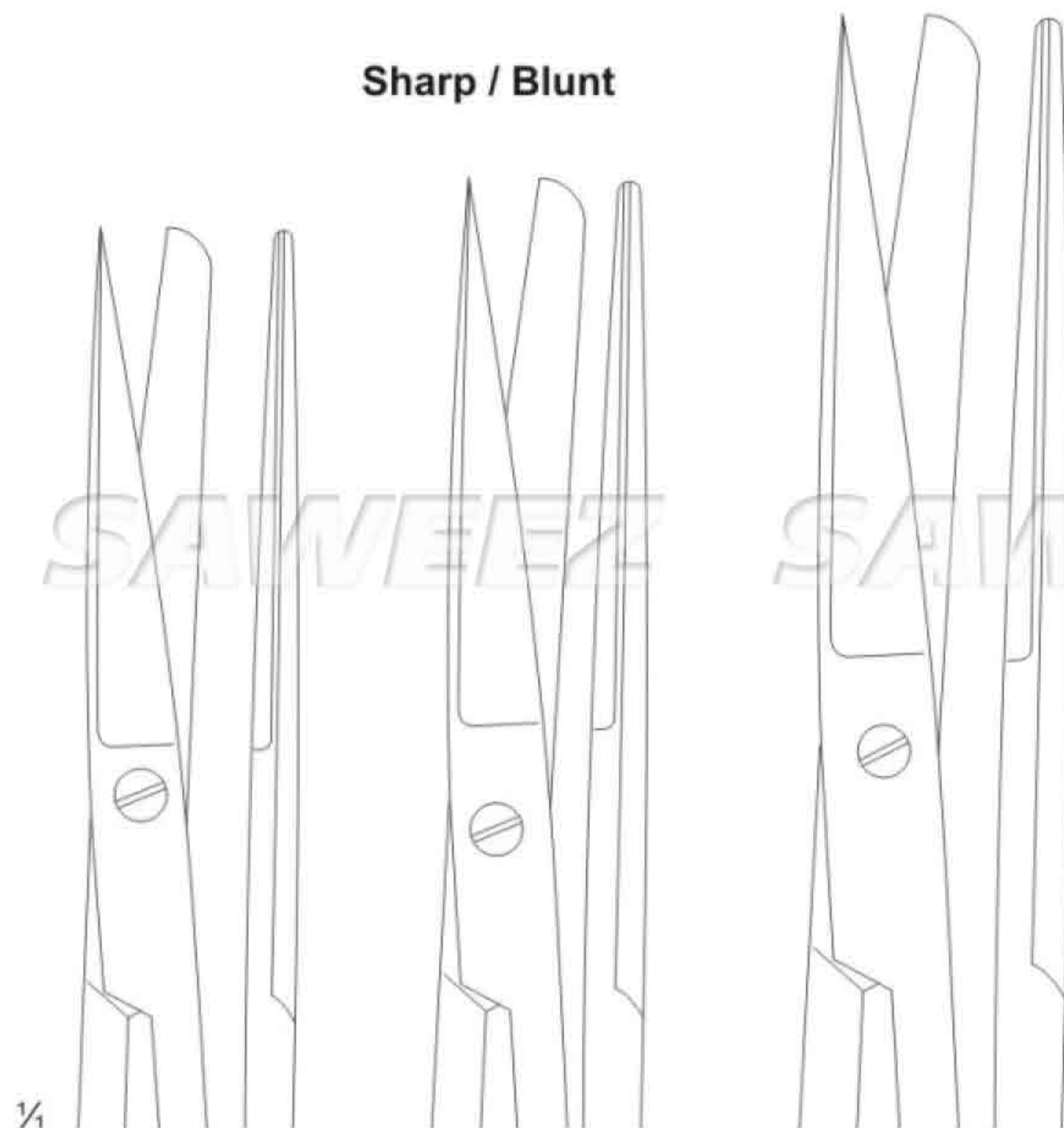
SSC-11-11-81
16.5 cm / 6 1/2"

SSC-11-11-82
18.5 cm / 7 1/4"

SSC-11-11-83
20.0 cm / 8"



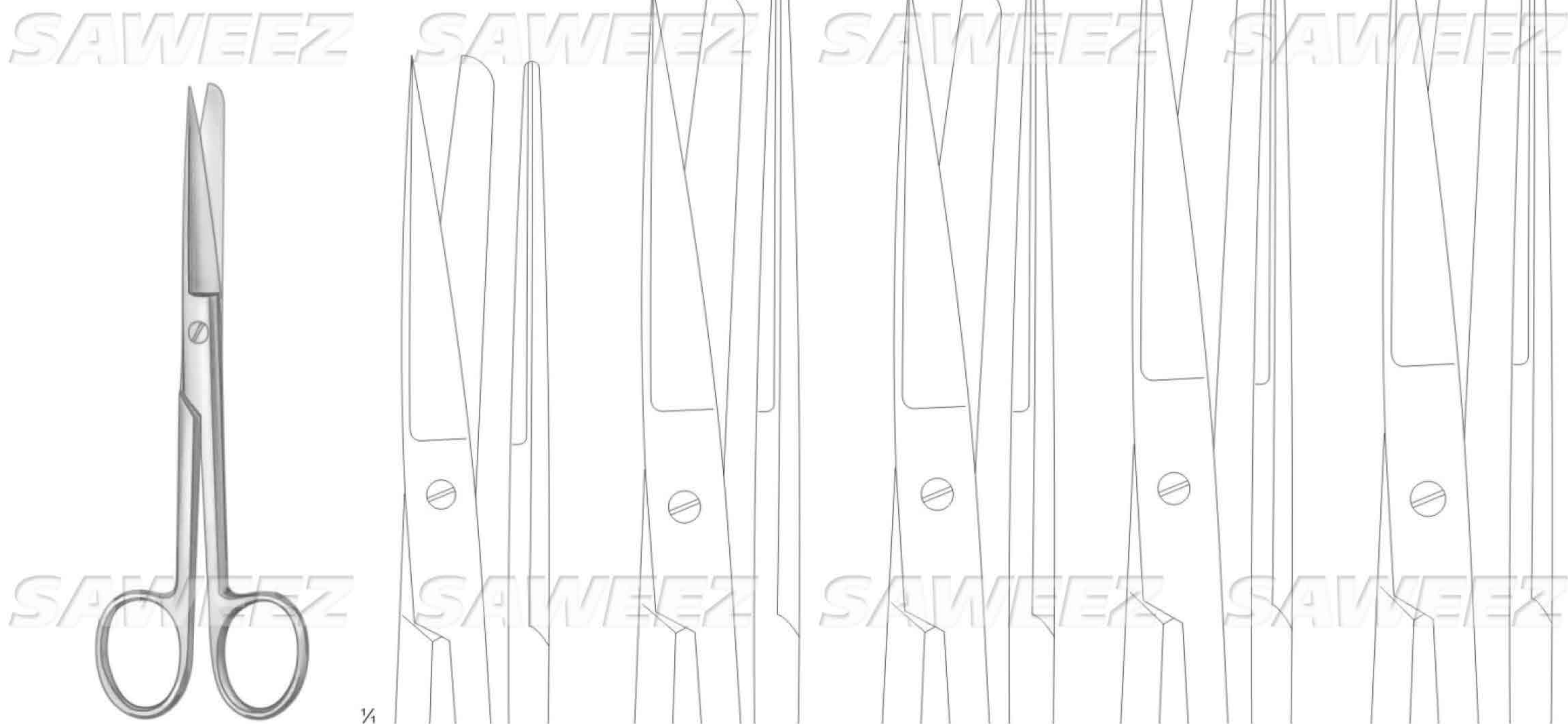
Sharp / Blunt



SSC-11-11-84
10.5 cm / 4 1/4"

SSC-11-11-85
11.5 cm / 4 1/2"

SSC-11-11-86
13.0 cm / 5"



Standard

SSC-11-11-87
14.0 cm / 5 1/2"

SSC-11-11-88
15.5 cm / 6"

SSC-11-11-89
16.5 cm / 6 1/2"

SSC-11-11-90
18.5 cm / 7 1/4"

SSC-11-11-91
20.0 cm / 8"

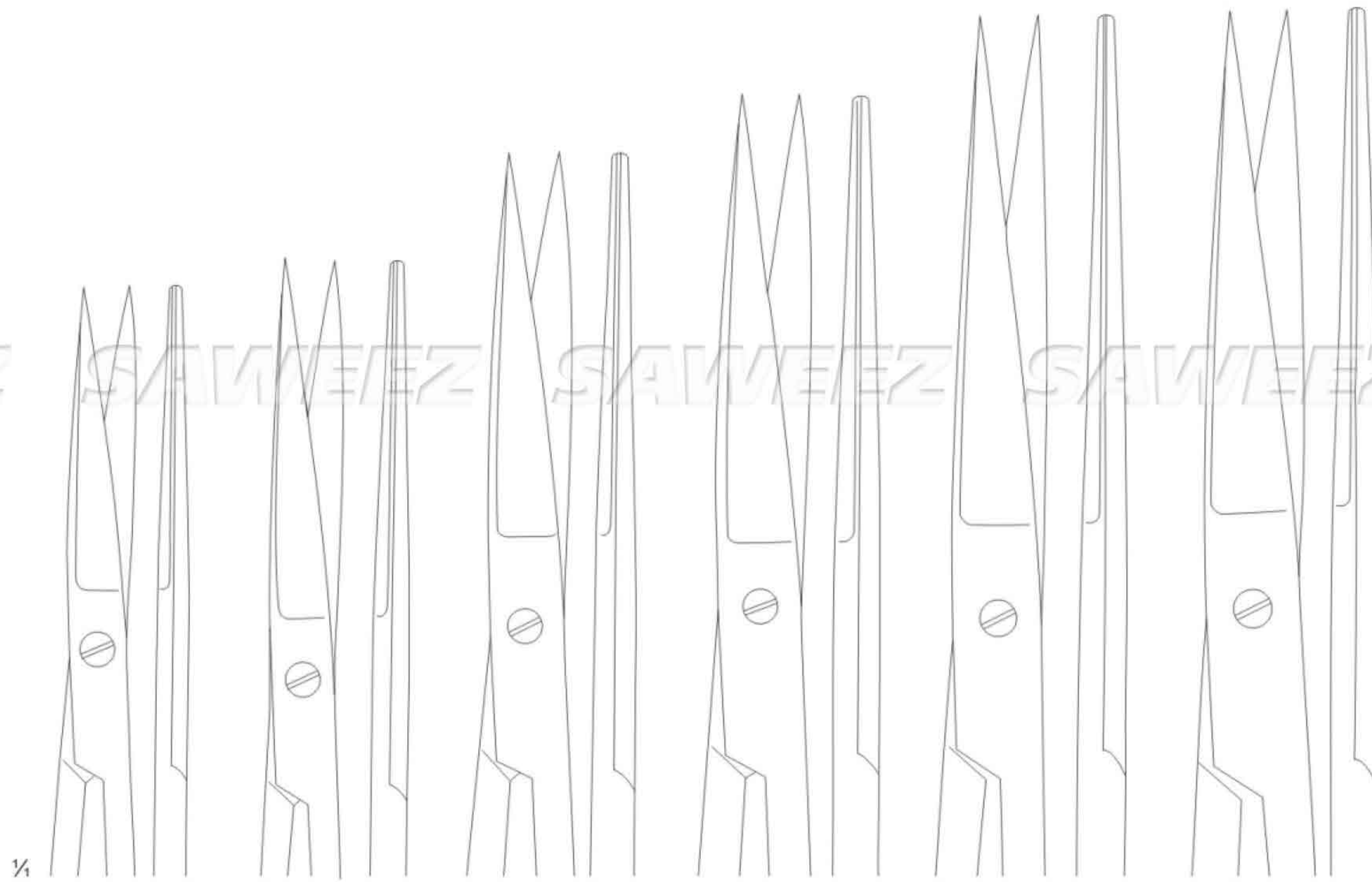


SAWEEZ SAWEEZ SAWEEZ SAWEEZ

Sharp / Sharp



Standard



1/4

SSC-11-11-92
10.5 cm / 4 1/4"

SSC-11-11-93
11.5 cm / 4 1/2"

SSC-11-11-94
13.0 cm / 5"

SSC-11-11-95
14.0 cm / 5 1/2"

SSC-11-11-96
15.5 cm / 6"

SSC-11-11-97
16.5 cm / 6 1/2"

SAWEEZ SAWEEZ SAWEEZ SAWEEZ



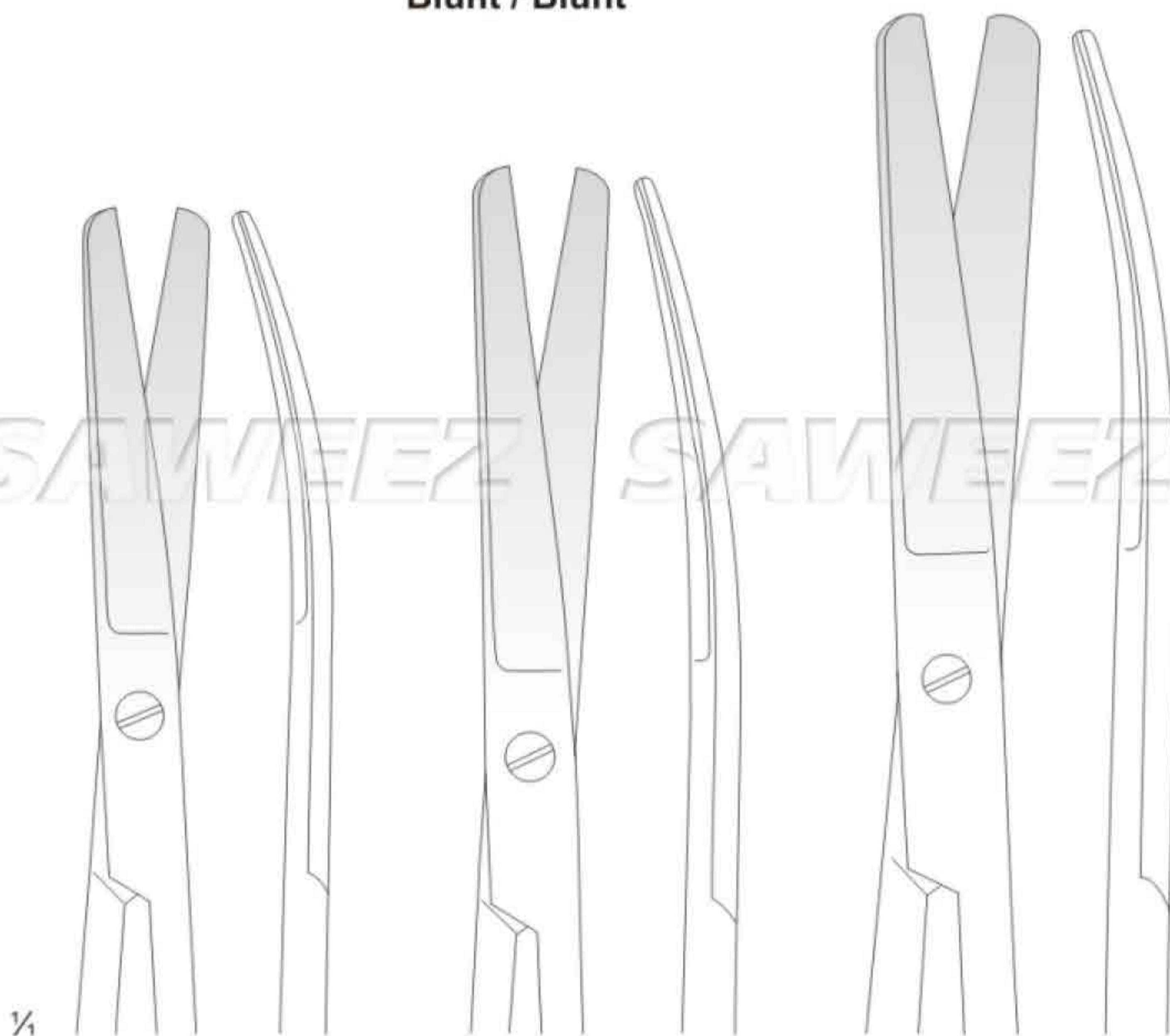
Blunt / Blunt

SAWEEZ

SAWEEZ

SAWEEZ

SAWEEZ



¼

SSC-11-11-98
11.5 cm / 4½"

SSC-11-11-99
13.0 cm / 5"

SSC-11-12-00
14.0 cm / 5½"

SAWEEZ

SAWEEZ

SAWEEZ

SAWEEZ

SAWEEZ

SAWEEZ

SAWEEZ

SAWEEZ



Standard

¼

SSC-11-12-01
15.5 cm / 6"

SSC-11-12-02
16.5 cm / 6½"

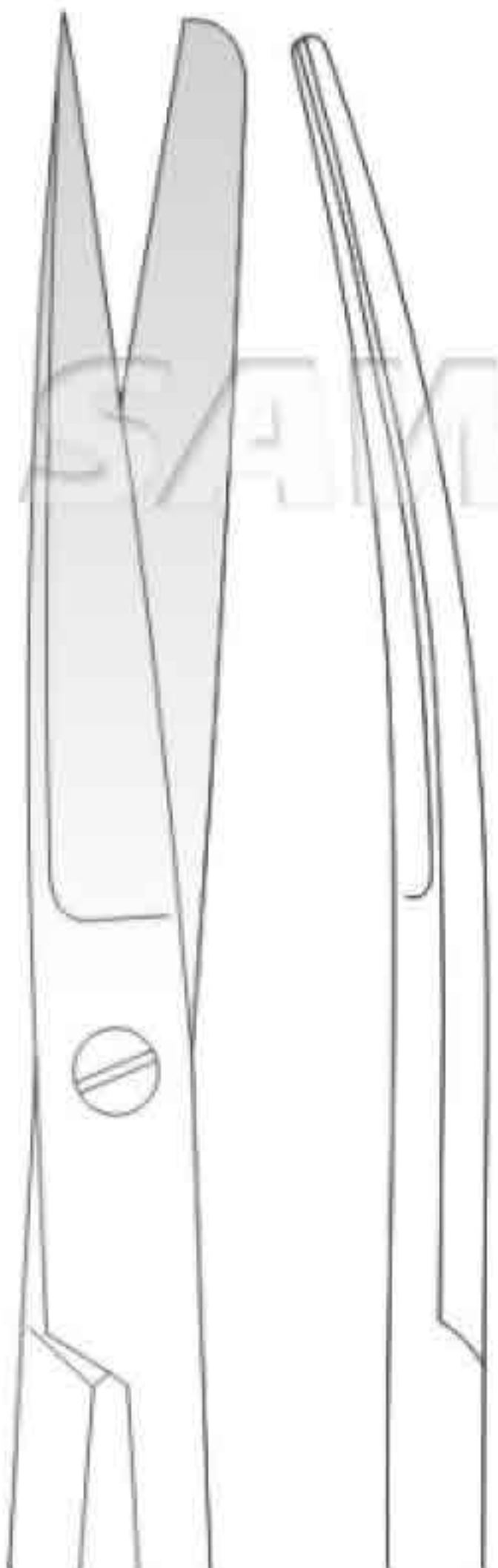
SSC-11-12-03
18.5 cm / 6¾"

SSC-11-12-04
20.0 cm / 8"



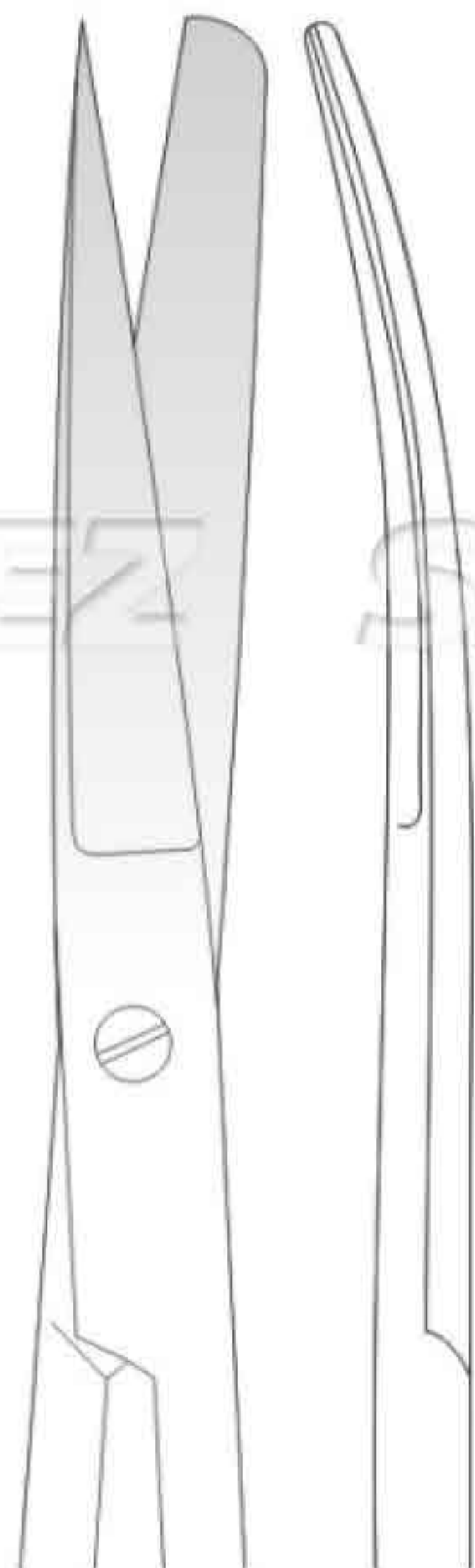
Sharp / Blunt

SAWEEZ

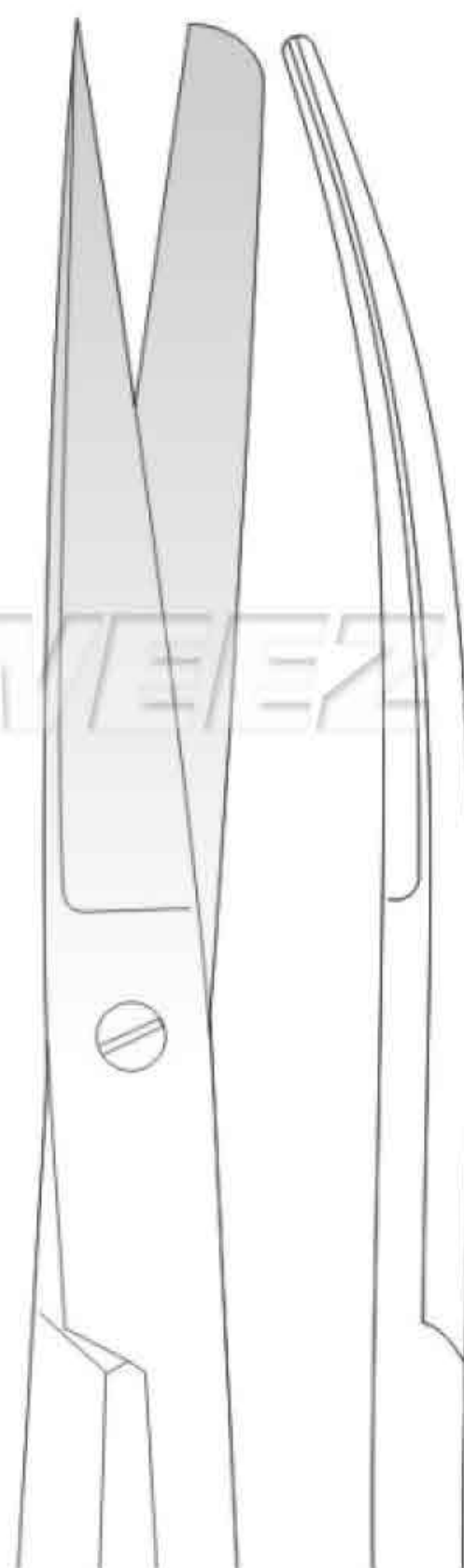


¼

SSC-11-12-05
11.5 cm / 4¼"



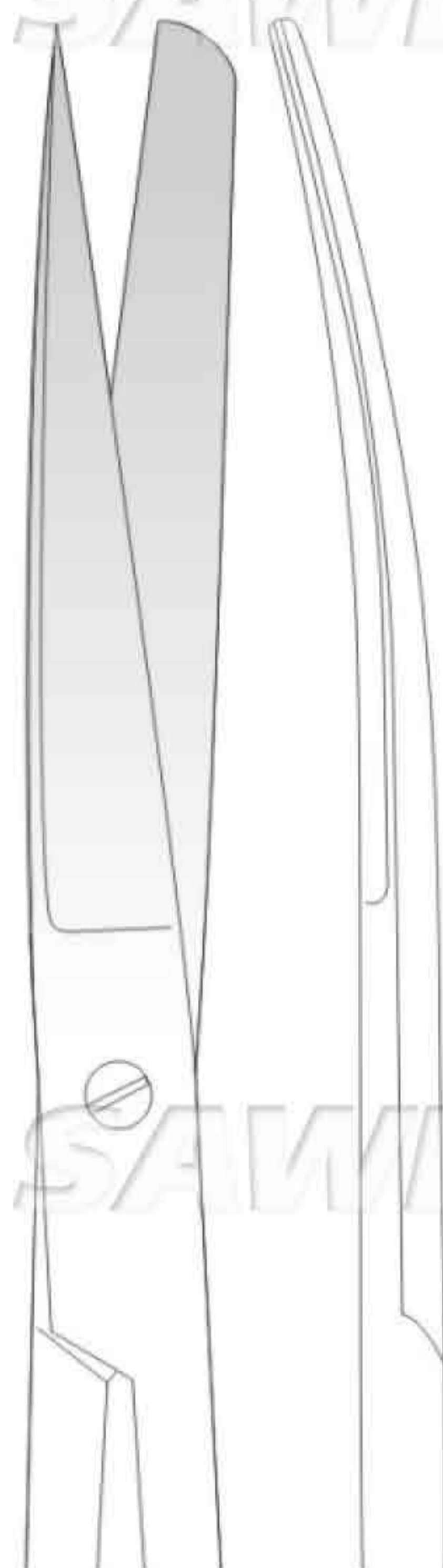
SSC-11-12-06
13.0 cm / 5"



SSC-11-12-07
14.0 cm / 5½"

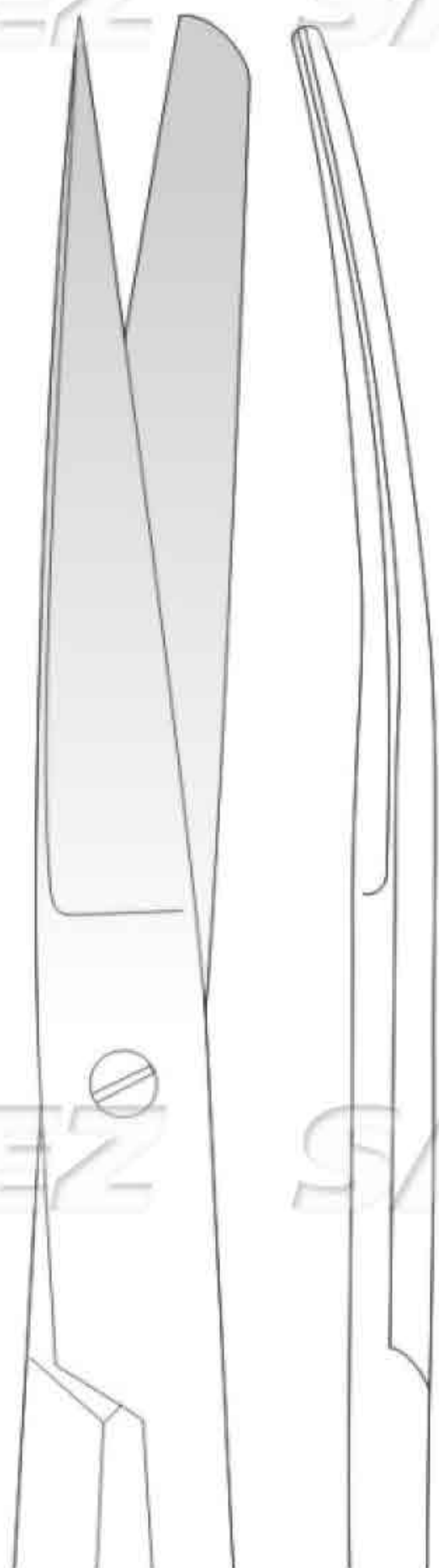
SAWEEZ

SAWEEZ

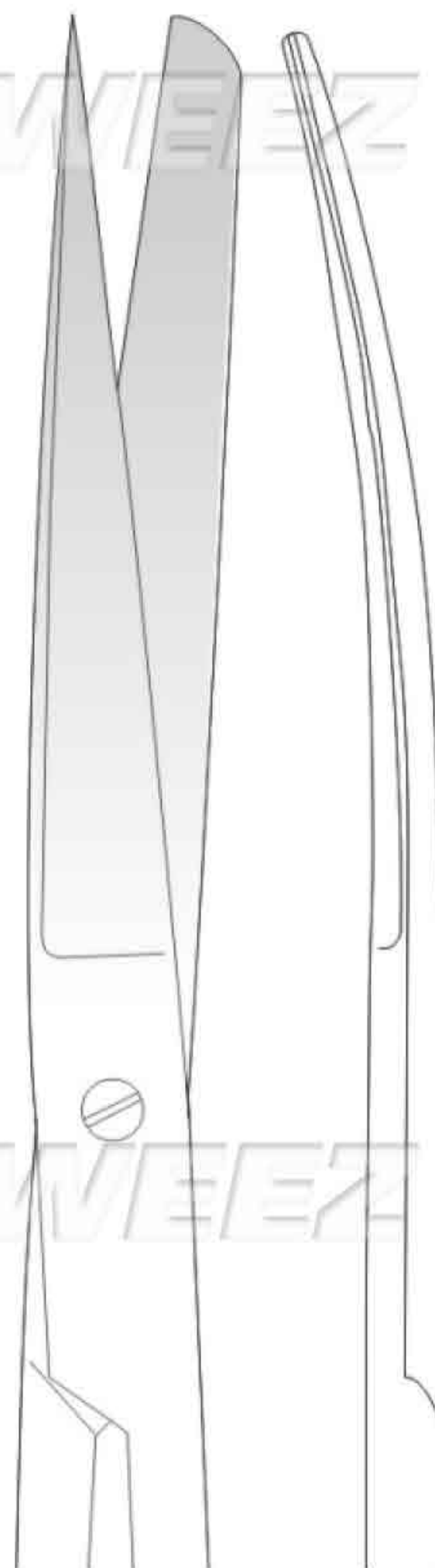


¼

SSC-11-12-08
15.5 cm / 6"

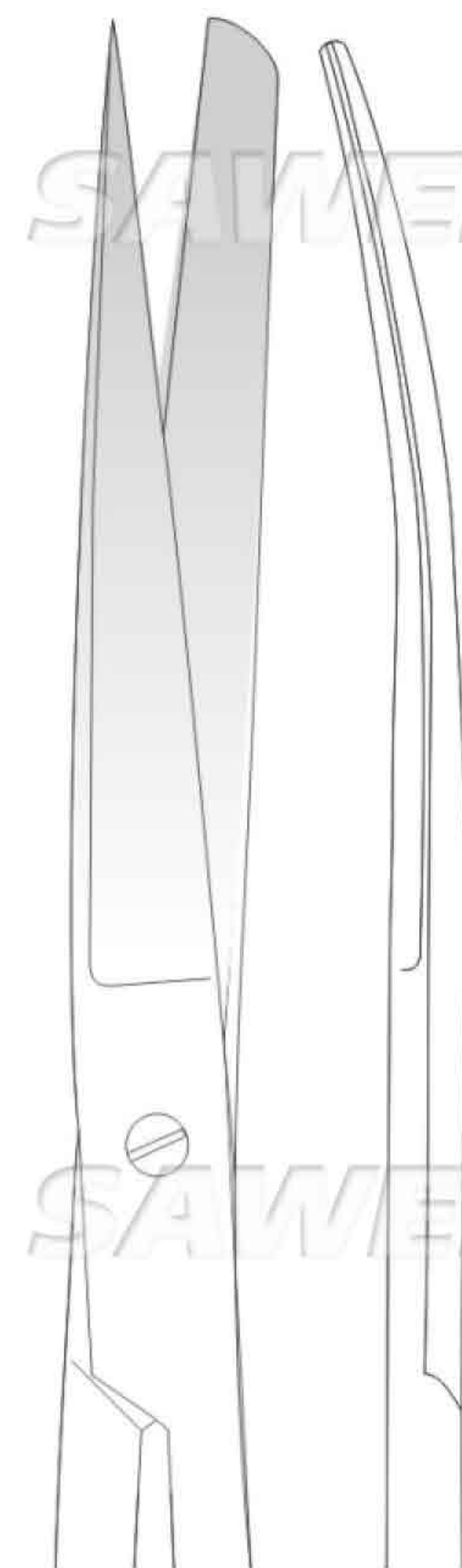


SSC-11-12-09
16.5 cm / 6½"



SSC-11-12-10
18.5 cm / 7¼"

SAWEEZ



SSC-11-12-11
20.0 cm / 8"

SAWEEZ



Standard



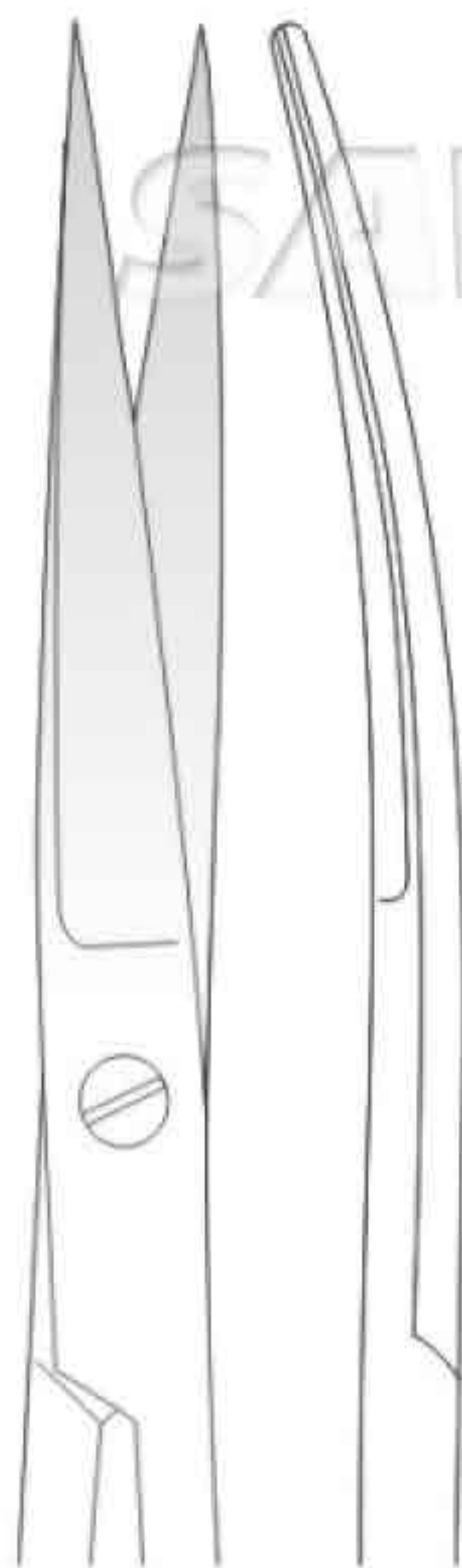
SAWEEZ SAWEEZ SAWEEZ SAWEEZ

Sharp / Sharp

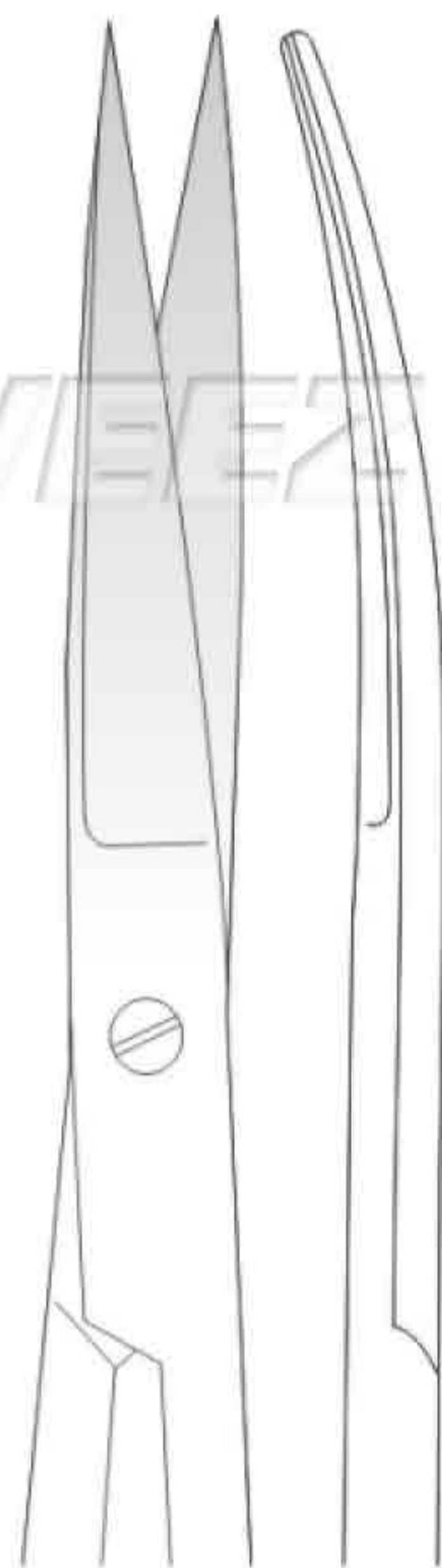


Standard

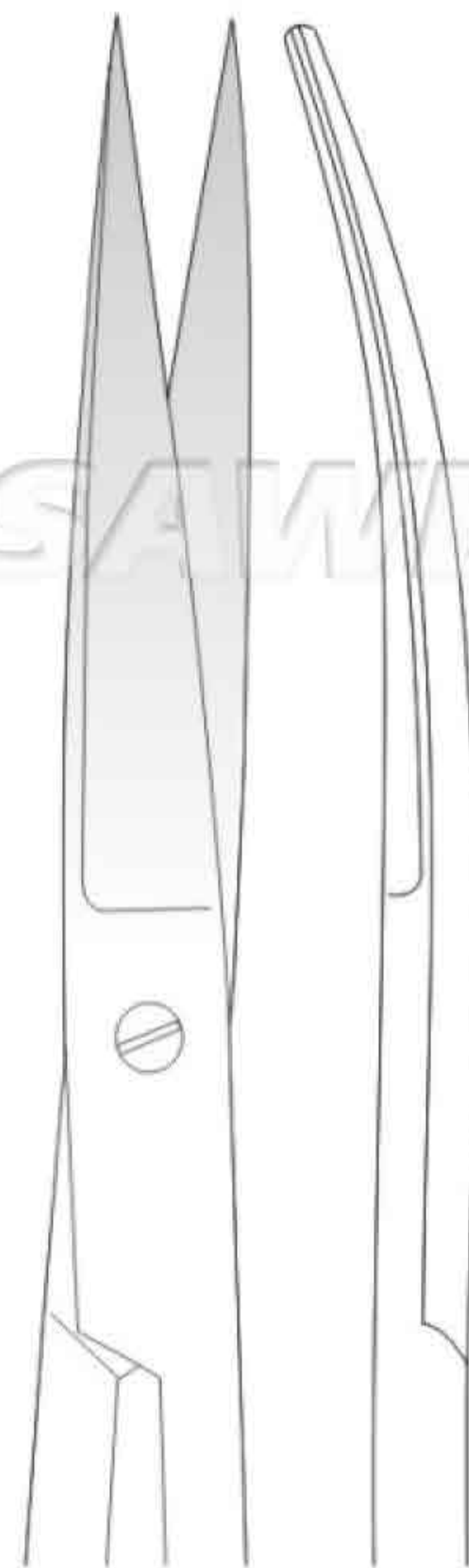
1/4



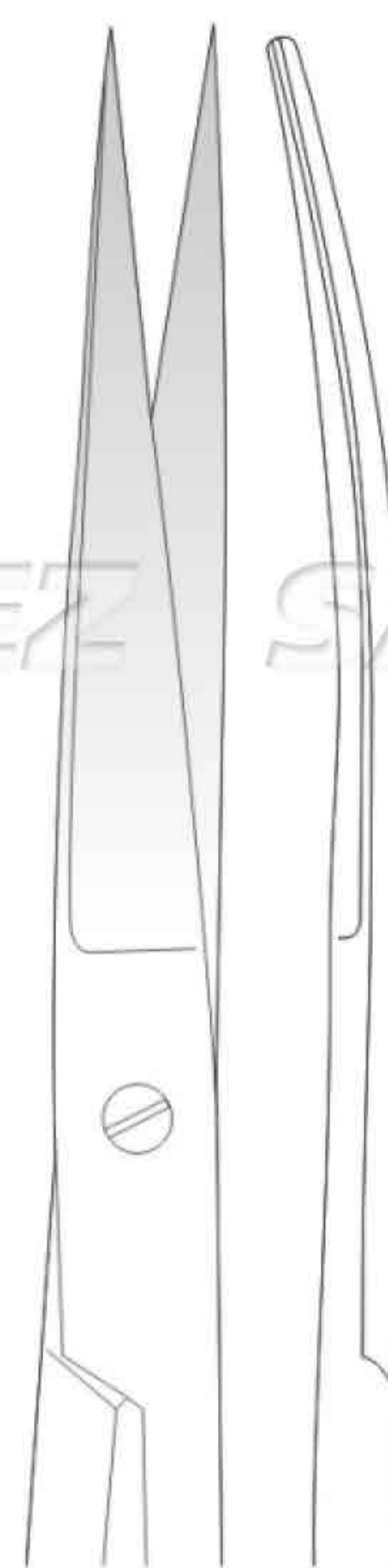
SSC-11-12-12
11.5 cm / 4 1/2"



SSC-11-12-13
13.0 cm / 5"



SSC-11-12-14
14.0 cm / 5 1/2"



SSC-11-12-15
15.5 cm / 6"

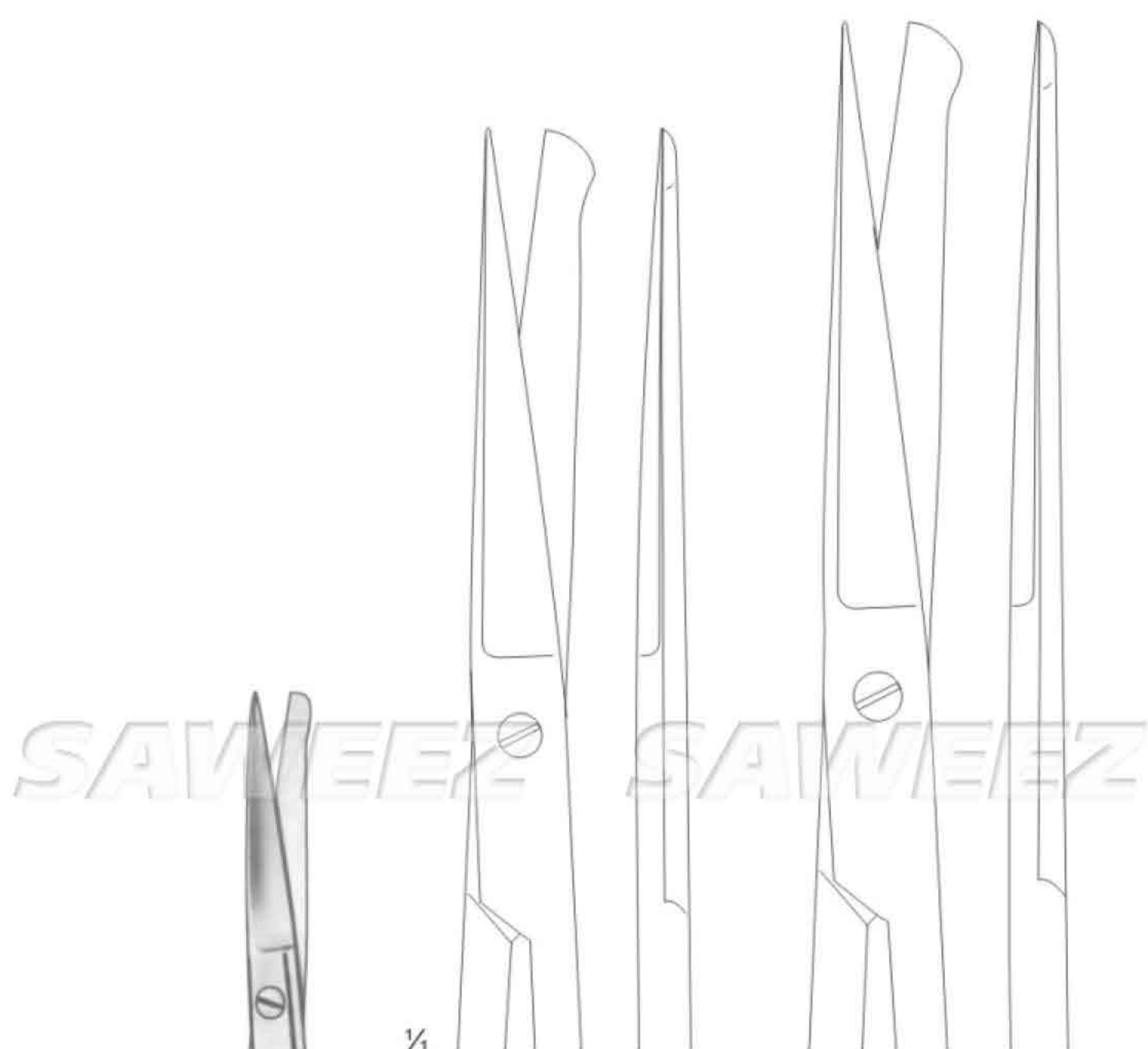


SSC-11-12-16
16.5 cm / 6 1/2"

SAWEEZ SAWEEZ SAWEEZ SAWEEZ

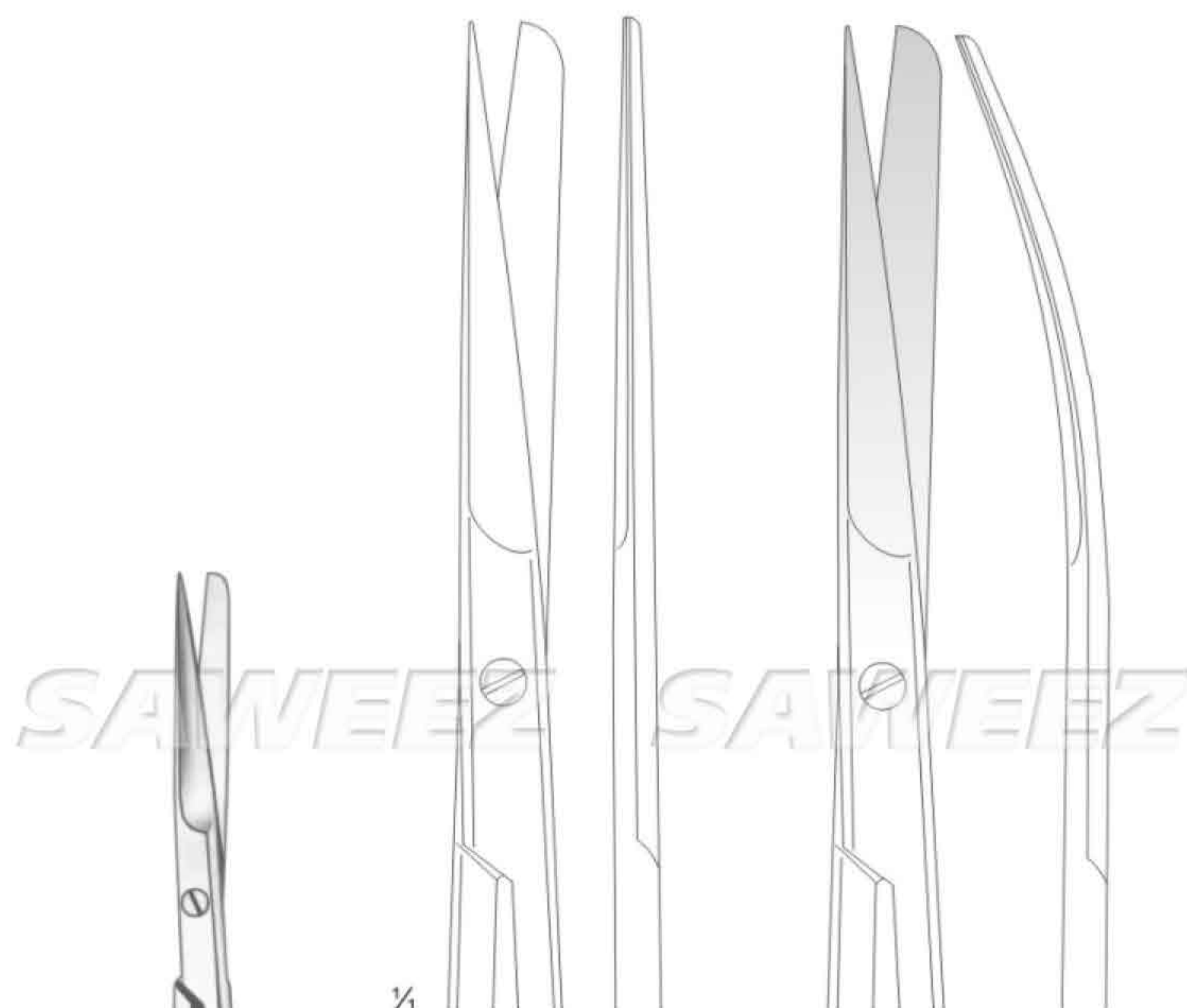


SAWEEZ SAWEEZ SAWEEZ SAWEEZ



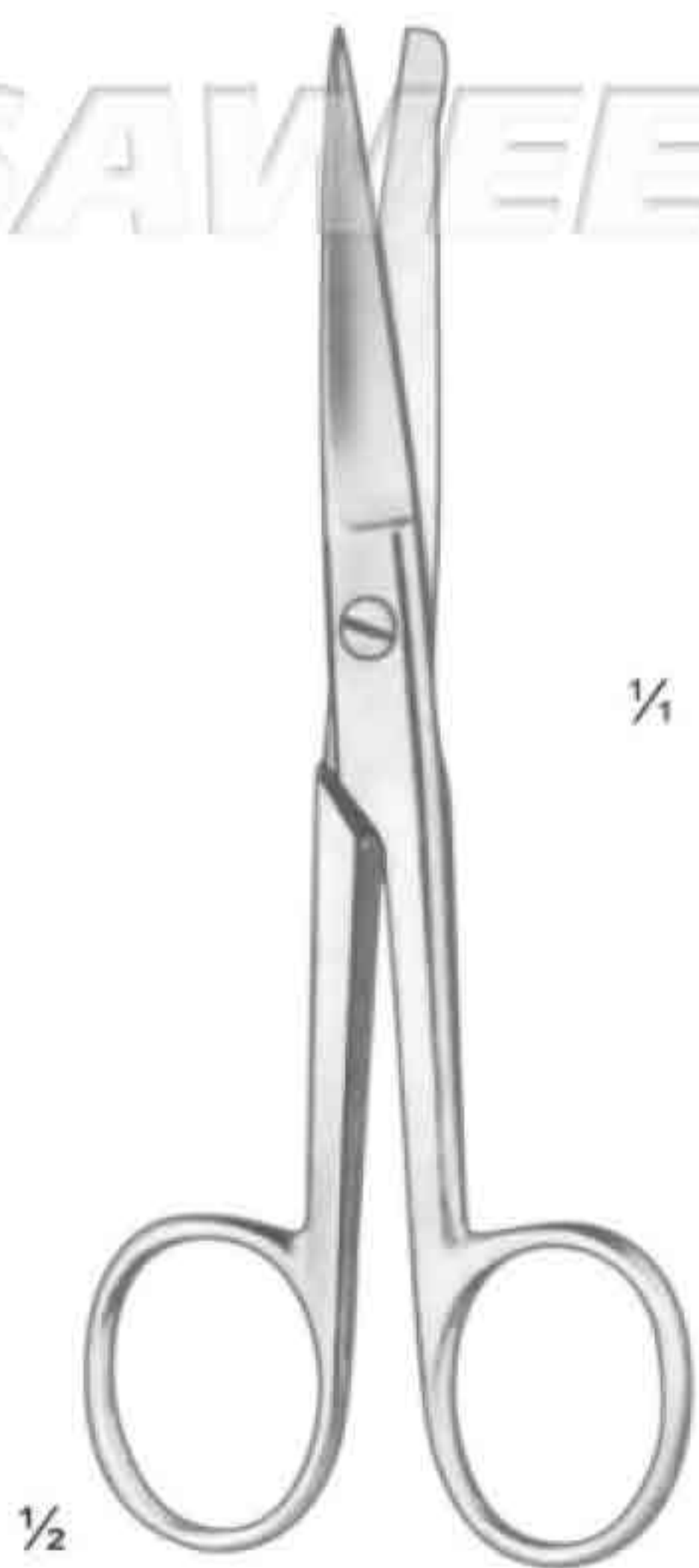
SSC-11-12-17
13.0 cm / 5"

SSC-11-12-18
14.0 cm / 5½"

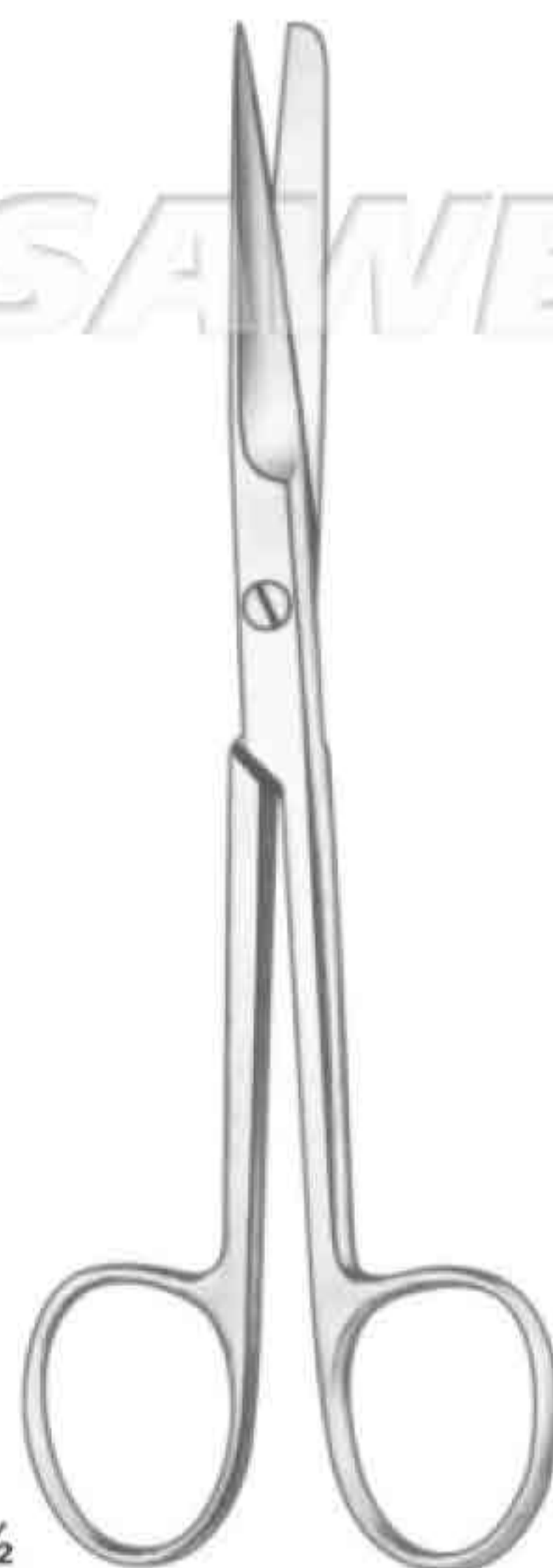


SSC-11-12-19
14.0 cm / 5½"

SSC-11-12-20
14.0 cm / 5½"

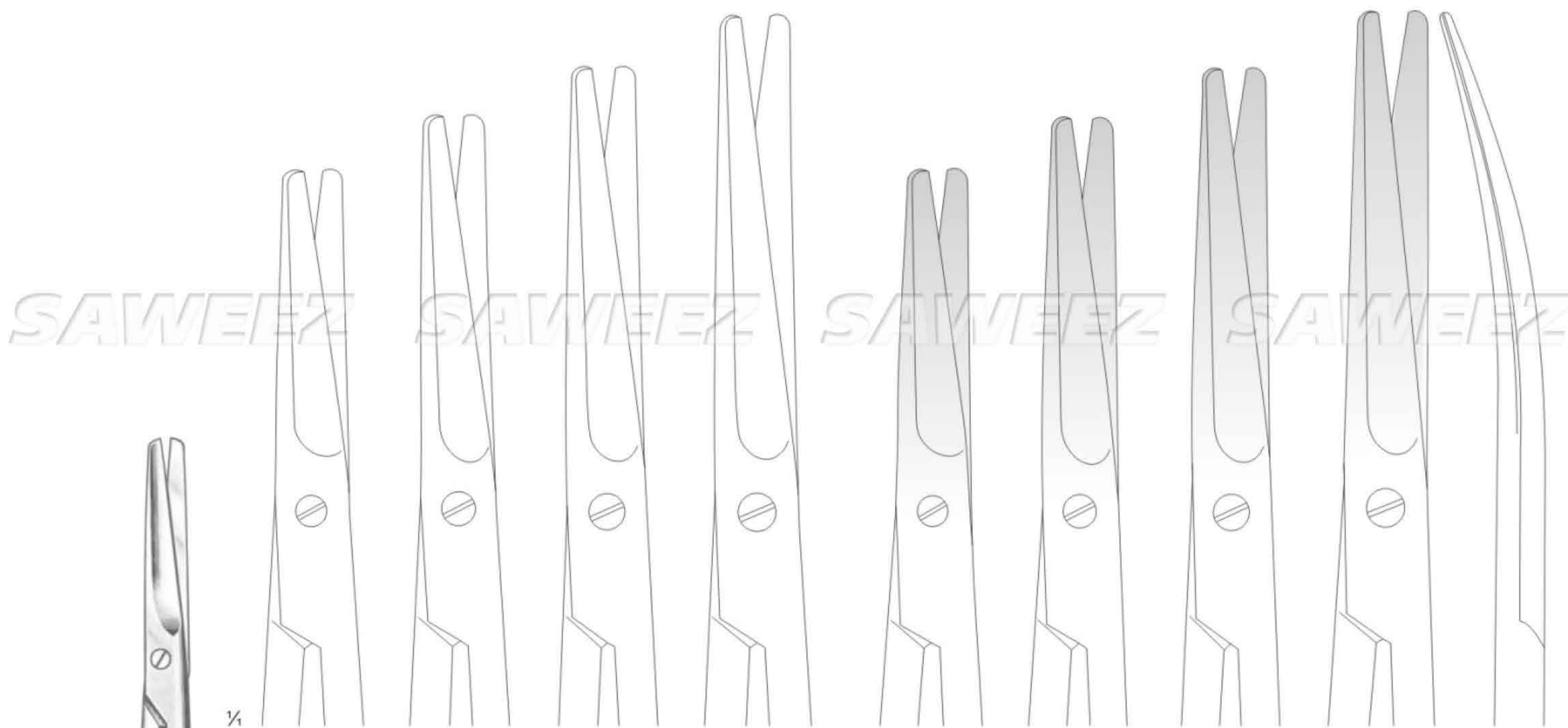


Incision Scissors



Deaver

SAWEEZ SAWEEZ SAWEEZ SAWEEZ



SSC-11-12-21 14.0 cm / 5½" SSC-11-12-22 15.0 cm / 6" SSC-11-12-23 17.0 cm / 6¾" SSC-11-12-24 23.0 cm / 9" SSC-11-12-25 14.0 cm / 5½" SSC-11-12-26 15.0 cm / 6" SSC-11-12-27 17.0 cm / 6¾" SSC-11-12-28 23.0 cm / 9"



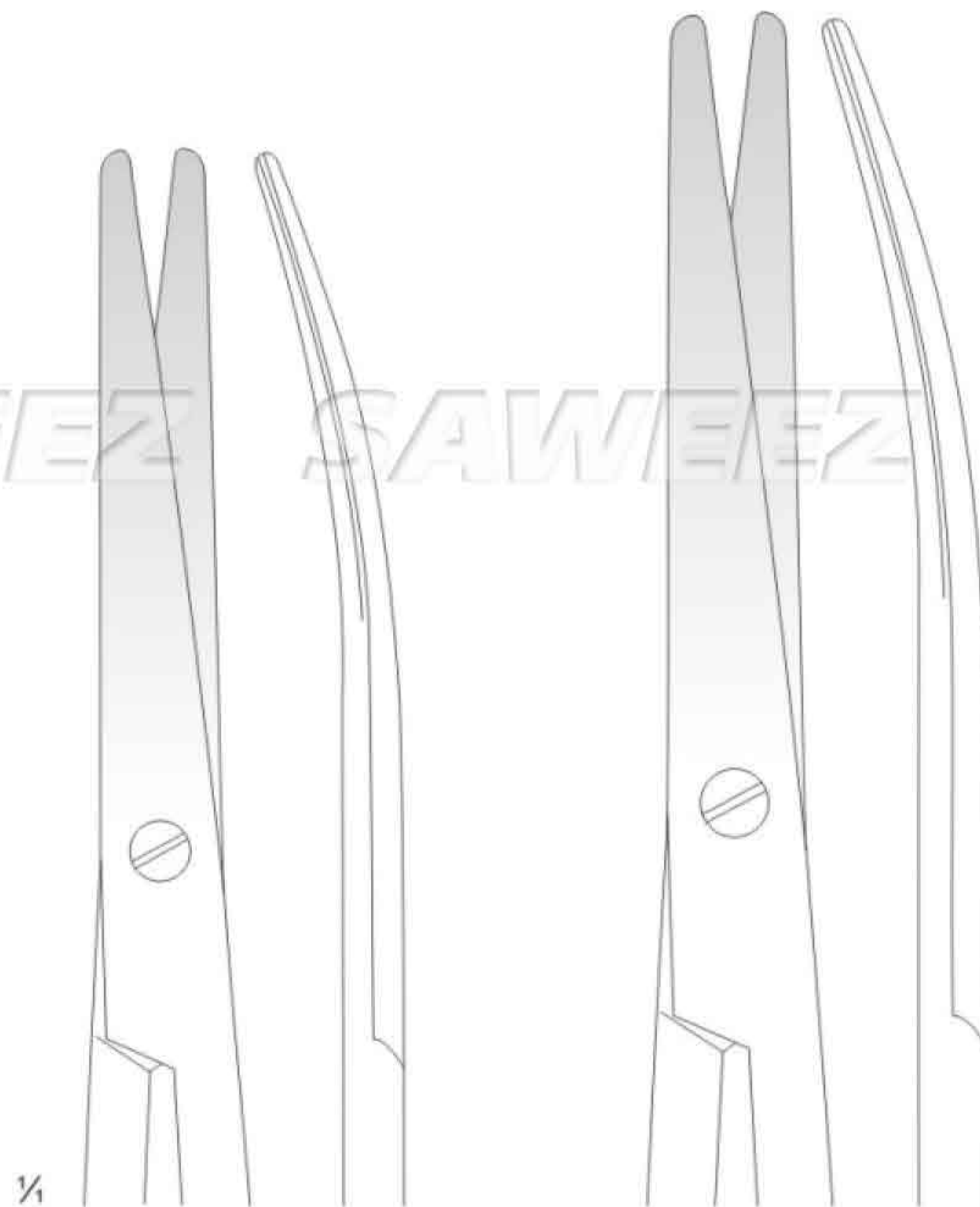
Mayo

Mayo-Harrington

SSC-11-12-29 22.5 cm / 9" SSC-11-12-30 22.5 cm / 9" SSC-11-12-31 30.0 cm / 12"



SAWEEZ SAWEEZ SAWEEZ SAWEEZ



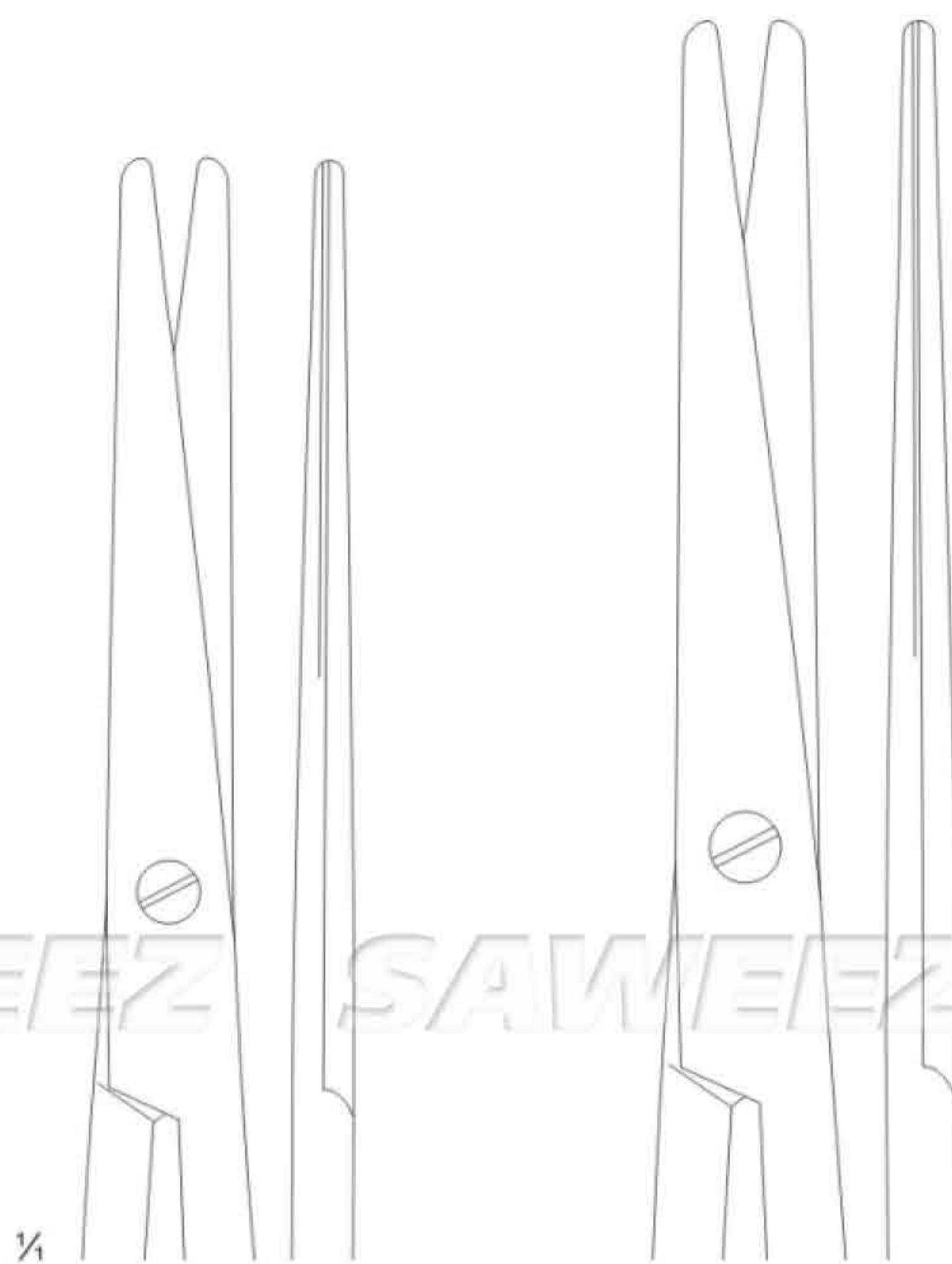
SSC-11-12-32
15.0 cm / 6"

SSC-11-12-33
17.0 cm / 6 3/4"

SAWEEZ SAWEEZ SAWEEZ SAWEEZ



Mayo-Stille



SSC-11-12-34
15.0 cm / 6"

SSC-11-12-35
17.0 cm / 6 3/4"

SAWEEZ SAWEEZ SAWEEZ SAWEEZ



SAWEEZ

SAWEEZ

SAWEEZ

SAWEEZ



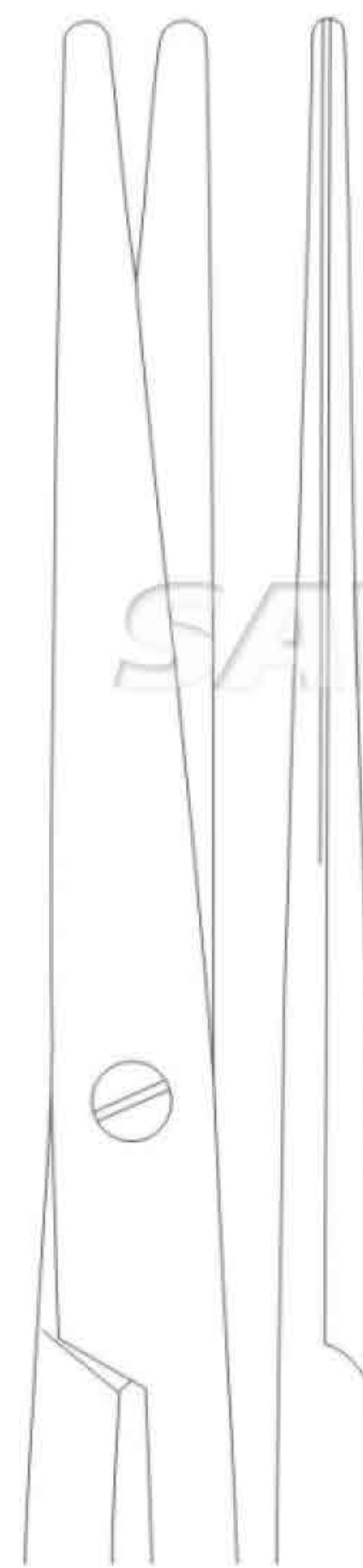
1/4

SSC-11-12-36
16.0 cm / 6 1/4"



1/4

SSC-11-12-37
19.0 cm / 7 1/2"



1/4

SSC-11-12-38
21.0 cm / 8 1/4"

SAWEEZ

SAWEEZ

SAWEEZ

SAWEEZ



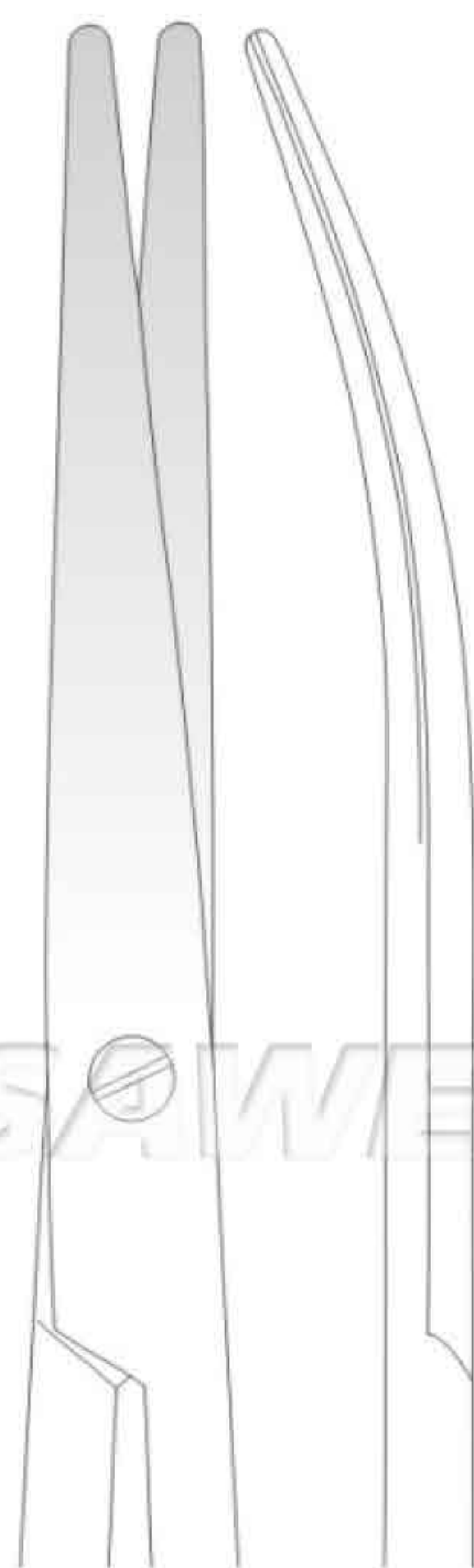
1/2

Mayo-Stille



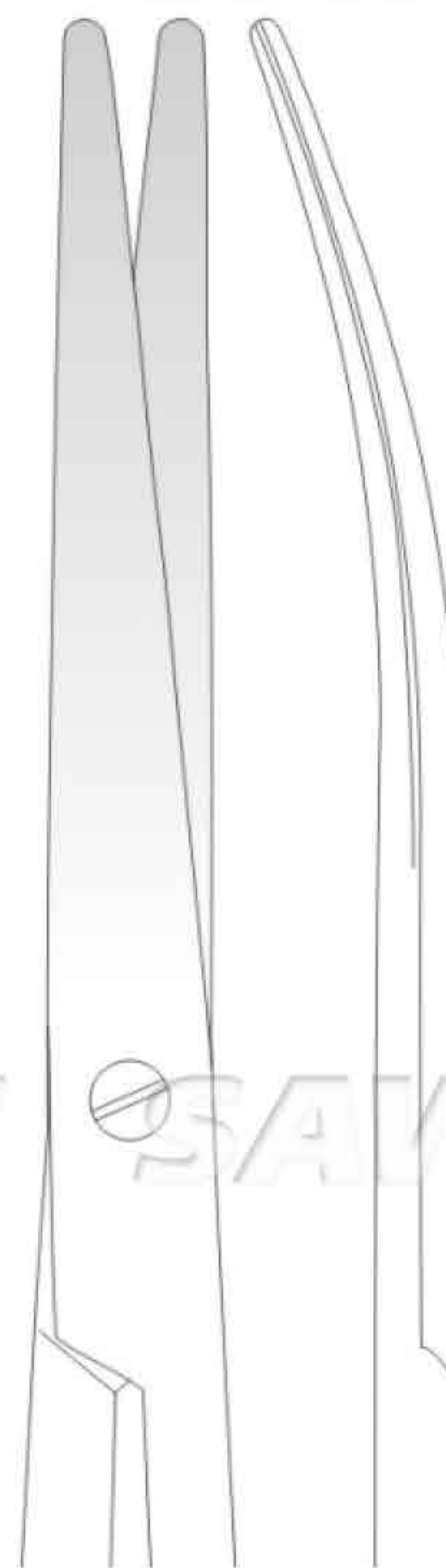
1/4

SSC-11-12-39
16.0 cm / 6 1/4"



1/4

SSC-11-12-40
19.0 cm / 7 1/2"



1/4

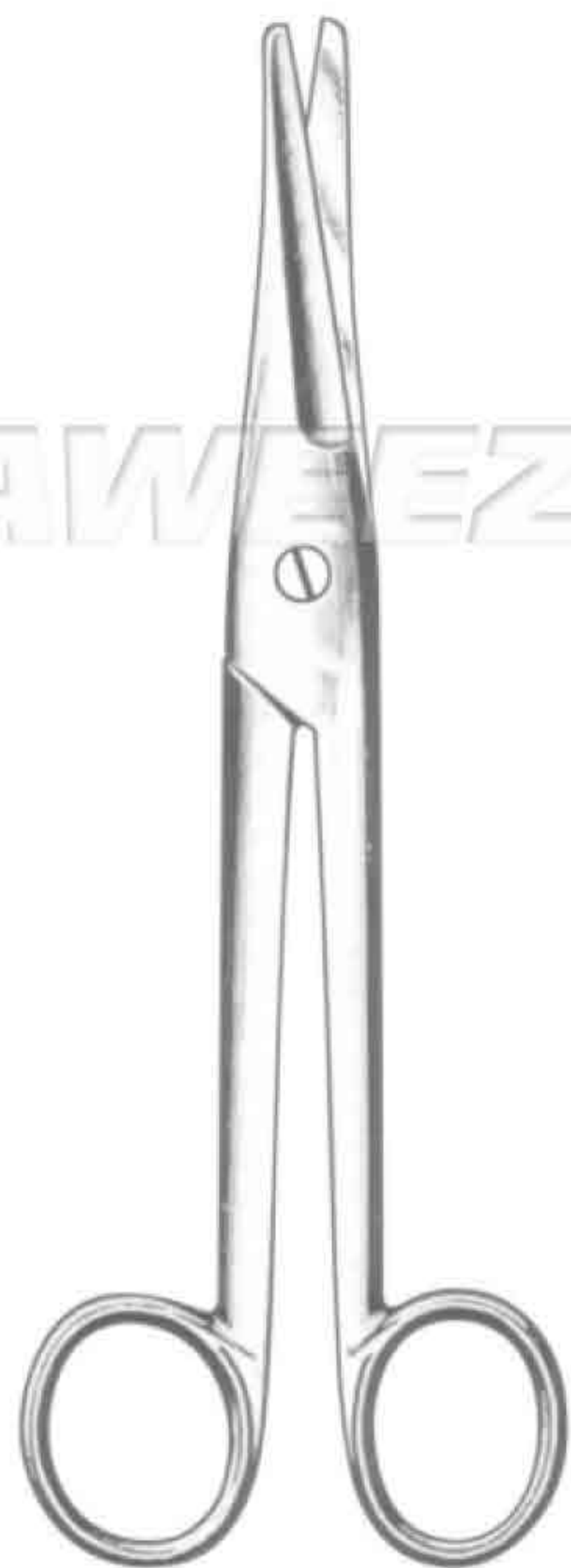
SSC-11-12-41
21.0 cm / 8 1/4"

SAWEEZ

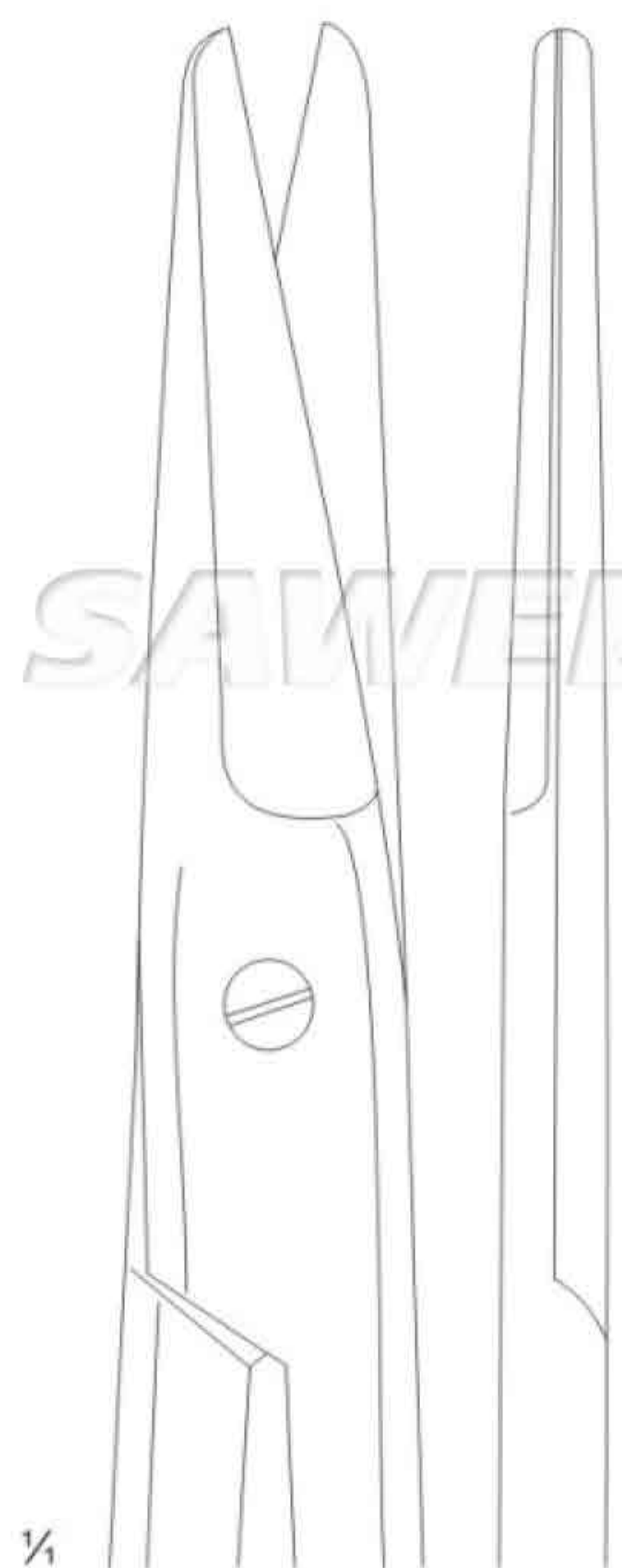
SAWEEZ

SAWEEZ

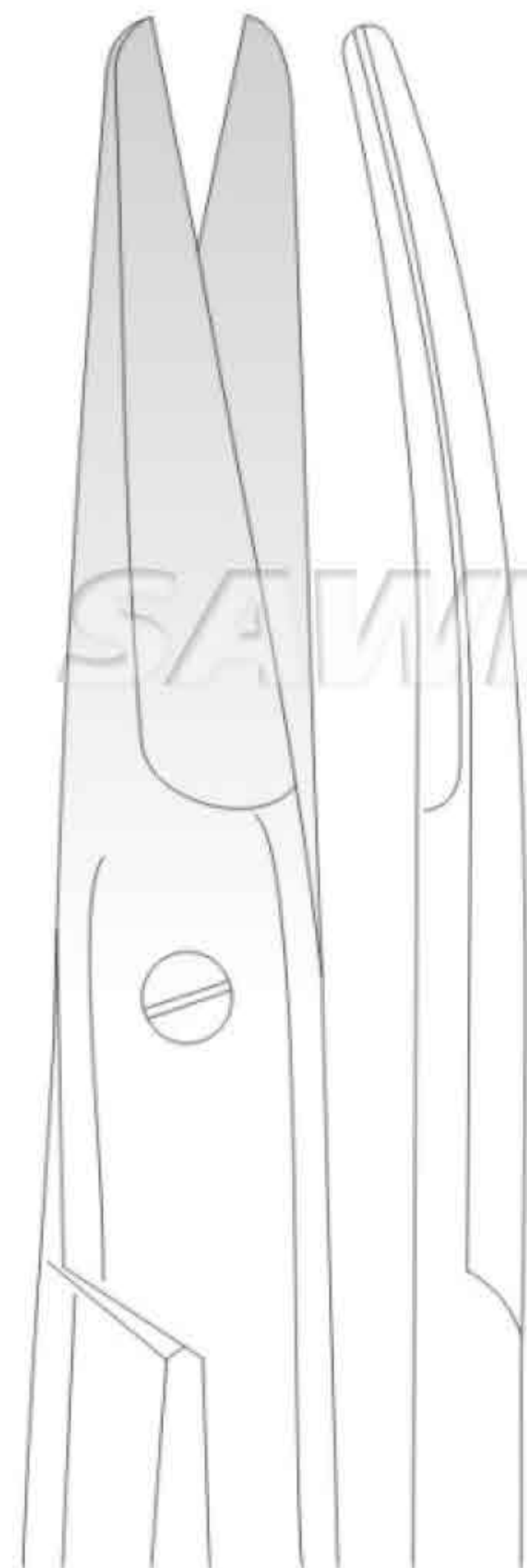
SAWEEZ



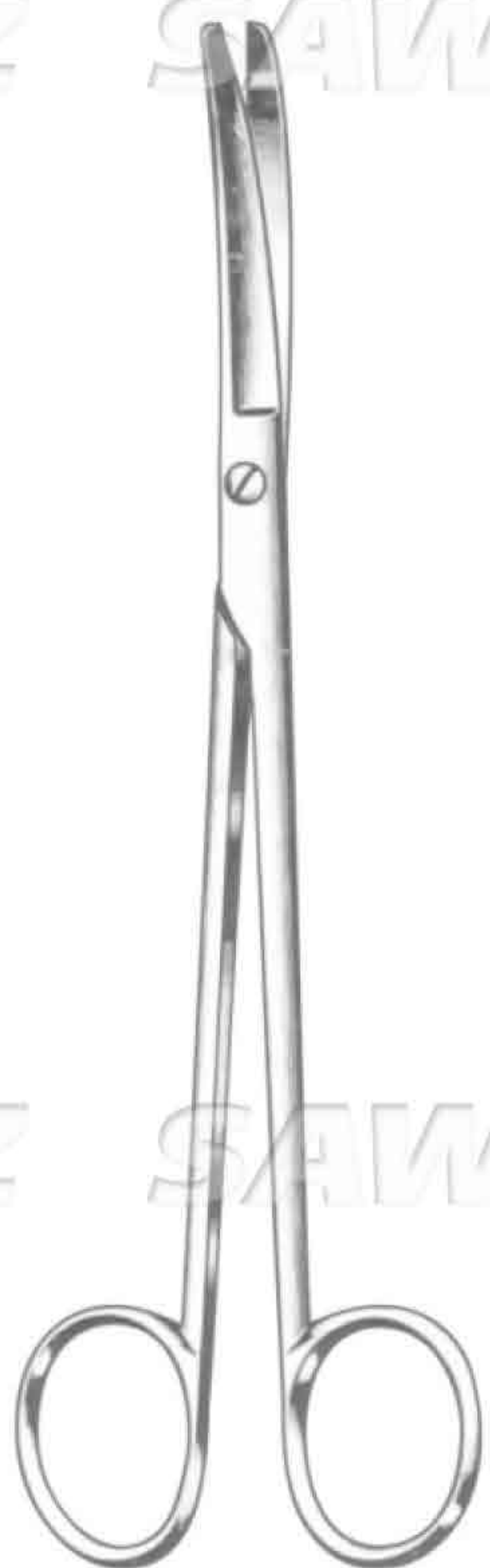
Mayo-Noble



SSC-11-12-42
17.0 cm / 6 3/4"



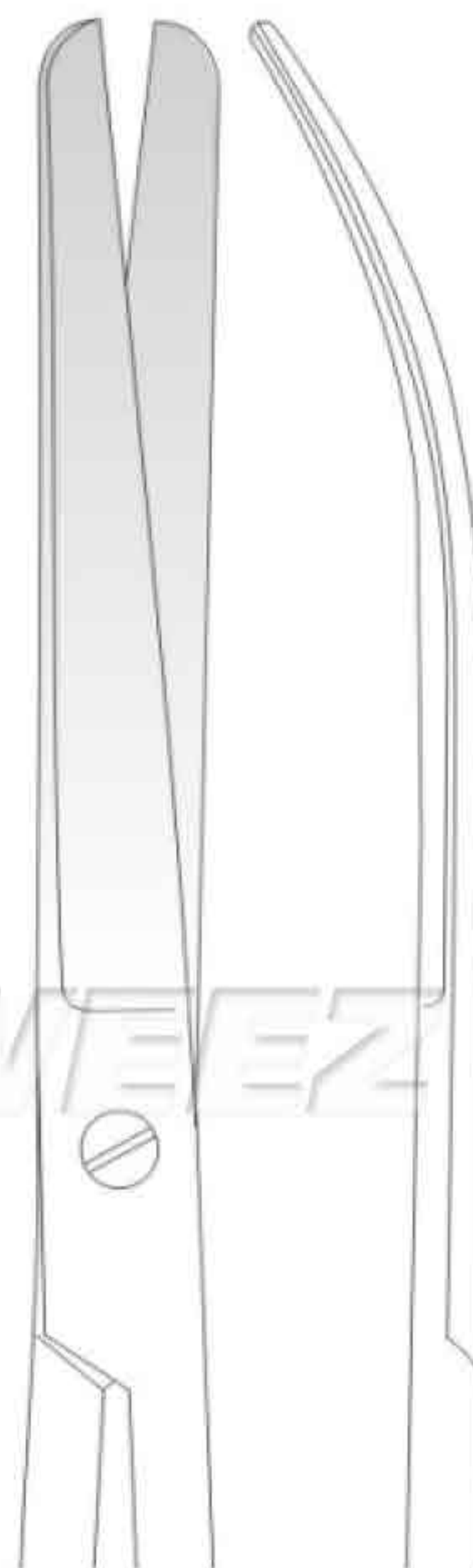
SSC-11-12-43
17.0 cm / 6 3/4"



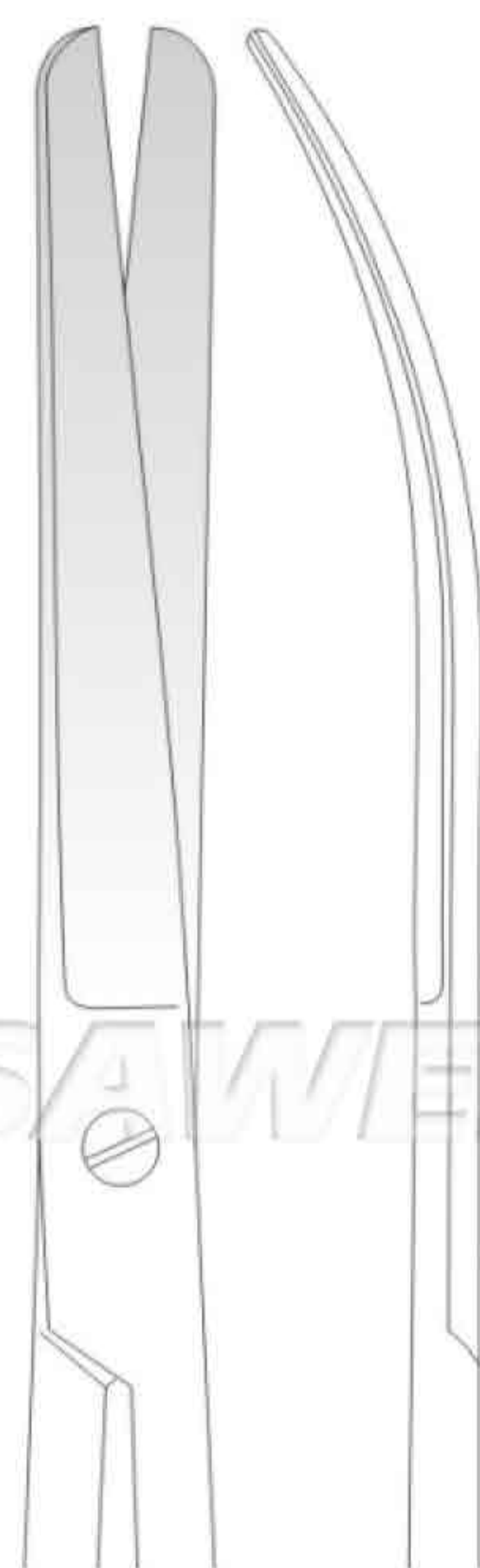
Wertheim



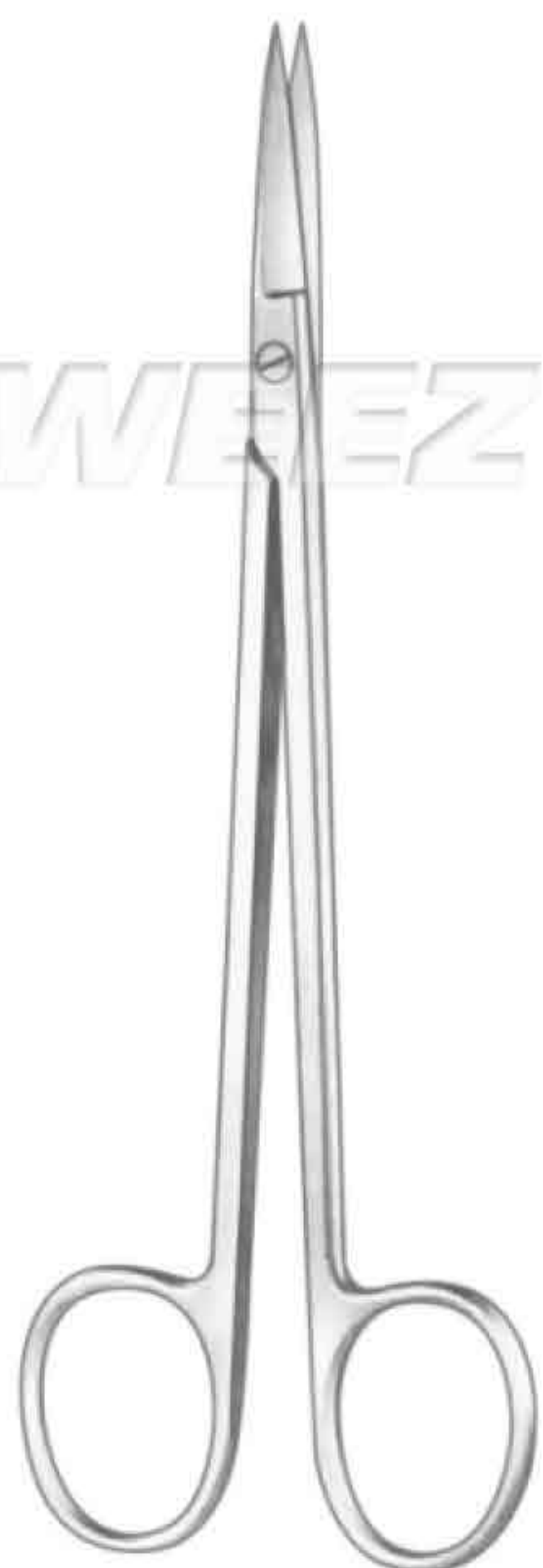
SSC-11-12-44
14.0 cm / 5 1/2"



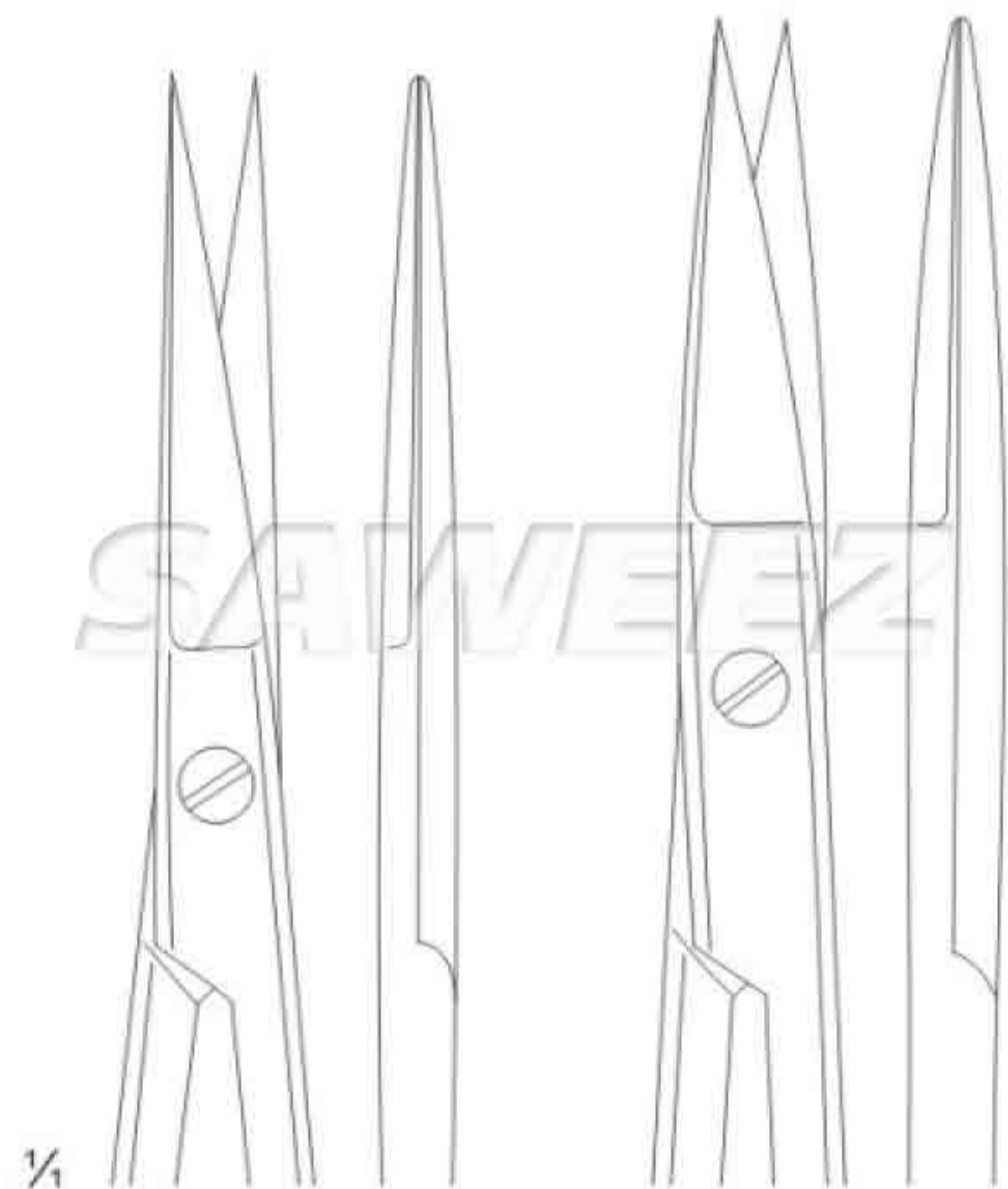
SSC-11-12-45
19.5 cm / 7 3/4"



SSC-11-12-46
22.5 cm / 9"

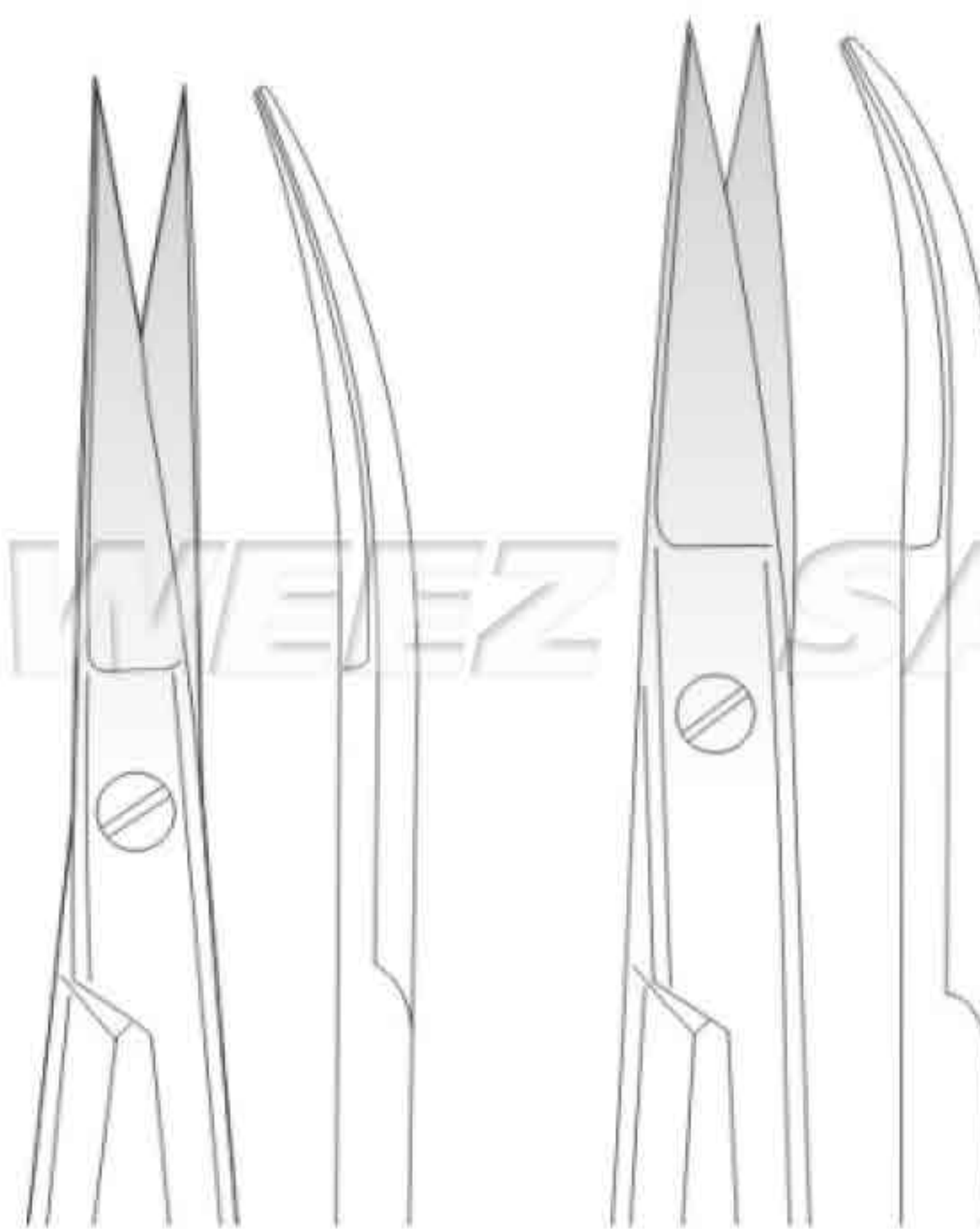


Kelly



SSC-11-12-47
16.0 cm / 6 1/4"

SSC-11-12-48
18.0 cm / 7"

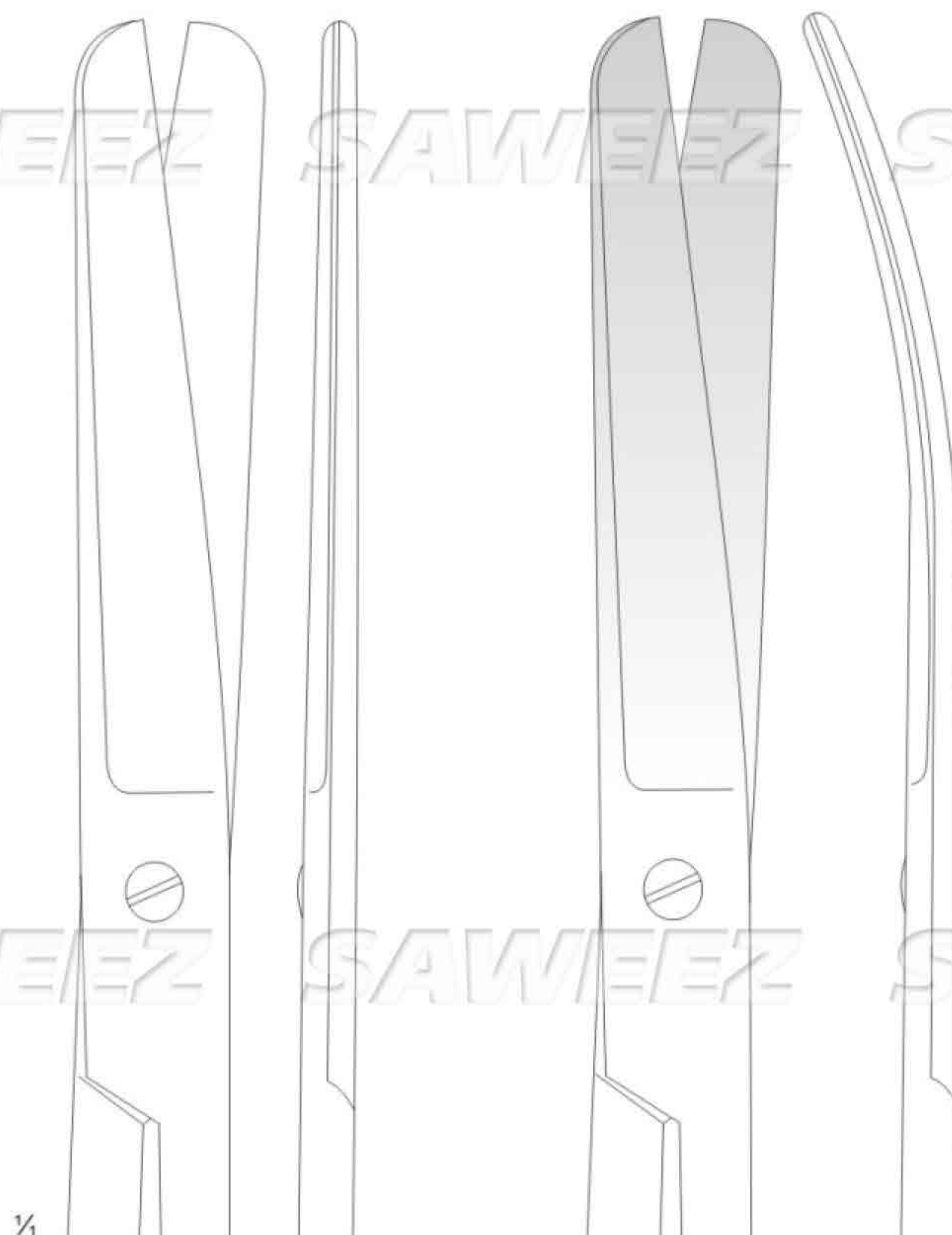


SSC-11-12-49
16.0 cm / 6 1/4"

SSC-11-12-50
18.0 cm / 7"



Doyen

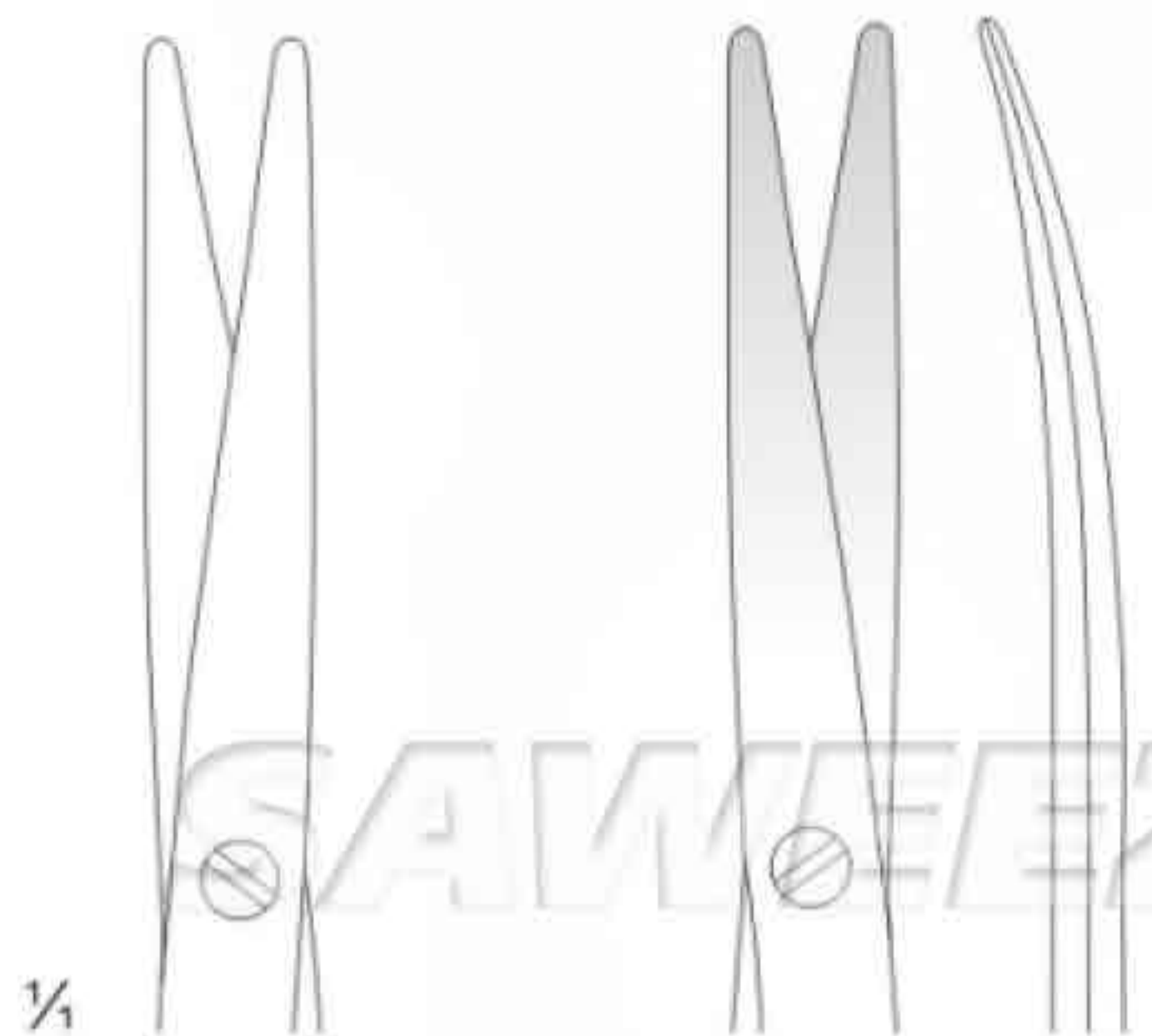


SSC-11-12-51
17.5 cm / 7"

SSC-11-12-52
17.0 cm / 6 3/4"

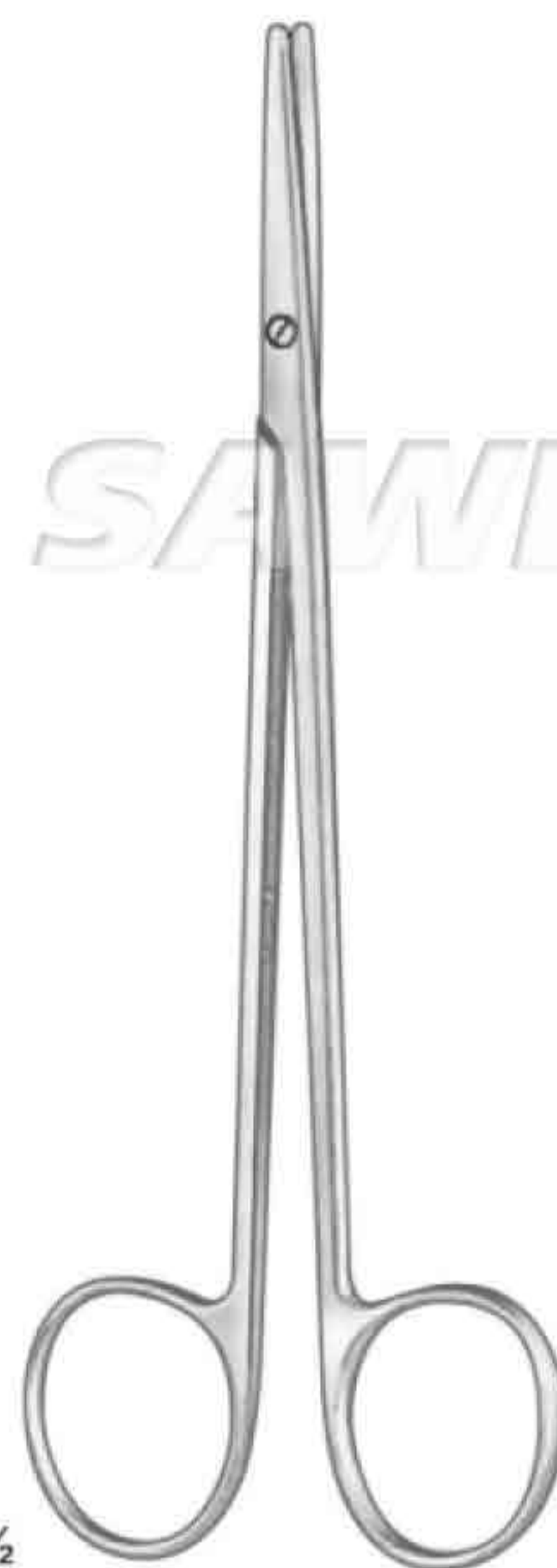


Metzenbaum

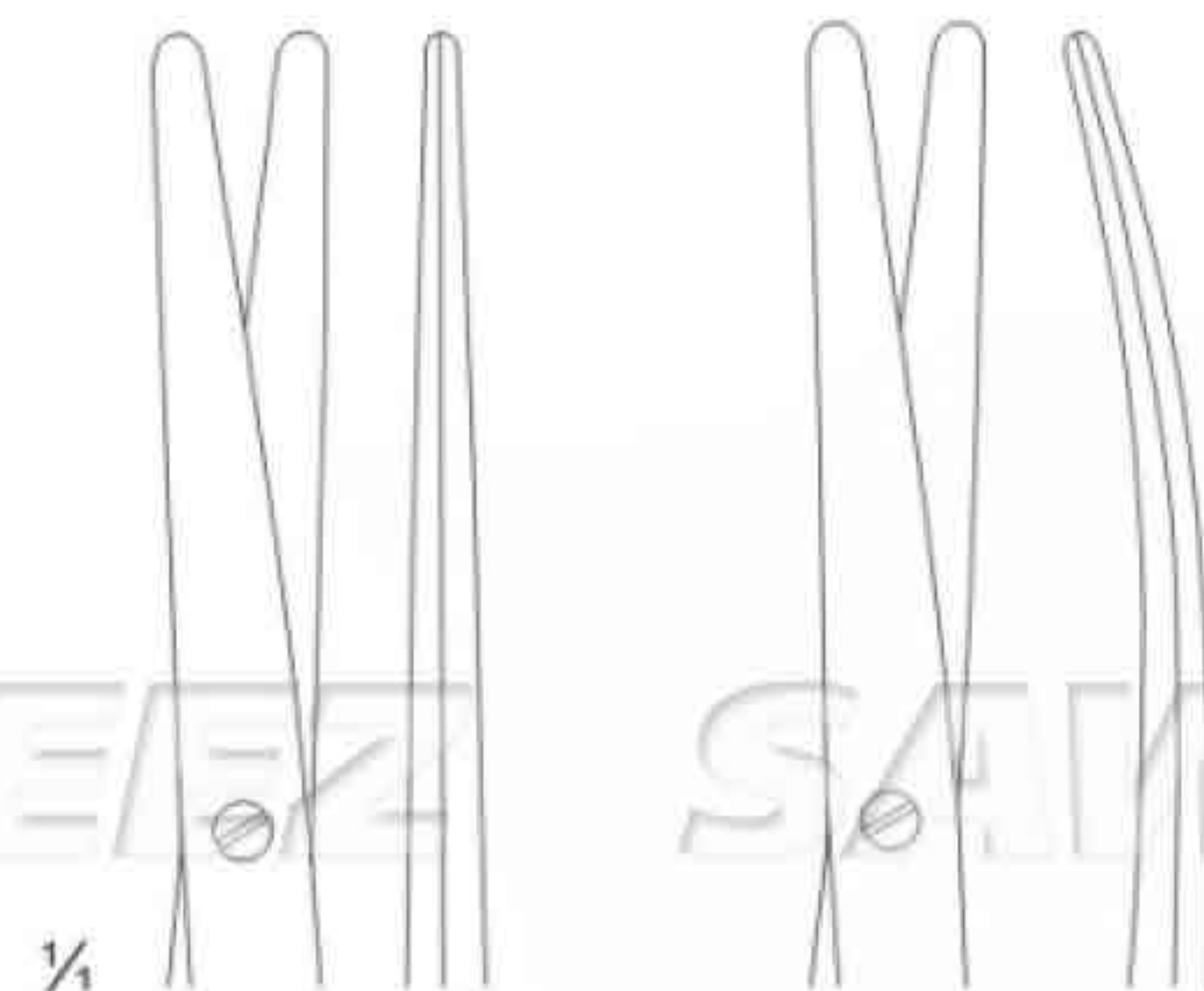


SSC-11-12-53
11.5 cm / 4 1/2"

SSC-11-12-54
11.5 cm / 4 1/2"



Metzenbaum

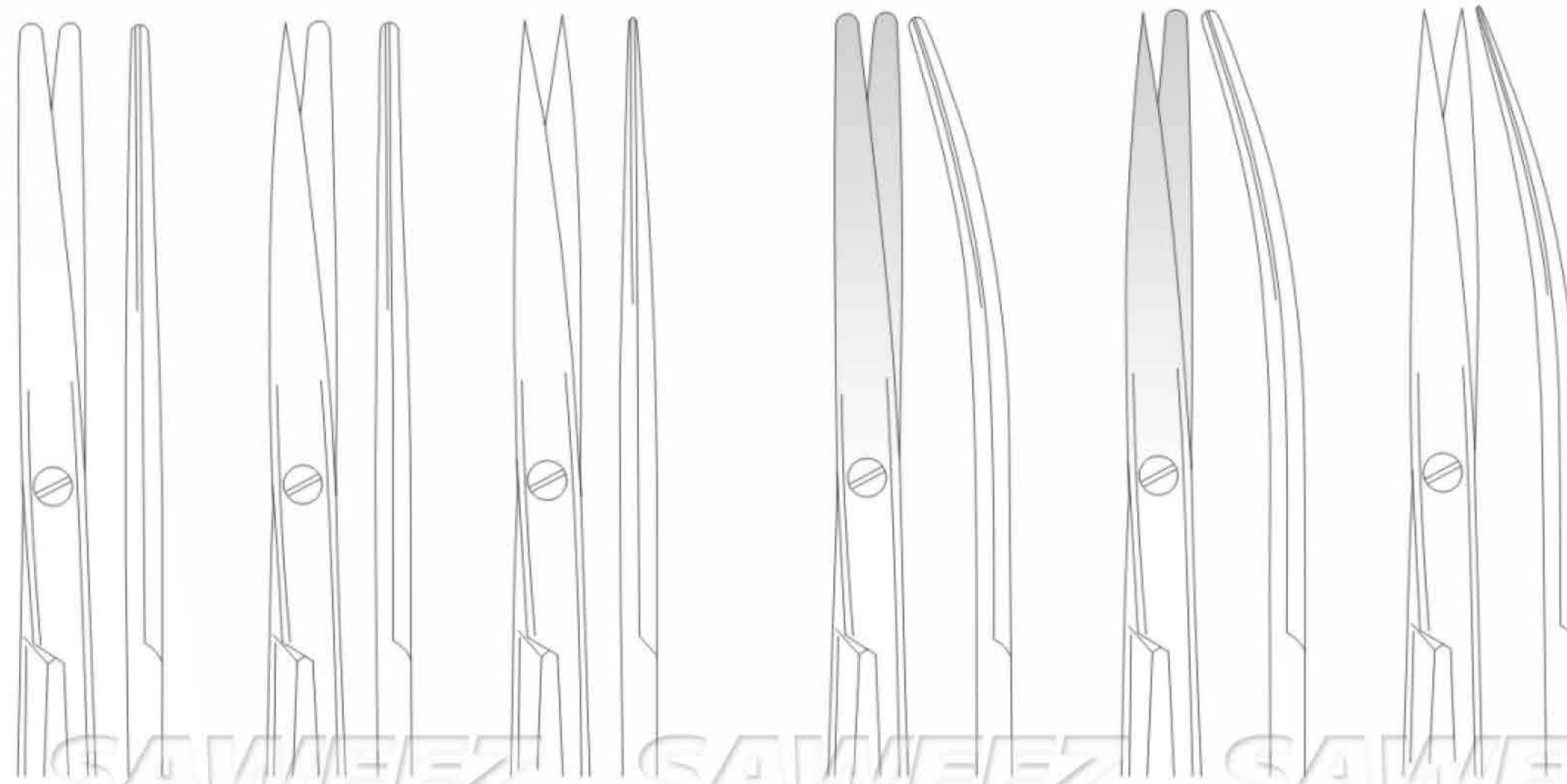


SSC-11-12-55
15.0 cm / 6"

SSC-11-12-56
15.0 cm / 6"



Metzenbaum



SSC-11-12-57
14.0 cm / 5 1/2"

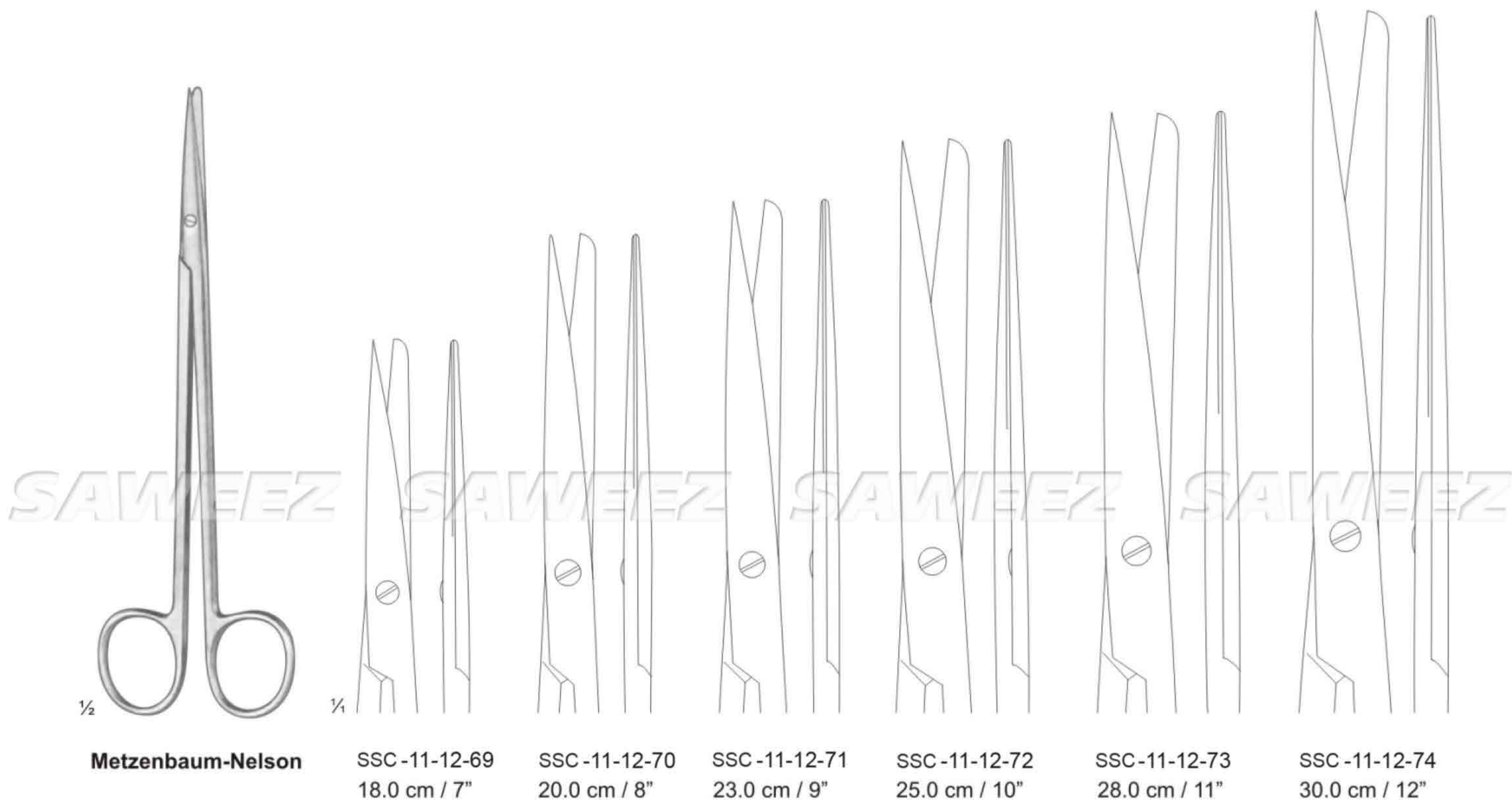
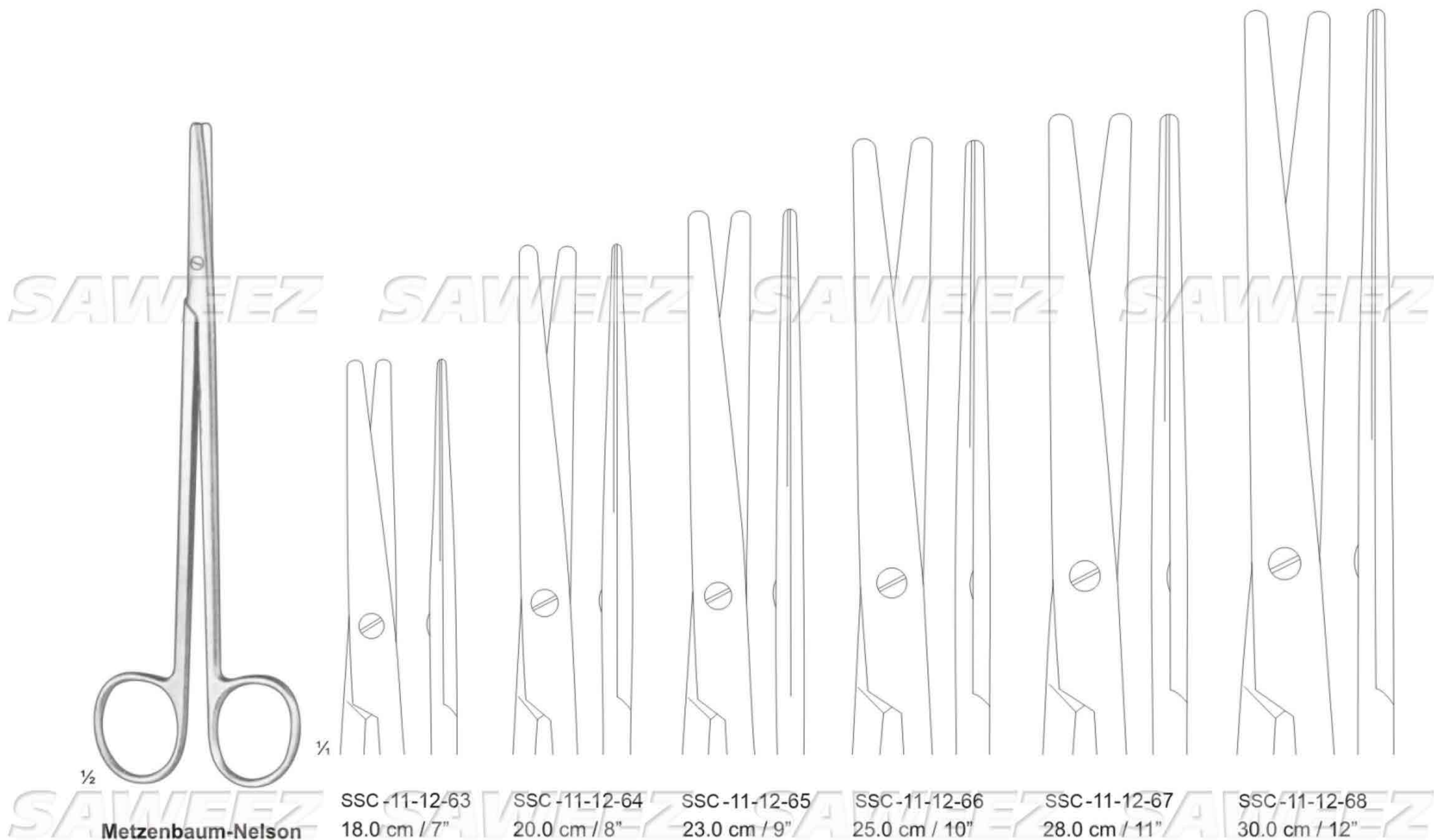
SSC-11-12-58
14.0 cm / 5 1/2"

SSC-11-12-59
14.0 cm / 5 1/2"

SSC-11-12-60
14.0 cm / 5 1/2"

SSC-11-12-61
14.0 cm / 5 1/2"

SSC-11-12-62
14.0 cm / 5 1/2"





SAWEEZ SAWEEZ SAWEEZ SAWEEZ

1/2

1/4

SSC -11-12-75 18.0 cm / 7" SSC -11-12-76 20.0 cm / 8" SSC -11-12-77 23.0 cm / 9" SSC -11-12-78 25.0 cm / 10" SSC -11-12-79 28.0 cm / 11" SSC -11-12-80 30.0 cm / 12"

Metzenbaum-Nelson

SAWEEZ SAWEEZ SAWEEZ SAWEEZ

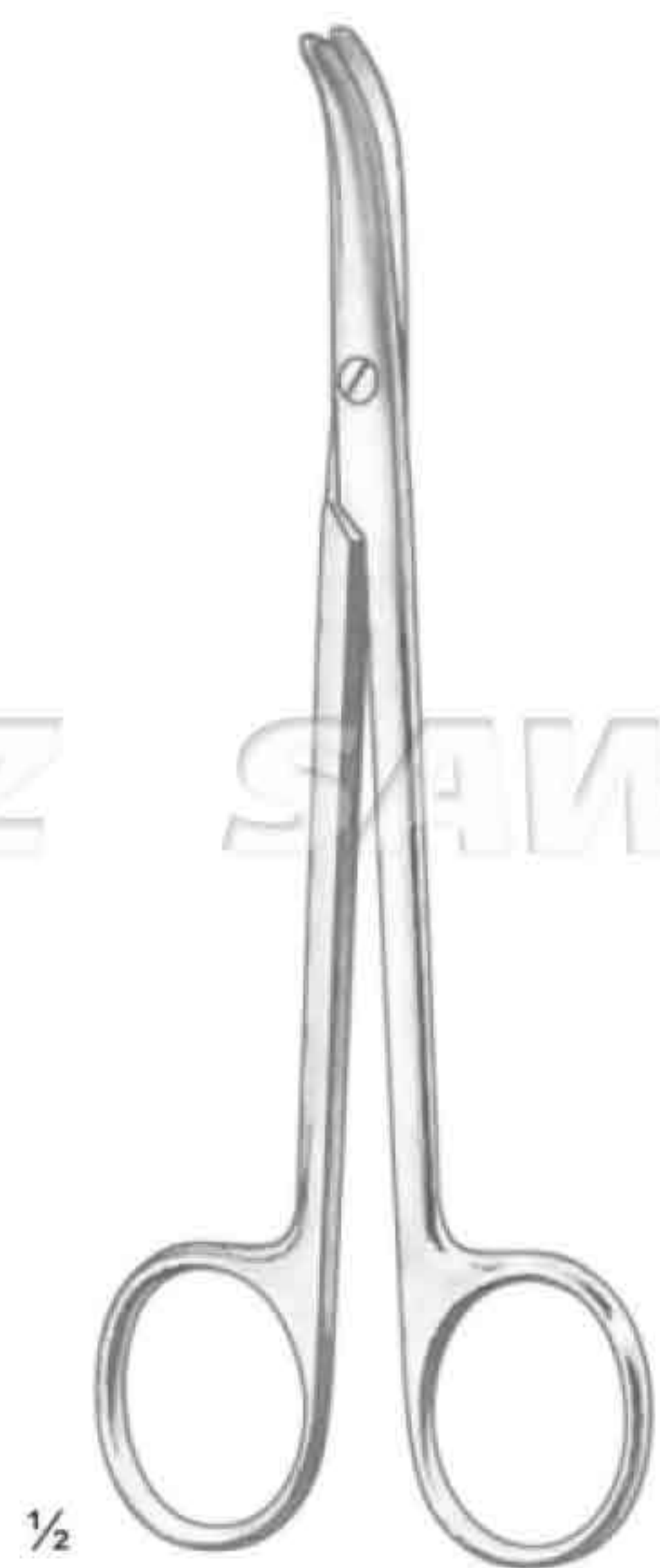
SAWEEZ SAWEEZ SAWEEZ SAWEEZ

1/2

1/4

SSC -11-12-81 18.0 cm / 7" SSC -11-12-82 20.0 cm / 8" SSC -11-12-83 23.0 cm / 9" SSC -11-12-84 25.0 cm / 10" SSC -11-12-85 28.0 cm / 11" SSC -11-12-86 30.0 cm / 12"

Metzenbaum-Nelson



Fomon

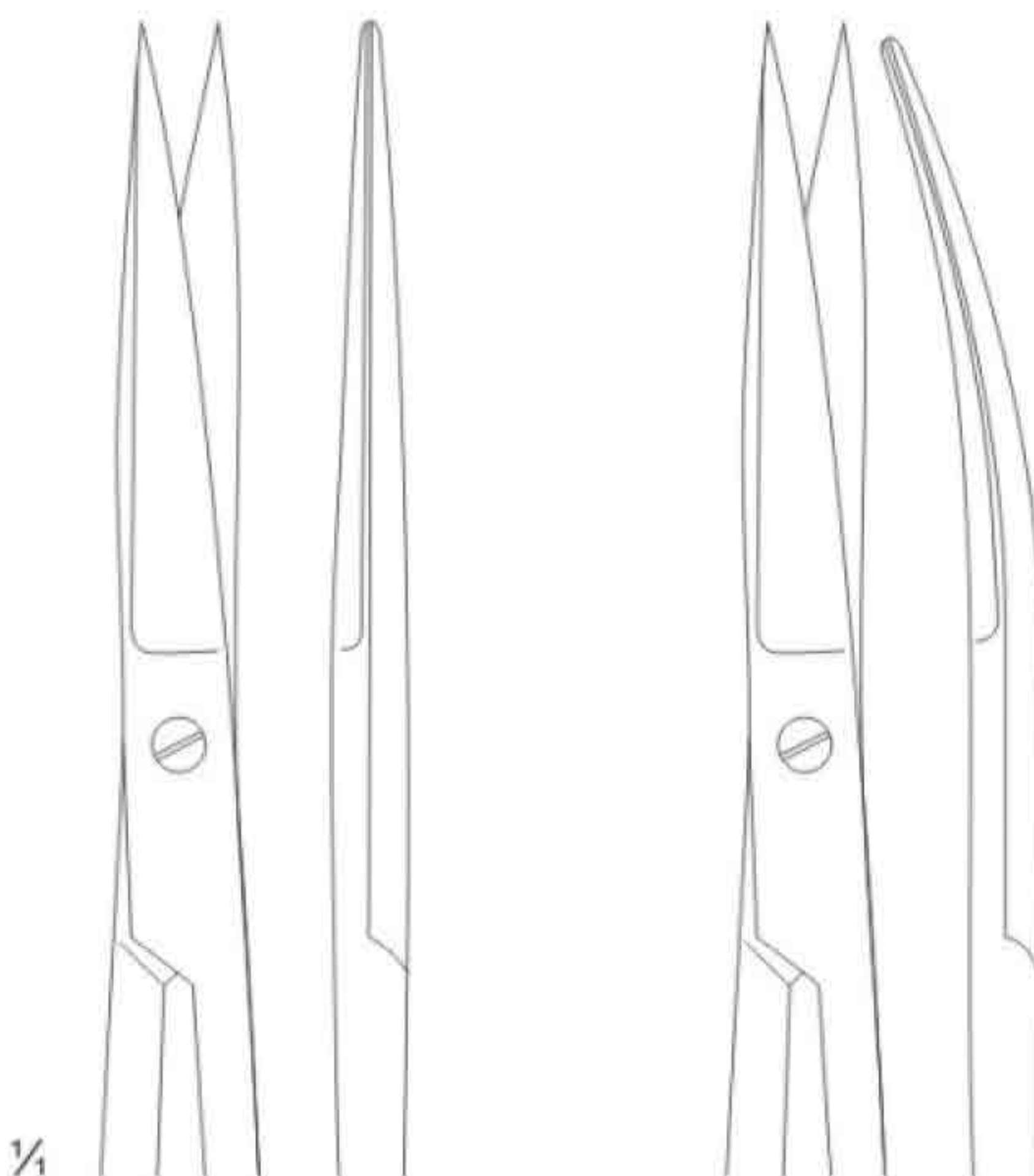


SSC-11-12-87
13.5 cm / 5 1/4"

Fine Operating Scissors



Joseph



SSC-11-12-88
14.0 cm / 5 1/2"

SSC-11-12-89
14.0 cm / 5 1/2"



blades, also for undermining

SAWEEZ SAWEEZ SAWEEZ SAWEEZ



SSC-11-12-90
12.0 cm / 4 3/4"

SSC-11-12-91
15.0 cm / 6"

Outside cutting edge

Kilner

SAWEEZ SAWEEZ SAWEEZ SAWEEZ



SSC-11-12-92
14.0 cm / 5 1/2"

SSC-11-12-93
14.0 cm / 5 1/2"

SSC-11-12-94
15.0 cm / 6"

SSC-11-12-95
18.0 cm / 7"

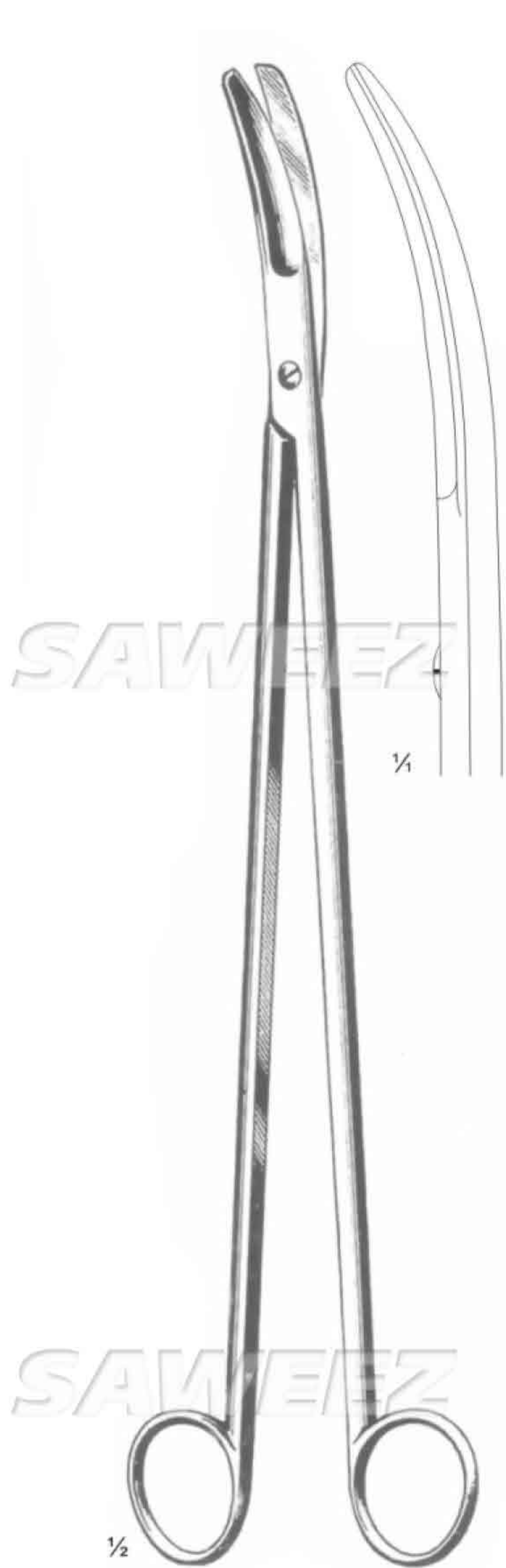
SSC-11-12-96
15.0 cm / 6"

SSC-11-12-97
18.0 cm / 7"

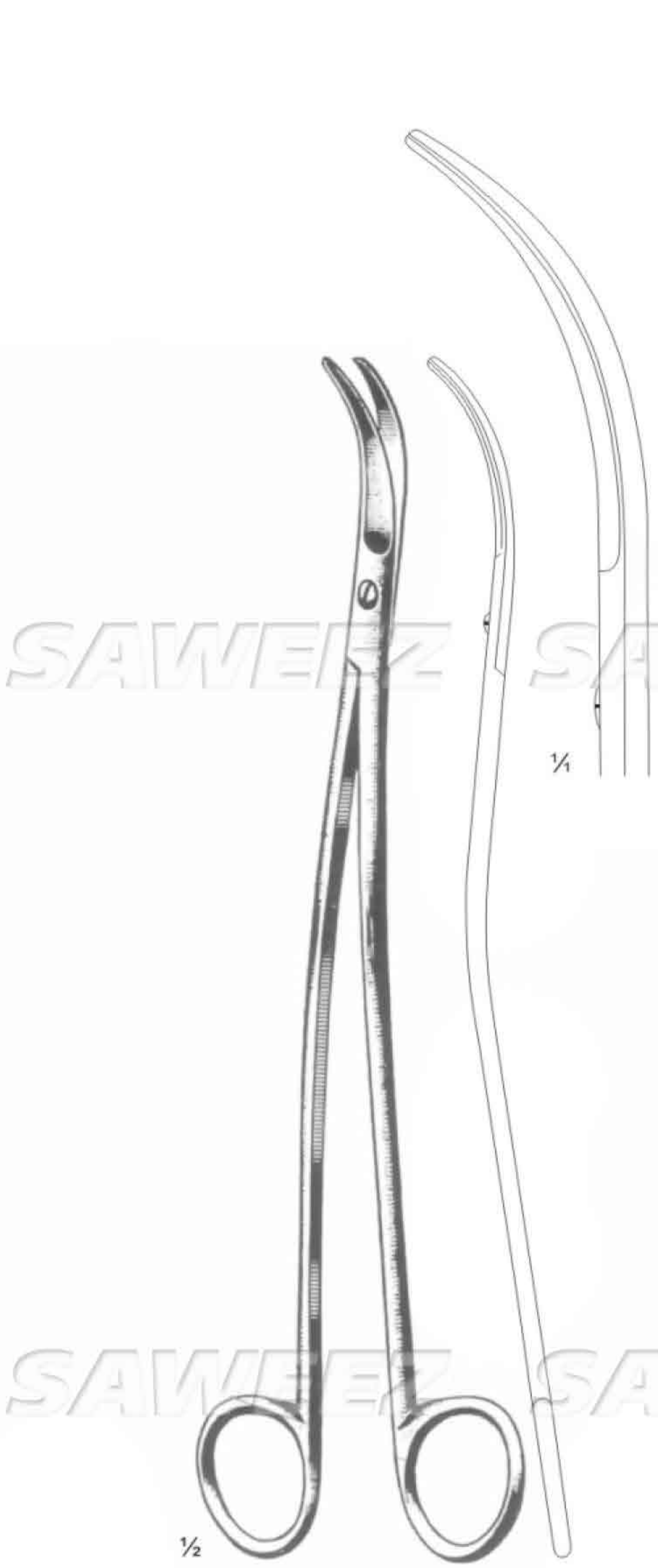
Reynolds



SAWEEZ SAWEEZ SAWEEZ SAWEEZ



Crafoord
SSC-11-12-98
30.0 cm / 12"



Satinsky
SSC-11-12-99
24.5 cm / 10"




Klinkenbergh-Loth
SSC-11-13-00
23.0 cm / 9"

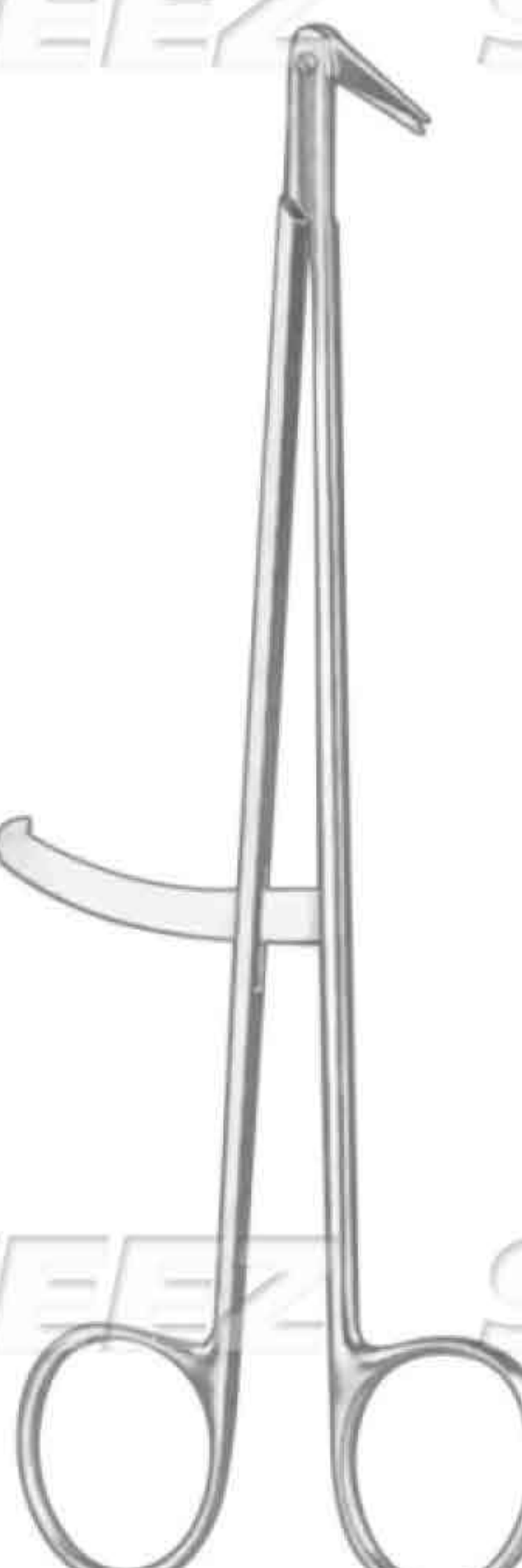
SAWEEZ SAWEEZ SAWEEZ SAWEEZ



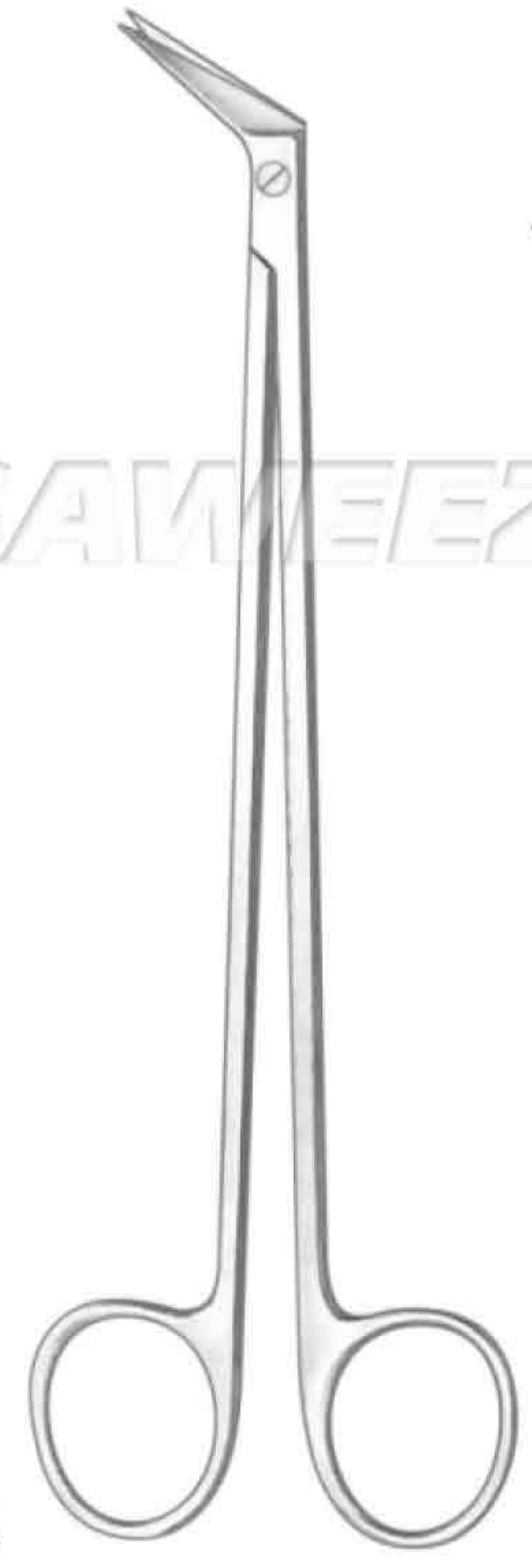
SAWEEZ SAWEEZ SAWEEZ SAWEEZ

Model	Angle	Length
SSC-11-13-01	25°	18 cm / 7"
SSC-11-13-02	45°	18 cm / 7"
SSC-11-13-03	60°	17.5 cm / 7"
SSC-11-13-04	90°	17.0 cm / 6¾"
SSC-11-13-05	125°	17.0 cm / 6¾"
SSC-11-13-06	125°	17.0 cm / 6¾"



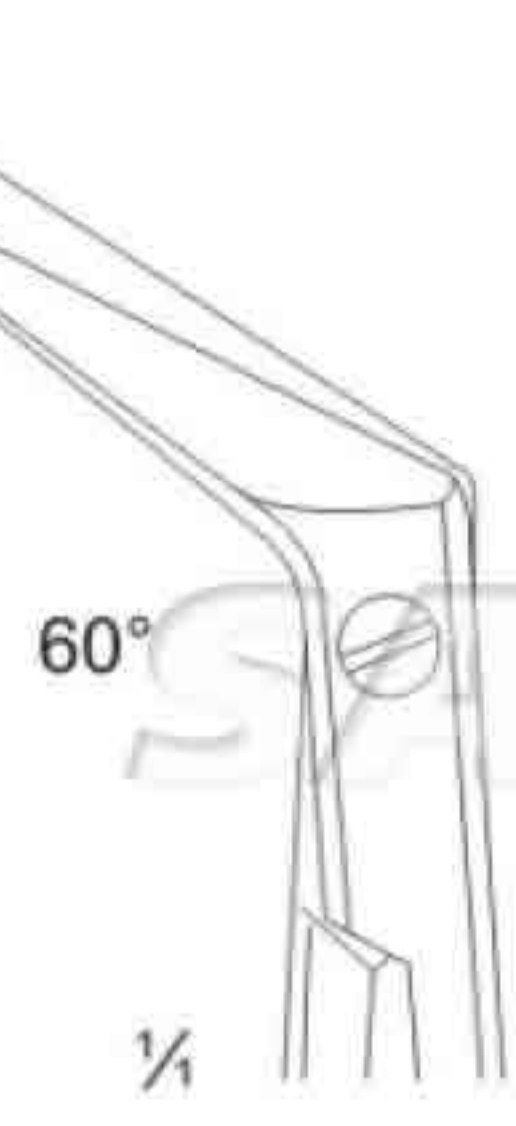


SAWEEZ SAWEEZ SAWEEZ SAWEEZ



1/2

Potts-Smith



60°

1/4

SSC-11-13-07
19.0 cm / 7 1/2"



40°

SSC-11-13-08
19.0 cm / 7 1/2"



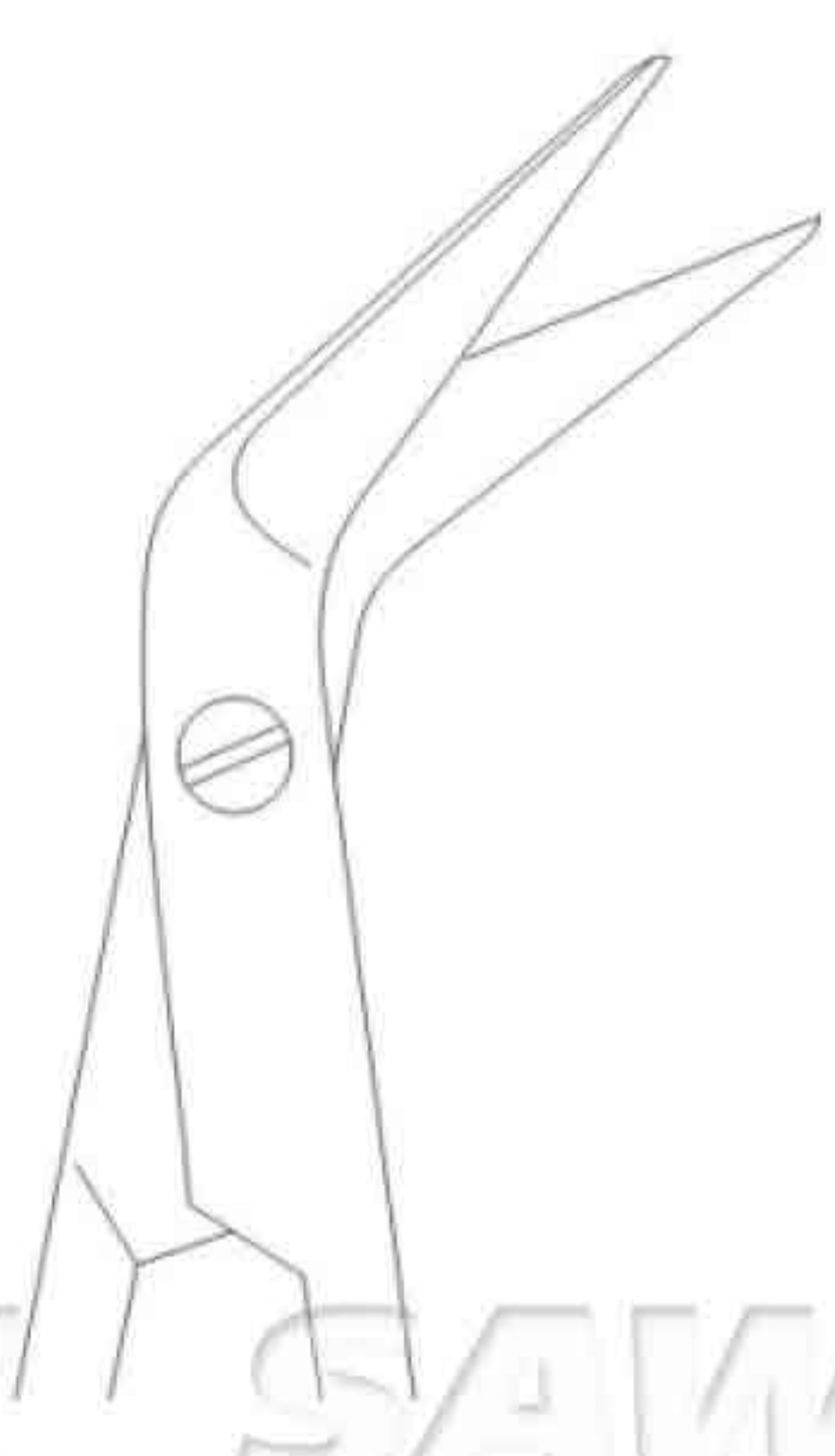
25°

SSC-11-13-09
19.0 cm / 7 1/2"



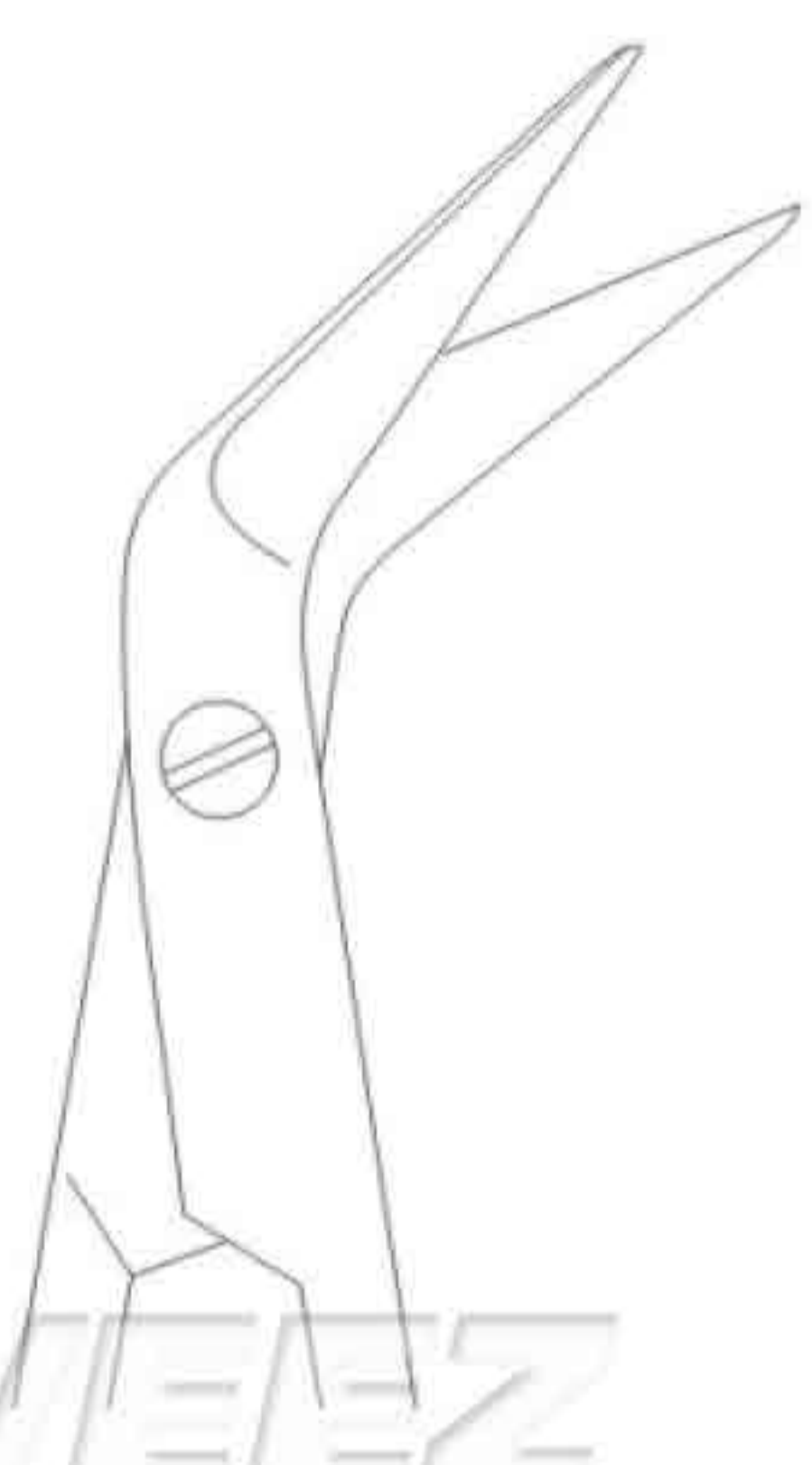
1/2

Potts de Martel



1/4

SSC-11-13-10
21.0 cm / 8 1/4"

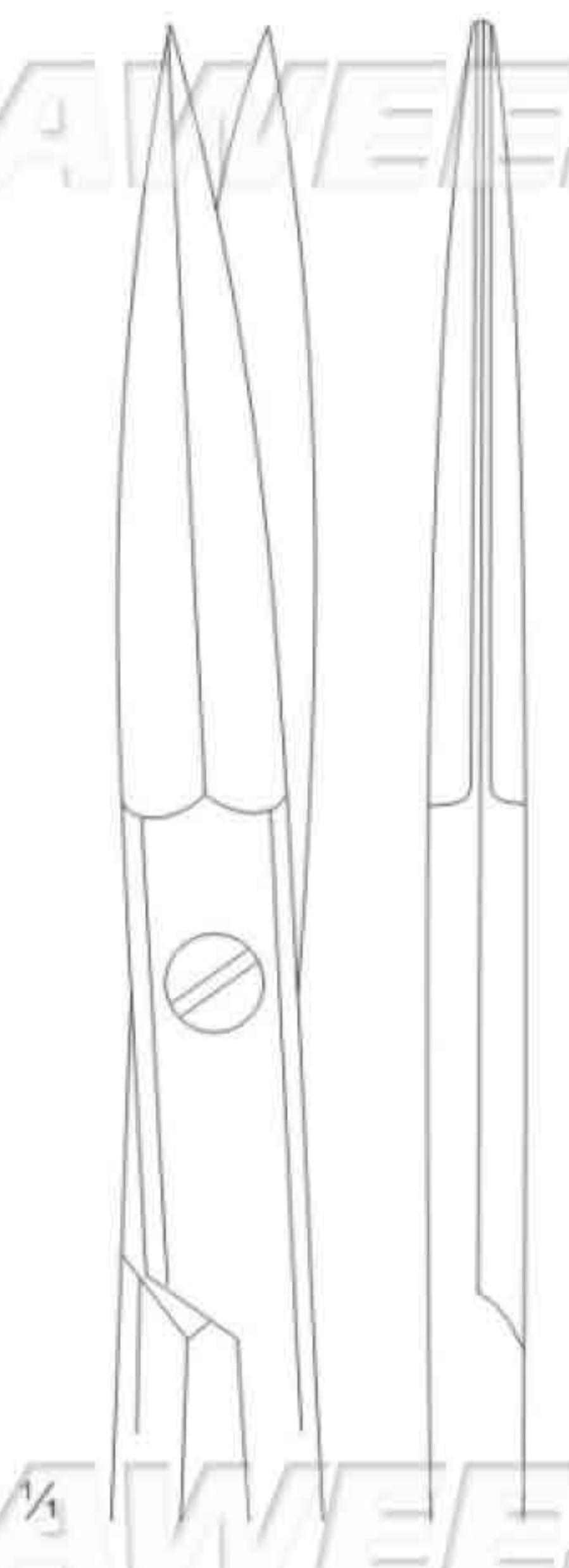


SSC-11-13-11
24.0 cm / 9 1/2"



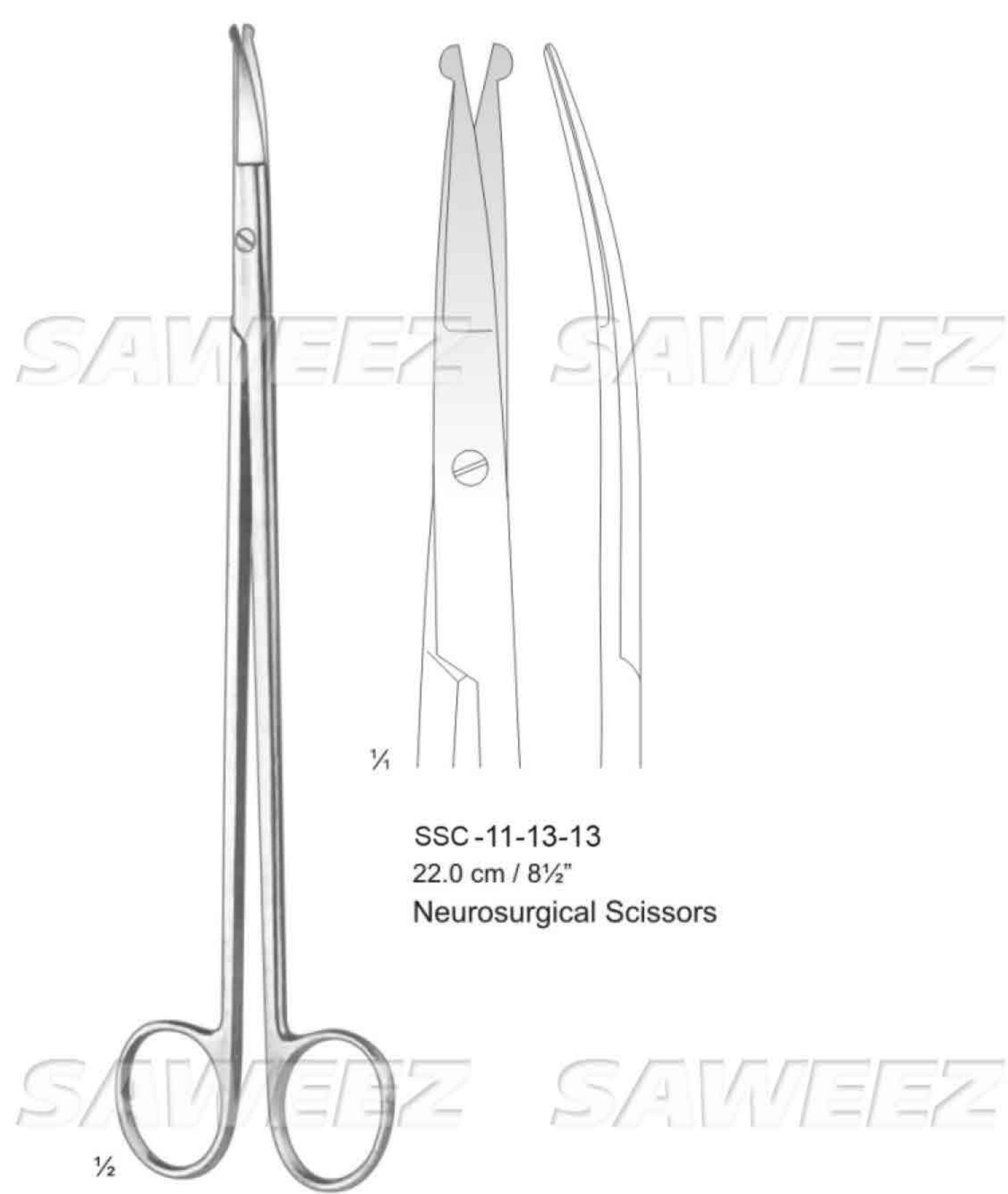
1/2

Mc Indoe



1/4

SSC-11-13-12
19.0 cm / 7 1/2"



SSC-11-13-13
22.0 cm / 8 1/2"
Neurosurgical Scissors



SSC-11-13-14
17.0 cm / 6 3/4"
Neurosurgical Scissors



SSC-11-13-15
17.0 cm / 6 3/4"
Dura Scissors



SSC-11-13-16
17.5 cm / 7"
Dissecting Scissors

Strully

Dandy

Schmieden- Taylor

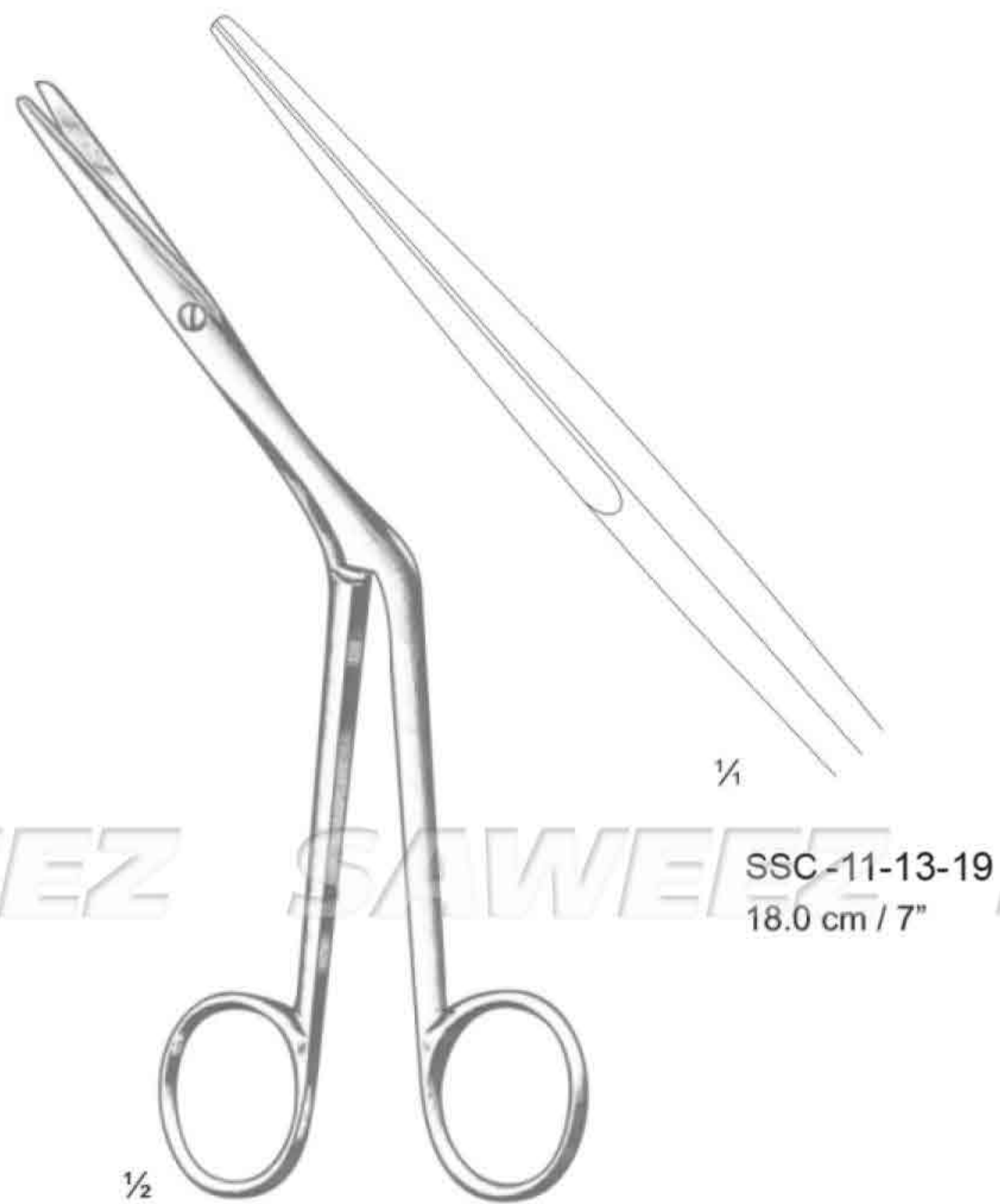
Toennis-Adson



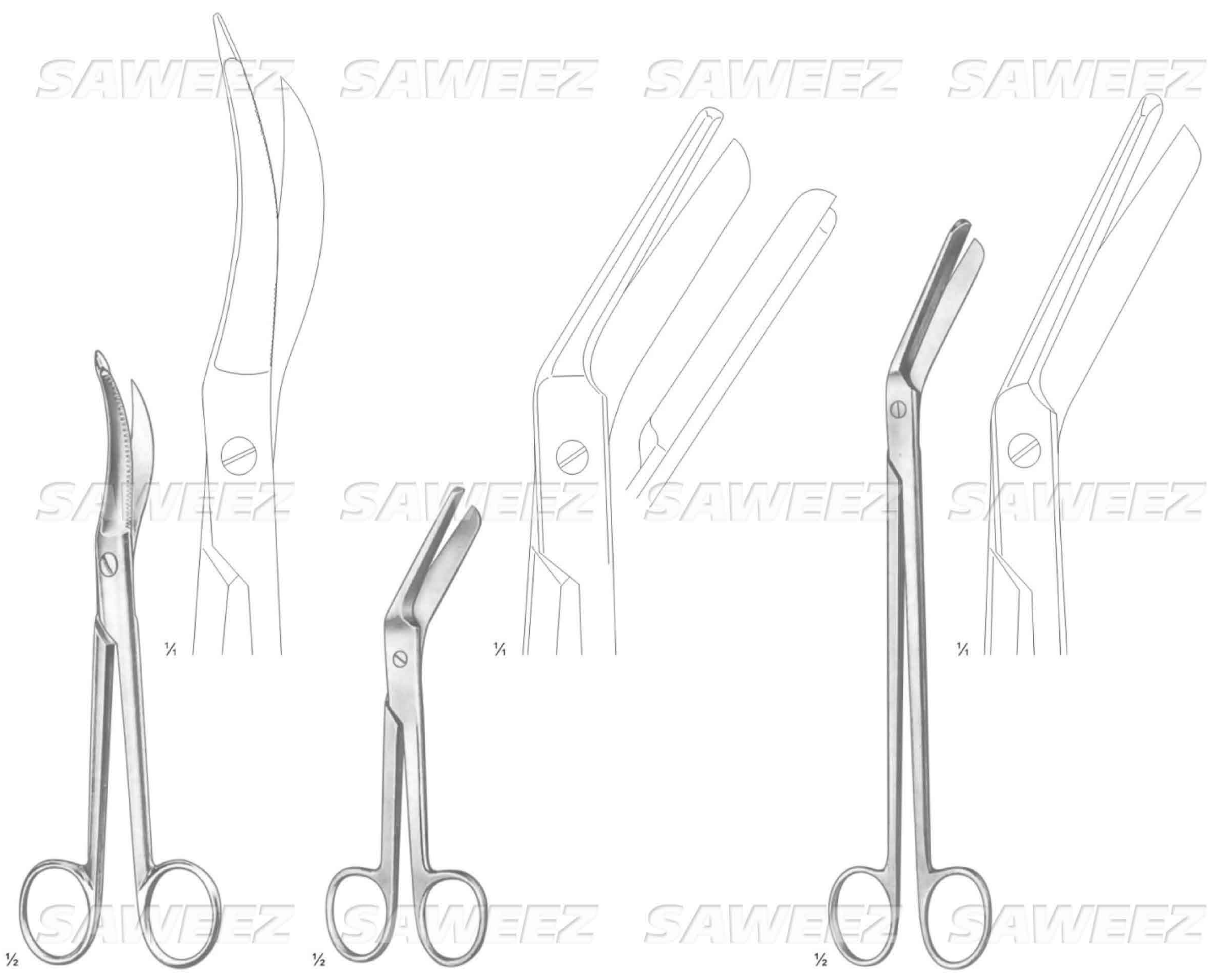
Fomon



Cottle



Heymann



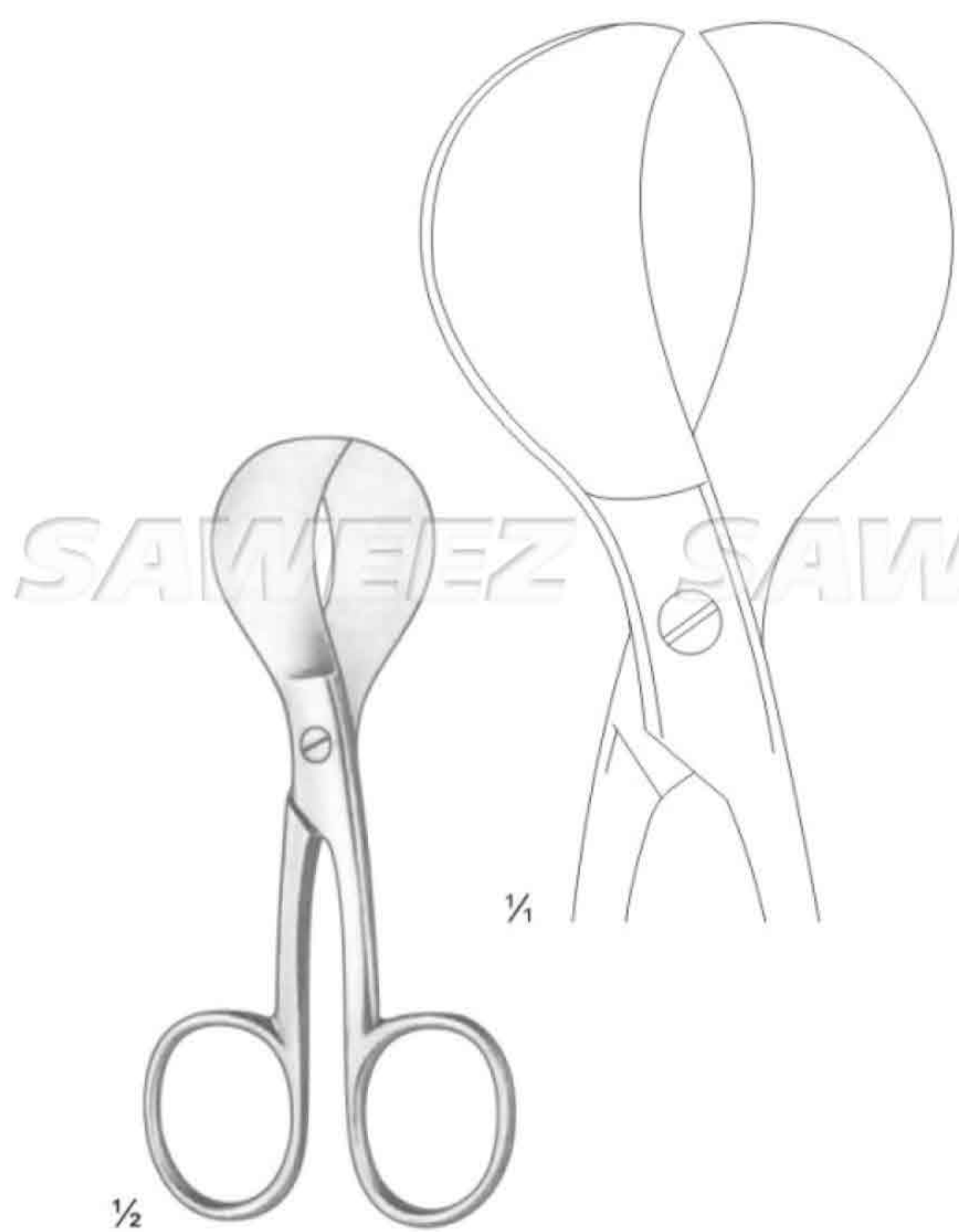
Waldmann
SSC-11-13-20
18.0 cm / 7"

Braun-Stadler
SSC-11-13-21
14.0 cm / 5½"

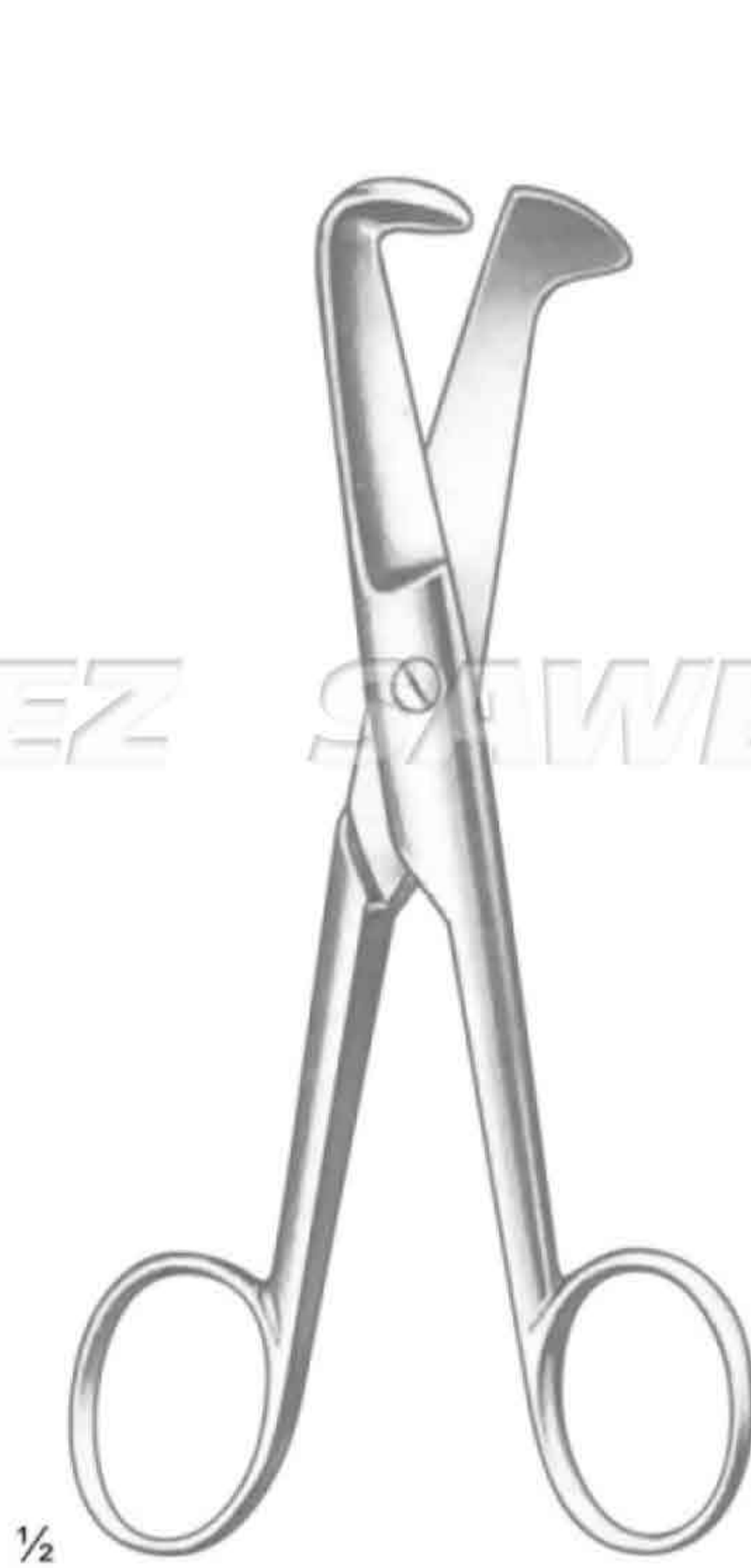
Braun-Stadler
SSC-11-13-22
22.0 cm / 8¾"



SAWEEZ SAWEEZ SAWEEZ SAWEEZ



Mod. USA
SSC-11-13-23
10.5 cm / 4 1/4"

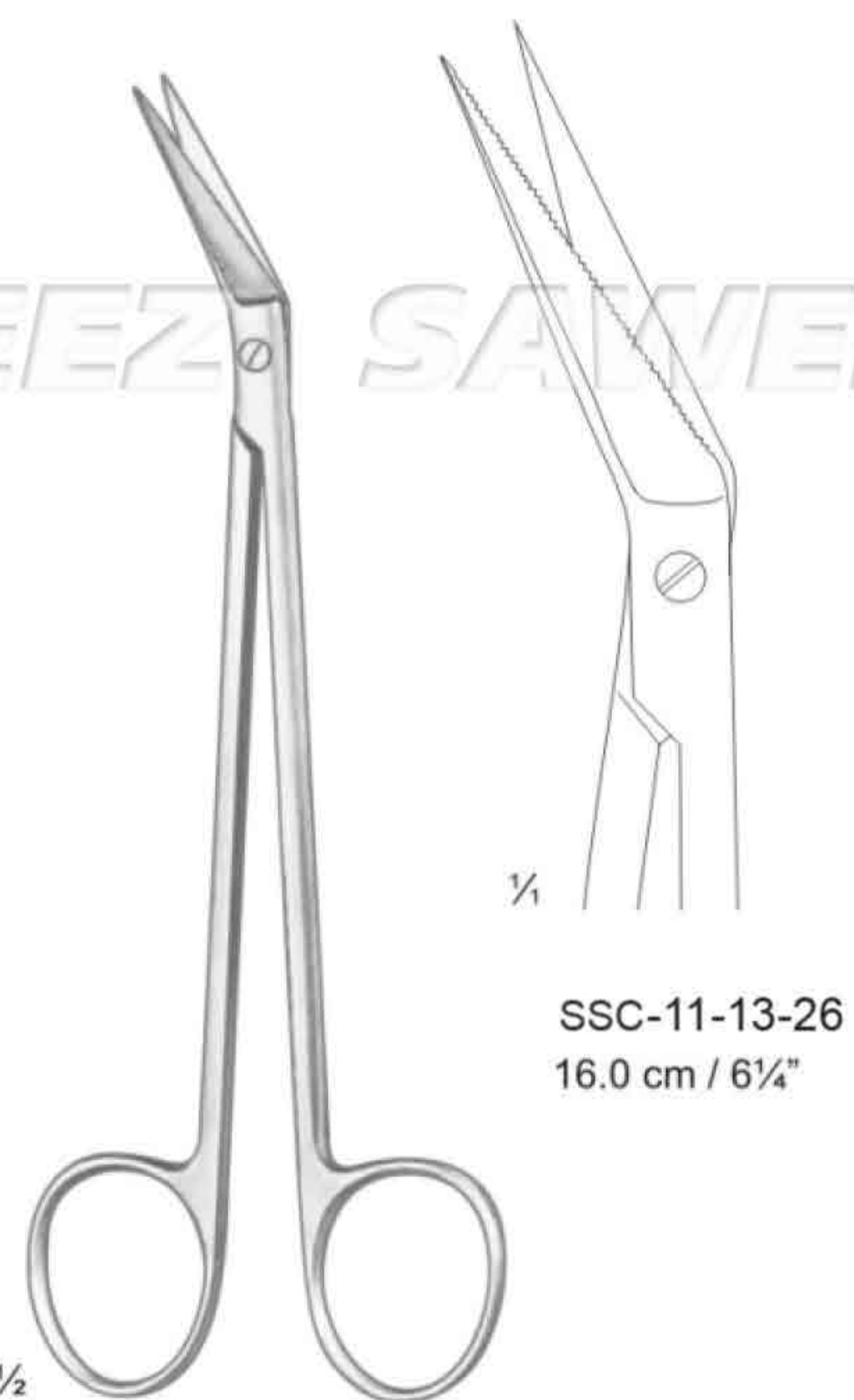


Schuhmacher
SSC-11-13-24
15.0 cm / 6"

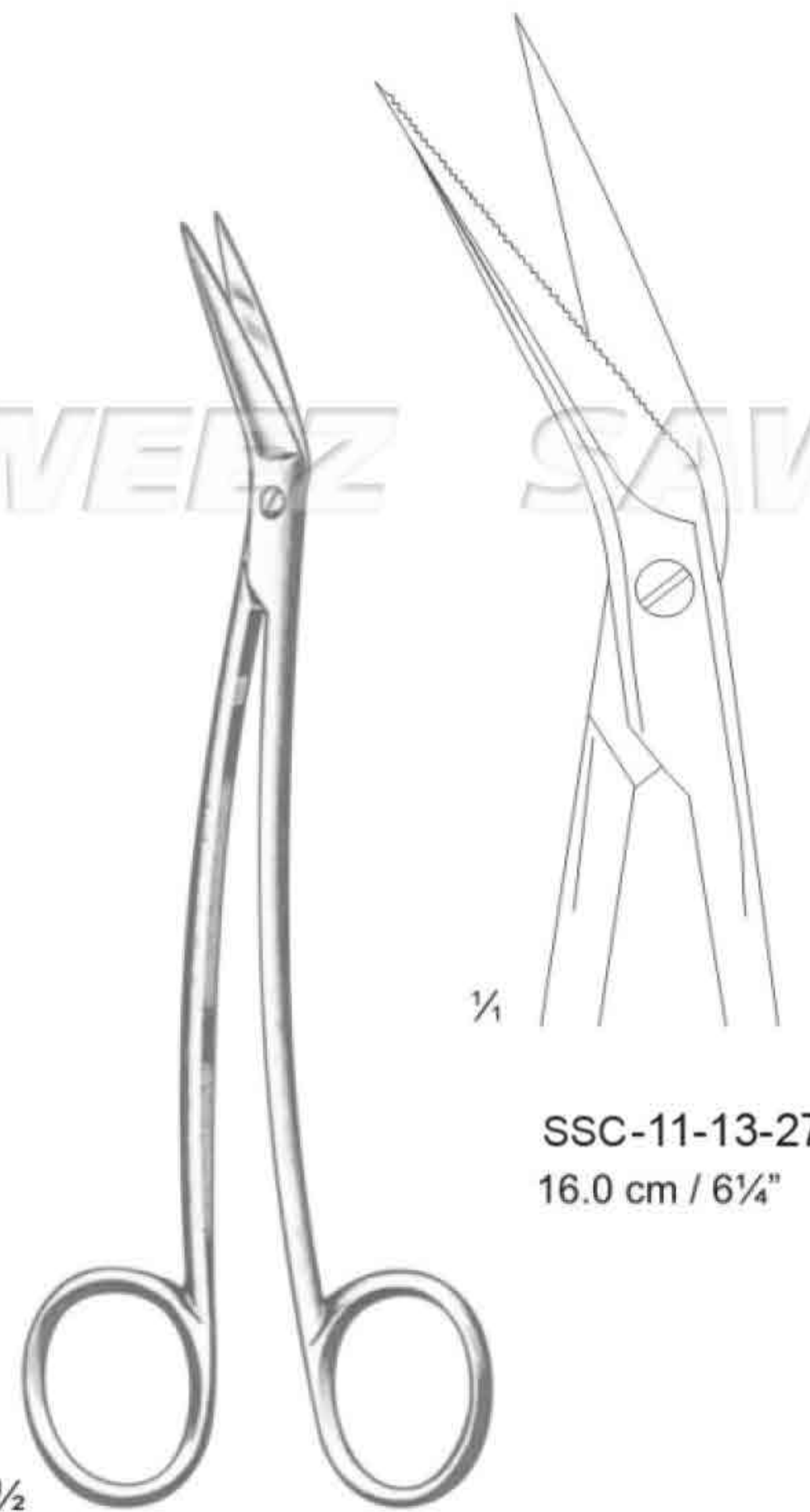


Busch
SSC-11-13-25
16.0 cm / 6 1/4"

SAWEEZ SAWEEZ SAWEEZ SAWEEZ



SSC-11-13-26
16.0 cm / 6 1/4"



SSC-11-13-27
16.0 cm / 6 1/4"

SAWEEZ SAWEEZ SAWEEZ Locklin SAWEEZ



SSC-11-13-28
12.5 cm / 5"

Quinby



SSC-11-13-29
12.0 cm / 4 3/4"

Neumann

SAWEEZ SAWEEZ SAWEEZ SAWEEZ

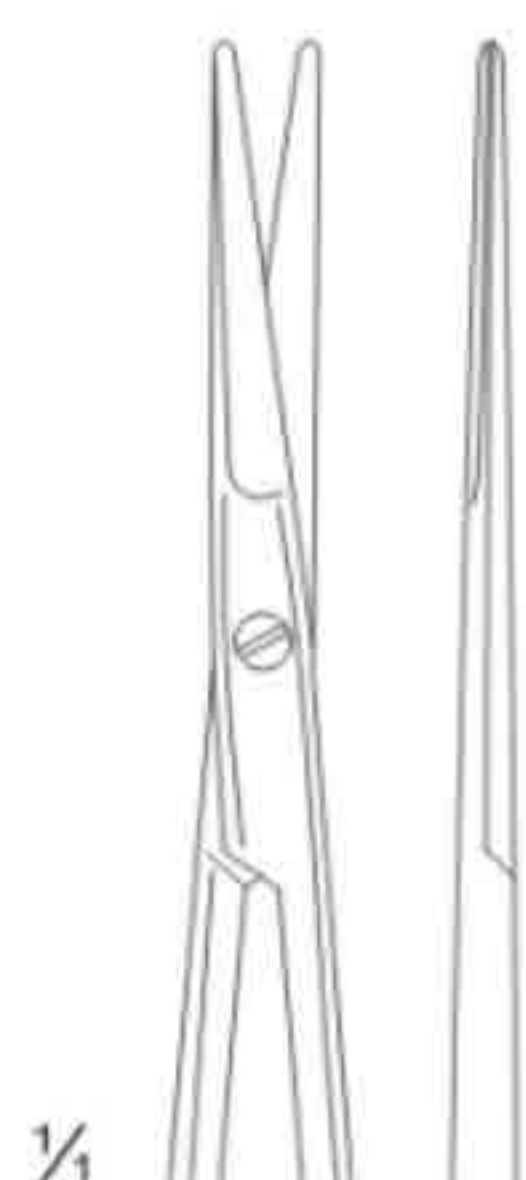


SAWEEZ

SAWEEZ

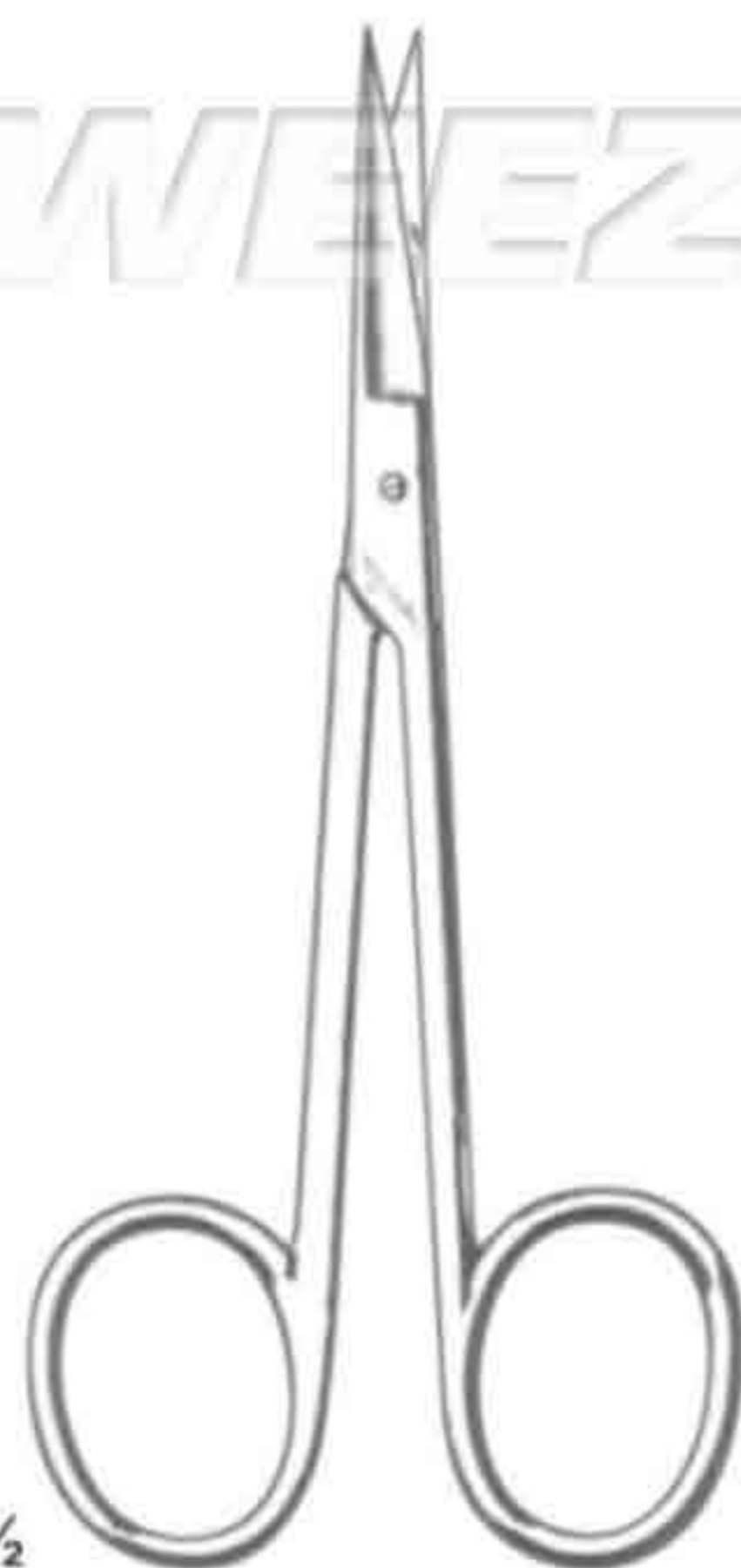
SAWEEZ

SAWEEZ



1/4

SSC -11-13-30
9.0 cm / 3 1/2"

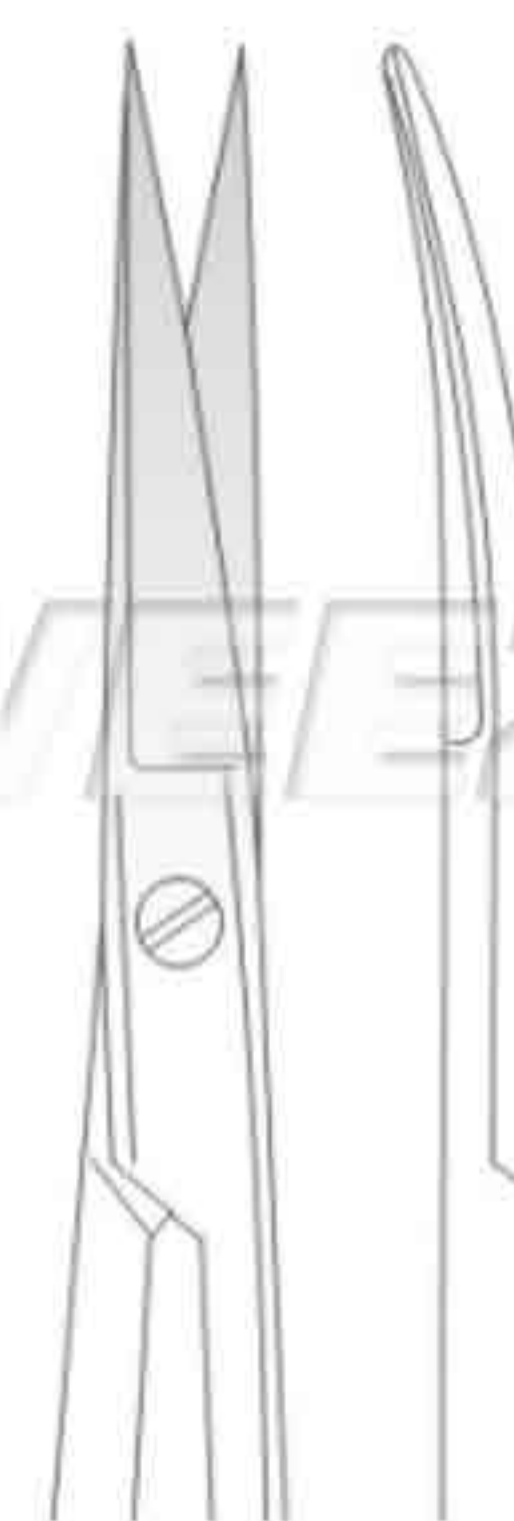


1/2

1/4



SSC -11-13-31
11.5 cm / 4 1/2"



SSC -11-13-32
11.5 cm / 4 1/2"



SSC -11-13-33
11.5 cm / 4 1/2"



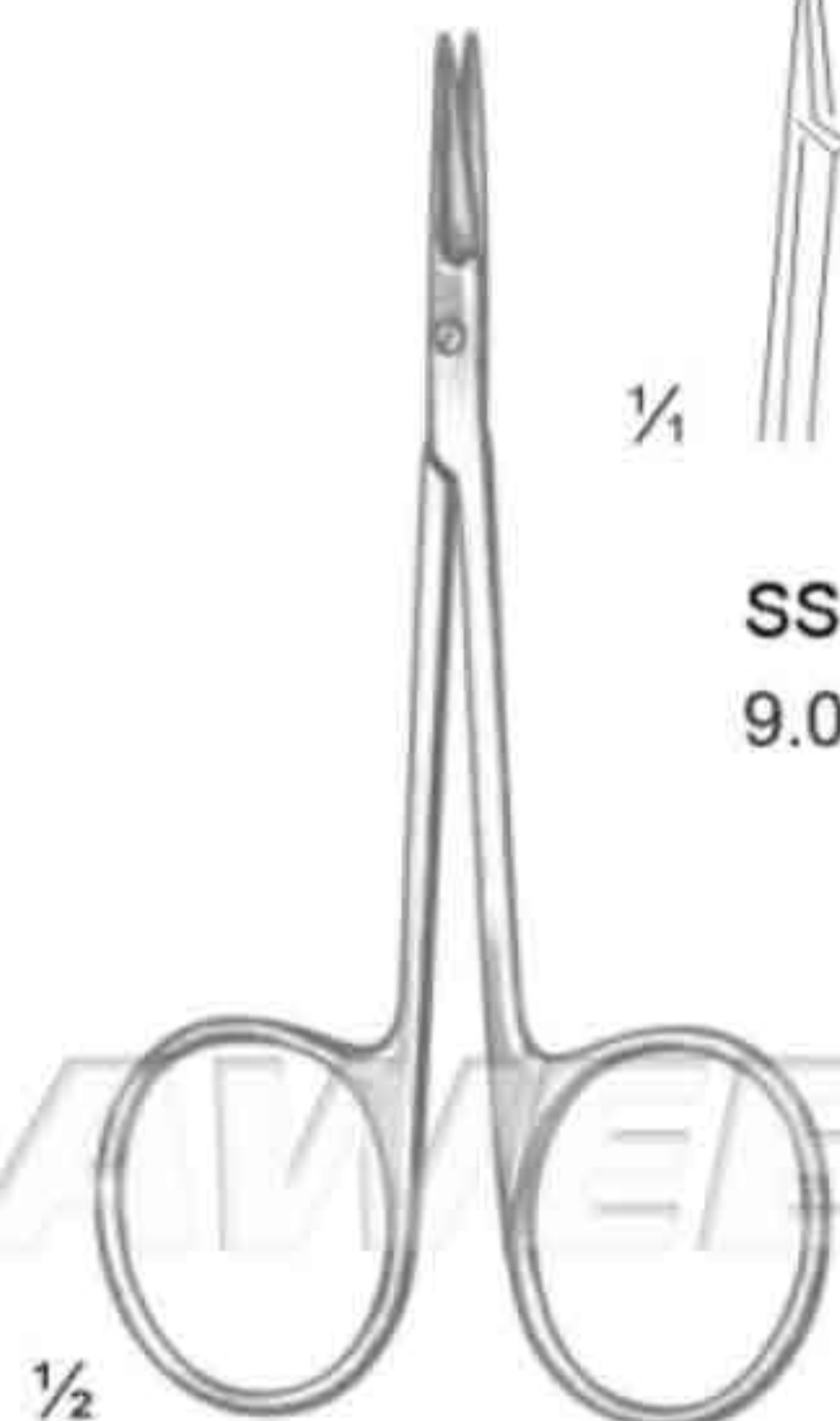
SSC -11-13-34
11.5 cm / 4 1/2"

SAWEEZ

SAWEEZ

SAWEEZ

SAWEEZ

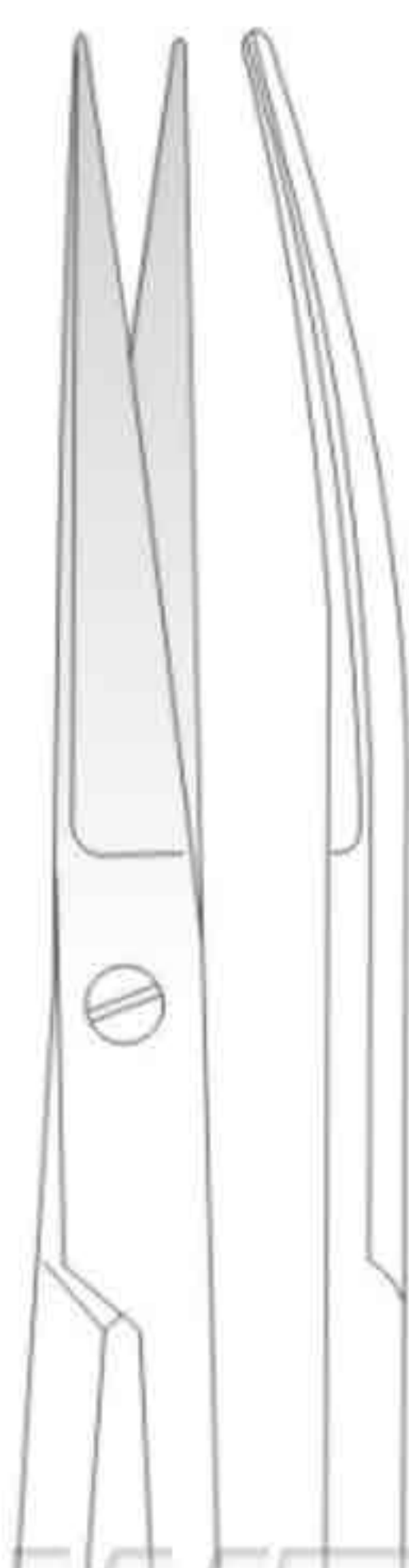


1/2



1/4

SSC -11-13-35
12.0 cm / 4 3/4"



SSC -11-13-36
12.0 cm / 4 3/4"



SAWEEZ

SAWEEZ

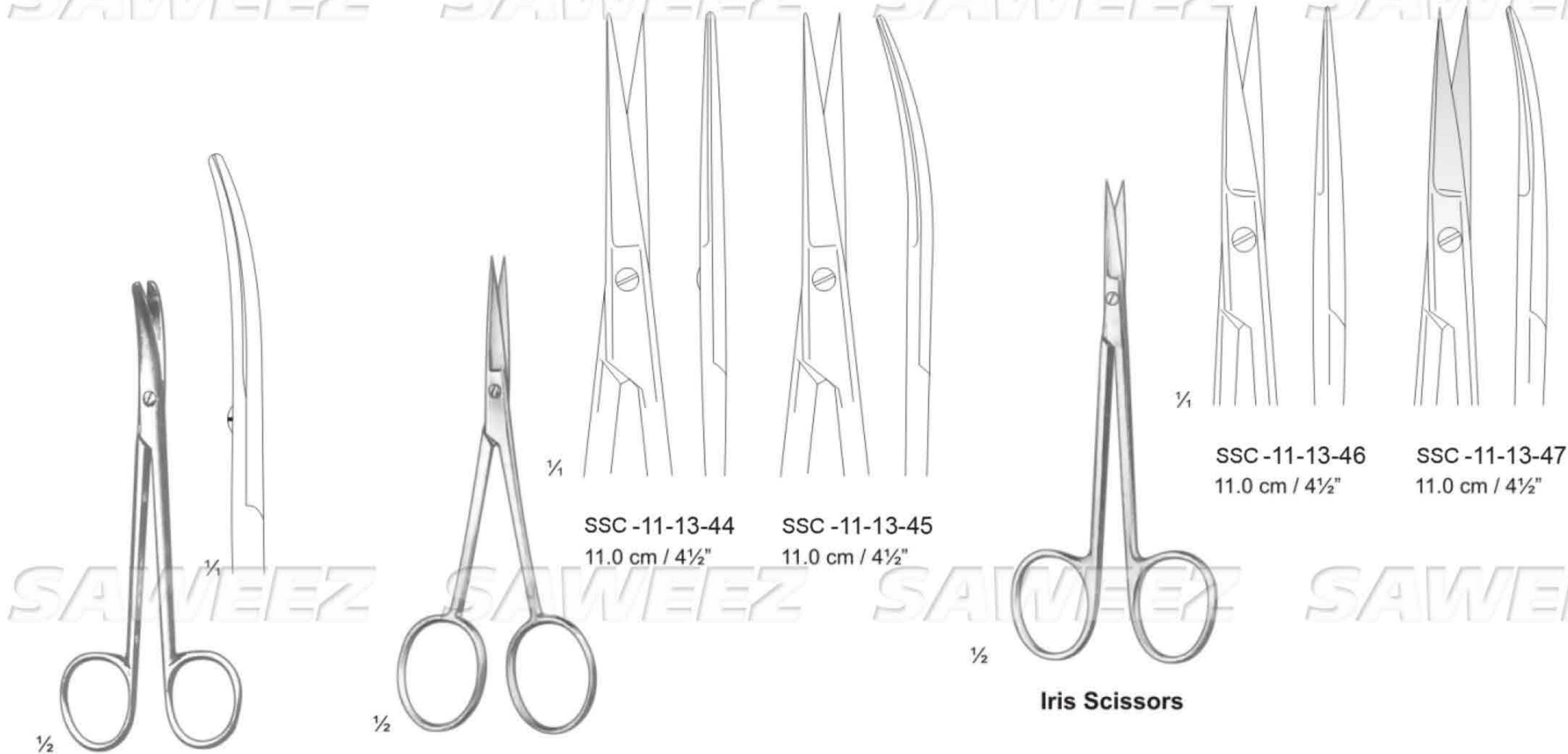
SAWEEZ

SAWEEZ



Tenotomy Scissors

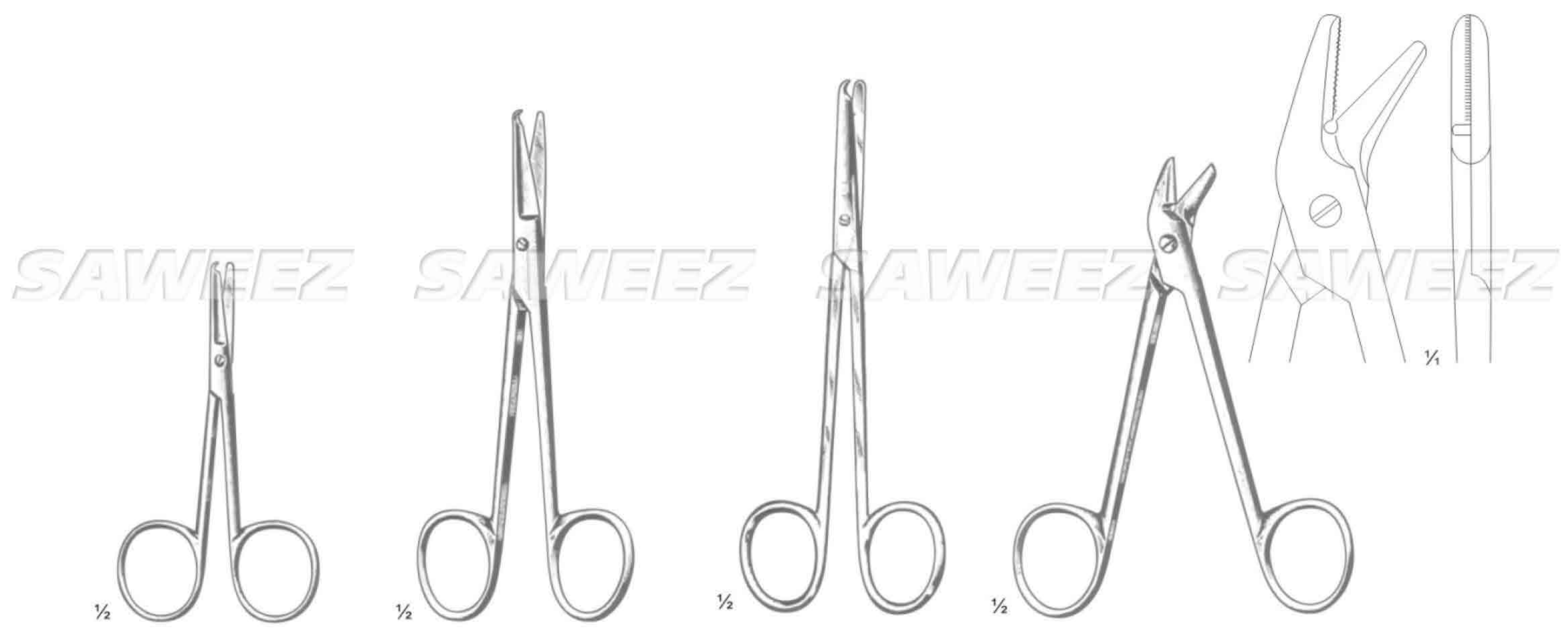
Strabismus Scissors



Enucleation Scissors
SSC-11-13-43
11.0 cm / 4 1/2"

Dissecting Scissors
(Post Mortem)

Iris Scissors

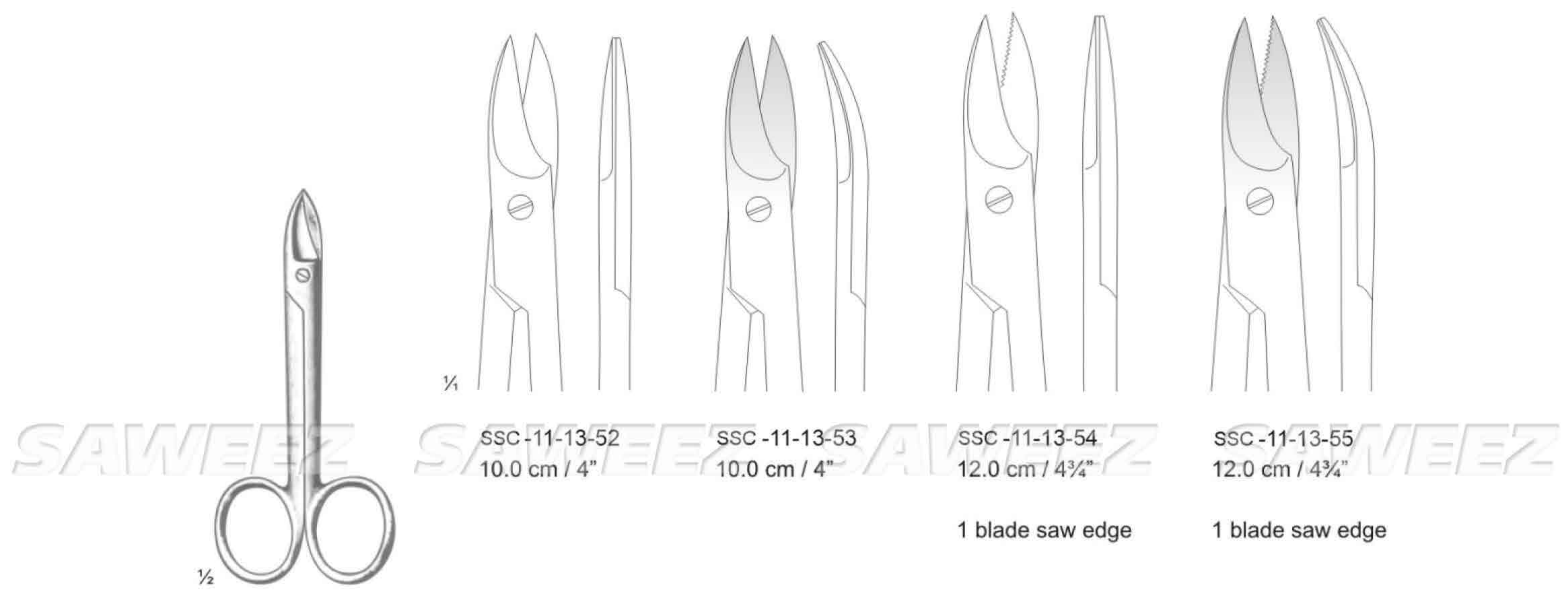


Spencer
SSC-11-13-48
9.0 cm / 3½"

Spencer
SSC-11-13-49
13.0 cm / 5"

Littauer
SSC-11-13-50
14.0 cm / 5½"

Universal
SSC-11-13-51
12.0 cm / 4¾"



SSC-11-13-52
10.0 cm / 4"

SSC-11-13-53
10.0 cm / 4"

SSC-11-13-54
12.0 cm / 4¾"

SSC-11-13-55
12.0 cm / 4¾"

1 blade saw edge

1 blade saw edge



1/4

SSC-11-13-56	SSC-11-13-57	SSC-11-13-58	SSC-11-13-59	SSC-11-13-60	SSC-11-13-61	SSC-11-13-62	SSC-11-13-63	SSC-11-13-64
10.5 cm / 4 1/4"	11.5 cm / 4 1/2"	13.0 cm / 5"	14.0 cm / 5 1/2"	16.0 cm / 6 1/4"	18.0 cm / 7"	20.0 cm / 8"	25.0 cm / 10"	30.0 cm / 12"

1/2

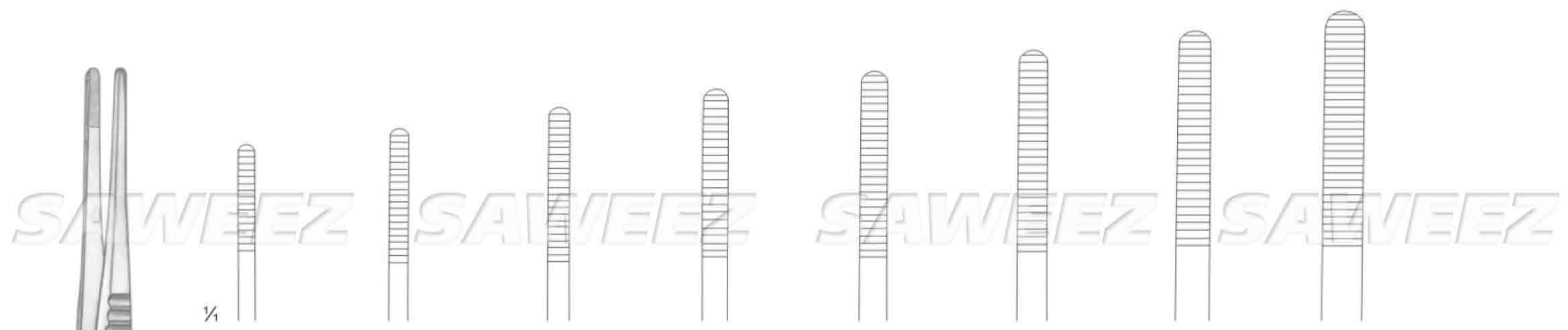
Standard

1/4

SSC-11-13-65	SSC-11-13-66	SSC-11-13-67	SSC-11-13-68	SSC-11-13-69	SSC-11-13-70	SSC-11-13-71	SSC-11-13-72
11.0 cm / 4 1/4"	13.0 cm / 5"	14.0 cm / 5 1/2"	16.0 cm / 6 1/4"	18.0 cm / 7"	20.0 cm / 8"	25.0 cm / 10"	30.0 cm / 12"

1/2

Standard Narrow



SSC-11-13-73	SSC-11-13-74	SSC-11-13-75	SSC-11-13-76	SSC-11-13-77	SSC-11-13-78	SSC-11-13-79	SSC-11-13-80
12.0 cm / 4¾"	13.0 cm / 5"	14.0 cm / 5½"	15.0 cm / 6"	18.0 cm / 7"	21.0 cm / 8¼"	25.0 cm / 10"	31.0 cm / 12¼"



Standard



SSC-11-13-81	SSC-11-13-82	SSC-11-13-83	SSC-11-13-84
12.0 cm / 4¾"	13.0 cm / 5"	14.0 cm / 5½"	15.0 cm / 6"

SSC-11-13-85	SSC-11-13-86
12.0 cm / 4¾"	15.0 cm / 6"

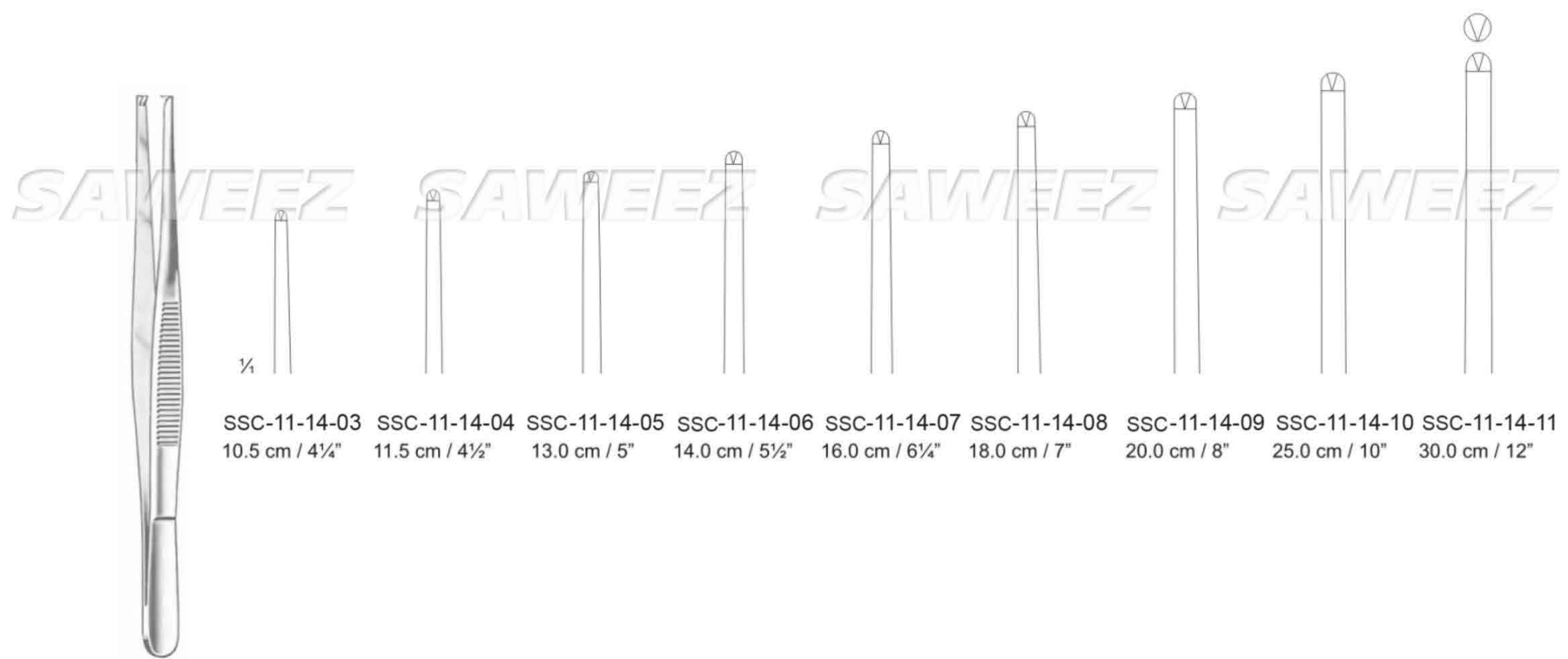
SSC-11-13-87
15.0 cm / 6"

Standard Narrow

Adson

McIndoe





- SSC-11-14-03
10.5 cm / 4 1/4"
- SSC-11-14-04
11.5 cm / 4 1/2"
- SSC-11-14-05
13.0 cm / 5"
- SSC-11-14-06
14.0 cm / 5 1/2"
- SSC-11-14-07
16.0 cm / 6 1/4"
- SSC-11-14-08
18.0 cm / 7"
- SSC-11-14-09
20.0 cm / 8"
- SSC-11-14-10
25.0 cm / 10"
- SSC-11-14-11
30.0 cm / 12"

1x2 Teeth



- SSC-11-14-12
11.5 cm / 4 1/4"
- SSC-11-14-13
13.0 cm / 5"
- SSC-11-14-14
14.0 cm / 5 1/2"
- SSC-11-14-15
16.0 cm / 6 1/4"
- SSC-11-14-16
18.0 cm / 7"
- SSC-11-14-17
20.0 cm / 8"
- SSC-11-14-18
25.0 cm / 10"

2x3 Teeth



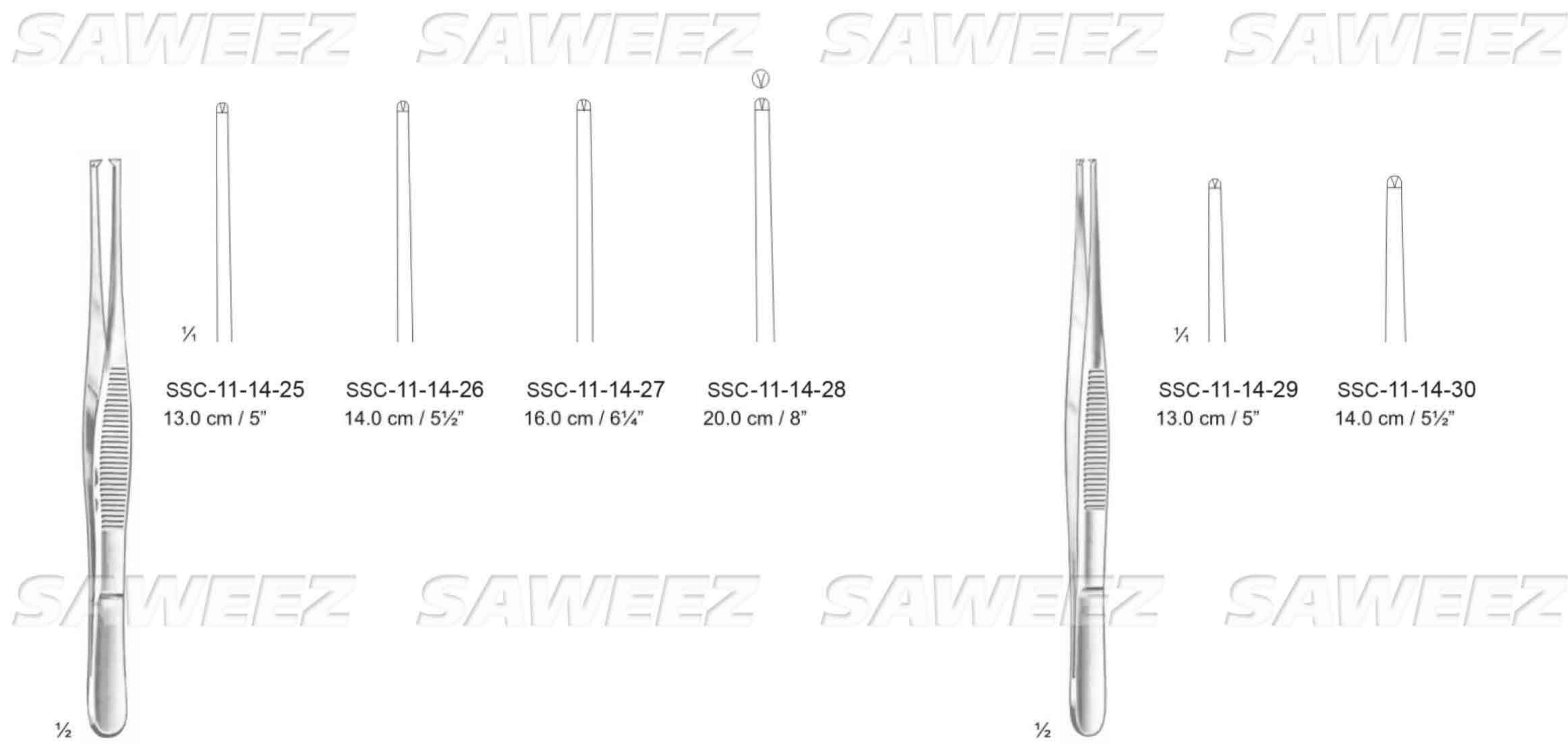
SSC-11-14-19	SSC-11-14-20	SSC-11-14-21
13.0 cm / 5"	14.0 cm / 5½"	16.0 cm / 6¼"

3x4 Teeth



SSC-11-14-22	SSC-11-14-23	SSC-11-14-24
13.0 cm / 5"	14.0 cm / 5½"	15.0 cm / 5¼"

4x5 Teeth

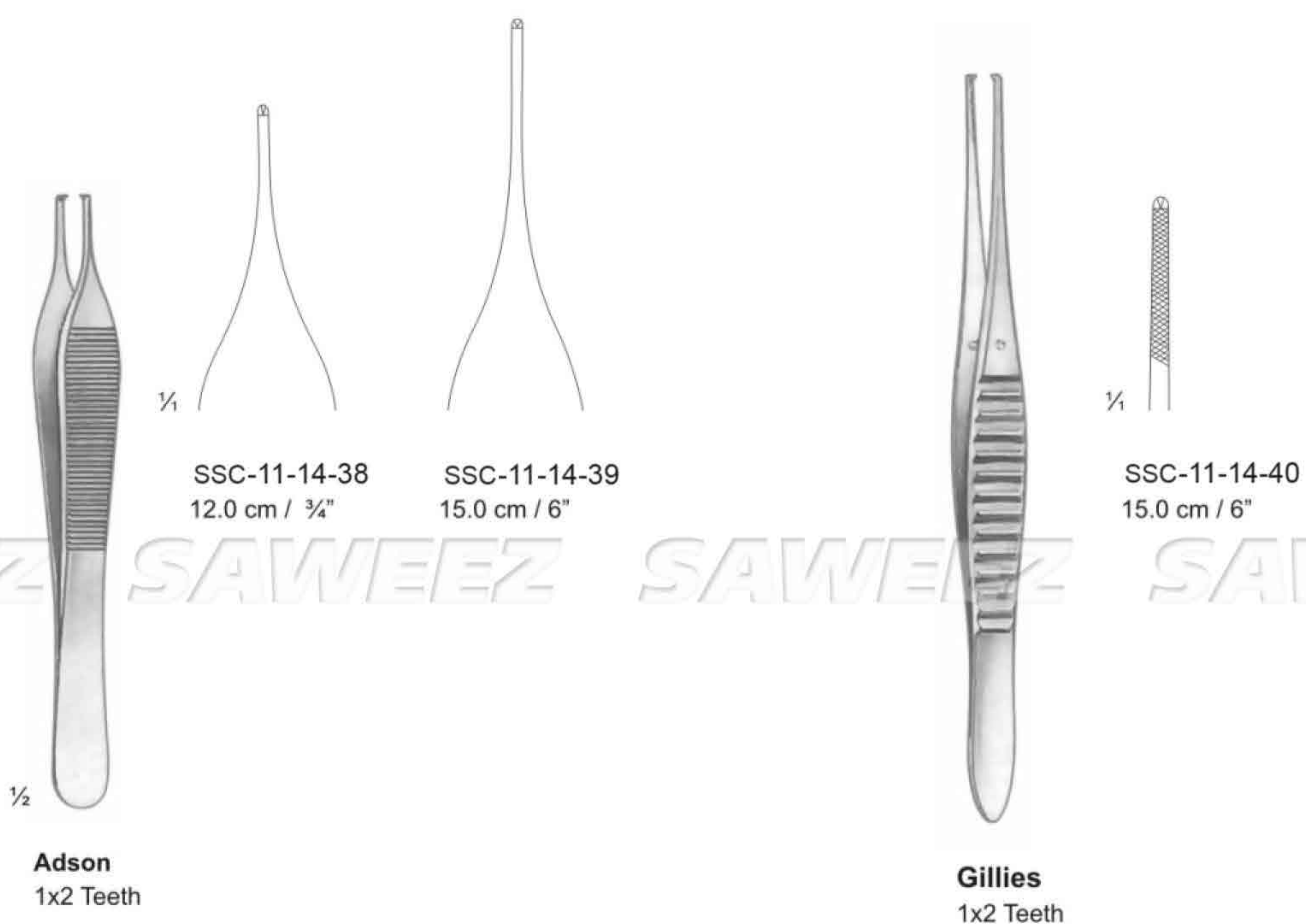
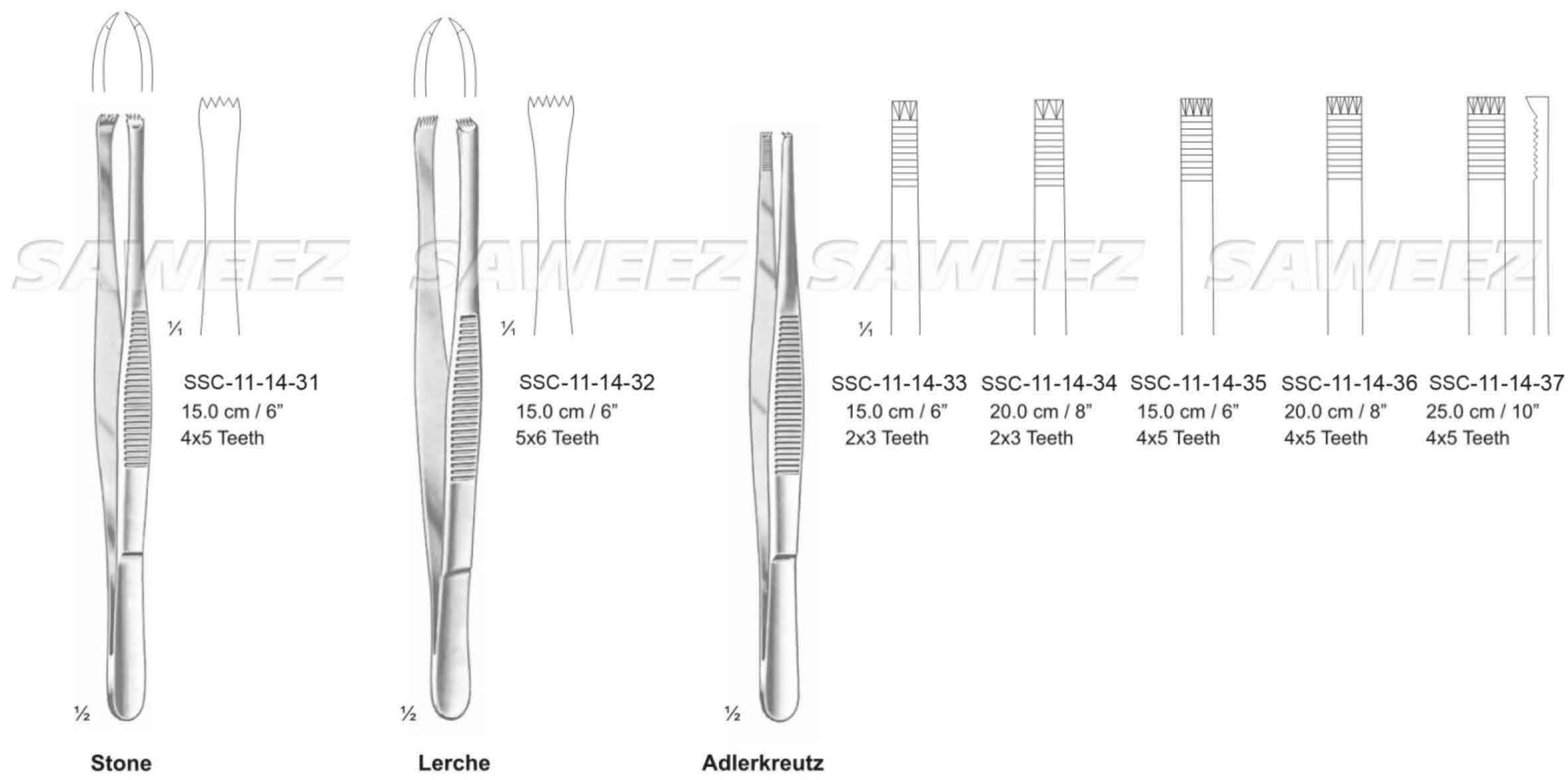


SSC-11-14-25	SSC-11-14-26	SSC-11-14-27	SSC-11-14-28
13.0 cm / 5"	14.0 cm / 5½"	16.0 cm / 6¼"	20.0 cm / 8"

SSC-11-14-29	SSC-11-14-30
13.0 cm / 5"	14.0 cm / 5½"

1x2 Teeth

1x2 Teeth





Semken
1x2 Teeth

Taylor

Taylor

Taylor



15.0 cm / 6"

Gerald

Cushing

Potts-Smith



Brophy



Adson-Brown



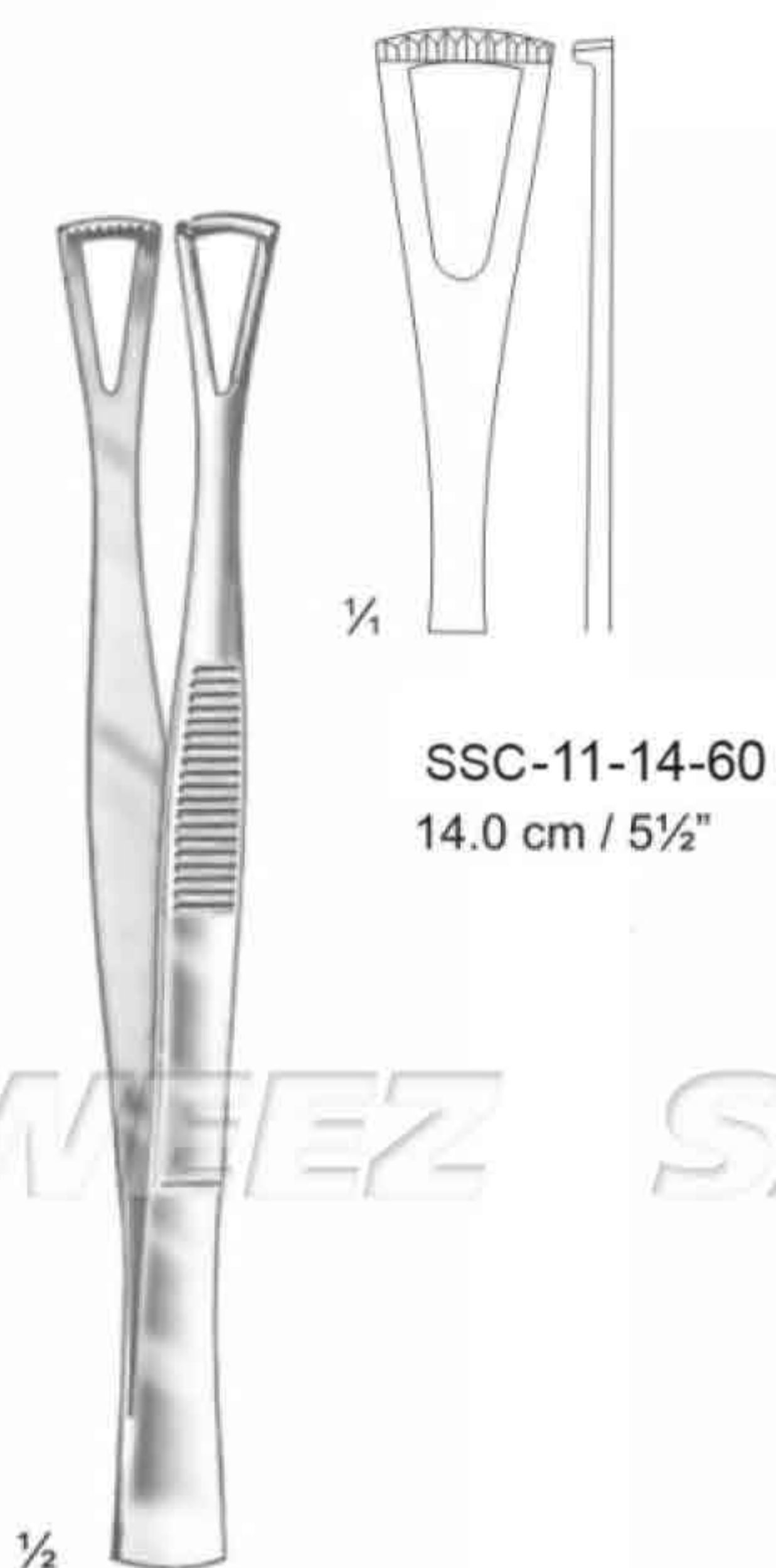
Micro-Adson



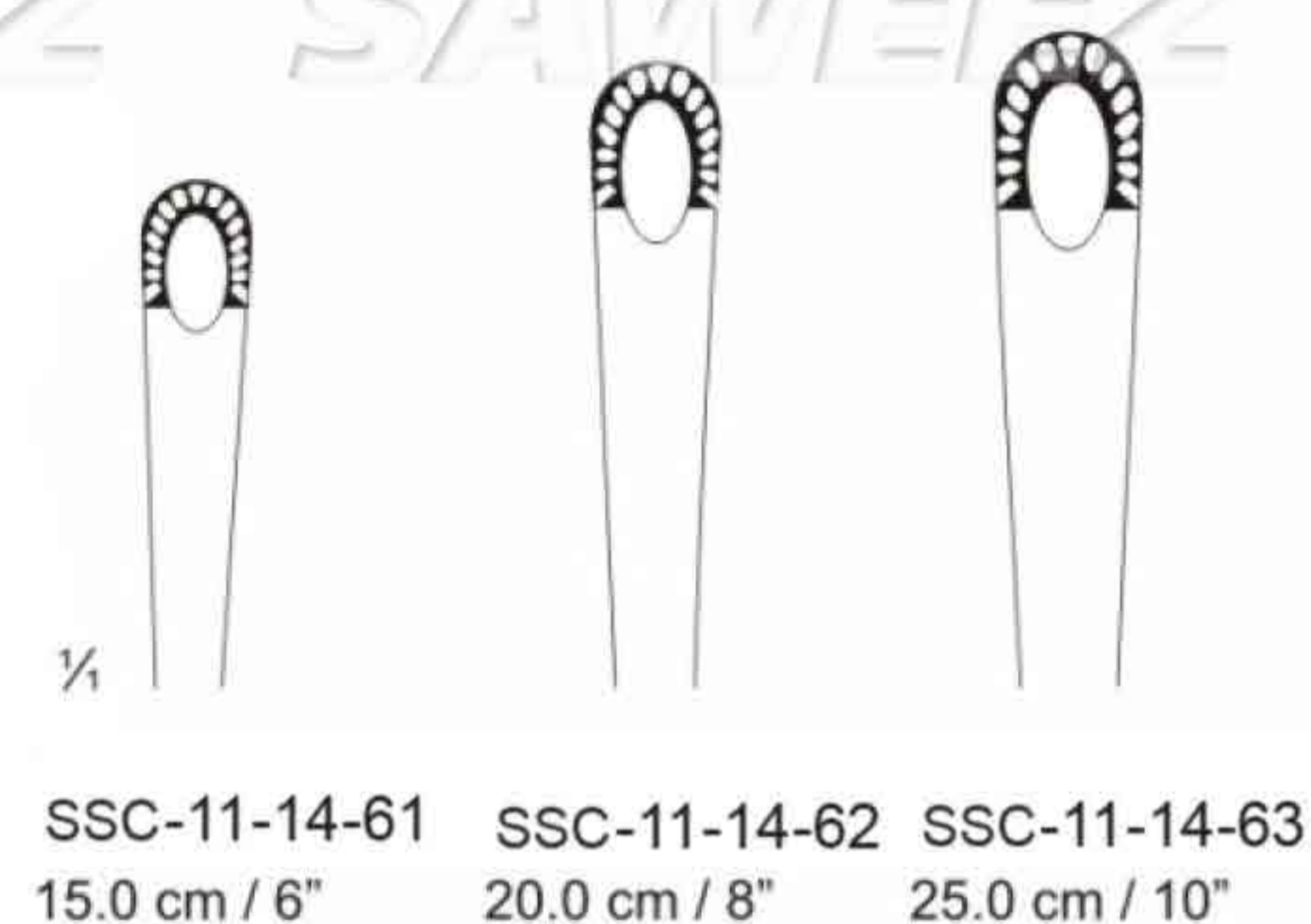
Micro-Adson



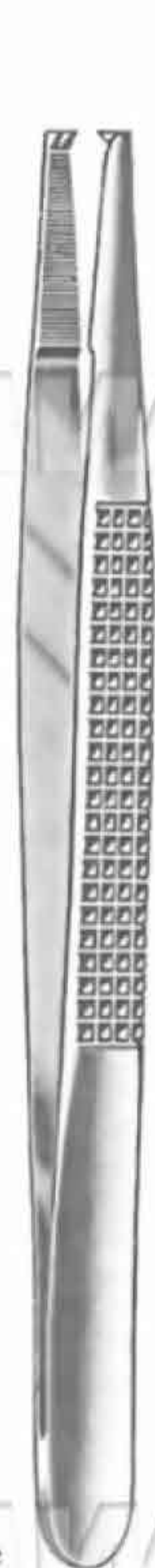
Micro-Adson



Duval



Russ. Modell



Bonney
18.0 cm / 7"

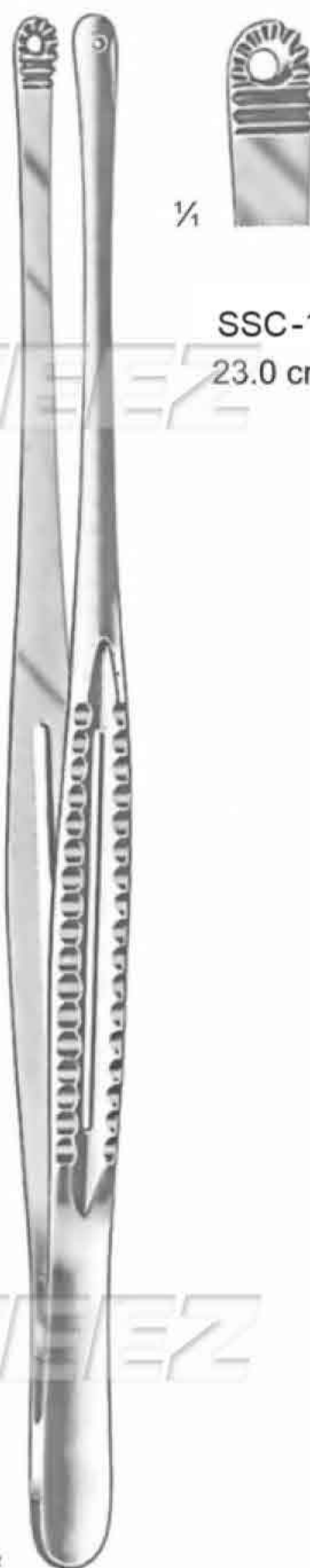


SSC-11-14-64
1x2 Teeth



SSC-11-14-65
2x3 Teeth

Grasping Forceps



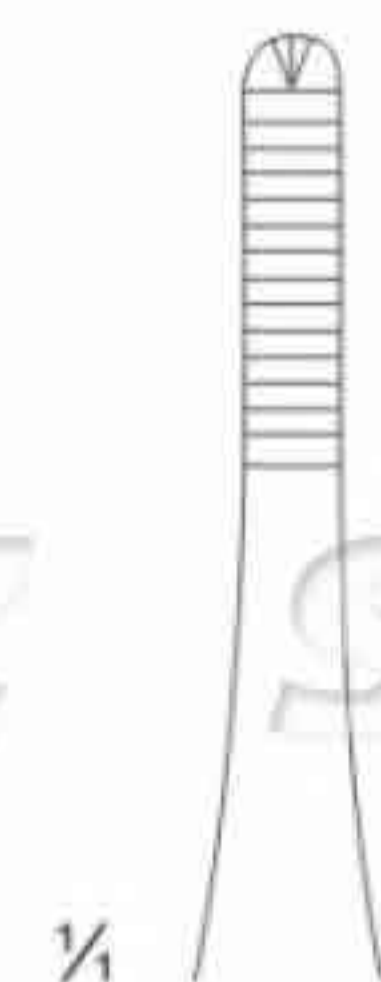
Mayo-Russ



SSC-11-14-68
23.0 cm / 9"



Ferris-Smith
18.0 cm / 7"

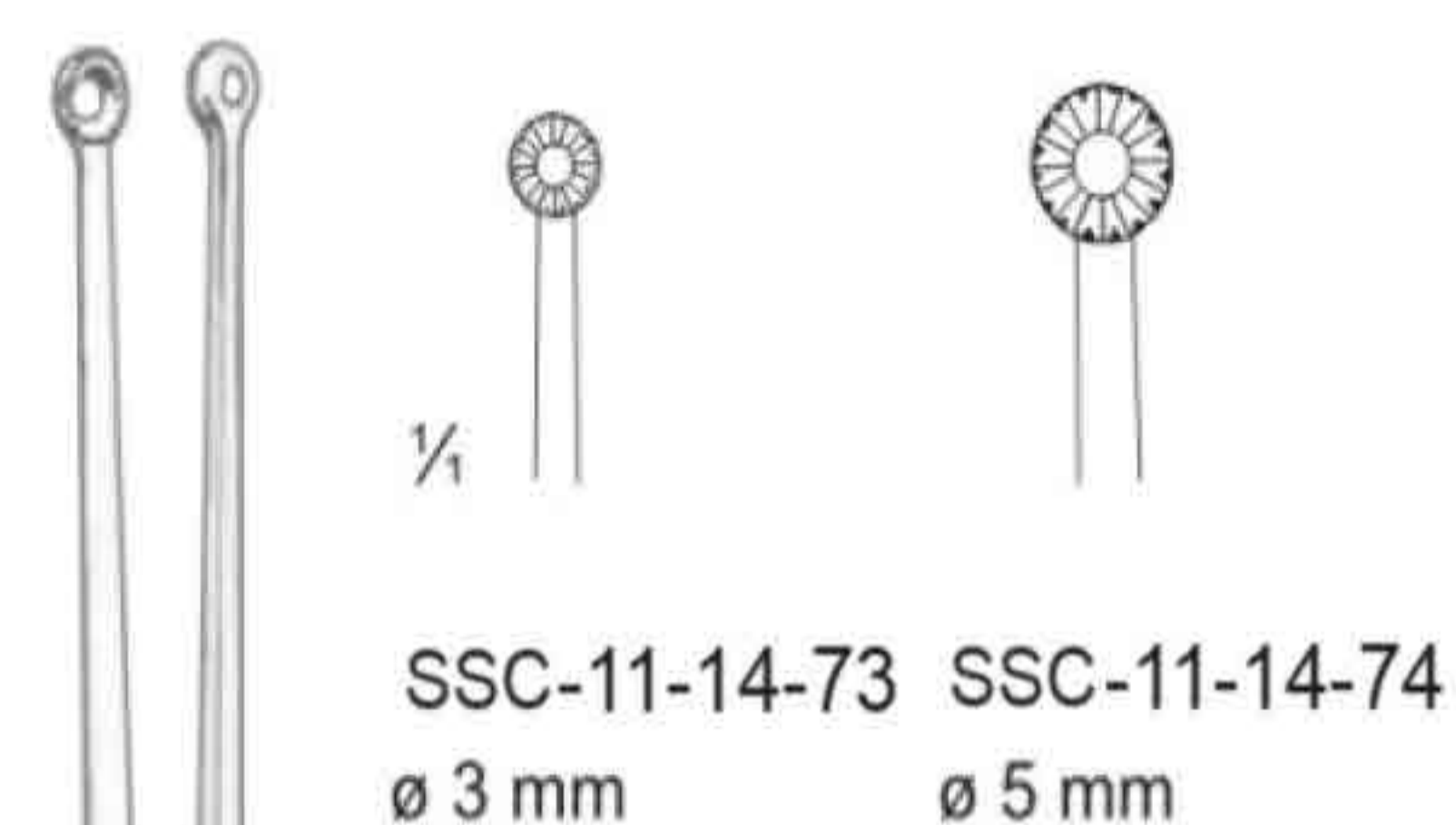
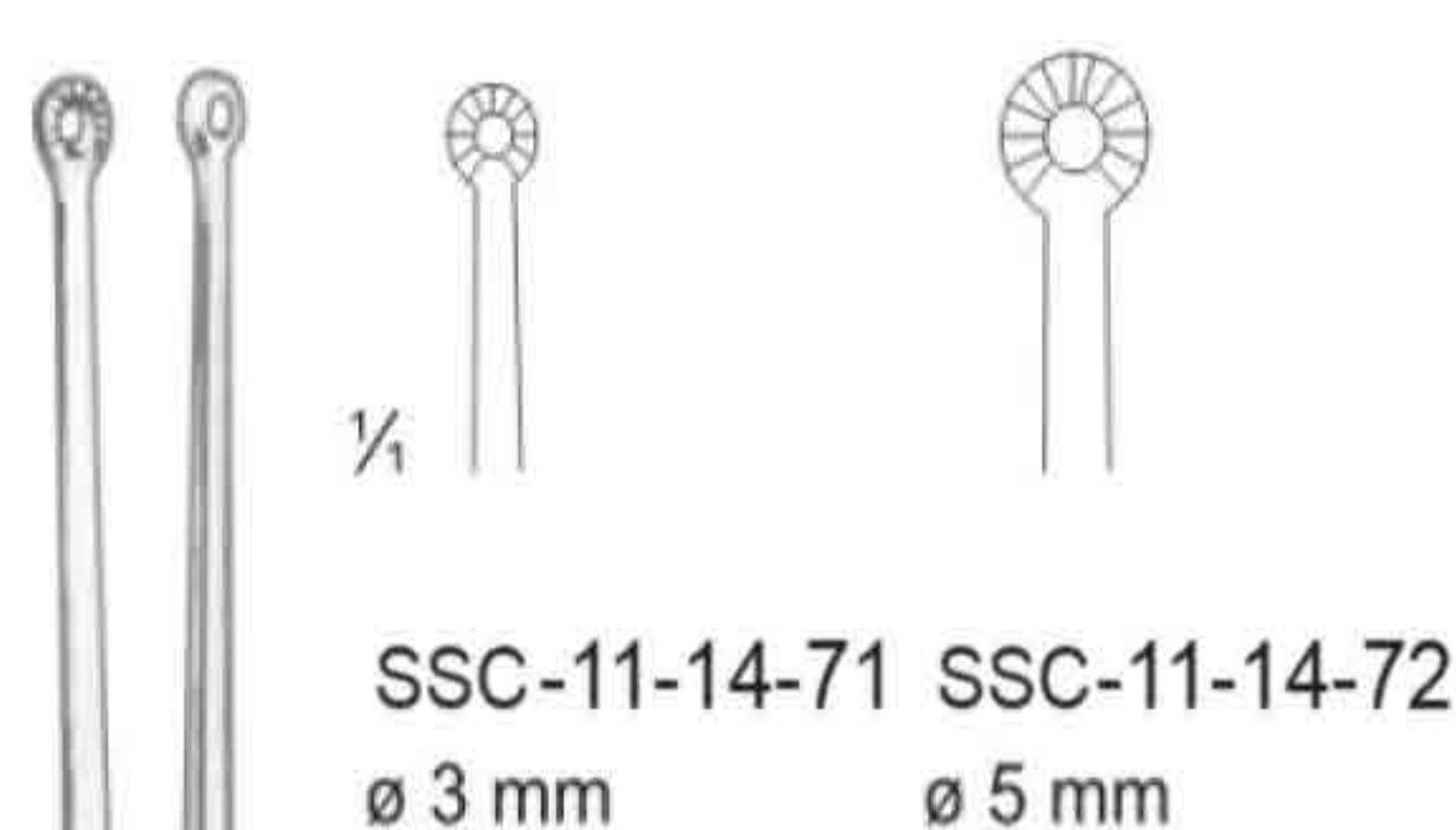
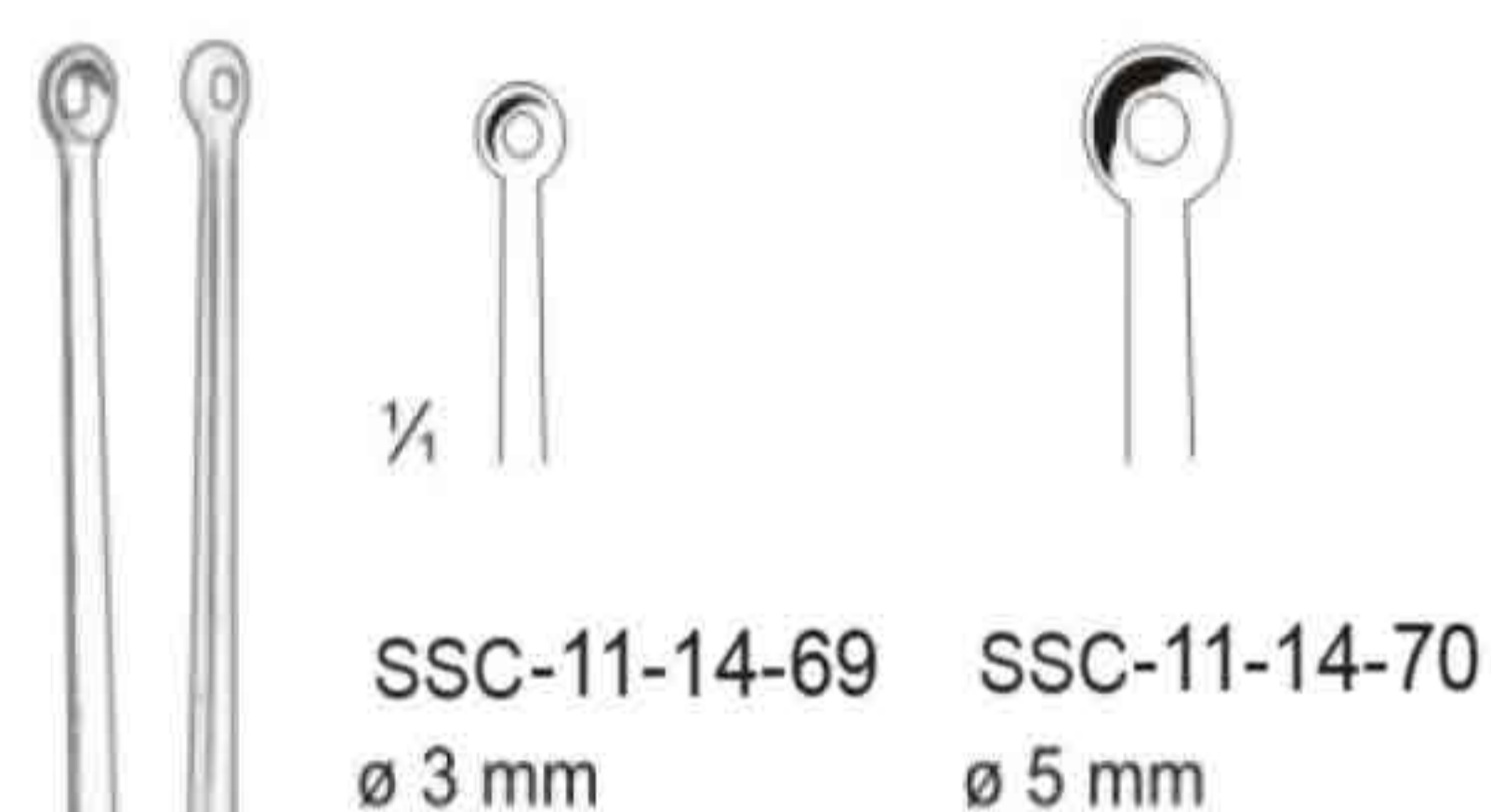


SSC-11-14-66
1x2 Teeth



SSC-11-14-67
2x3 Teeth

SAWEEZ SAWEEZ SAWEEZ SAWEEZ



SAWEEZ SAWEEZ SAWEEZ SAWEEZ

SAWEEZ SAWEEZ SAWEEZ SAWEEZ

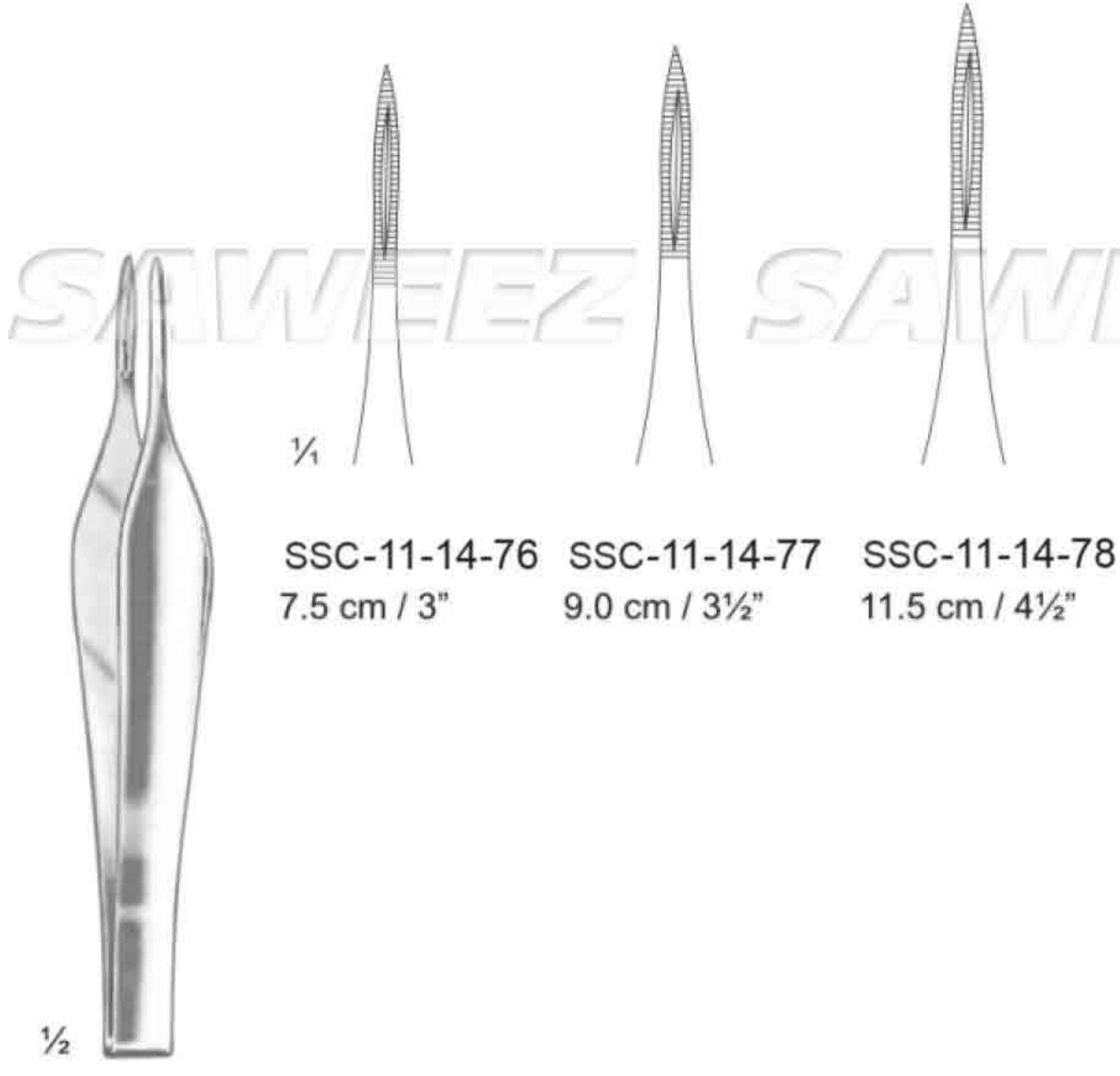
Yasargil

Yasargil

Heifetz

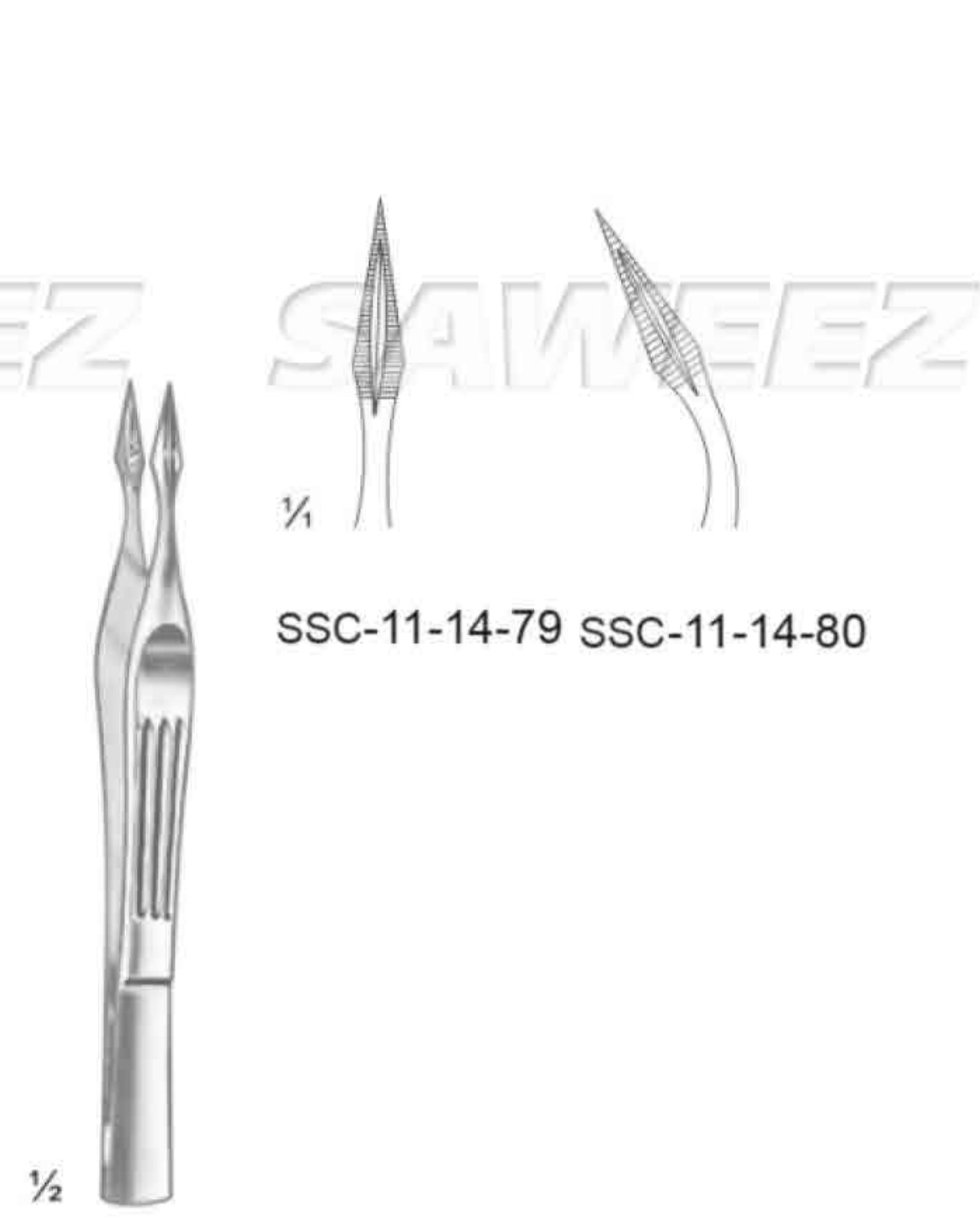


1/4
SSC-11-14-75
12.5 cm / 5"



SSC-11-14-76 7.5 cm / 3"
SSC-11-14-77 9.0 cm / 3 1/2"
SSC-11-14-78 11.5 cm / 4 1/2"

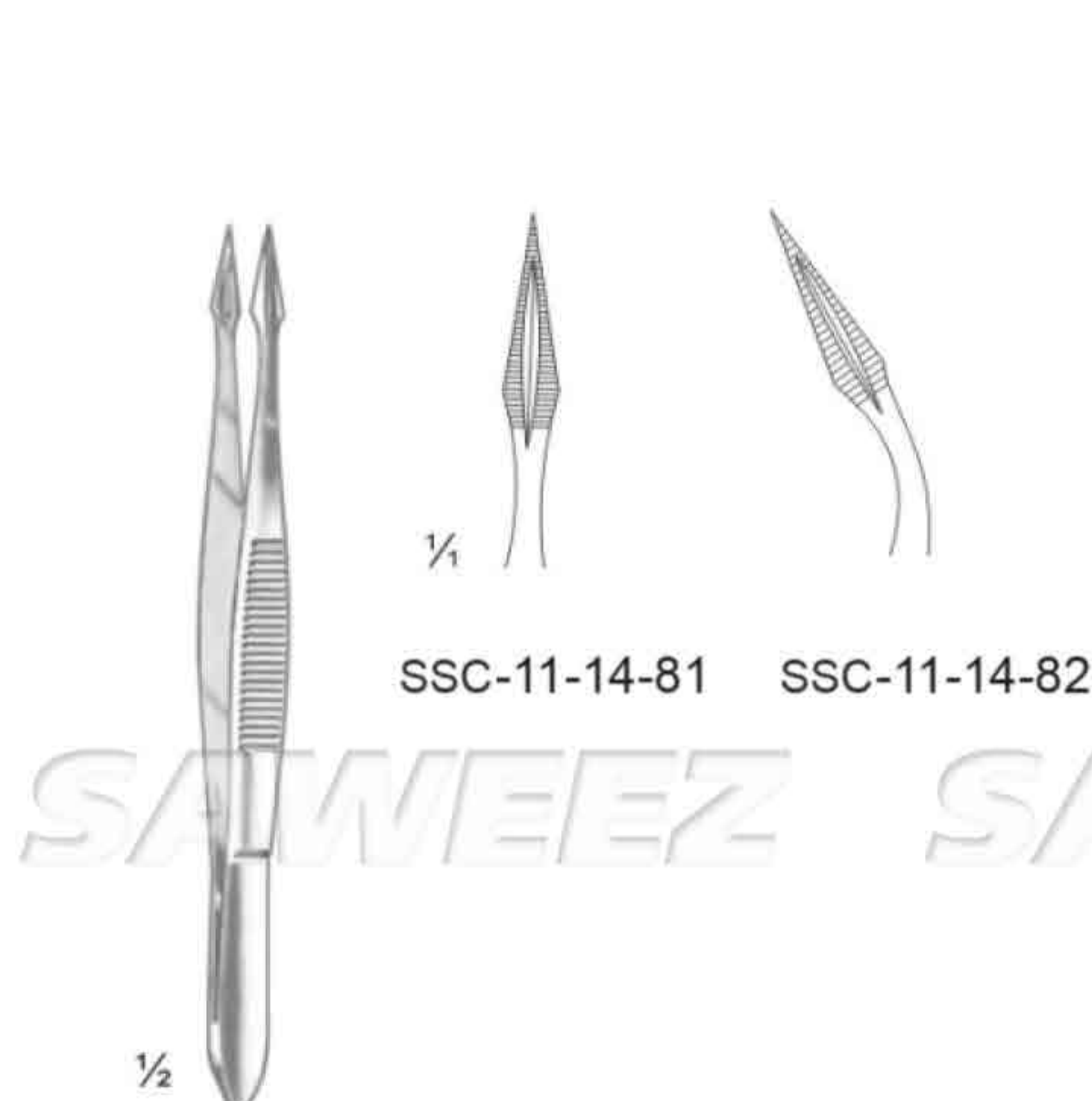
Feilchenfeld



SSC-11-14-79 SSC-11-14-80

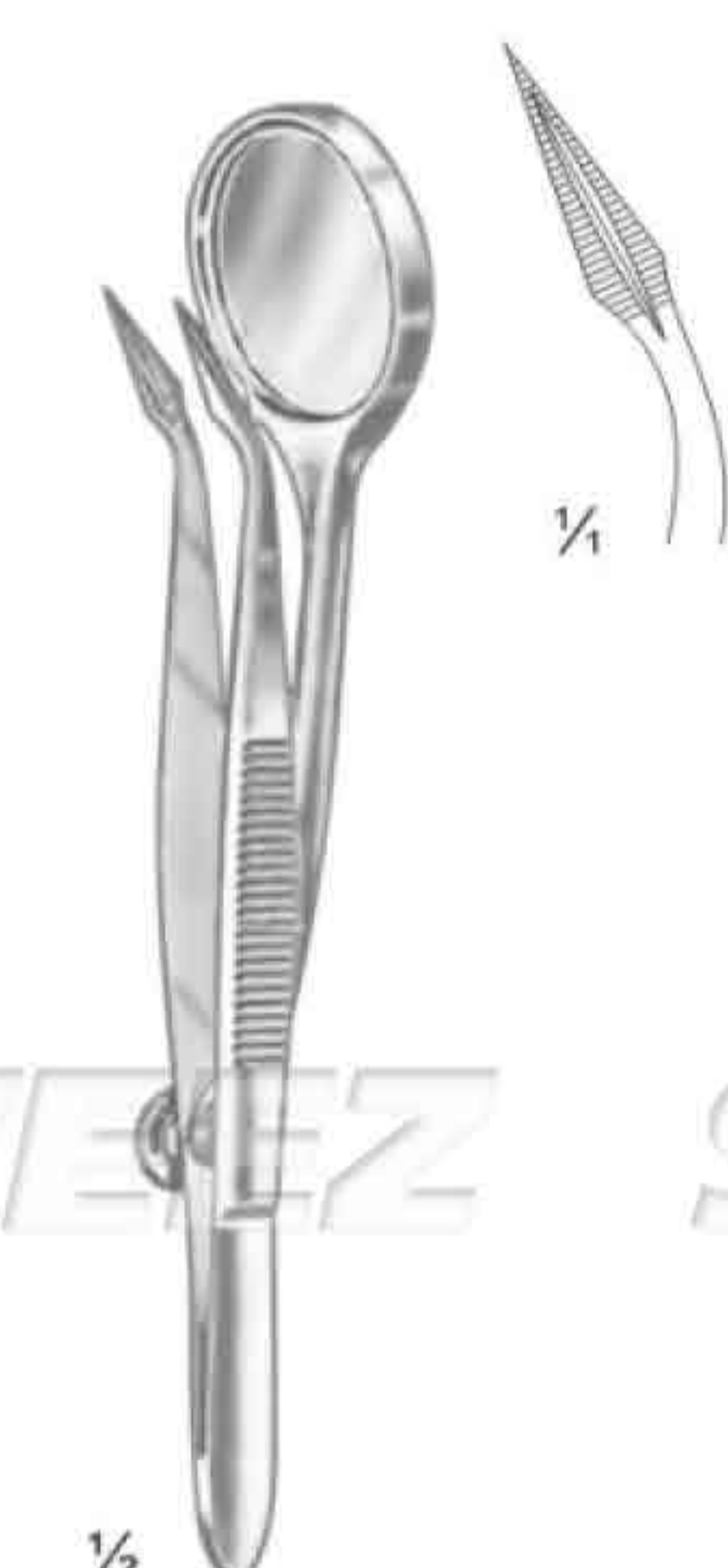
Hunter
10.5 cm / 4 1/4"

SAWEEZ SAWEEZ SAWEEZ SAWEEZ



SSC-11-14-81 SSC-11-14-82

Walter-Carmalt
10.5 cm / 4 1/4"



SSC-11-14-83
12.0 cm / 4 3/4"



SSC-11-14-84
10.0 cm / 4"

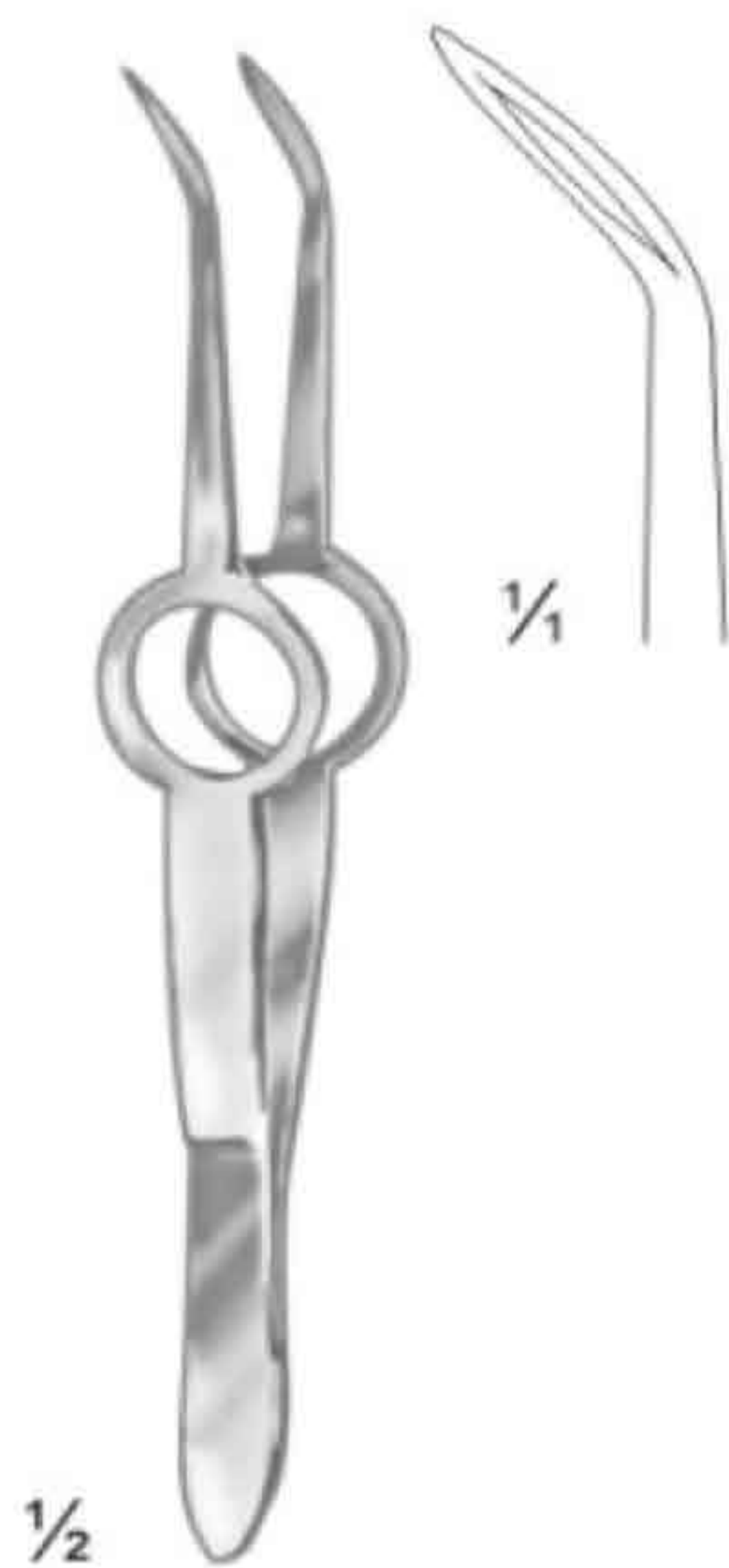


SSC-11-14-85
10.0 cm / 4"

SAWEEZ SAWEEZ SAWEEZ SAWEEZ

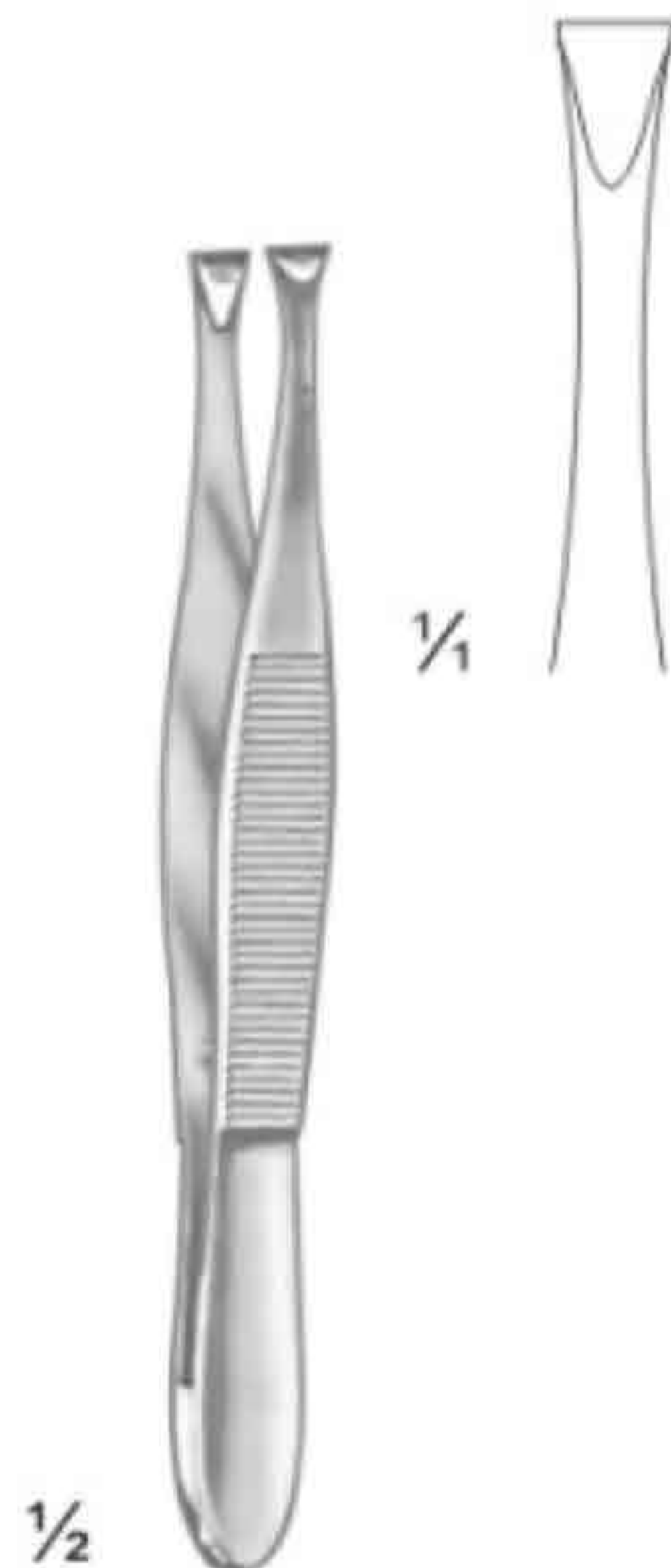


S

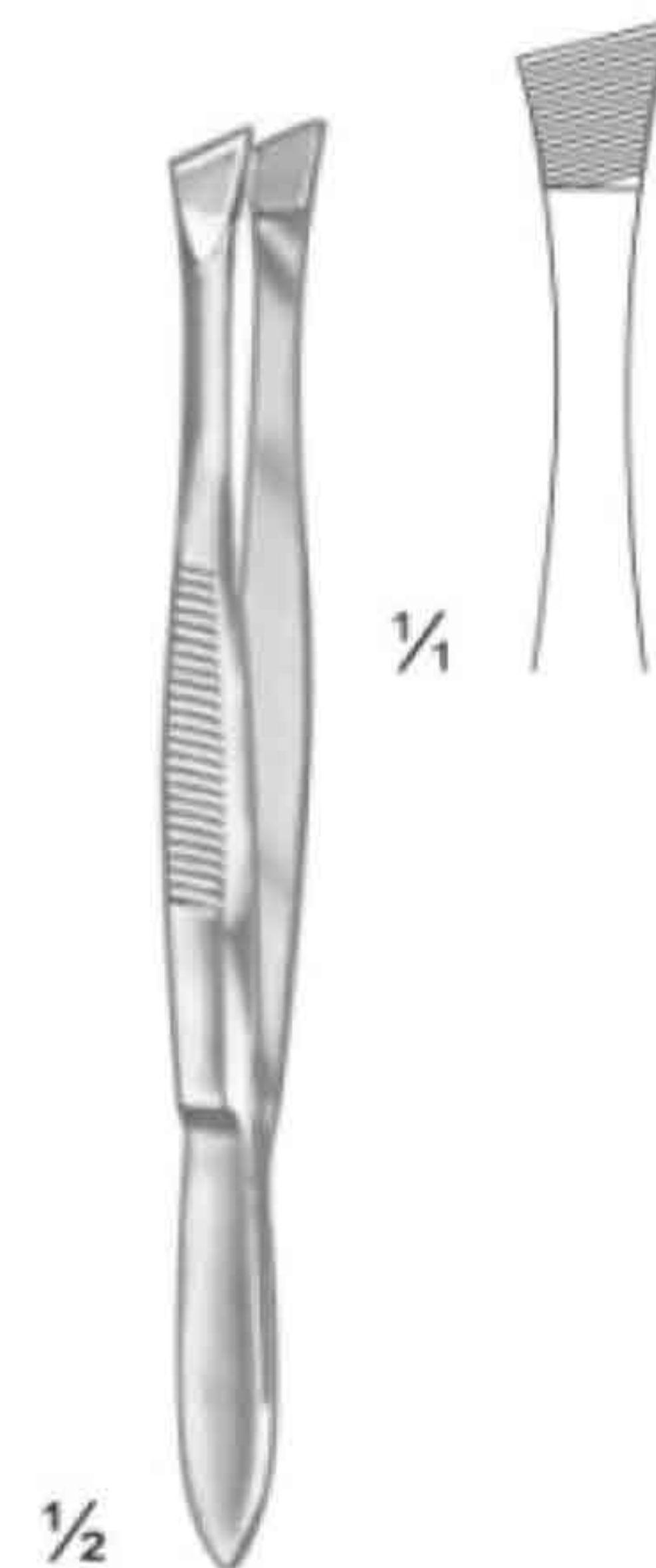


Shaaf
SSC-11-14-86
9.0 cm / 3 1/2"

S



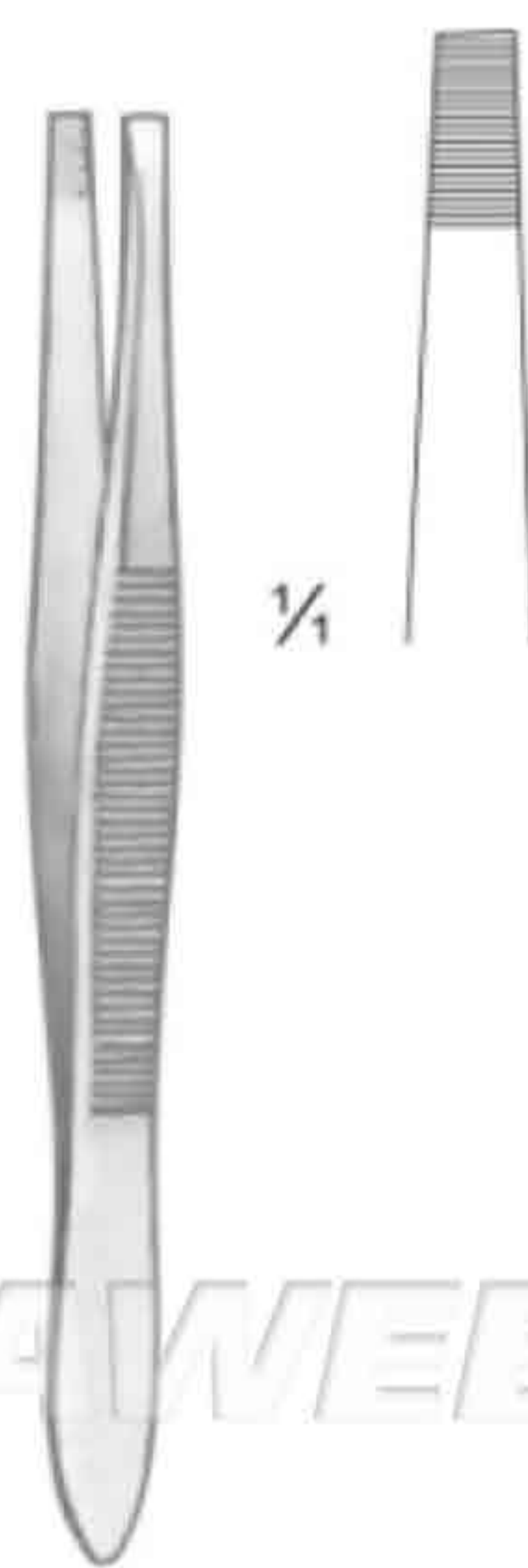
Littauer
SSC-11-14-87
8.5 cm / 3 1/2"



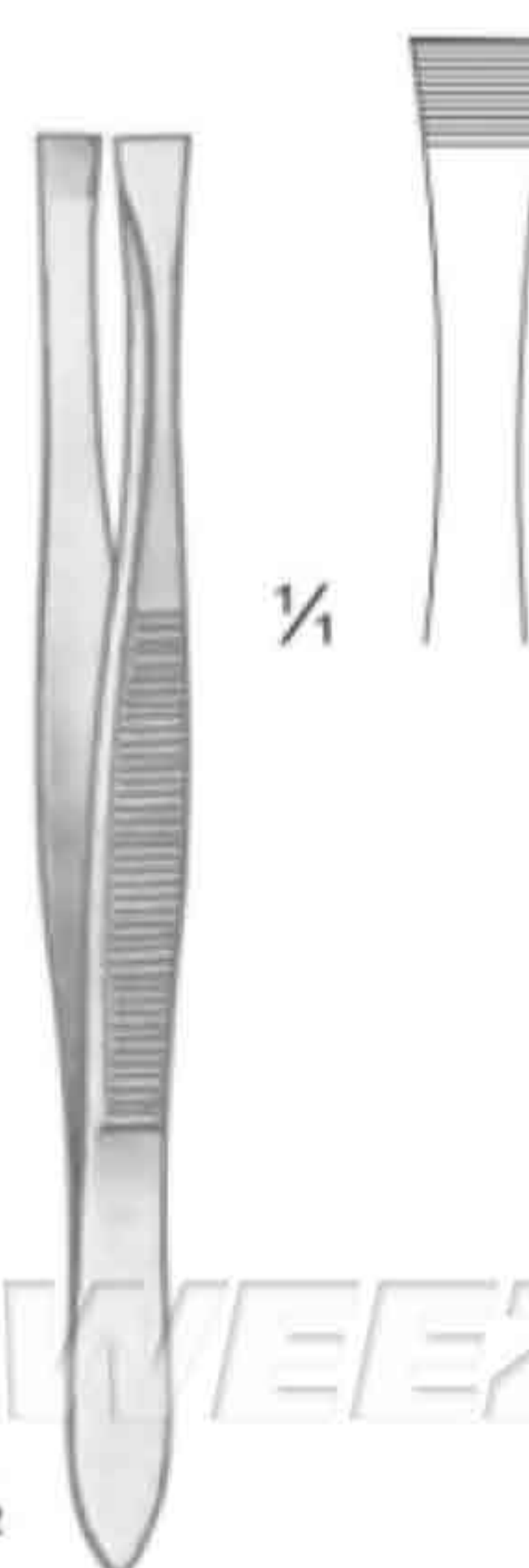
SSC-11-14-88
9.0 cm / 3 1/2"

EEZ

EEZ



Douglas
SSC-11-14-89
9.0 cm / 3 1/2"



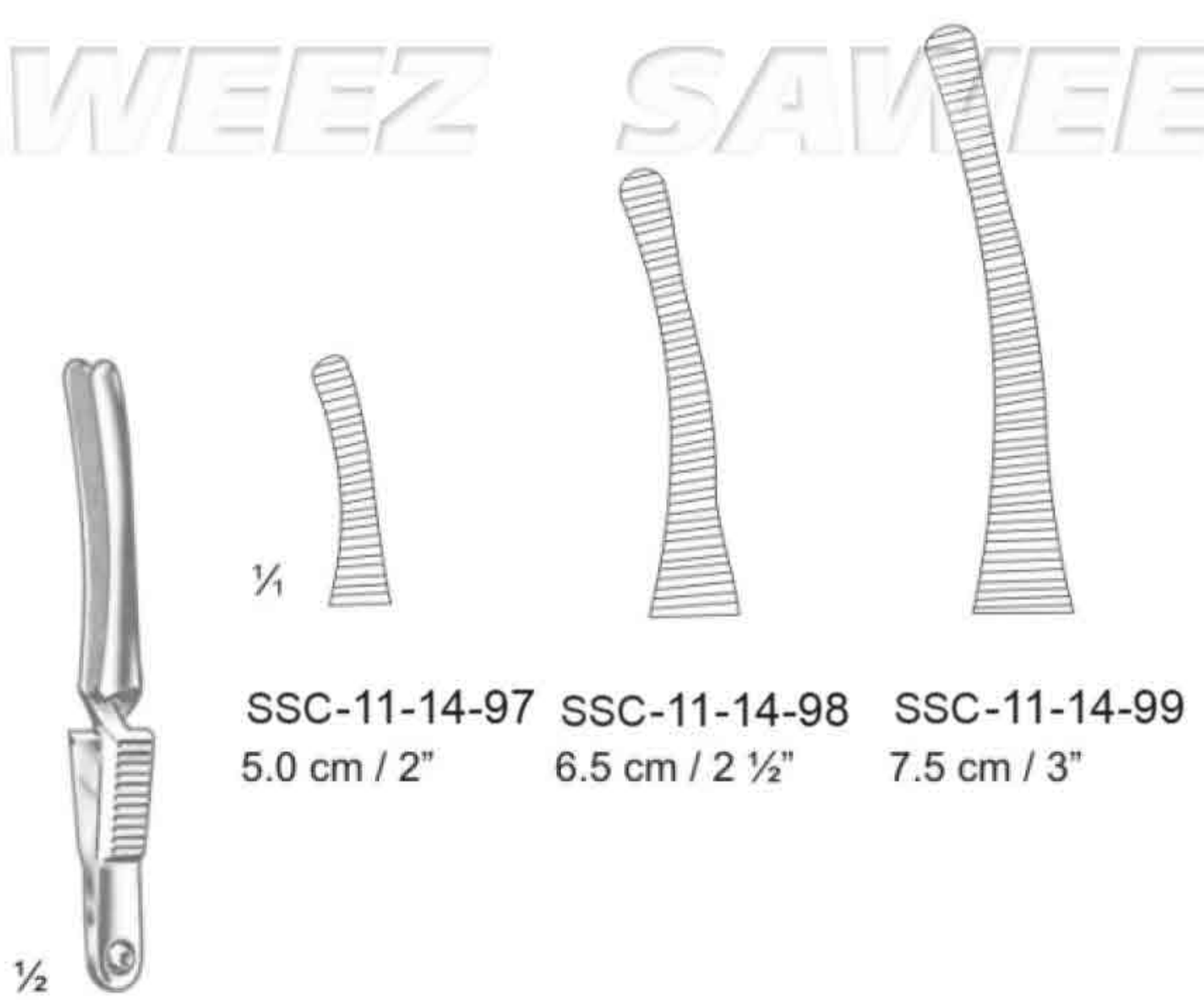
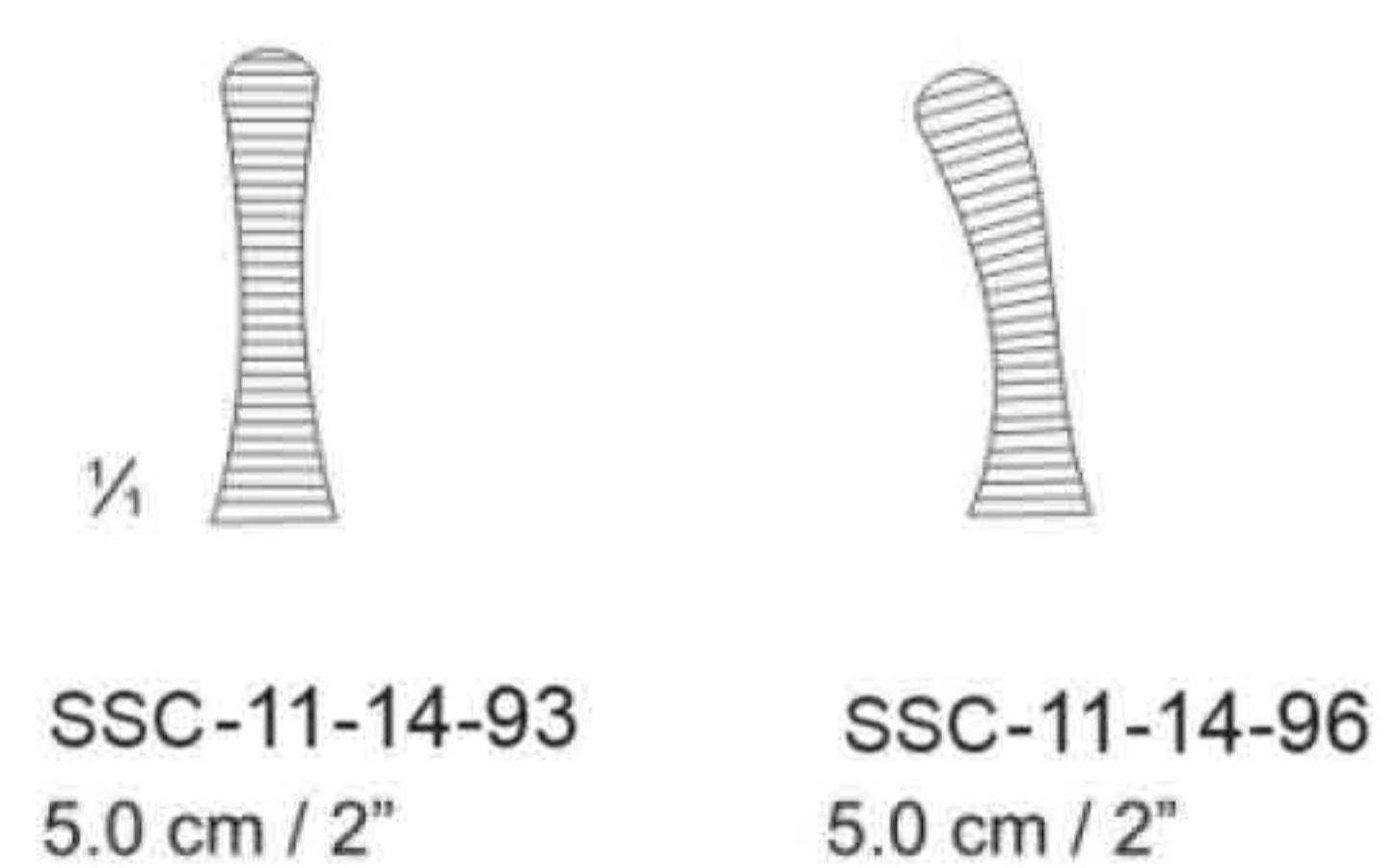
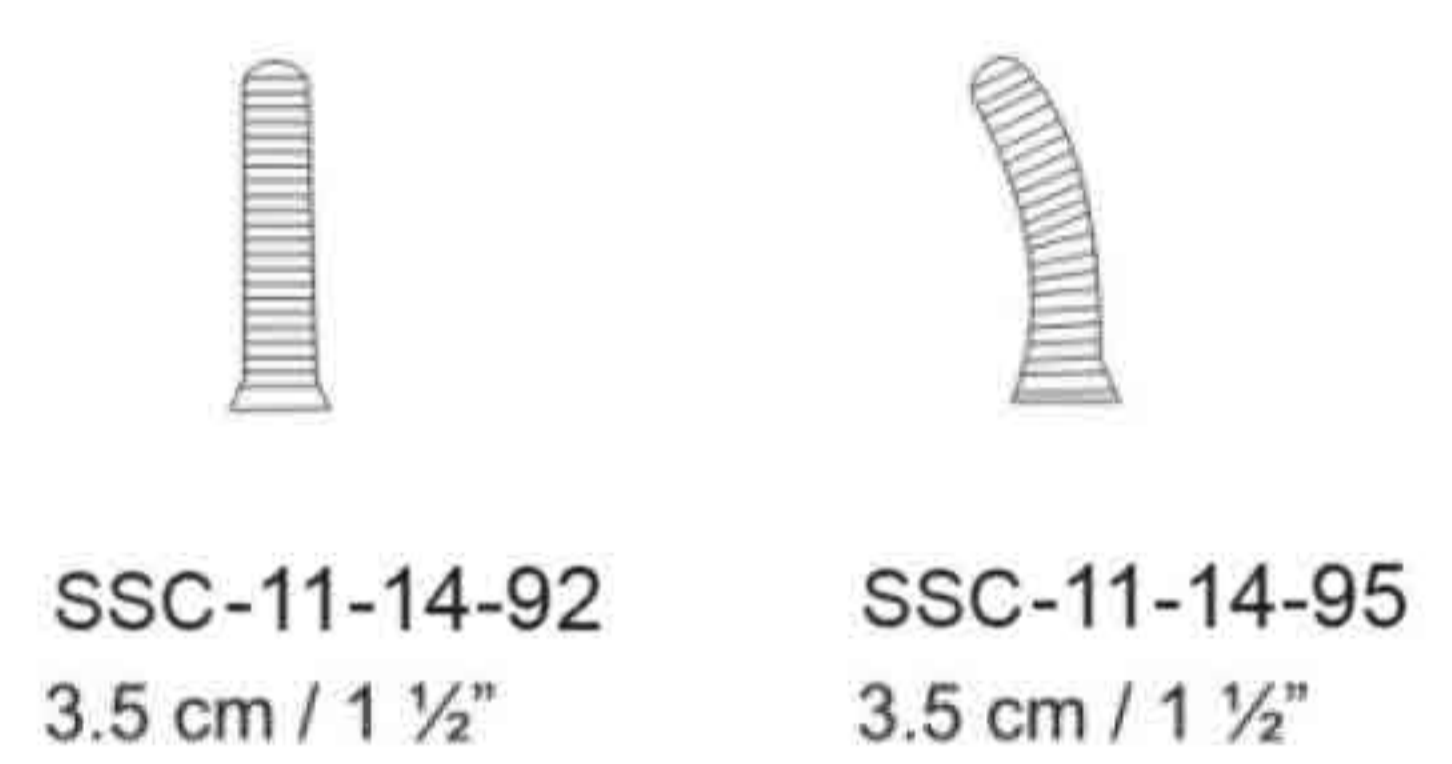
Douglas
SSC-11-14-90
9.0 cm / 3 1/2"

SAWEEZ

SAWEEZ

SAWEEZ

SAWEEZ



Dieffenbach

Johns Hopkins



	SSC-11-15-00	SSC-11-15-01	SSC-11-15-02		SSC-11-15-03	SSC-11-15-04	SSC-11-15-05
Lenght	50 mm	50 mm	60 mm		50 mm	50 mm	60 mm
Jaws	8 mm	12 mm	20 mm		8 mm	12 mm	20 mm
Weight	3 gr.	3 gr.	3 gr.		3 gr.	3 gr.	3 gr.
Pressure	50 gr.	50 gr.	50 gr.		50 gr.	50 gr.	50 gr.





SSC-11-15-06
14.0 cm / 5 1/2"

1/2

Collin



SSC-11-15-07
16.5 cm / 6 1/2"

1/2

Collin

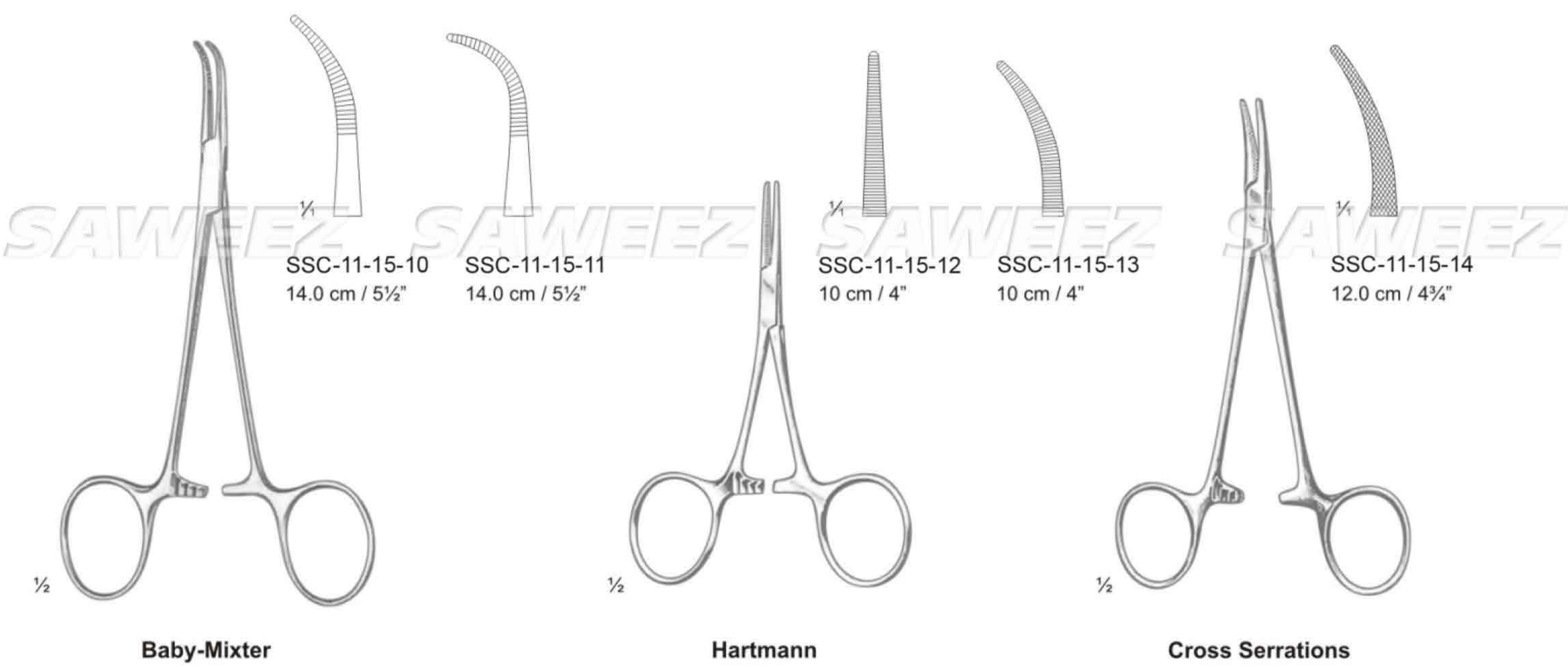


SSC-11-15-08
15.0 cm / 6"

SSC-11-15-09
20.0 cm / 8"

1/2

Pennington



Baby-Mixer

Hartmann

Cross Serrations



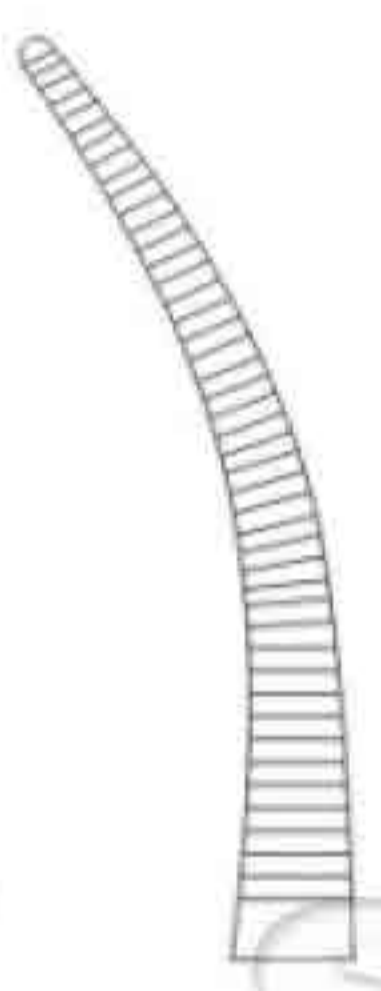
Halsted-Mosquito



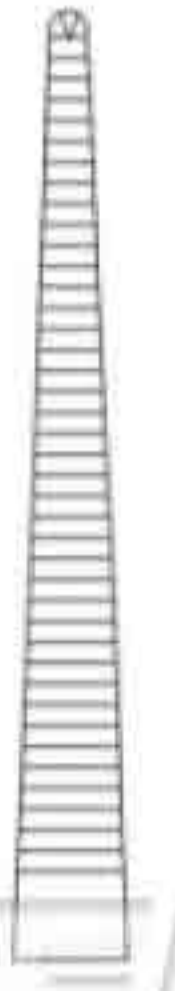
Halsted-Mosquito



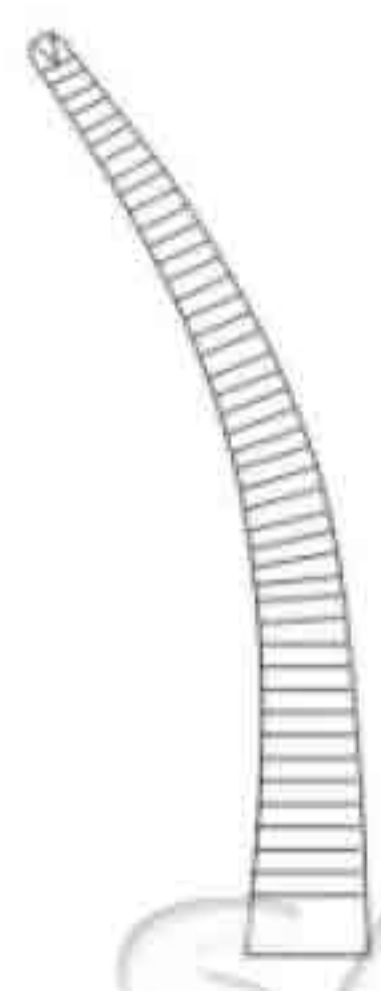
SSC-11-15-23
18.0 cm / 7"



SSC-11-15-24
18.0 cm / 7"



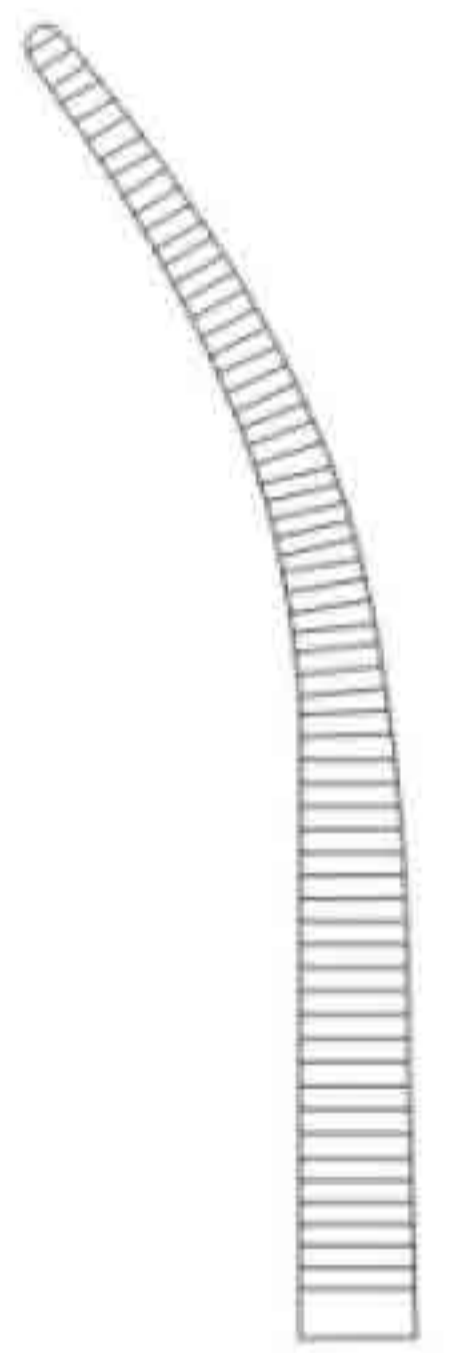
SSC-11-15-25
18.0 cm / 7"
1x2 Teeth



SSC-11-15-26
18.0 cm / 7"
1x2 Teeth



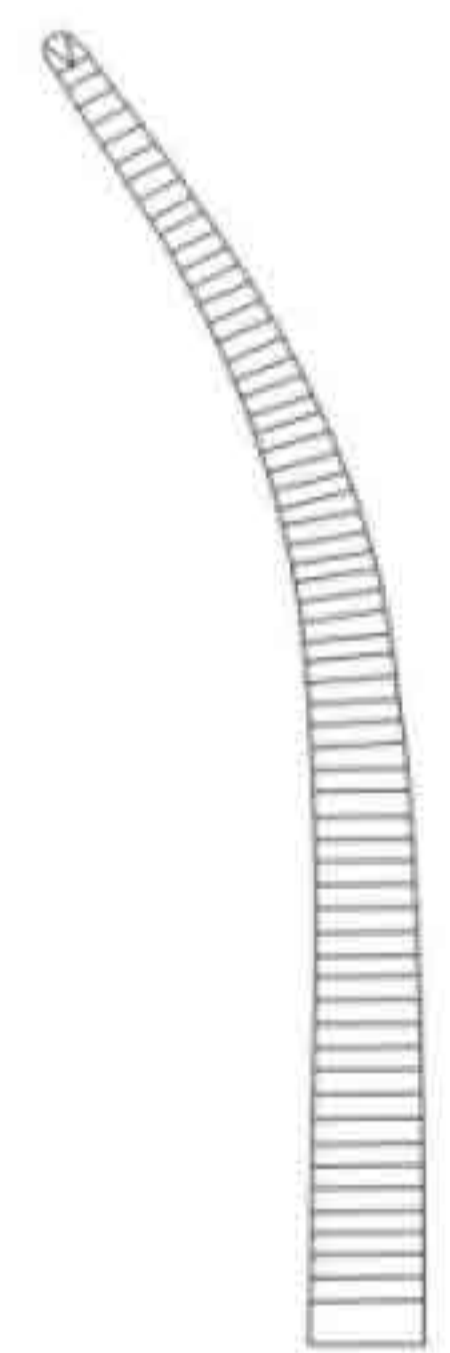
SSC-11-15-27
21.0 cm / 8¼"



SSC-11-15-28
21.0 cm / 8¼"



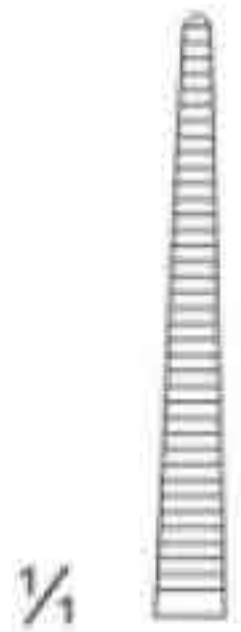
SSC-11-15-29
21.0 cm / 8¼"
1x2 Teeth



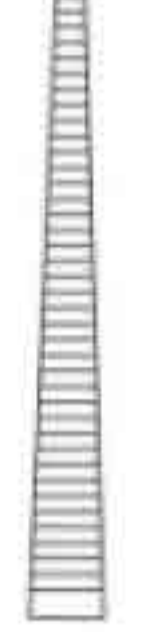
SSC-11-15-30
21.0 cm / 8¼"
1x2 Teeth



Micro-Mosquito



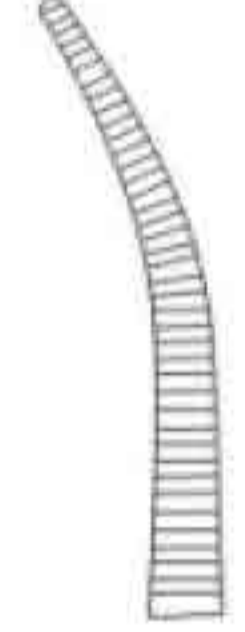
SSC-11-15-31
10.0 cm / 4"



SSC-11-15-32
12.0 cm / 4¾"



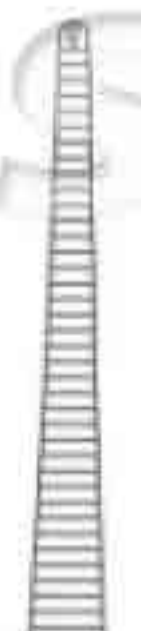
SSC-11-15-33
10.0 cm / 4"



SSC-11-15-34
12.0 cm / 4¾"



SSC-11-15-35
10.0 cm / 4"
1x2 Teeth



SSC-11-15-36
12.0 cm / 4¾"
1x2 Teeth



SSC-11-15-37
10.0 cm / 4"
1x2 Teeth



SSC-11-15-38
12.0 cm / 4¾"
1x2 Teeth

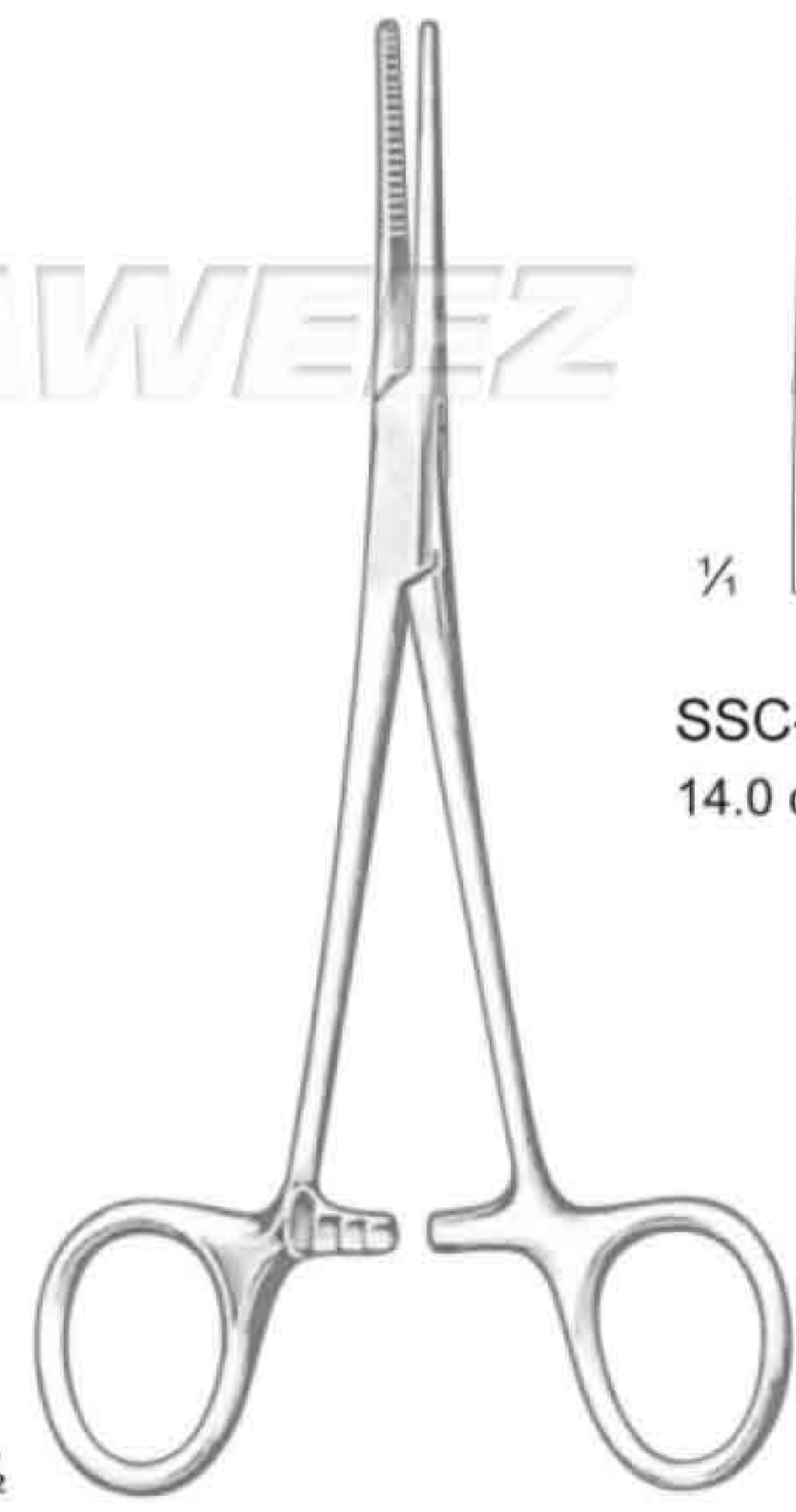


Providence-Hospital

SSC-11-15-39
14.0 cm / 5½"



SSC-11-15-40
14.0 cm / 5½"



Kelly

SSC-11-15-41
14.0 cm / 5½"



SSC-11-15-42
14.0 cm / 5½"

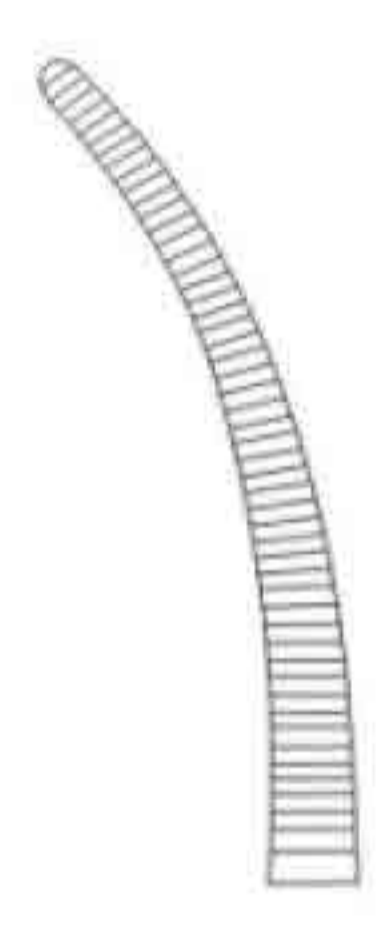


Leriche

SSC-11-15-43
15.0 cm / 6"



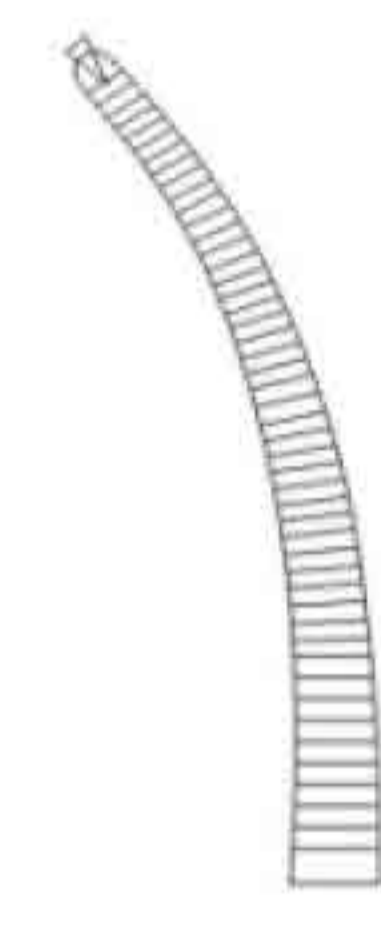
SSC-11-15-44
15.0 cm / 6"



SSC-11-15-45
15.0 cm / 6"
1x2 Teeth



SSC-11-15-46
15.0 cm / 6"
1x2 Teeth





Rankin-Kelly



SSC-11-15-47
16.0 cm / 6 1/4"



SSC-11-15-48
16.0 cm / 6 1/4"



Baby-Overholt



SSC-11-15-49
13.5 cm / 5 1/4"



Crile



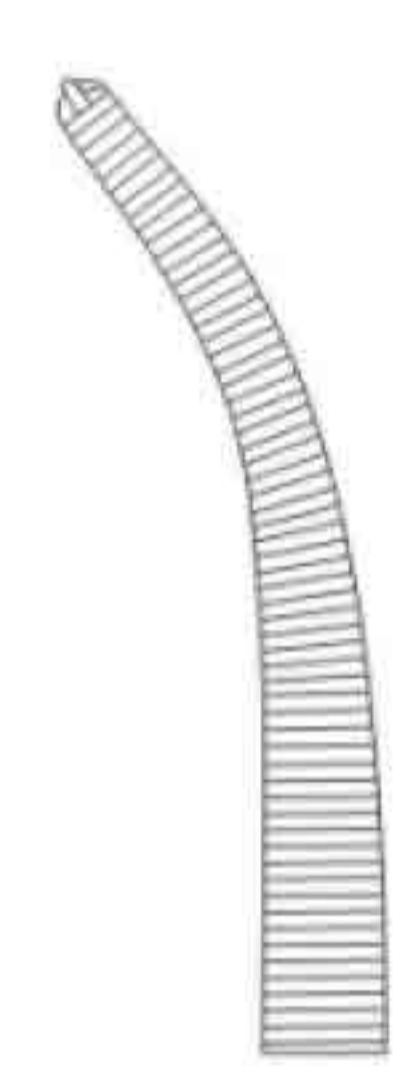
SSC-11-15-50
14.0 cm / 5 1/2"



SSC-11-15-51
14.0 cm / 5 1/2"



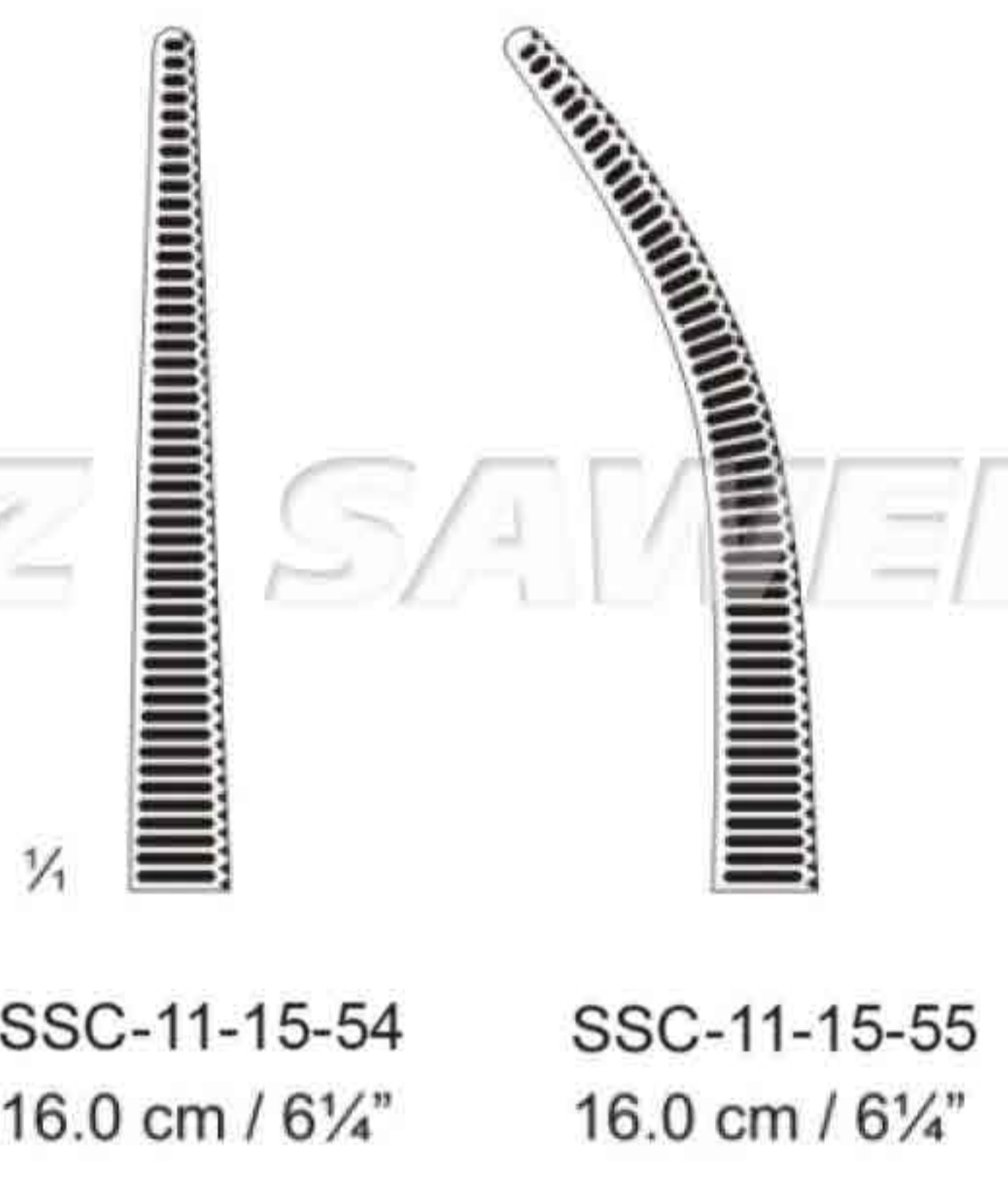
SSC-11-15-52
14.0 cm / 5 1/2"
1x2 Teeth



SSC-11-15-53
14.0 cm / 5 1/2"
1x2 Teeth

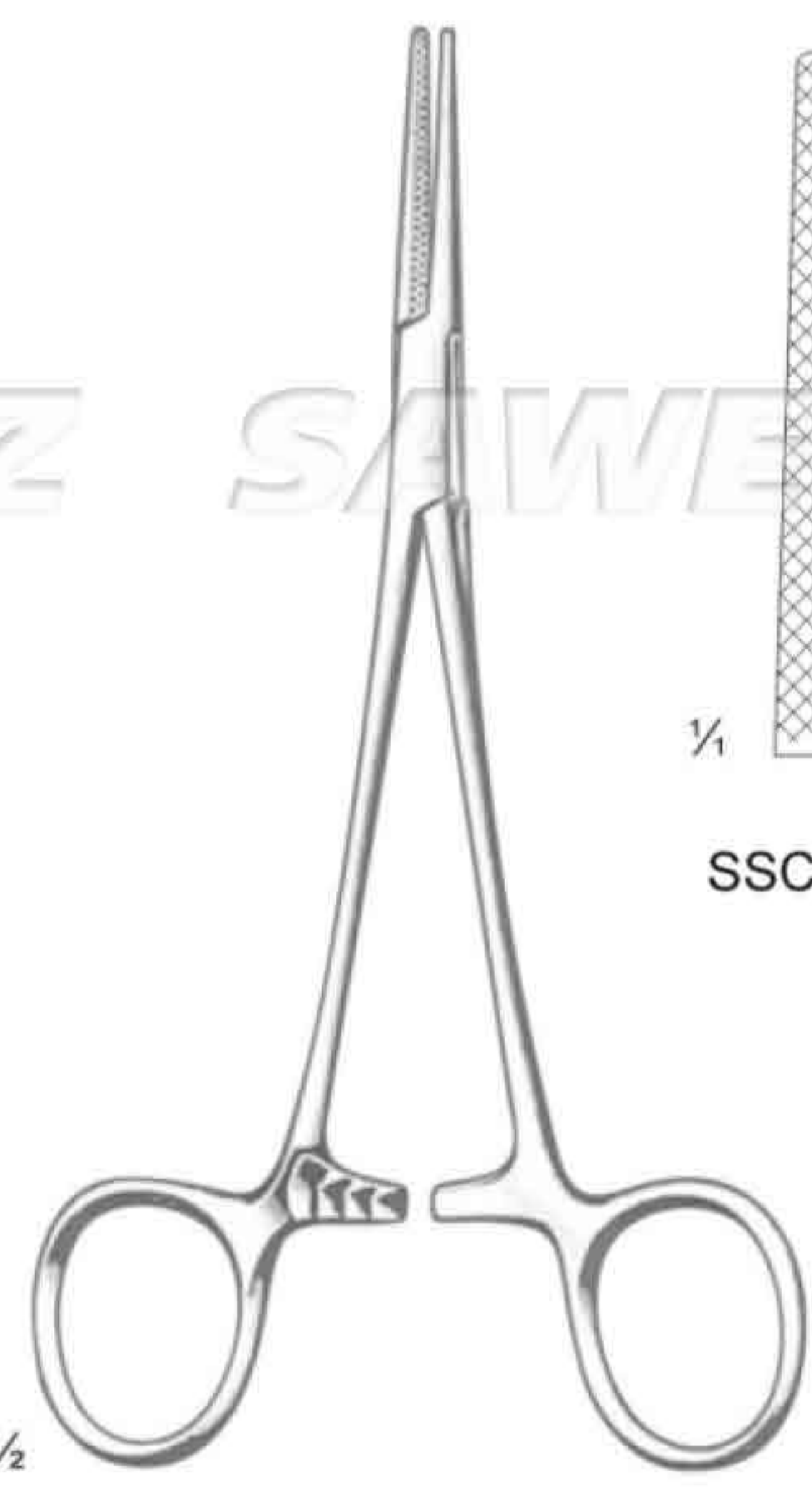


Rankin-Crile

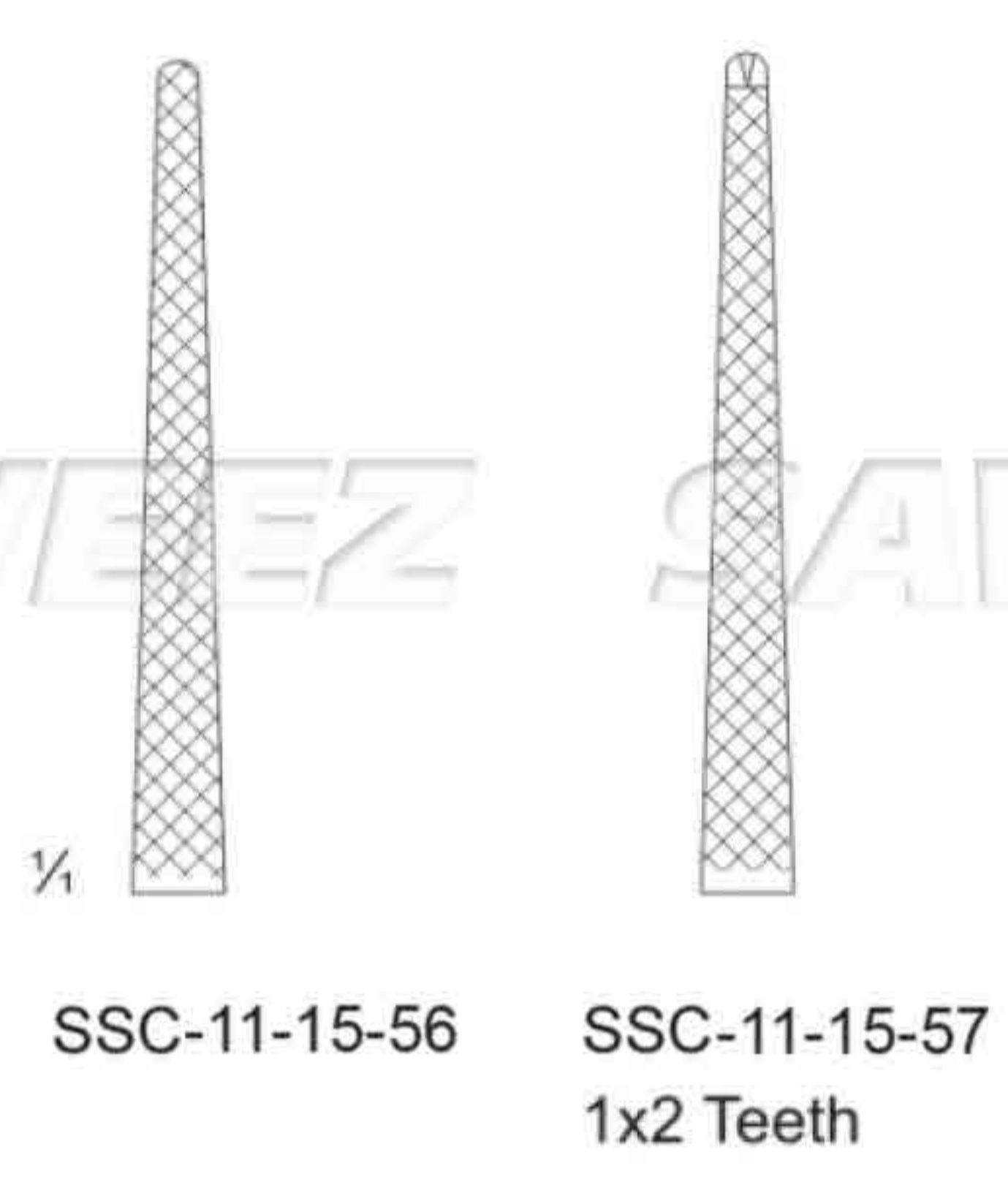


SSC-11-15-54
16.0 cm / 6 1/4"

SSC-11-15-55
16.0 cm / 6 1/4"

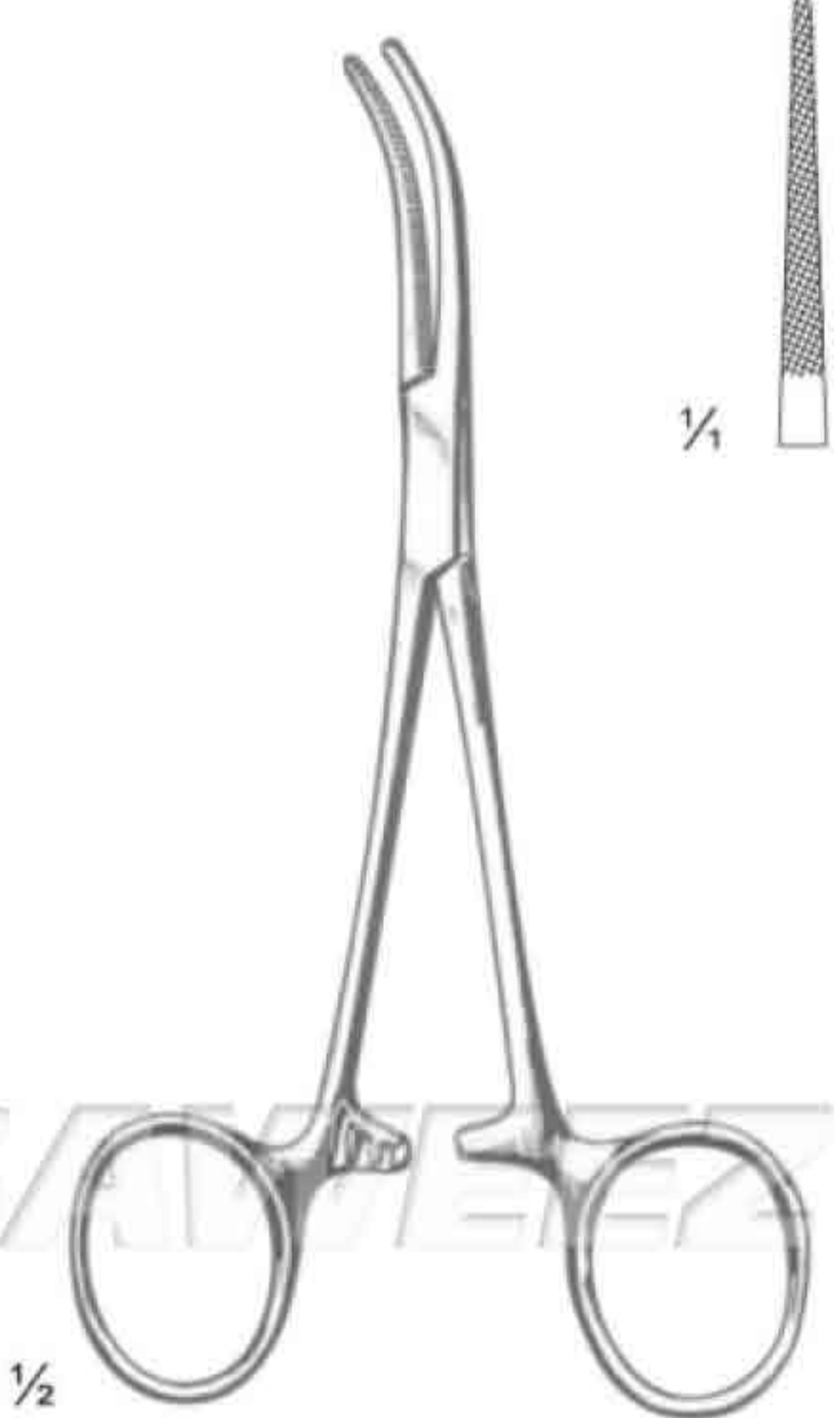


Lovlace

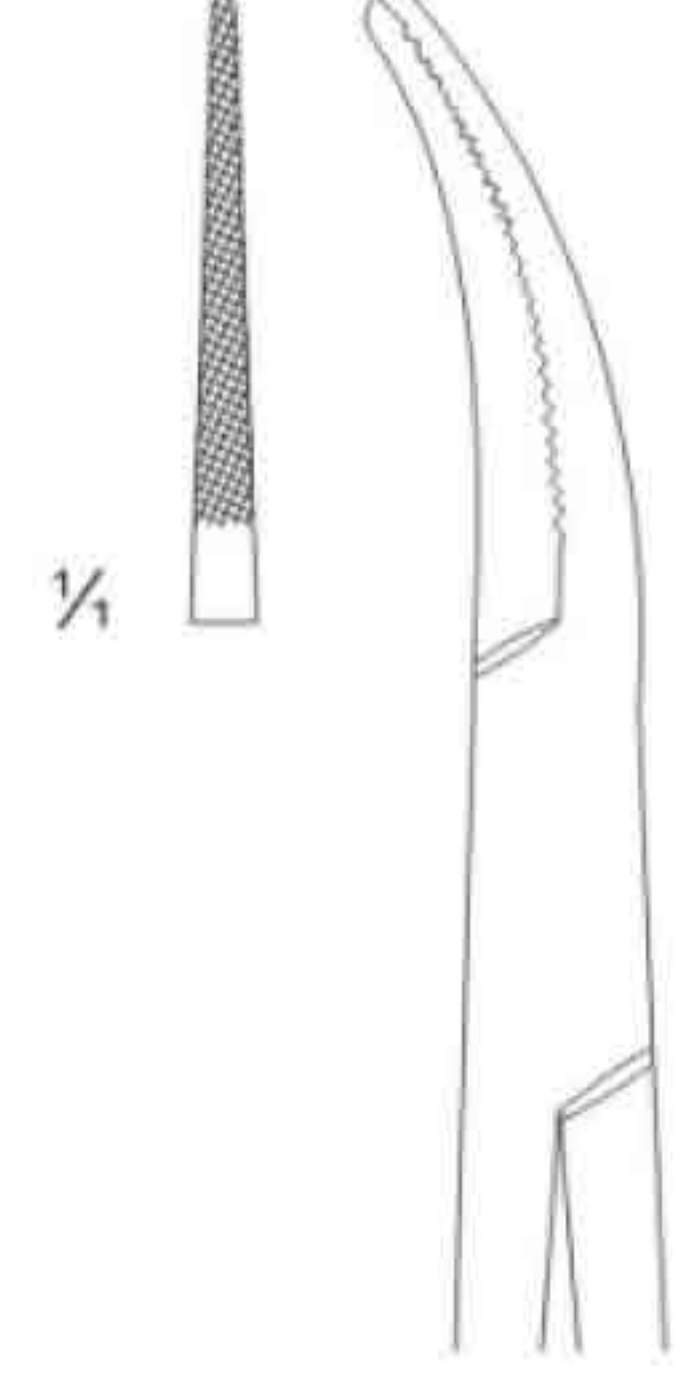


SSC-11-15-56

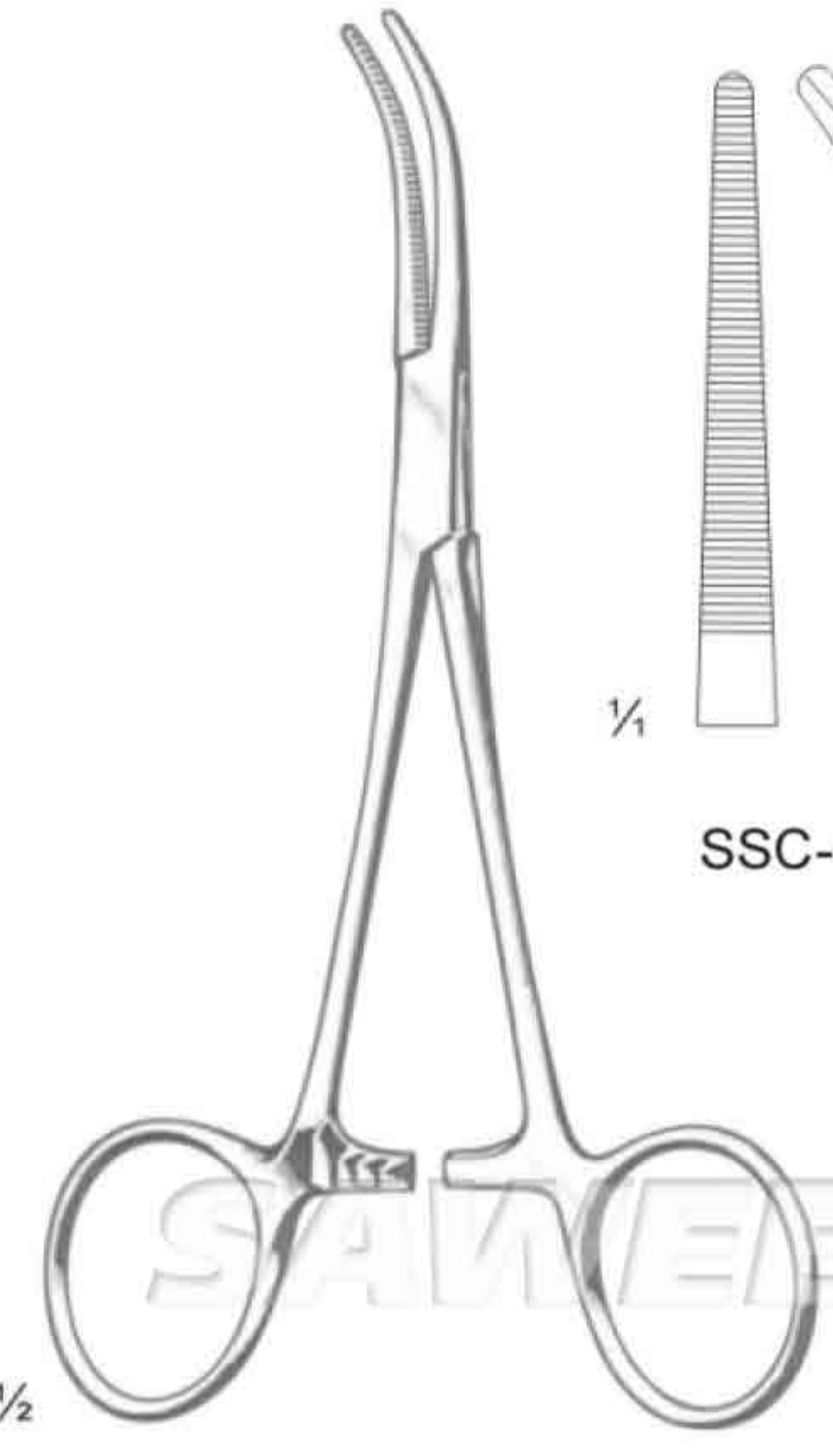
SSC-11-15-57
1x2 Teeth



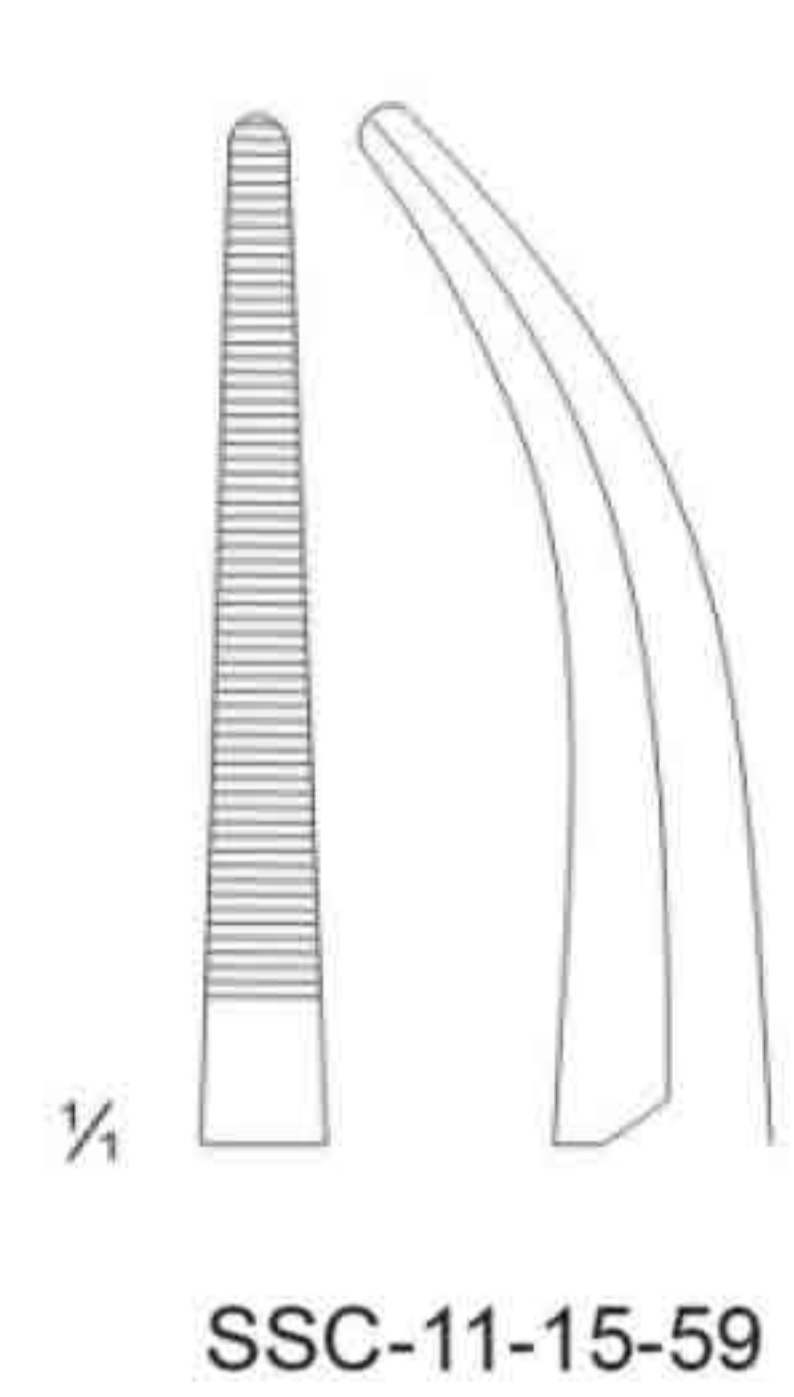
Mosquito-Dandy



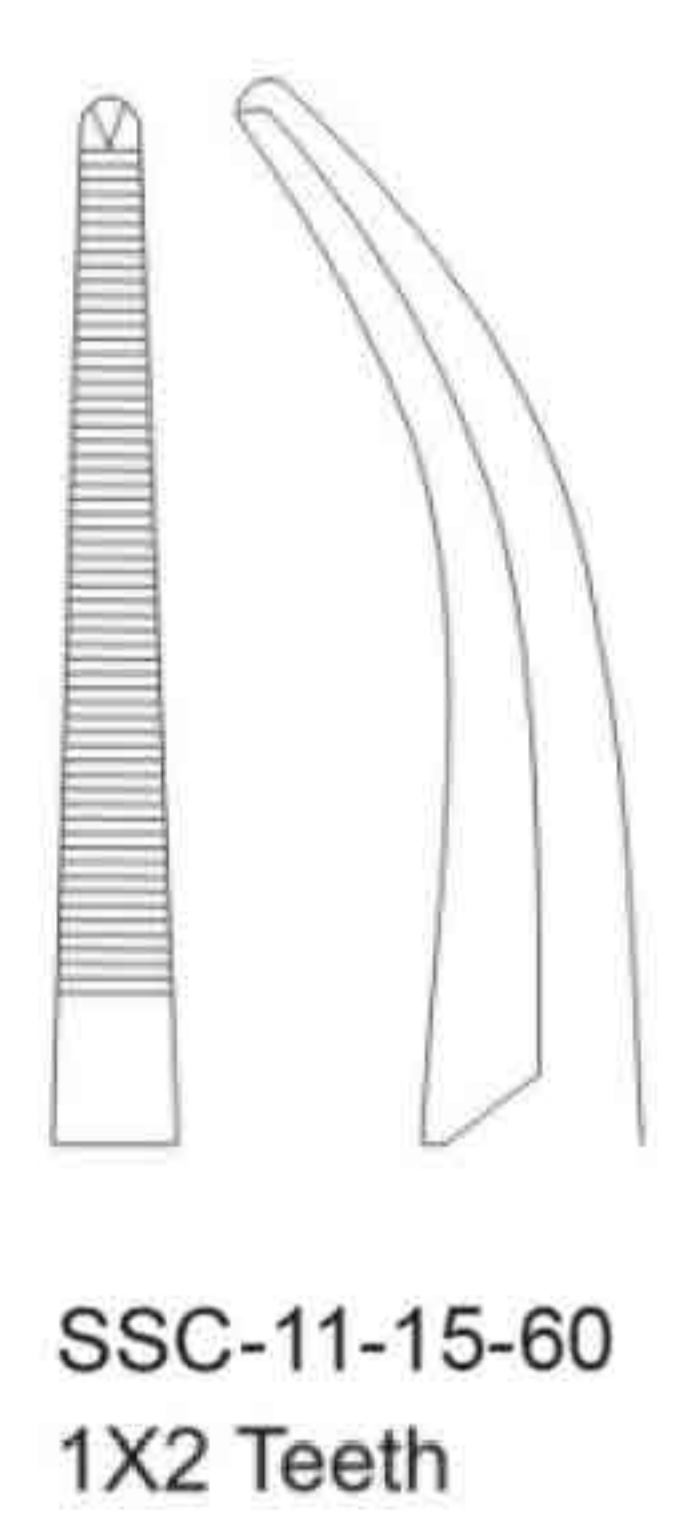
SSC-11-15-58
12.0 cm / 4 3/4"



Dandy



SSC-11-15-59

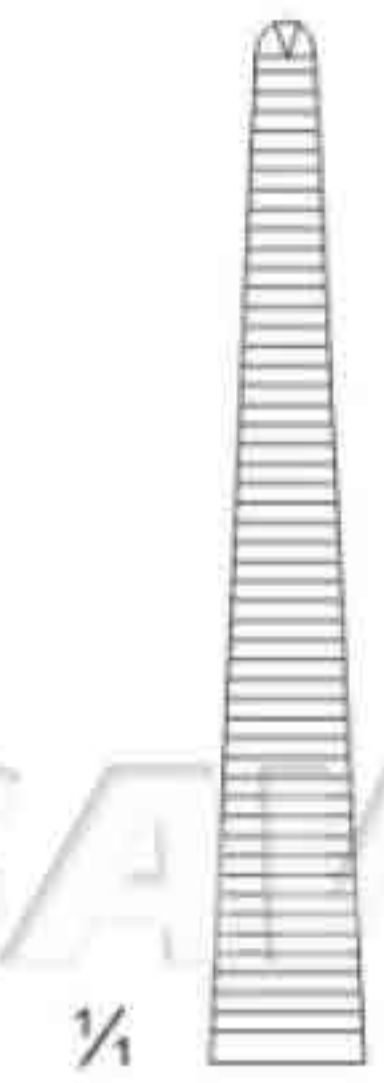


SSC-11-15-60
1X2 Teeth



1/2

Adson

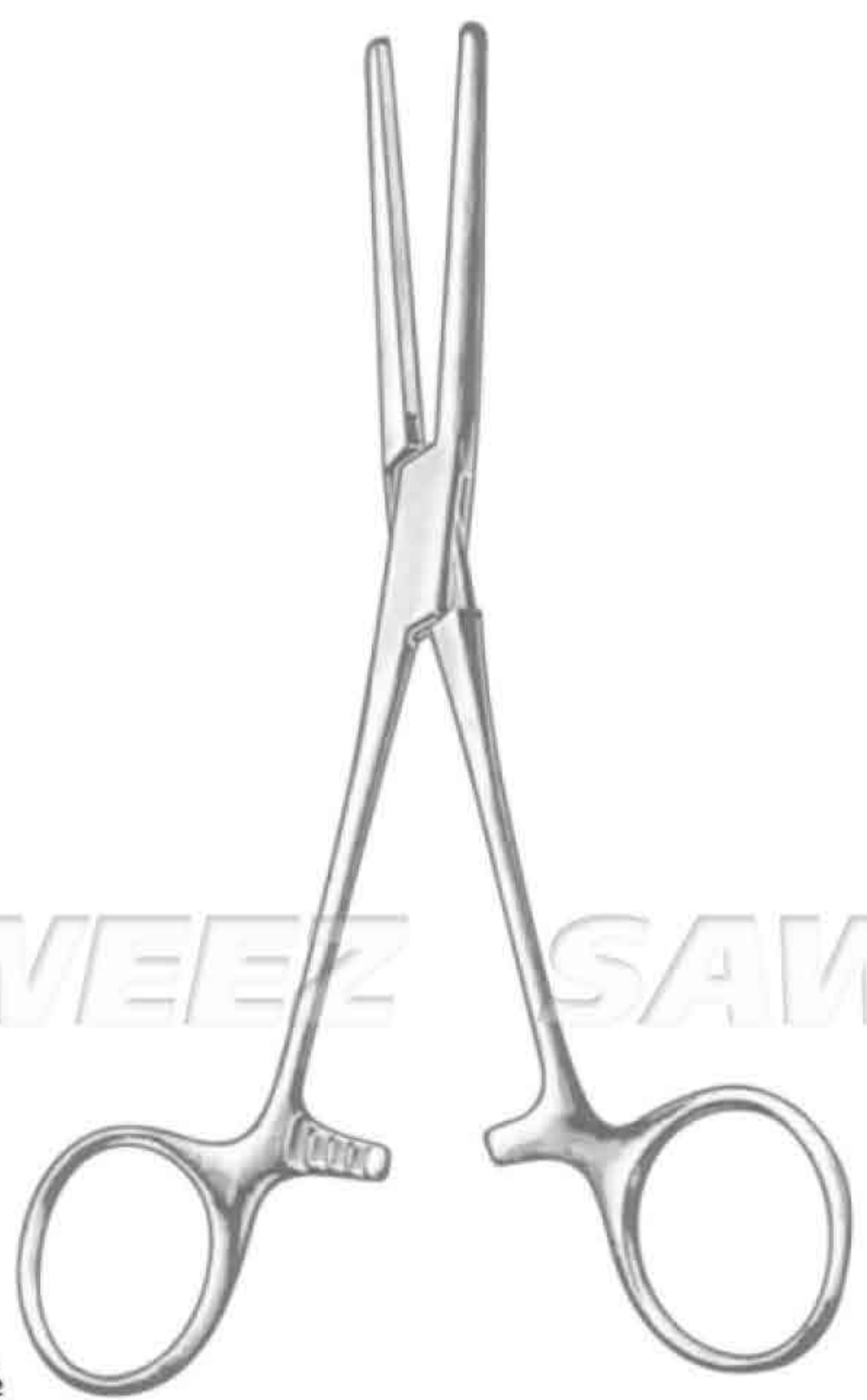


1/4

SSC -11-15-61
18.5 cm / 7 1/4"
1x2 Teeth



SSC -11-15-62
18.5 cm / 7 1/4"
1x2 Teeth



1/2

Rochester-Carmalt



1/4

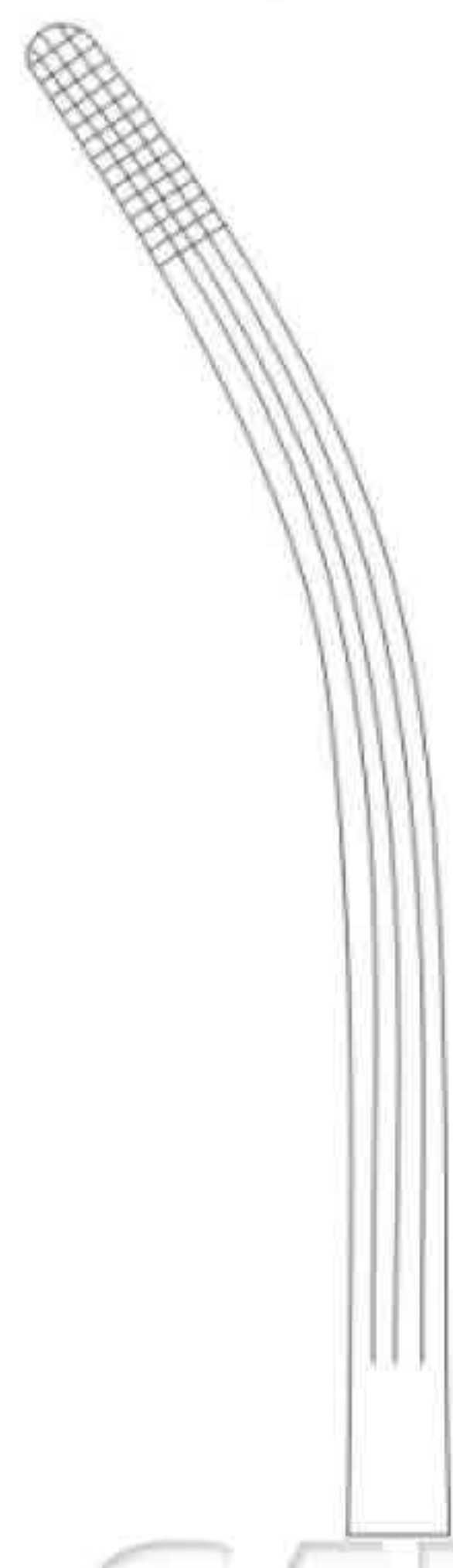
SSC -11-15-63
16.0 cm / 6 1/4"



SSC -11-15-64
20.0 cm / 8"



SSC -11-15-65
16.0 cm / 6 1/4"



SSC -11-15-66
20.0 cm / 8"



Pean
Delicate Pattern

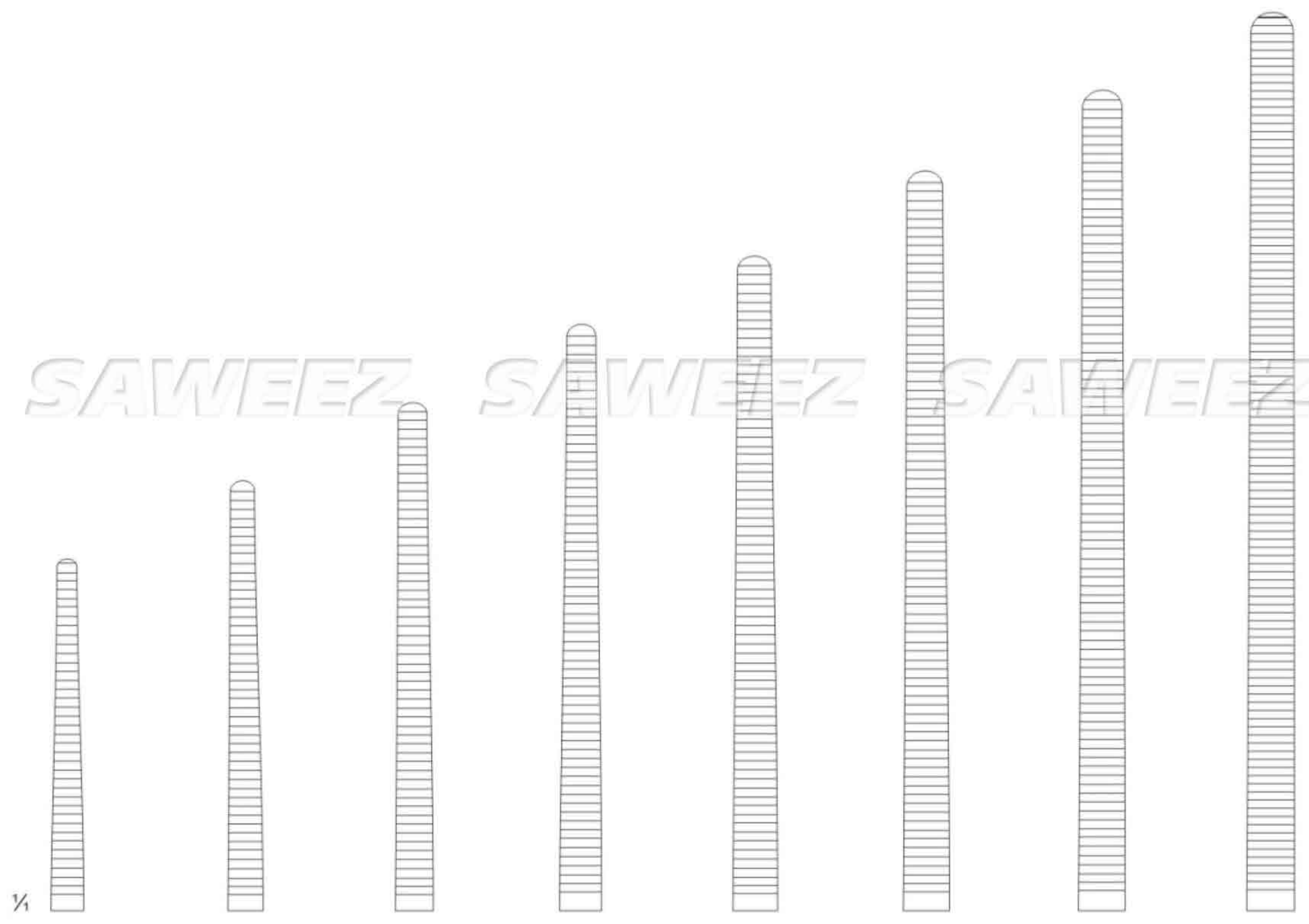
SSC-11-15-67 13.0 cm / 5"	SSC-11-15-68 14.0 cm / 5½"	SSC-11-15-69 16.0 cm / 6¼"	SSC-11-15-70 13.0 cm / 5"	SSC-11-15-71 14.0 cm / 5½"	SSC-11-15-72 16.0 cm / 6¼"



Kocher
Delicate Pattern

SSC-11-15-73 13.0 cm / 5"	SSC-11-15-74 14.0 cm / 5½"	SSC-11-15-75 16.0 cm / 6¼"	SSC-11-15-76 13.0 cm / 5"	SSC-11-15-77 14.0 cm / 5½"	SSC-11-15-78 16.0 cm / 6¼"

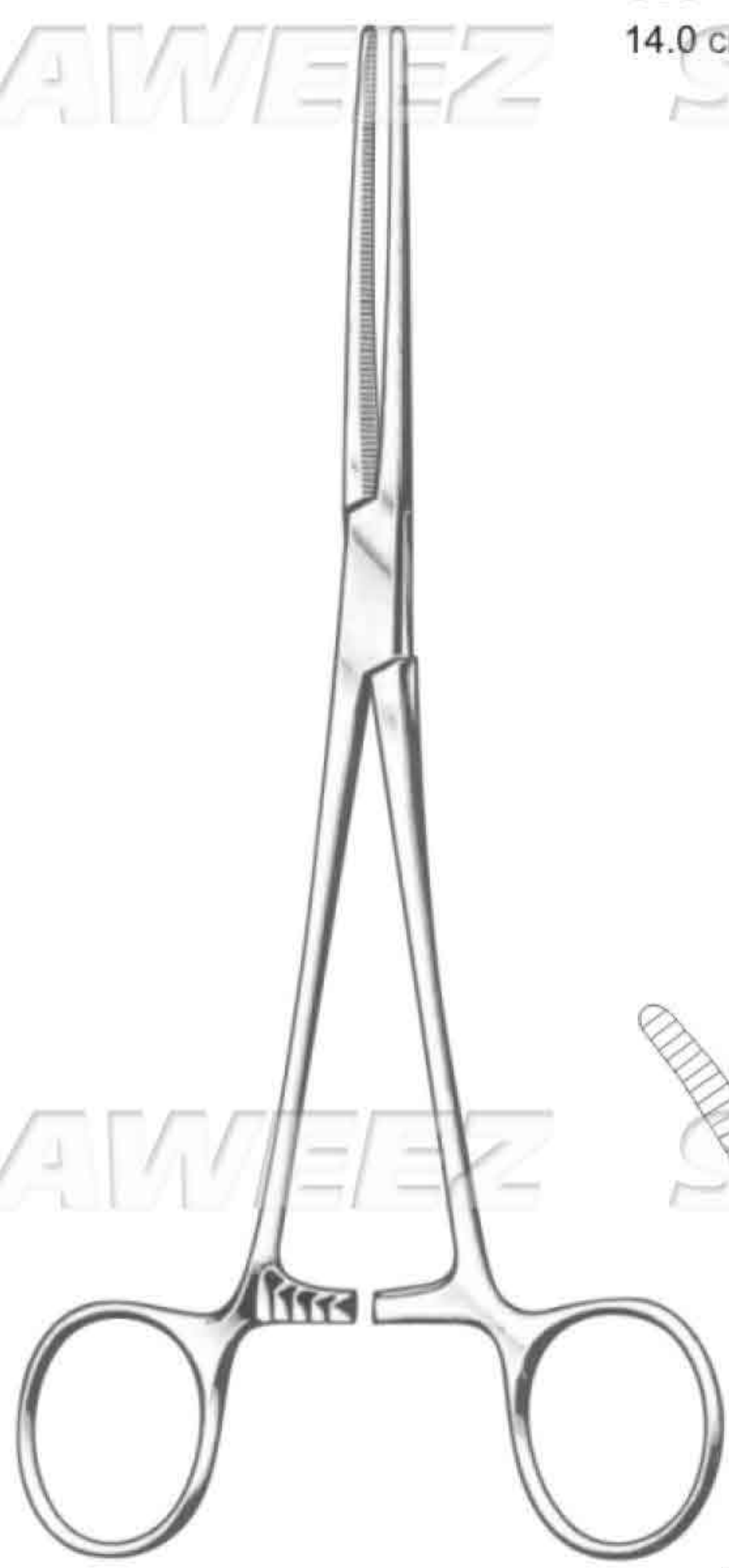
SAWEEZ SAWEEZ SAWEEZ SAWEEZ



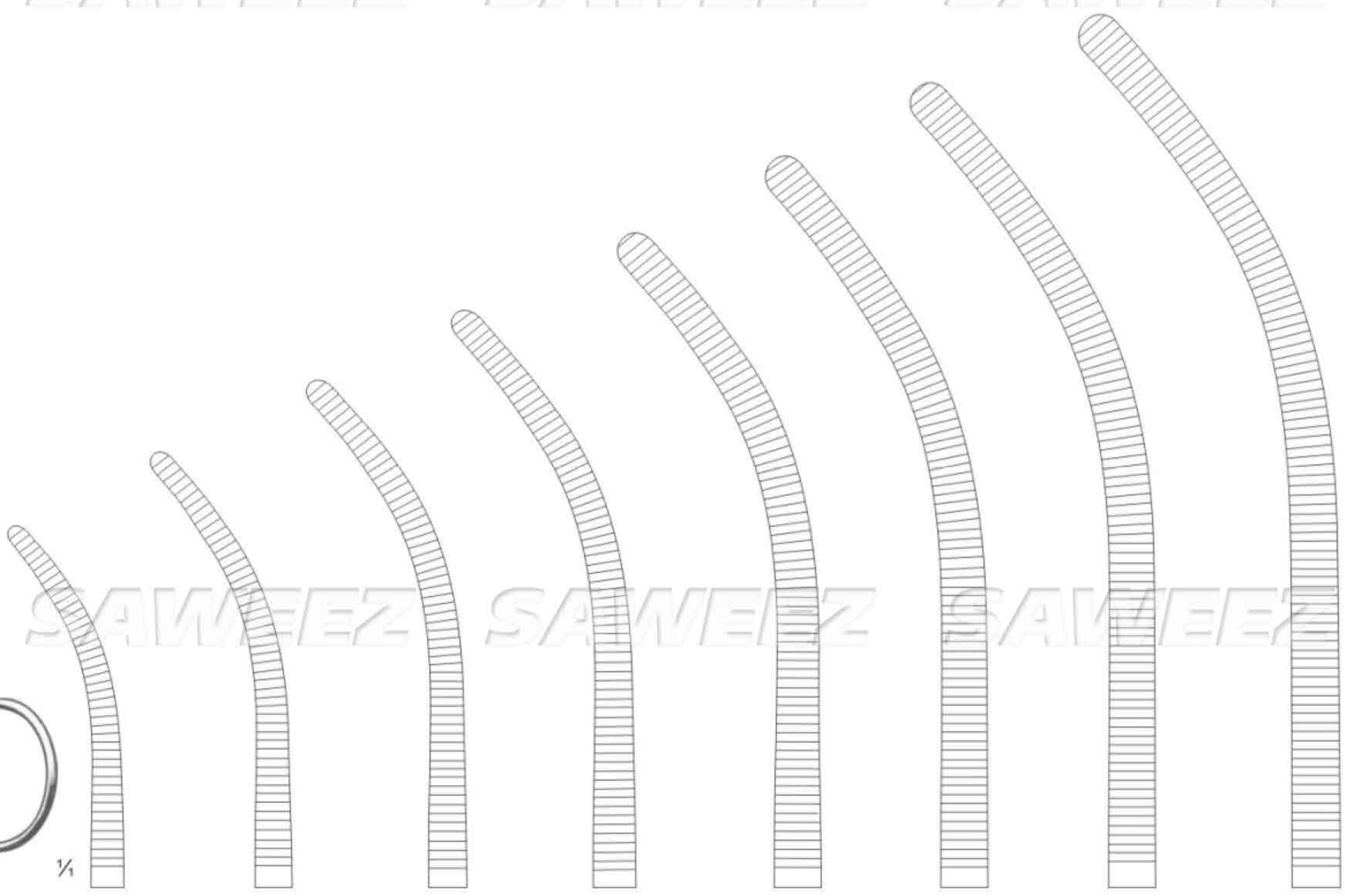
SSC-11-15-79 14.0 cm / 5 1/2" SSC-11-15-80 16.0 cm / 6 1/4" SSC-11-15-81 18.0 cm / 7" SSC-11-15-82 20.0 cm / 8" SSC-11-15-83 22.0 cm / 8 3/4" SSC-11-15-84 24.0 cm / 9 1/2" SSC-11-15-85 26.0 cm / 10 1/4" SSC-11-15-86 30.0 cm / 12"

SAWEEZ

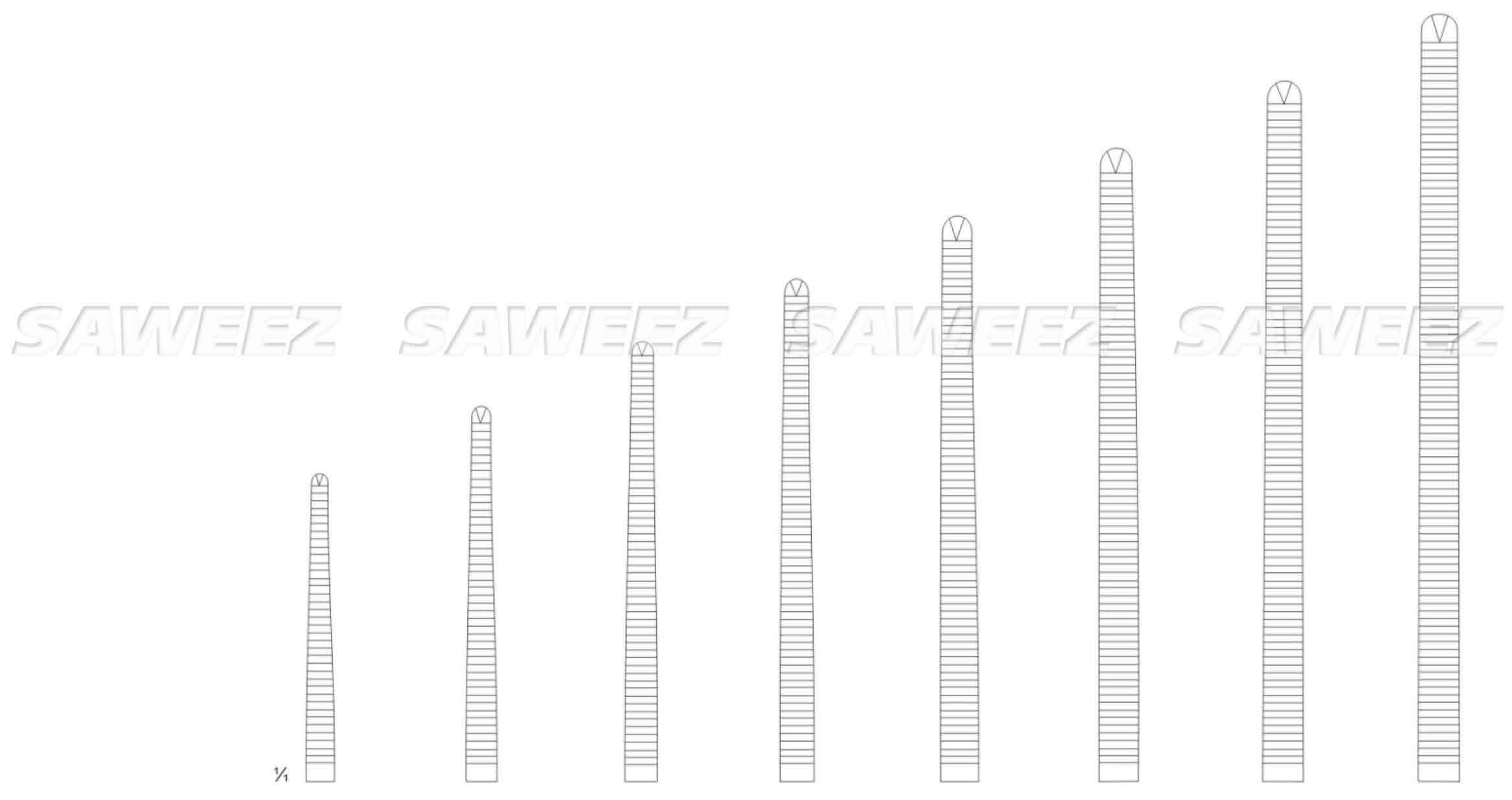
SAWEEZ SAWEEZ SAWEEZ SAWEEZ



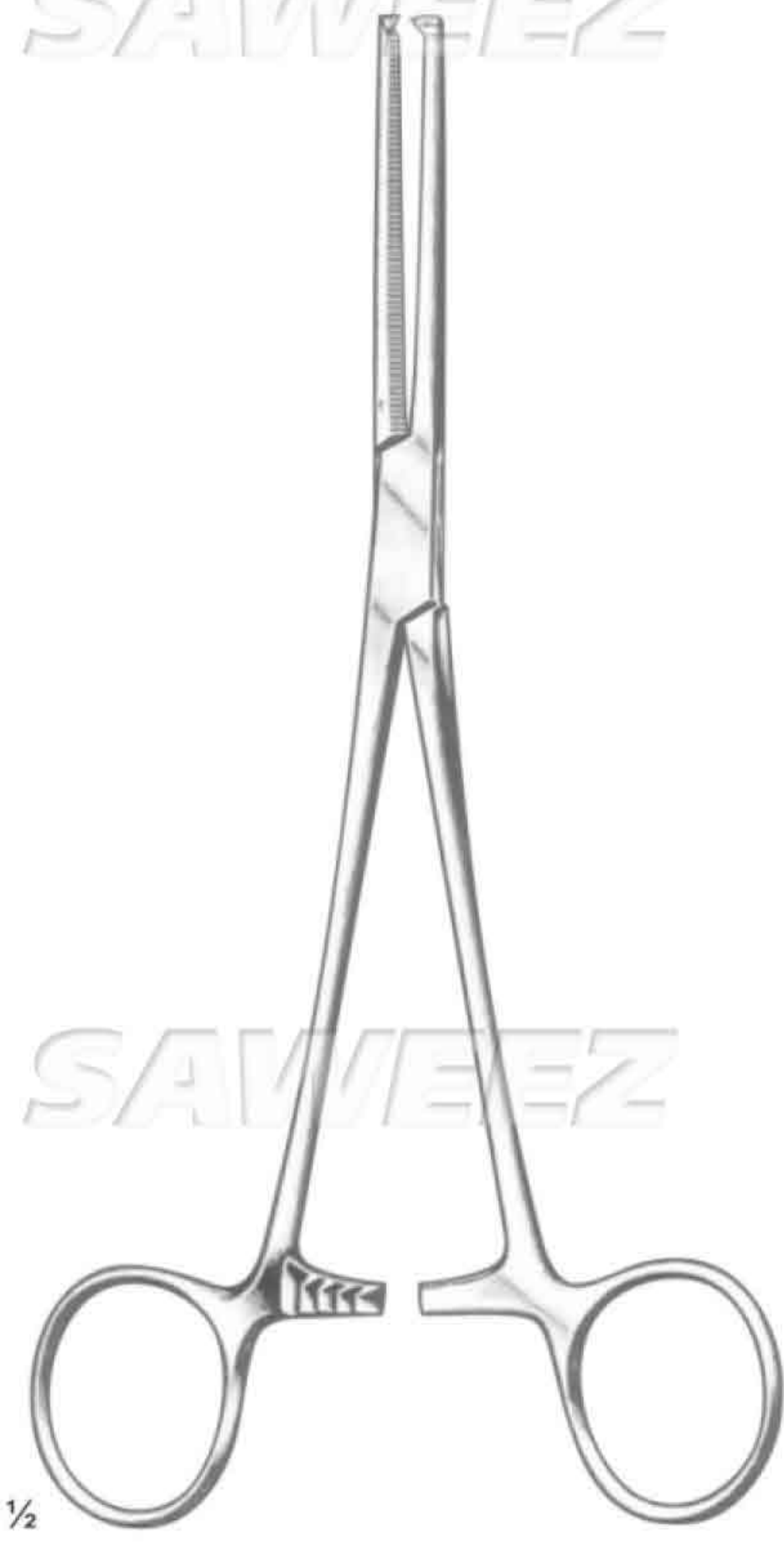
Rochester-Pean



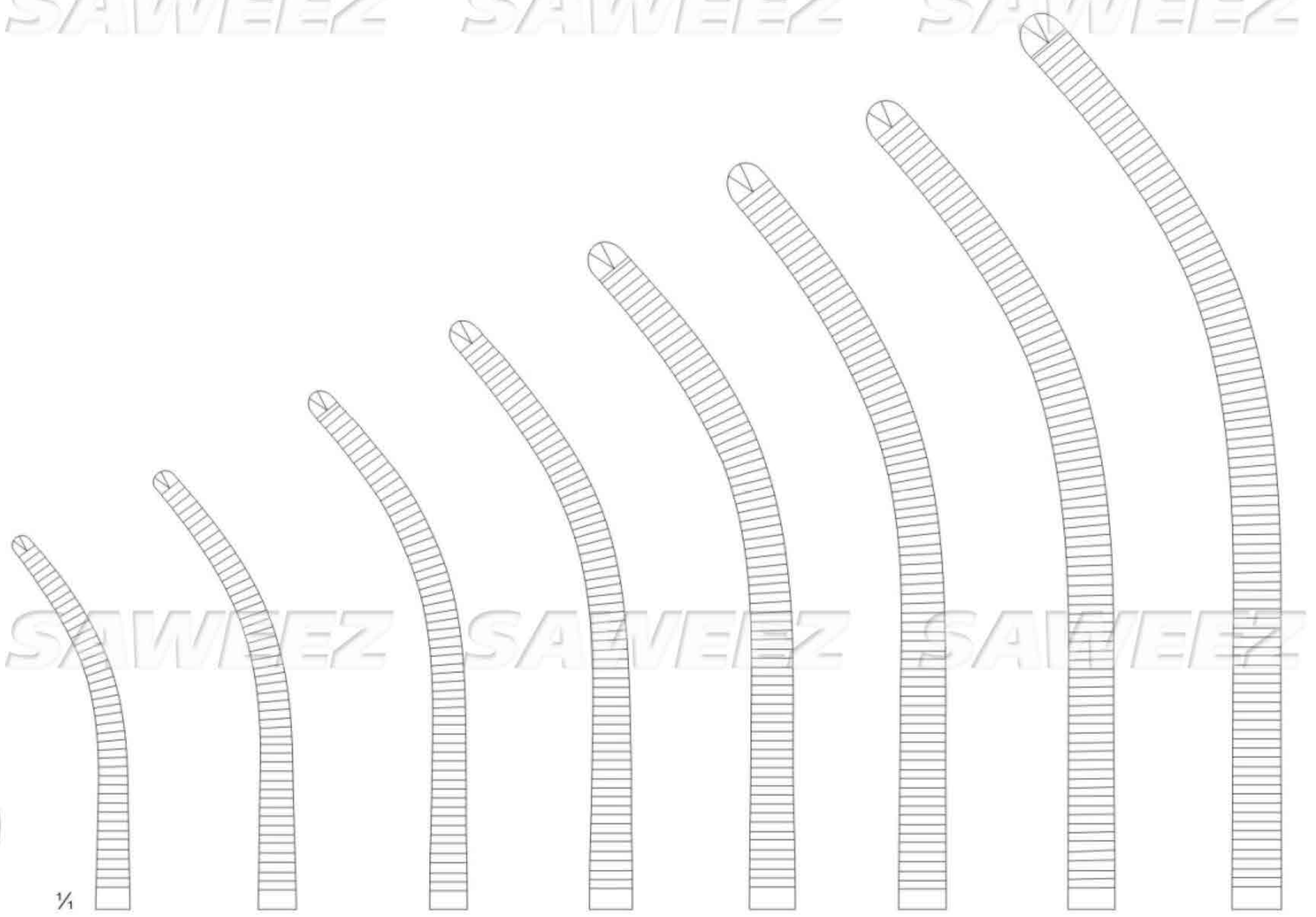
SSC-11-15-87 14.0 cm / 5 1/2" SSC-11-15-88 16.0 cm / 6 1/4" SSC-11-15-89 18.0 cm / 7" SSC-11-15-90 20.0 cm / 8" SSC-11-15-91 22.0 cm / 8 3/4" SSC-11-15-92 24.0 cm / 9 1/2" SSC-11-15-93 26.0 cm / 10 1/4" SSC-11-15-94 30.0 cm / 12"



SSC -11-15-95 14.0 cm / 5½" SSC -11-15-96 16.0 cm / 6¼" SSC -11-15-97 18.0 cm / 7" SSC -11-15-98 20.0 cm / 8" SSC -11-15-99 22.0 cm / 8¾" SSC -11-16-00 24.0 cm / 9½" SSC -11-16-01 26.0 cm / 10¼" SSC -11-16-02 30.0 cm / 12"



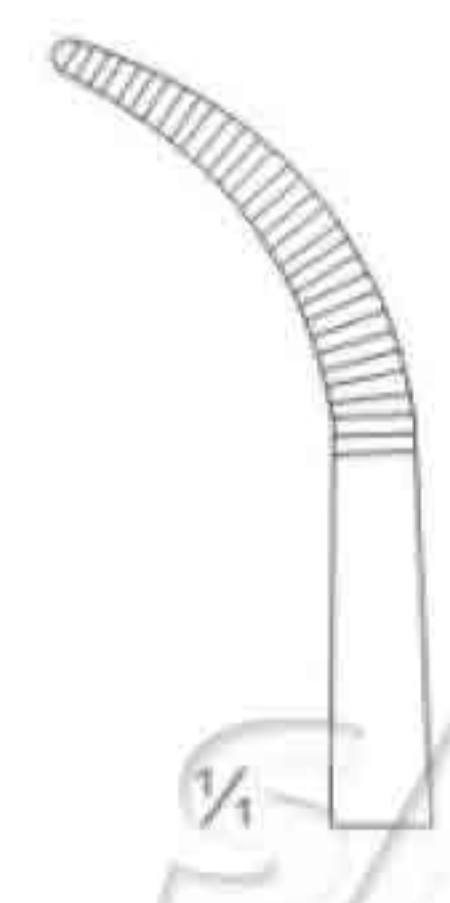
Kocher (Ochsner)
1x2 Teeth



SSC -11-16-03 14.0 cm / 5½" SSC -11-16-04 16.0 cm / 6¼" SSC -11-16-05 18.0 cm / 7" SSC -11-16-06 20.0 cm / 8" SSC -11-16-07 22.0 cm / 8¾" SSC -11-16-08 24.0 cm / 9½" SSC -11-16-09 26.0 cm / 10¼" SSC -11-16-10 30.0 cm / 12"



Baby-Mixer



SSC-11-16-11
18.0 cm / 7"



Baby-Adson



SSC-11-16-12
14.0 cm / 5 1/2"



SSC-11-16-13
18.0 cm / 7"



Heiss



SSC-11-16-14
20.0 cm / 8"



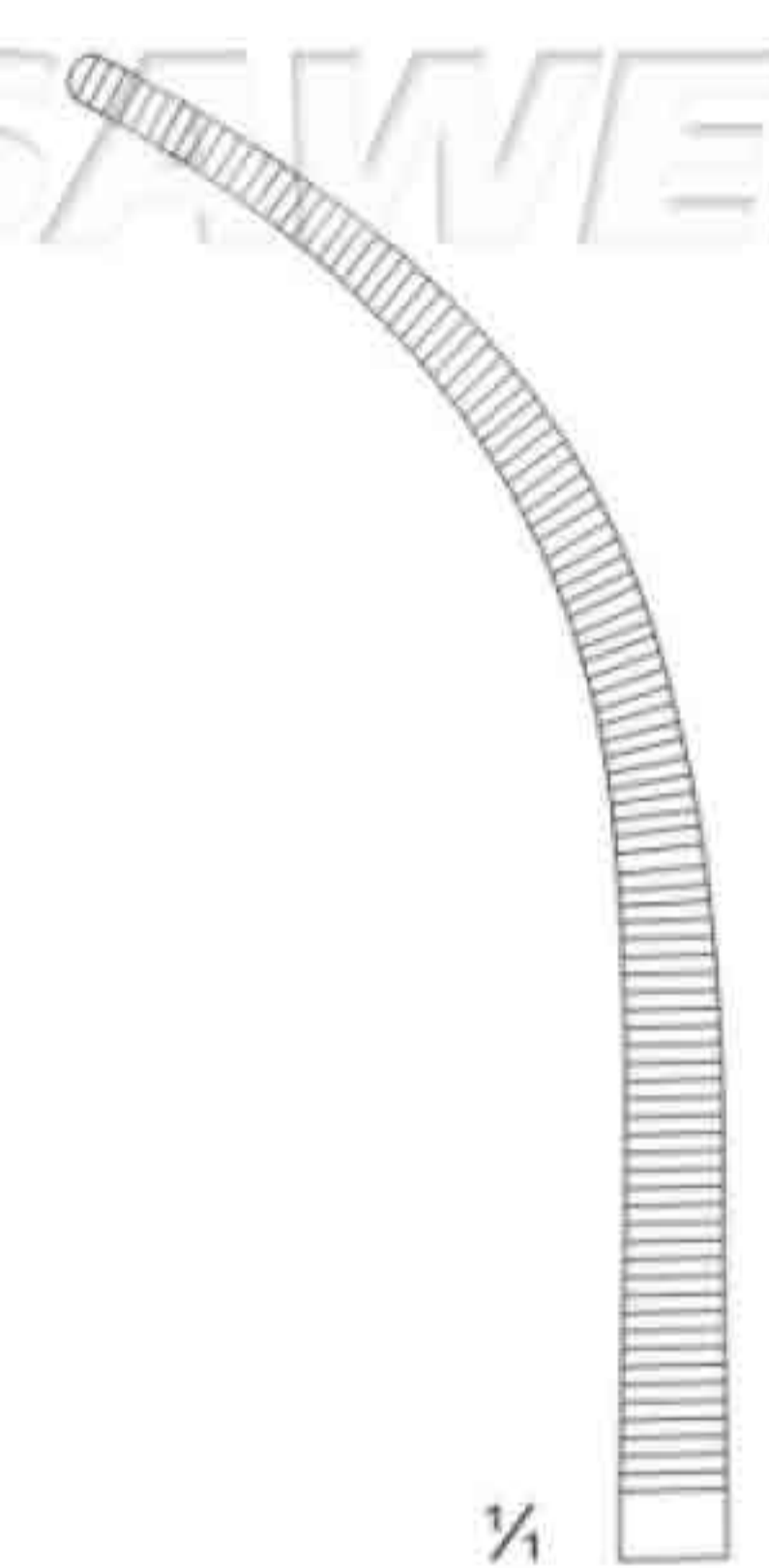
SSC-11-16-15
20.0 cm / 8"



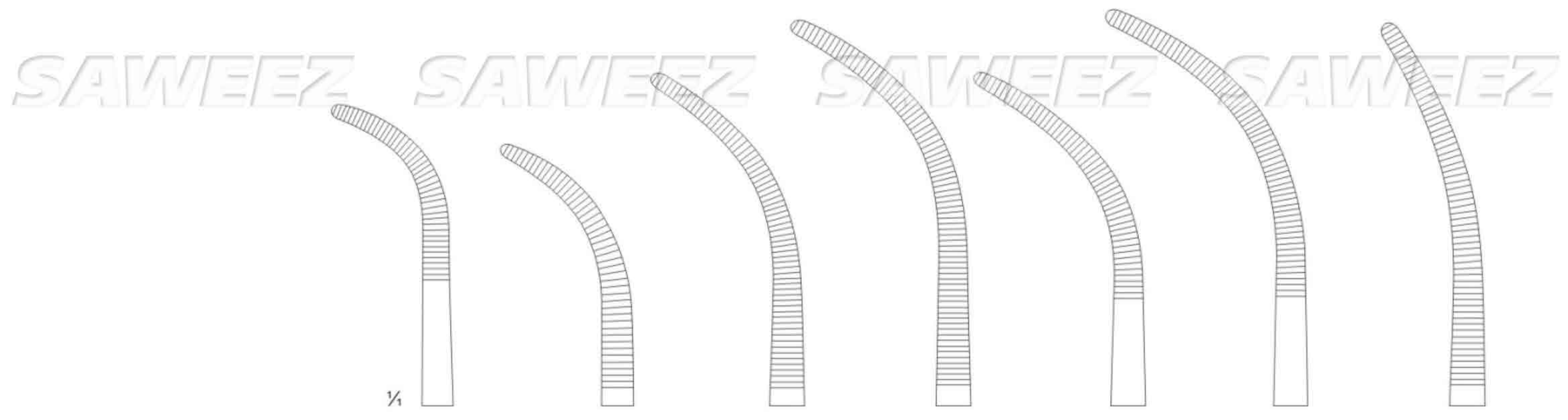
SSC-11-16-16
20.0 cm / 8"



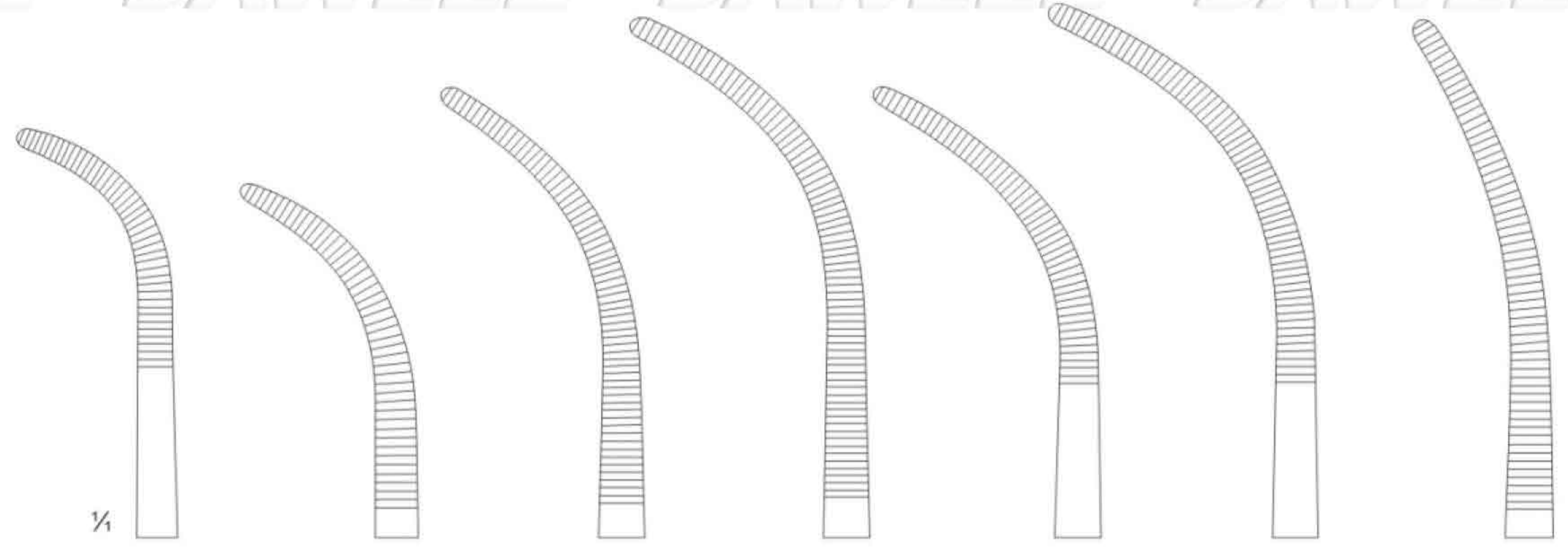
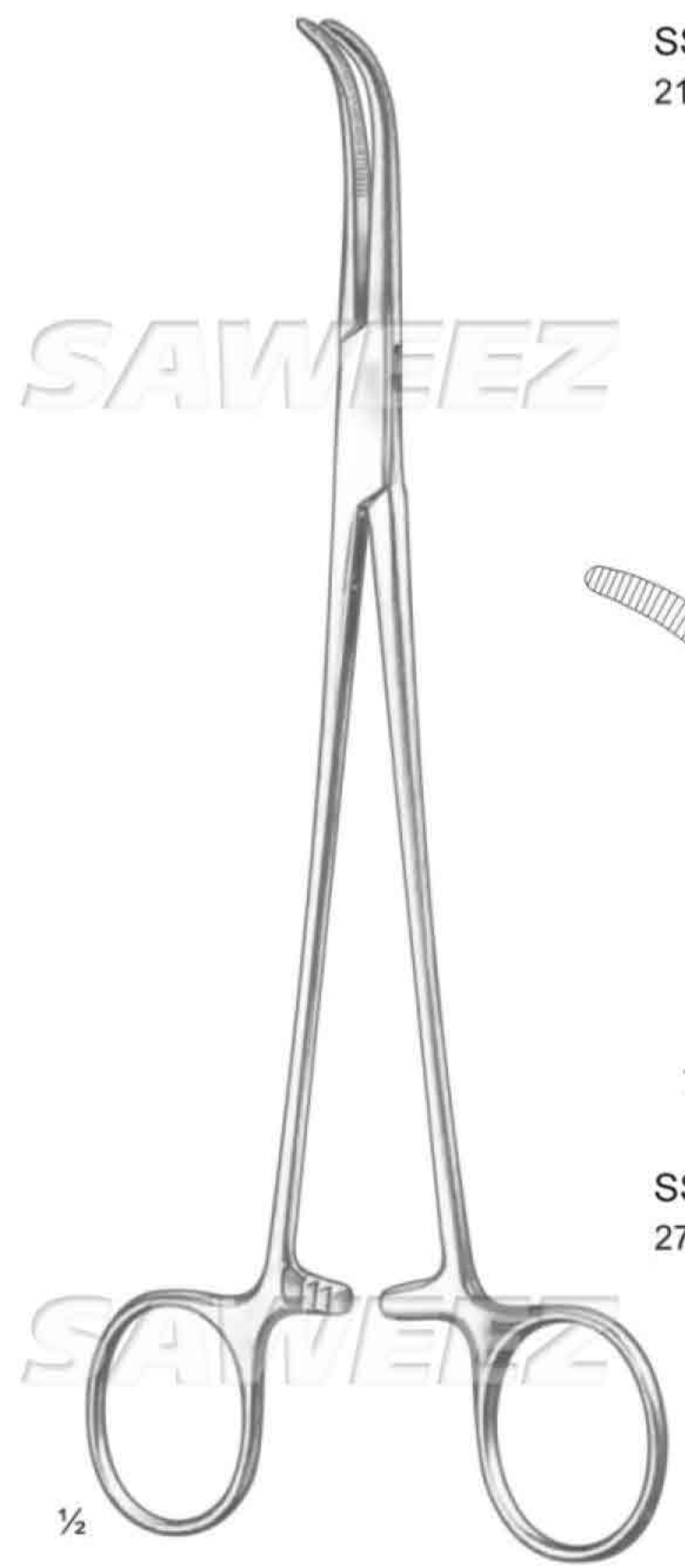
Overholt-Mixer



SSC-11-16-17
21.0 cm / 8 1/4"



SSC-11-16-18	SSC-11-16-19	SSC-11-16-20	SSC-11-16-21	SSC-11-16-22	SSC-11-16-23	SSC-11-16-24
21.0 cm / 8 1/4"	21.0 cm / 8 1/4"	21.0 cm / 8 1/4"	21.0 cm / 8 1/4"	21.0 cm / 8 1/4"	21.0 cm / 8 1/4"	21.0 cm / 8 1/4"



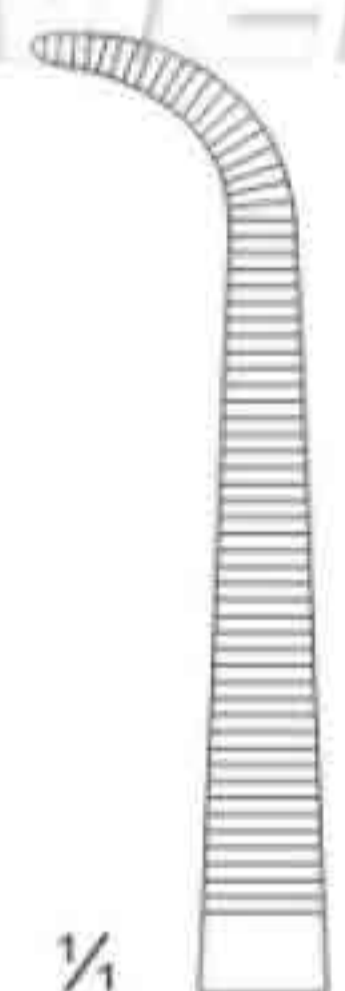
SSC-11-16-25	SSC-11-16-26	SSC-11-16-27	SSC-11-16-28	SSC-11-16-29	SSC-11-16-30	SSC-11-16-31
27.0 cm / 10 3/4"	27.0 cm / 10 3/4"	27.0 cm / 10 3/4"	27.0 cm / 10 3/4"	27.0 cm / 10 3/4"	27.0 cm / 10 3/4"	27.0 cm / 10 3/4"

Overholt-Geissendoerfer

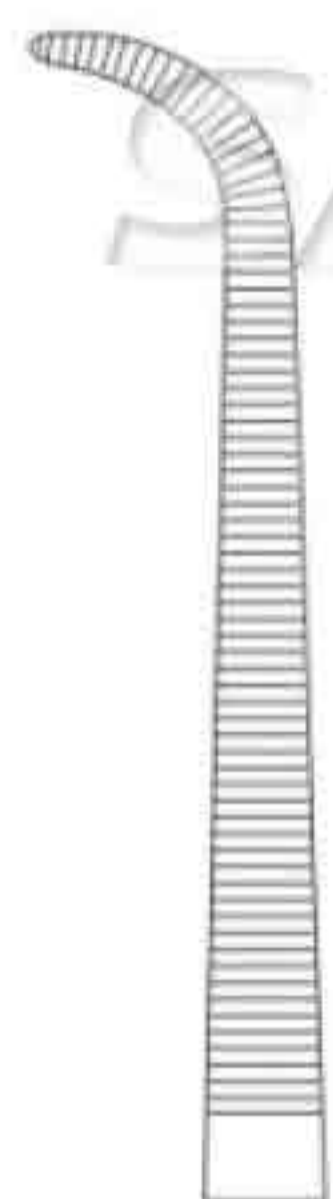


1/2

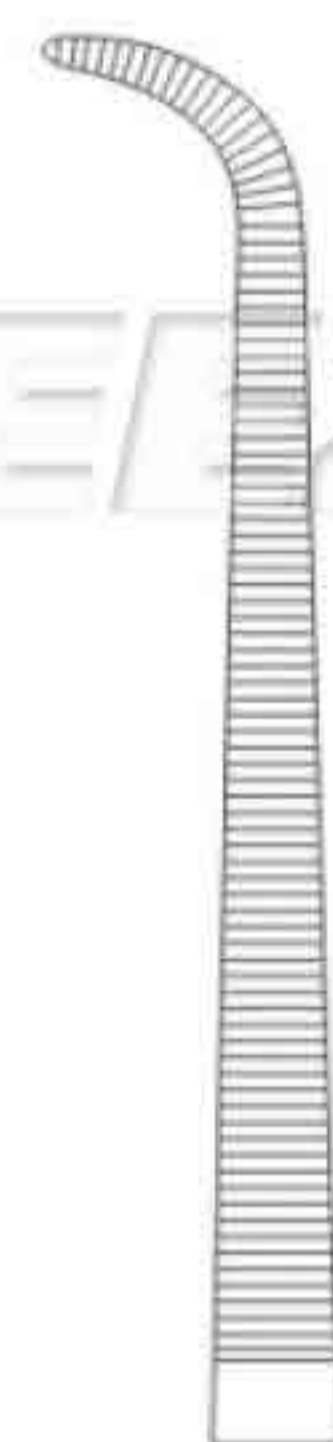
Mini-Gemini



SSC -11-16-32
18.0 cm / 7"



SSC -11-16-33
22.0 cm / 8 3/4"



SSC -11-16-34
25.0 cm / 10"

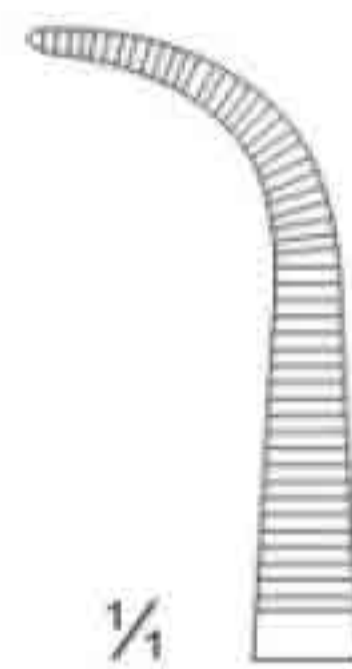


SSC -11-16-35
28.0 cm / 11"

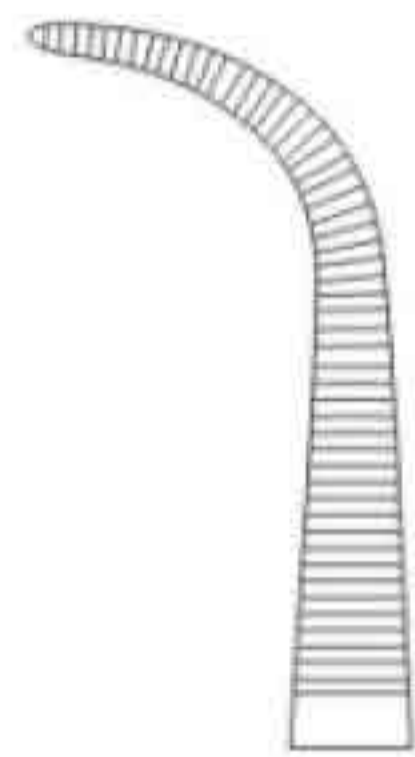


1/2

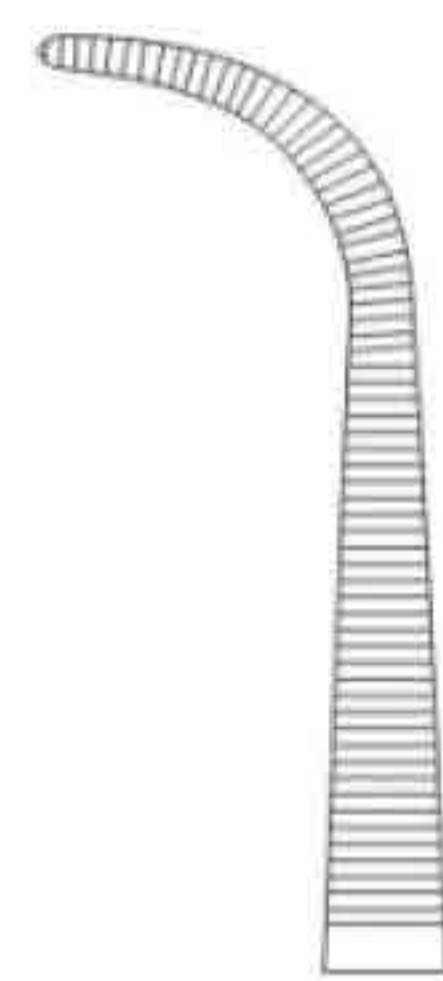
Gemini



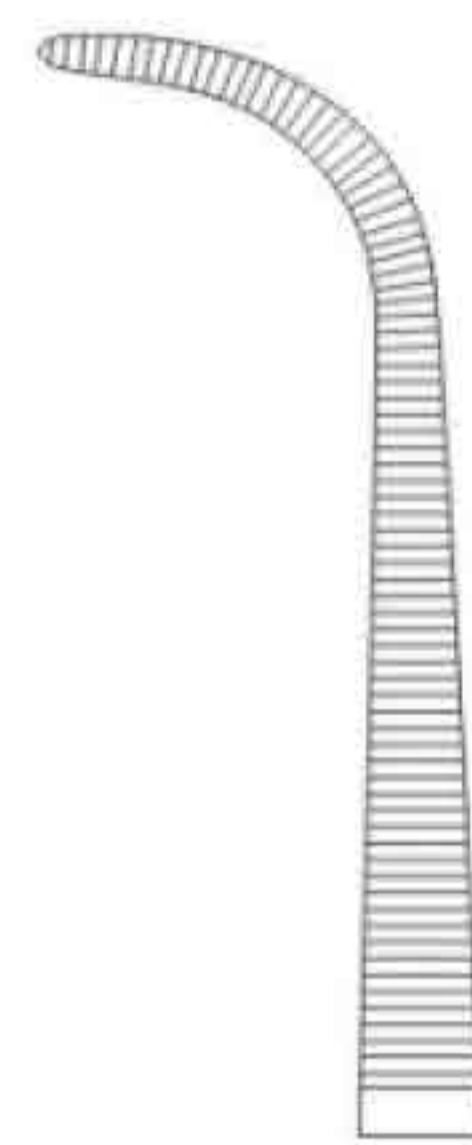
SSC -11-16-36
13.0 cm / 5"



SSC -11-16-37
16.0 cm / 6 1/4"



SSC -11-16-38
18.0 cm / 7"



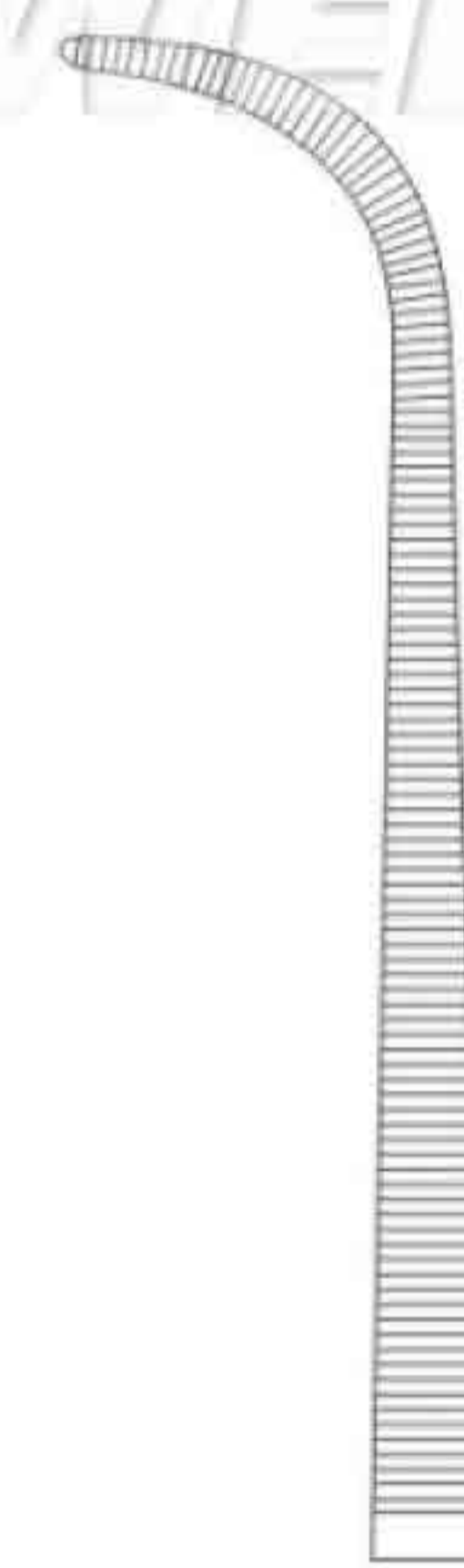
SSC -11-16-39
20.0 cm / 8"



SSC -11-16-40
23.0 cm / 9"



SSC -11-16-41
25.0 cm / 10"



SSC -11-16-42
28.0 cm / 11"



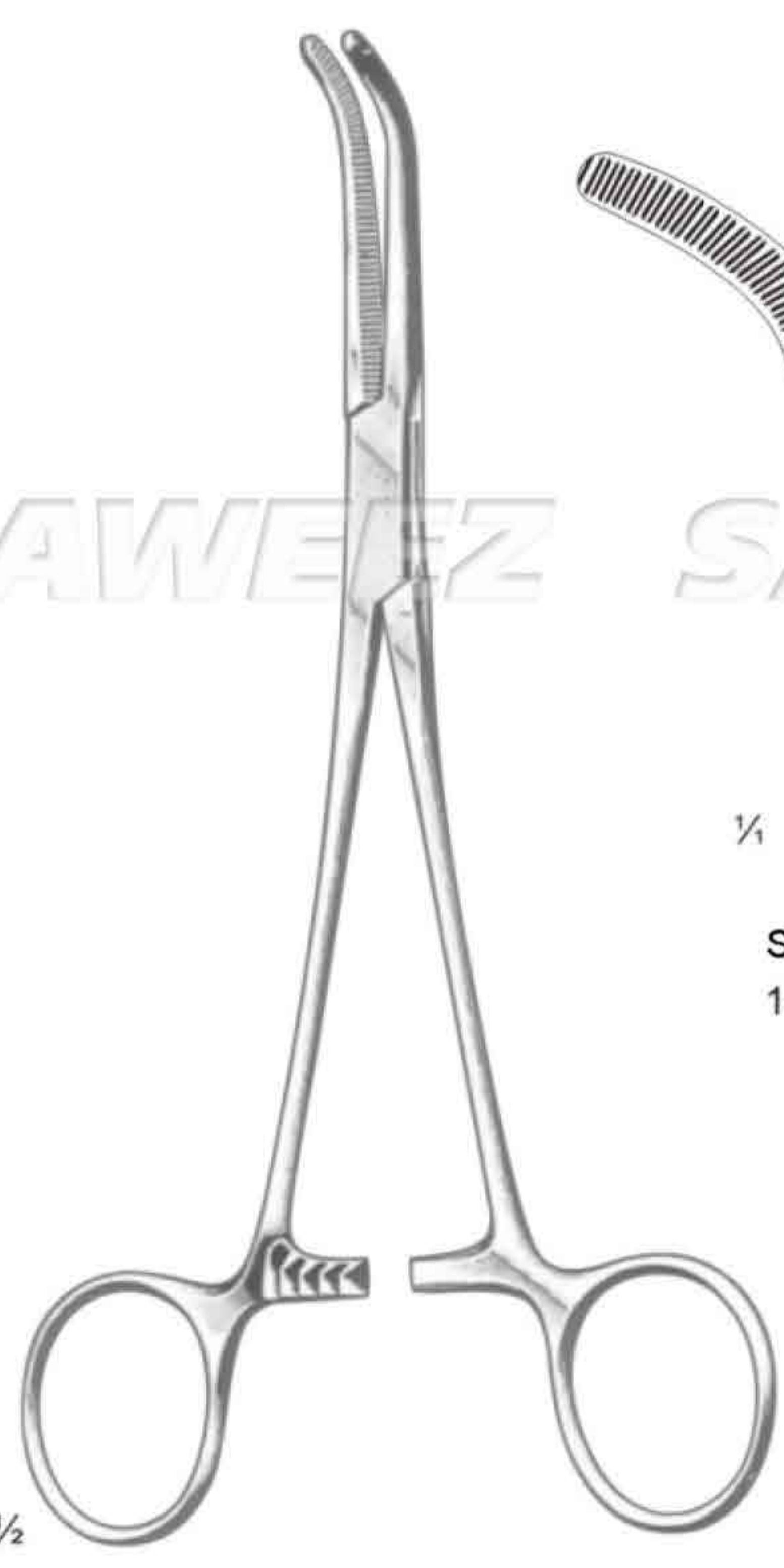
Mixer



SSC -11-16-43
15.0 cm / 6"



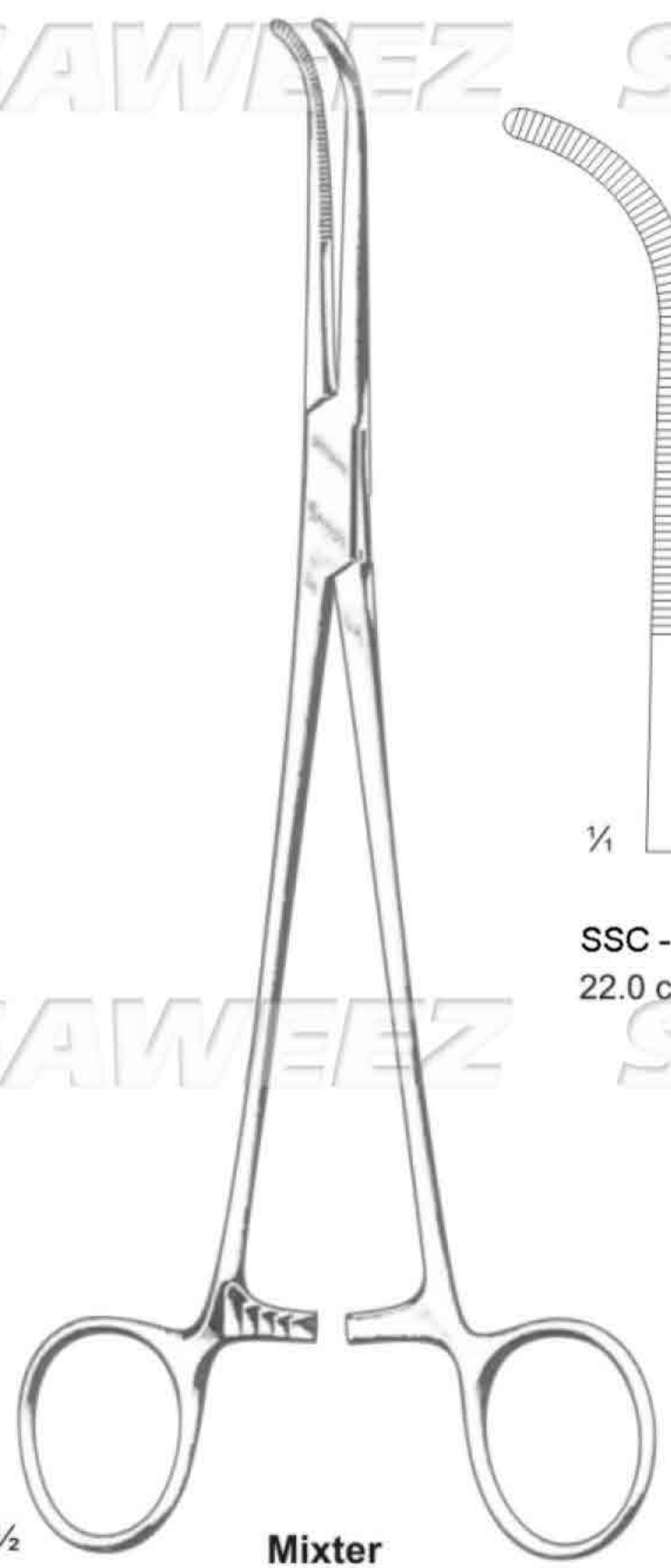
SSC -11-16-44
18.0 cm / 7"



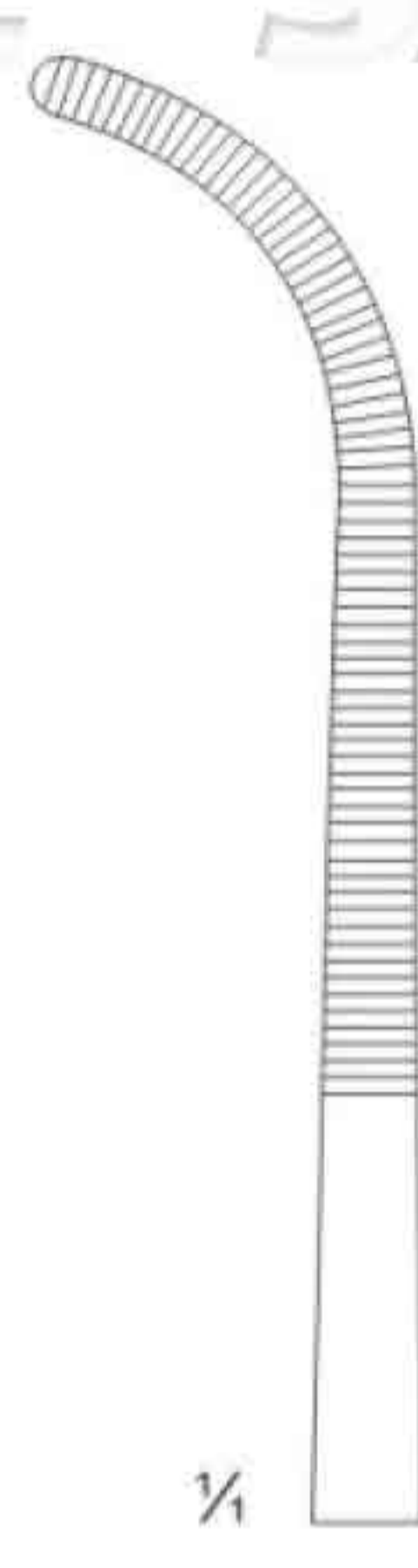
Mixer-O'Shaugnessy



SSC -11-16-45
18.0 cm / 7"



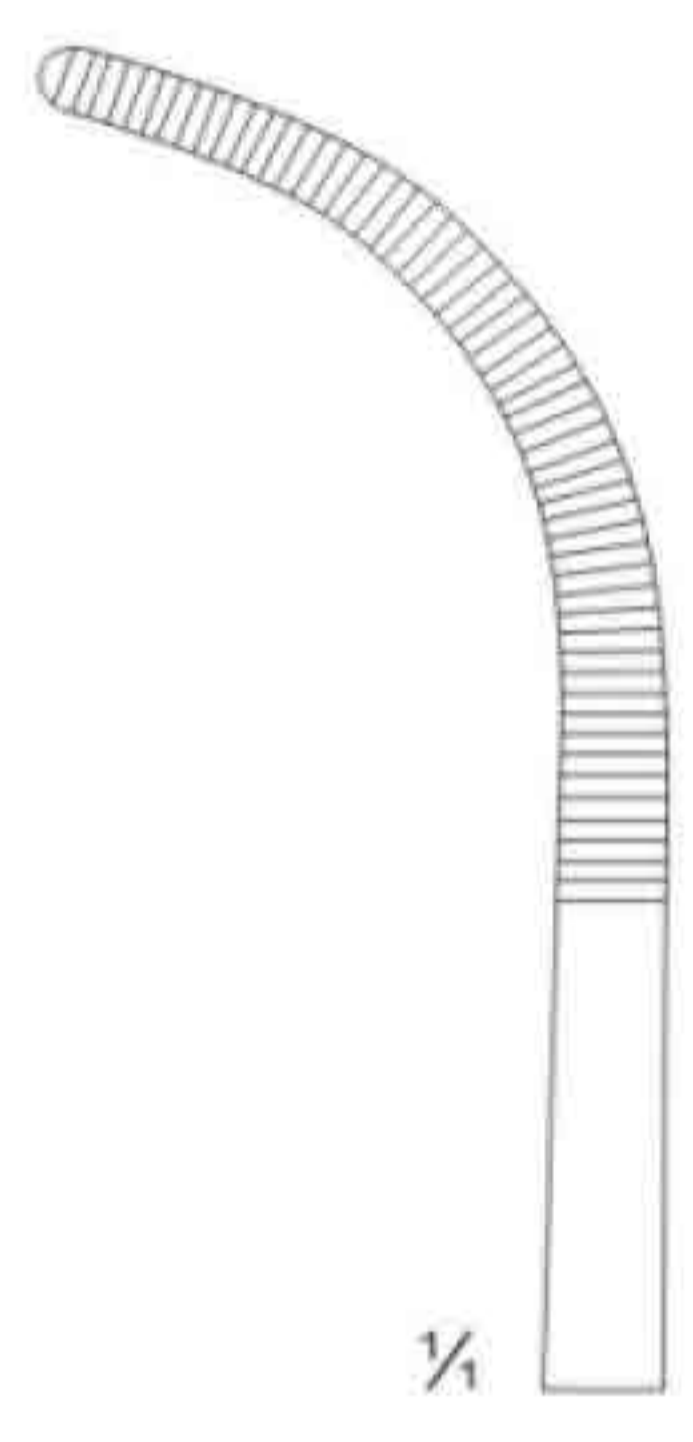
Mixer



SSC -11-16-46
22.0 cm / 8 3/4"



Mixer



SSC -11-16-47
23.0 cm / 9"

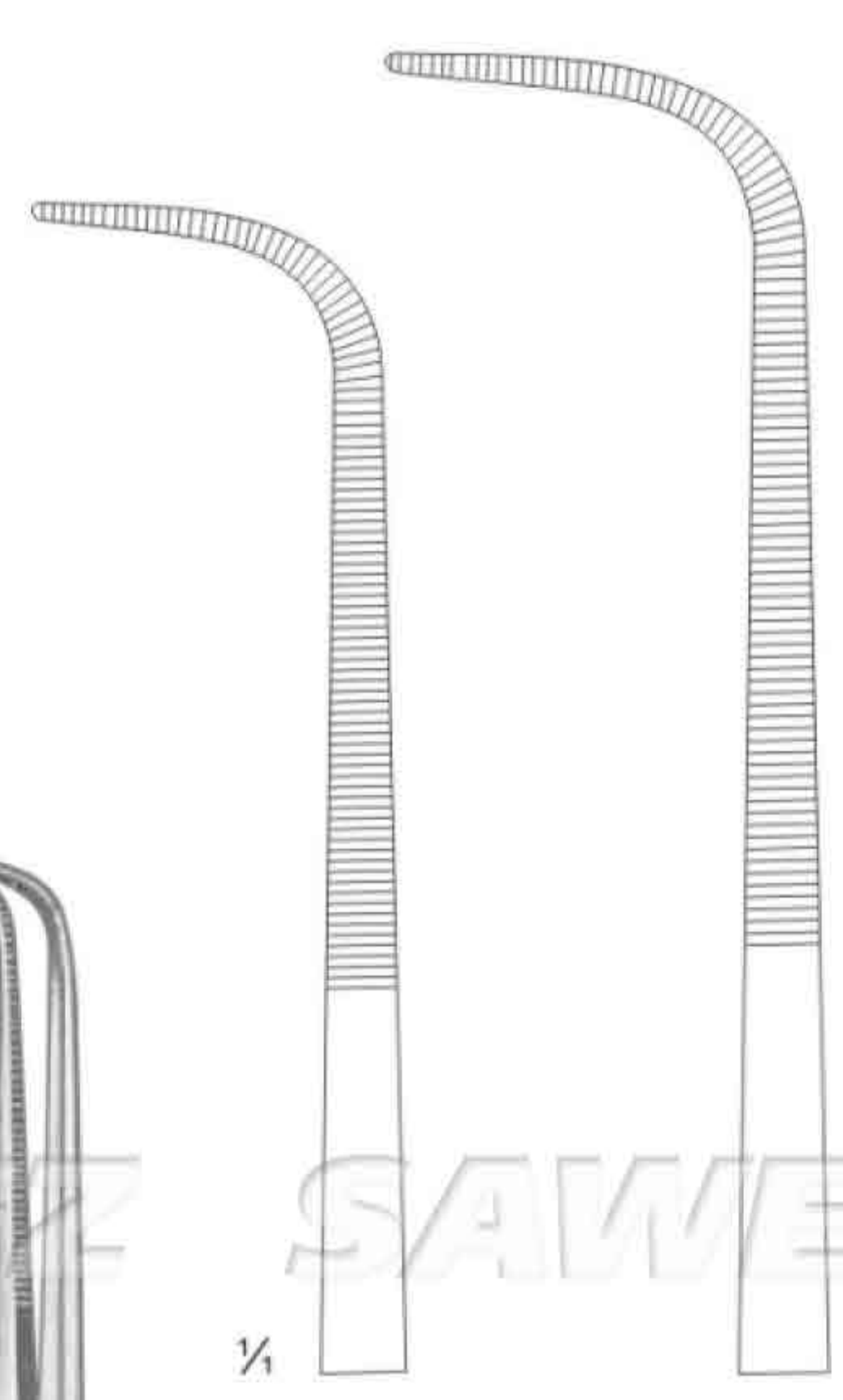


SAWEEZ SAWEEZ SAWEEZ SAWEEZ



1/2

Wickstrom



1/4

SSC-11-16-48
21.0 cm / 8"

SSC-11-16-49
24.0 cm / 9 1/4"



1/2

Mixer

1/4

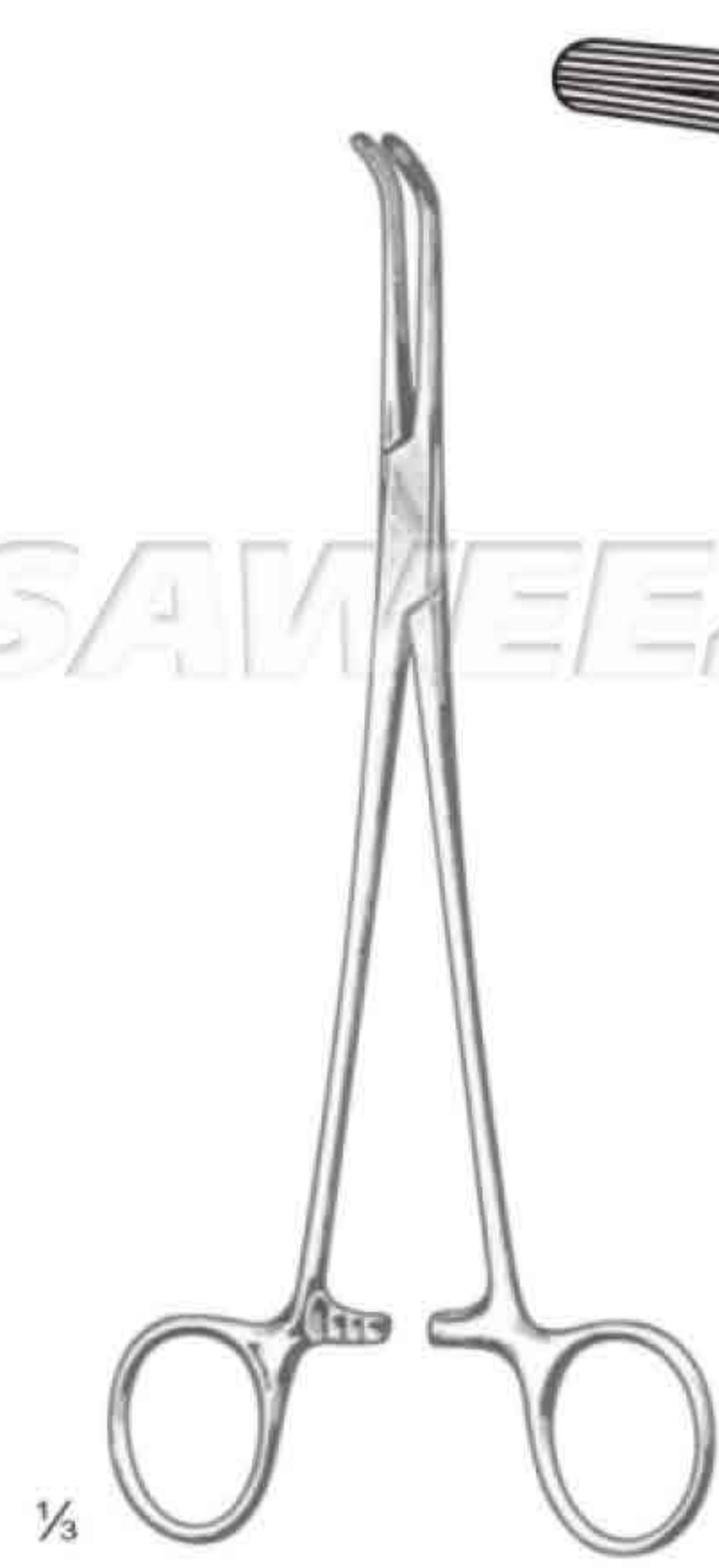
SSC-11-16-50
22.0 cm / 8 3/4"

SSC-11-16-51
25.0 cm / 10"

SSC-11-16-52
28.0 cm / 11"

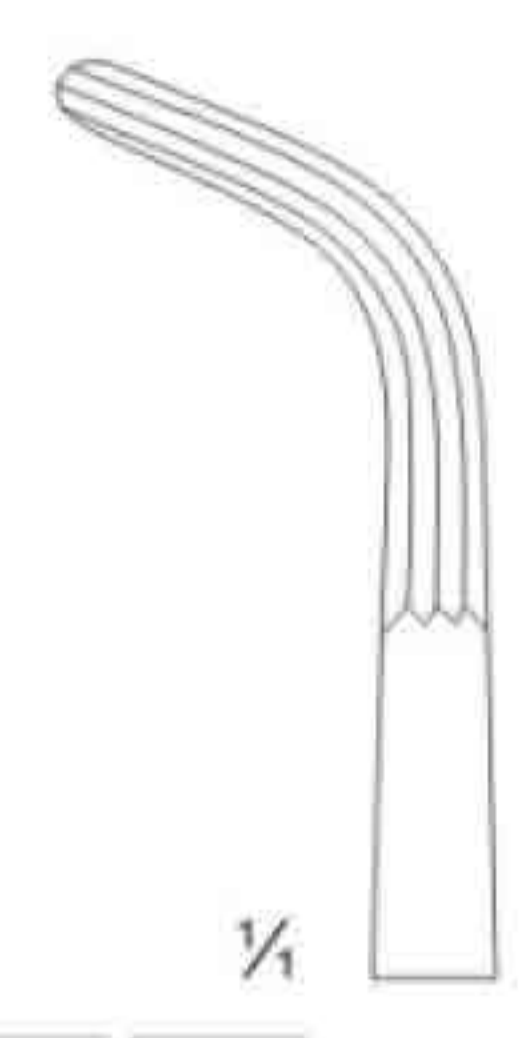
SAWEEZ SAWEEZ SAWEEZ SAWEEZ

SAWEEZ SAWEEZ SAWEEZ SAWEEZ



SSC -11-16-53
22.0 cm / 8 3/4"

Mcquigg-Mixer

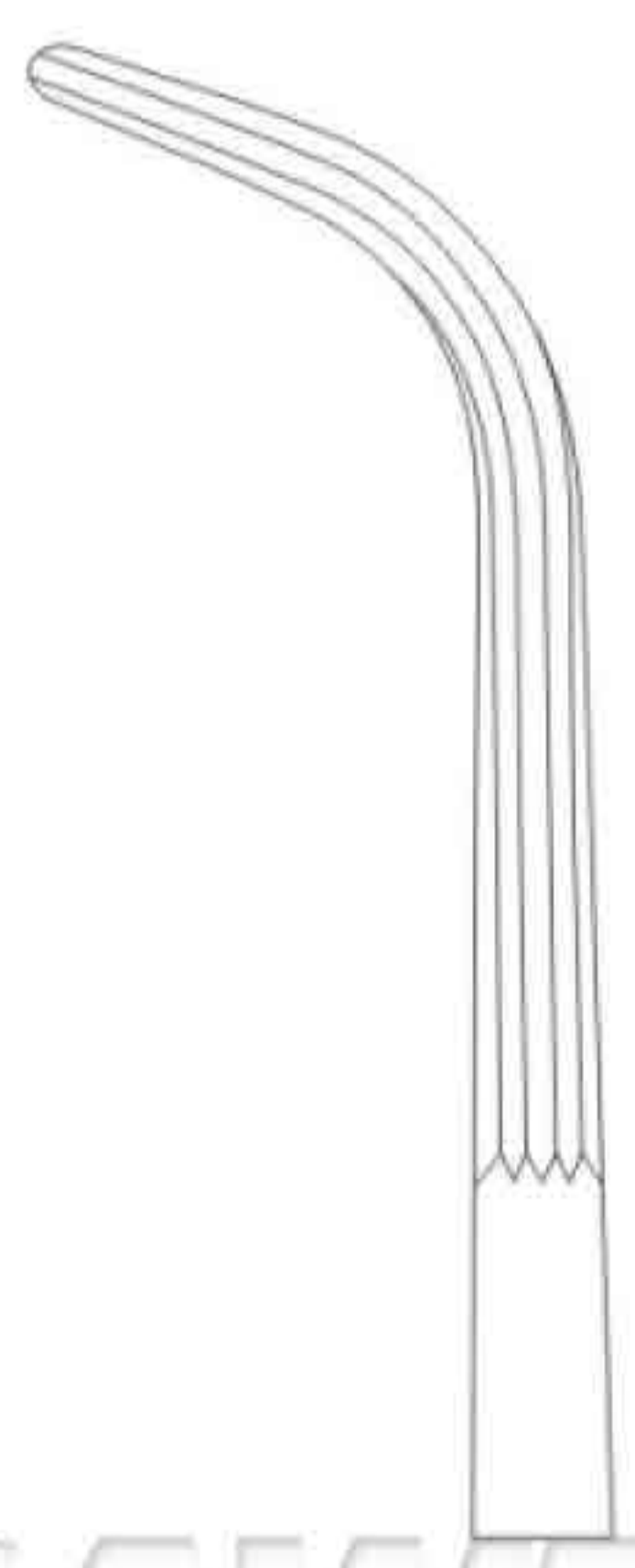


SSC -11-16-54
18.0 cm / 7"

Lower

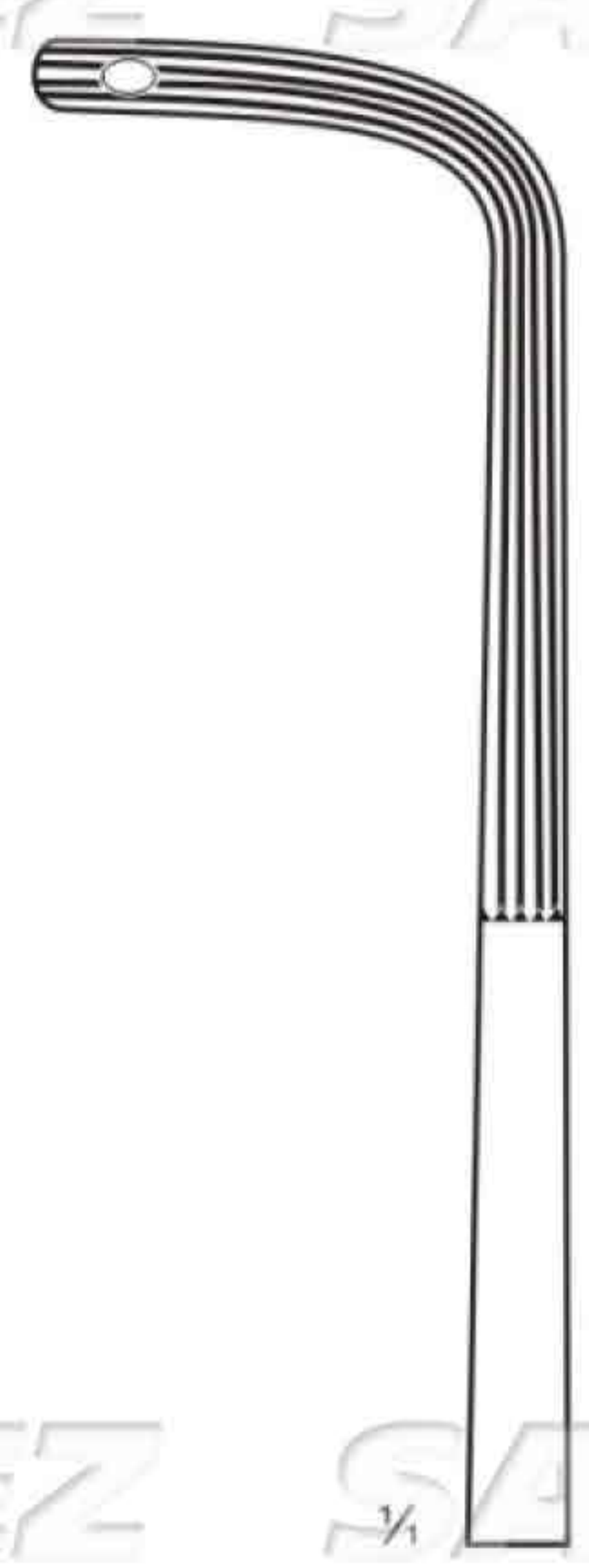


SSC -11-16-55
19.0 cm / 7 1/2"



SSC -11-16-56
23.0 cm / 9"

Lahey



SSC -11-16-57
24.0 cm / 9 1/2"

Finocchetto



SAWEEZ SAWEEZ SAWEEZ SAWEEZ



1/3

Guyon



1/4

SSC -11-16-58
23.0 cm / 9"



SSC -11-16-59
24.0 cm / 9 1/2"

SAWEEZ SAWEEZ SAWEEZ SAWEEZ

SAWEEZ SAWEEZ SAWEEZ SAWEEZ



SAWEEZ SAWEEZ SAWEEZ SAWEEZ



SSC -11-16-60
20.0 cm / 8"

SSC -11-16-61
22.0 cm / 8¾"

SSC -11-16-62
24.0 cm / 8½"

SSC -11-16-63
23.0 cm / 9"

Guyon

Guyon



SAWEEZ SAWEEZ SAWEEZ SAWEEZ



SSC -11-16-64
21.0 cm / 8¼"

Desjardins

SAWEEZ SAWEEZ SAWEEZ SAWEEZ

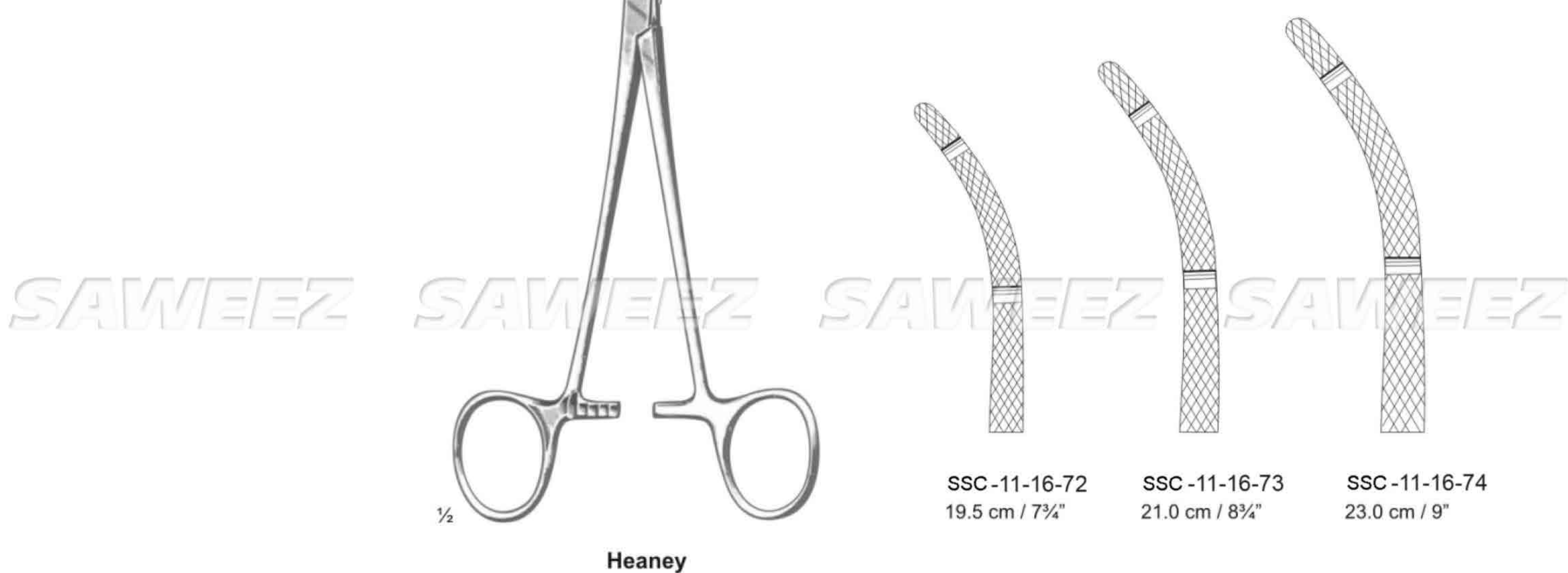
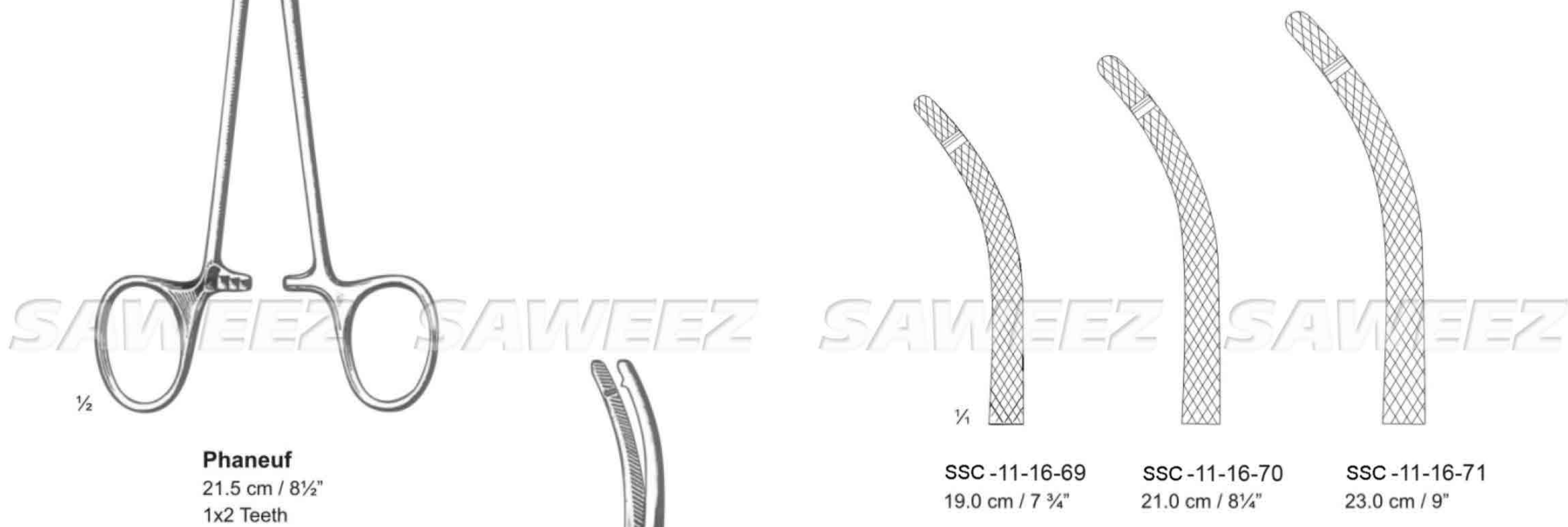


SSC -11-16-65
19.0 cm / 7½"

SSC -11-16-66
19.0 cm / 7½"

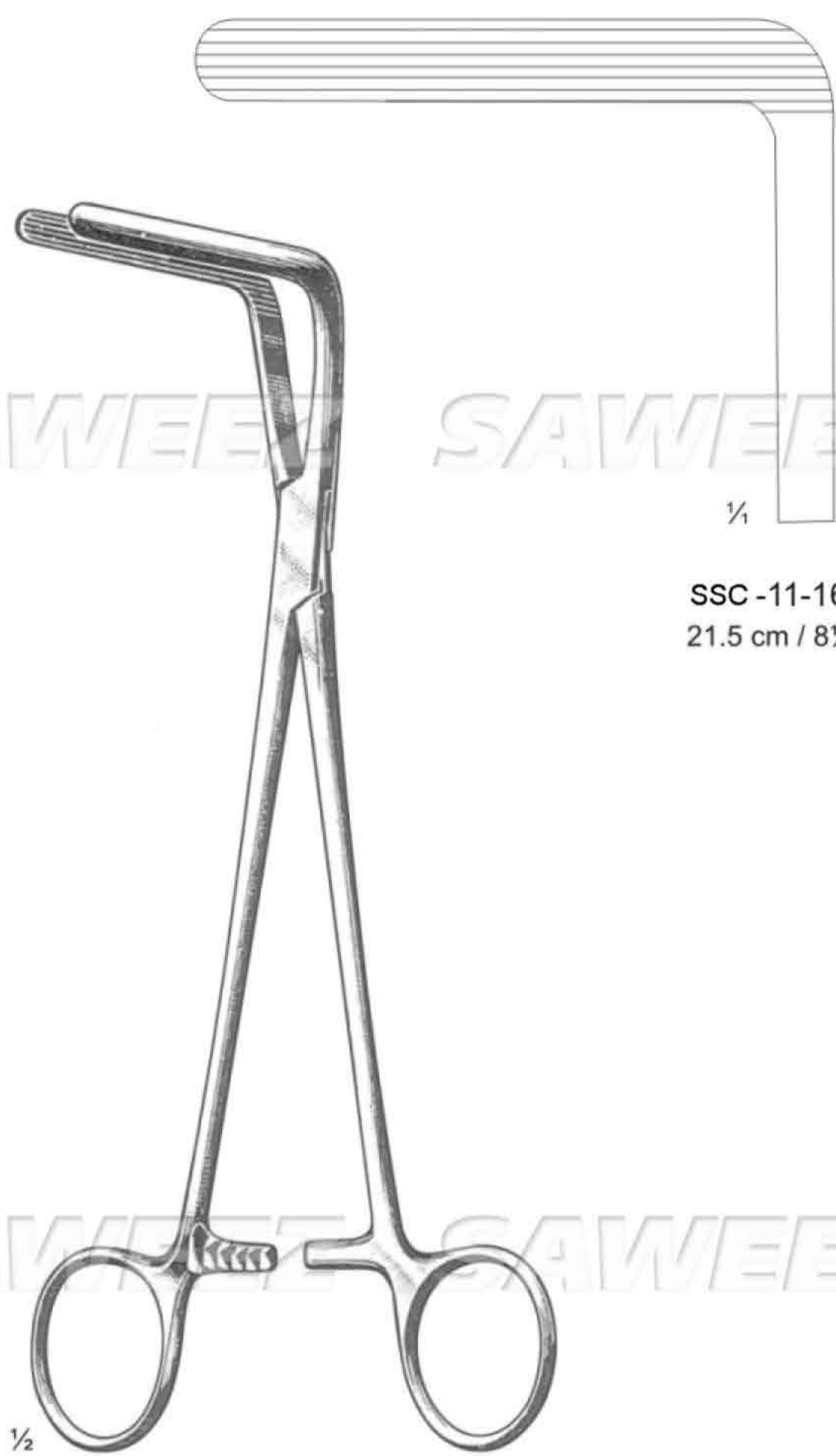
Negus

SAWEEZ SAWEEZ SAWEEZ SAWEEZ





SAWEEZ SAWEEZ SAWEEZ SAWEEZ



SSC -11-16-75
21.5 cm / 8½"

Wertheim-Cullen

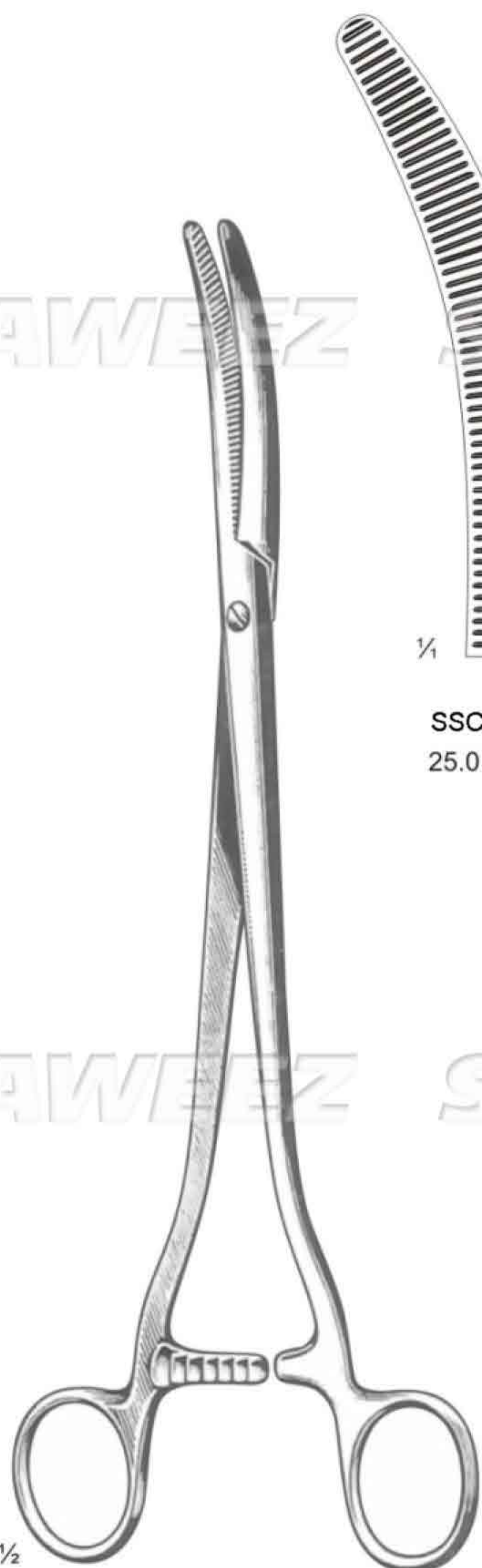


SSC -11-16-76
24.0 cm / 9½"

Extra Strong

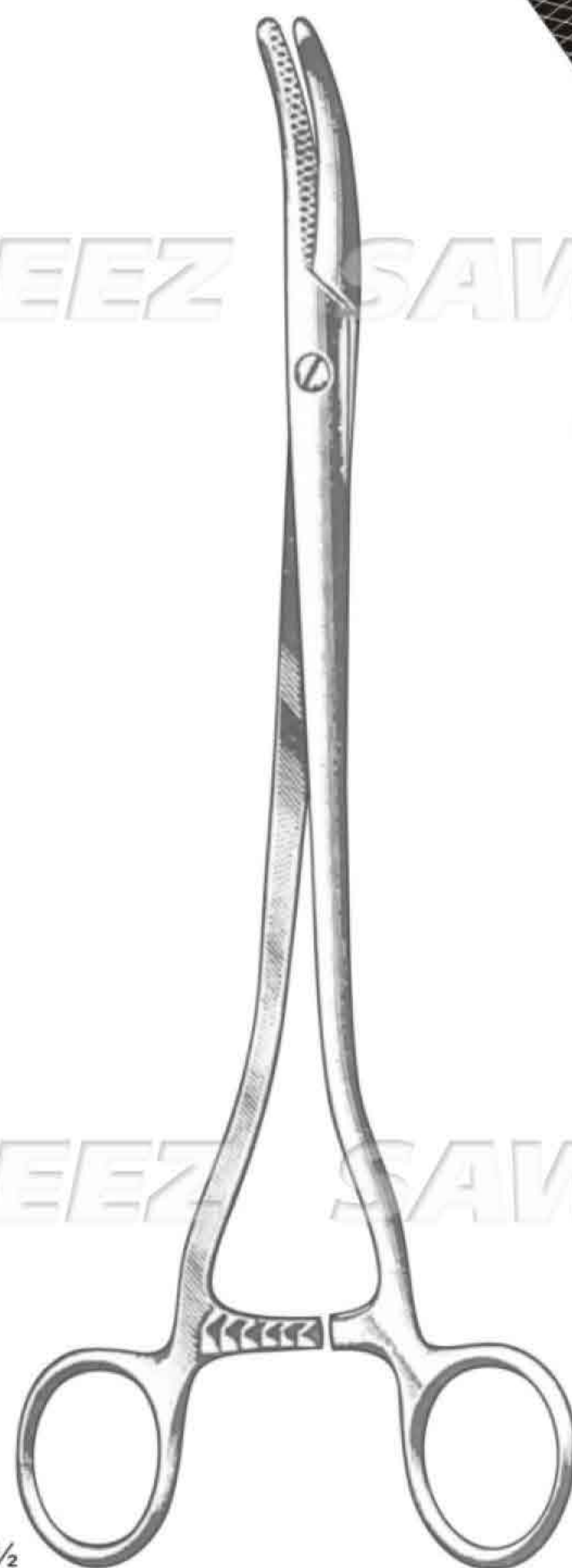
Wertheim

SAWEEZ SAWEEZ SAWEEZ SAWEEZ



Faure

SSC -11-16-77
25.0 cm / 10"



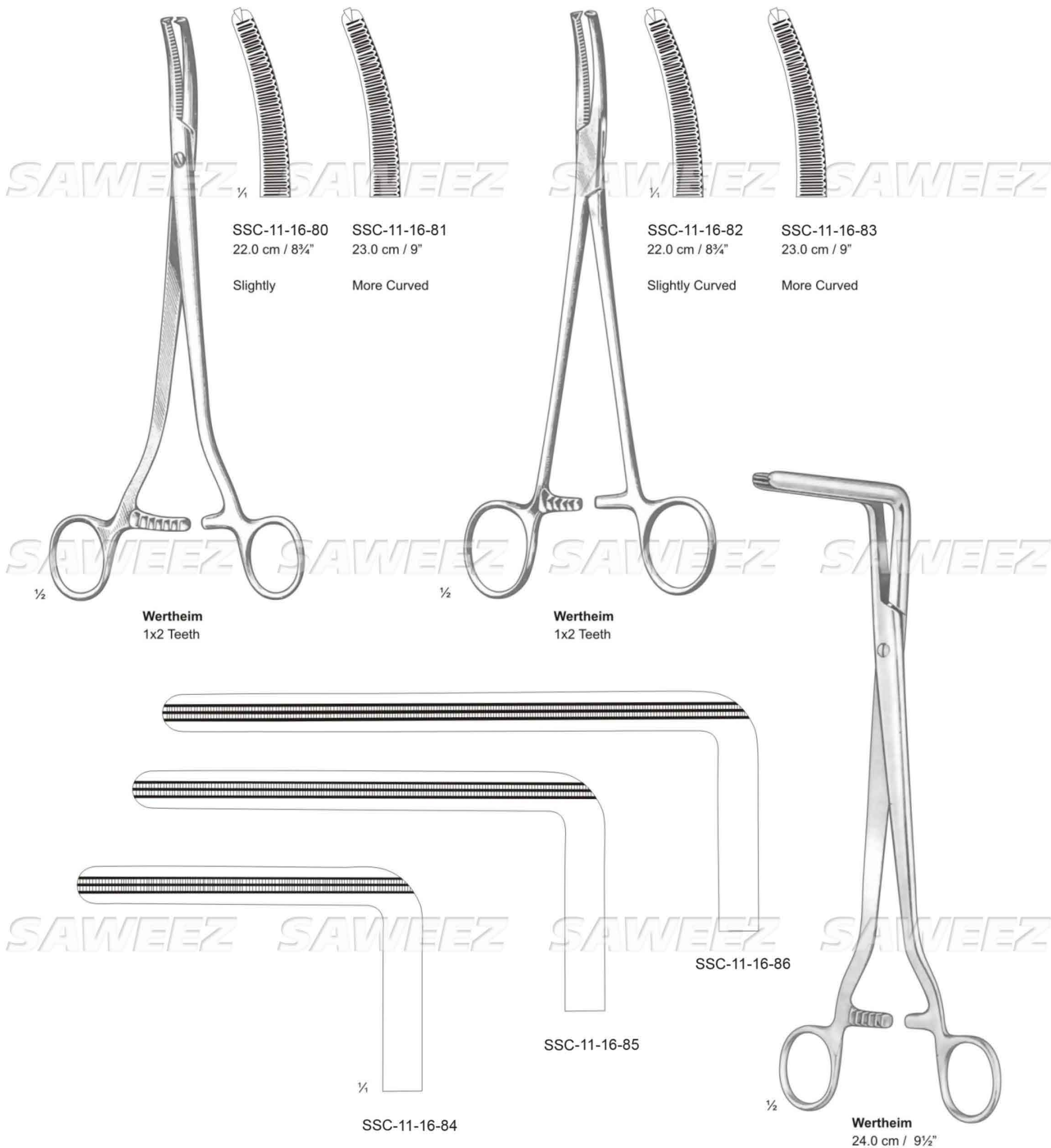
Wertheim
Heavy Pattern

SSC -11-16-78
25.0 cm / 10"



Wertheim

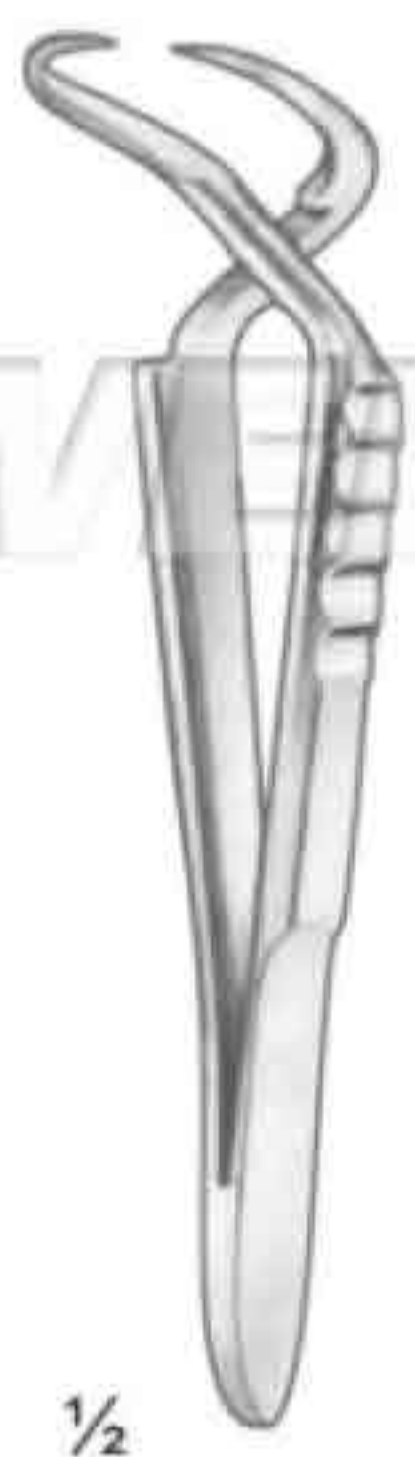
SSC -11-16-79
25.0 cm / 10"





1/2

Schaedel
SSC-11-16-87
09.0 cm / 3 1/2"



1/2

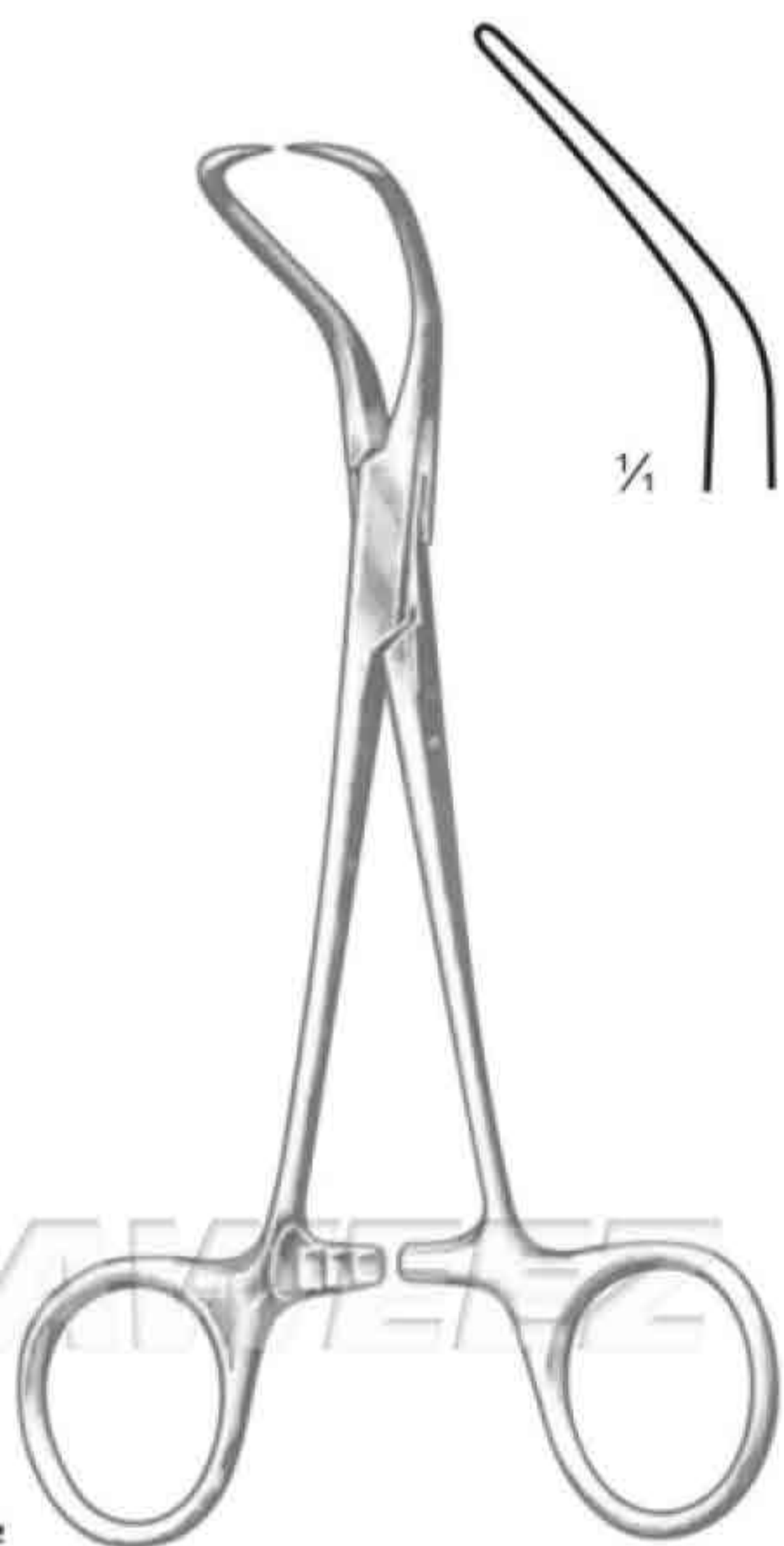
Jones
SSC-11-16-88 5.0 cm / 2"
SSC-11-16-89 9.0 cm / 3 1/2"



1/2

SSC-11-16-90 11.0 cm / 4 1/2"
SSC-11-16-91 13.0 cm / 5"

delicate pattern



1/4

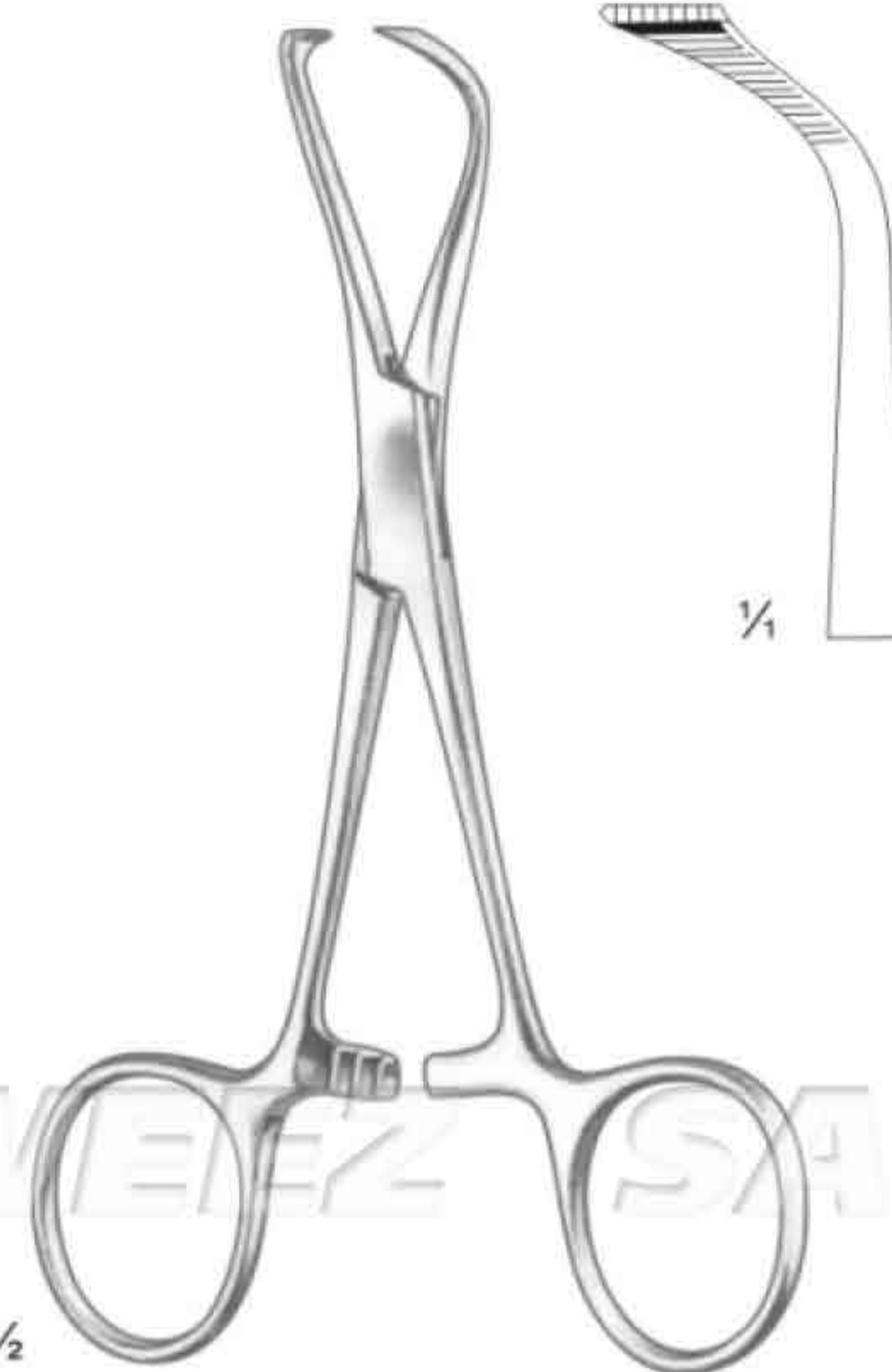
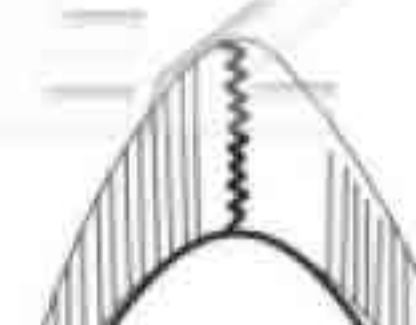
1/2

Backhaus
SSC-11-16-92 8.0 cm / 3 1/2"
SSC-11-16-93 11.0 cm / 4 1/2"
SSC-11-16-94 13.0 cm / 5"
SSC-11-16-95 15.0 cm / 6"



1/2

Roeder
SSC-11-16-96 13.0 cm / 5"
SSC-11-16-97 15.0 cm / 6"



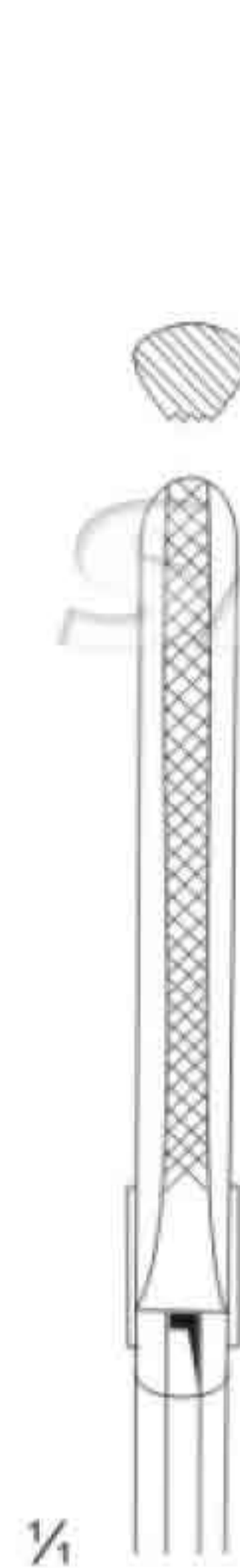
1/4

1/2

Lorna
SSC-11-16-98 10.0 cm / 4"
SSC-11-16-99 13.0 cm / 5"



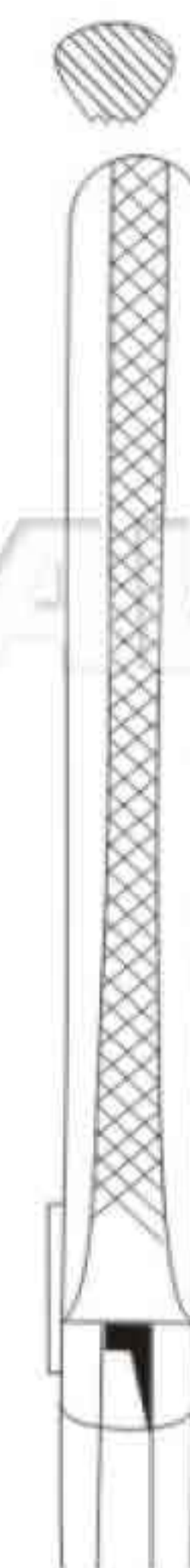
Standard



SSC-11-17-00
15.0 cm / 6"



SSC-11-17-01
18.0 cm / 7"

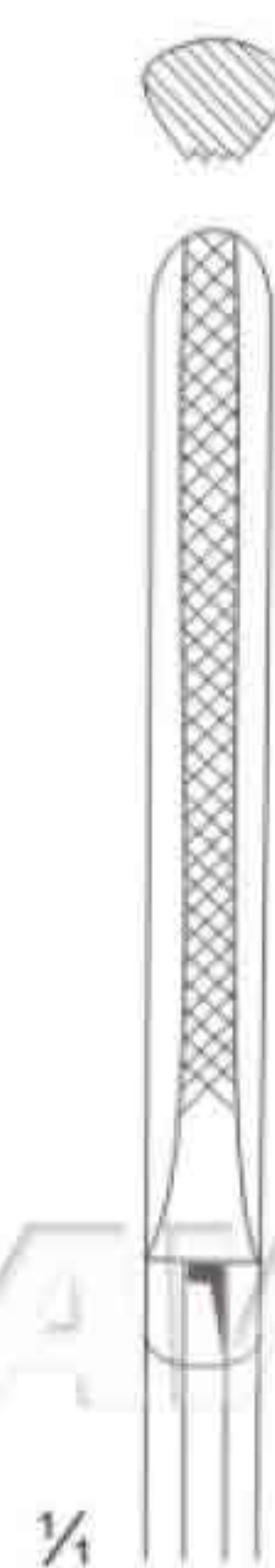
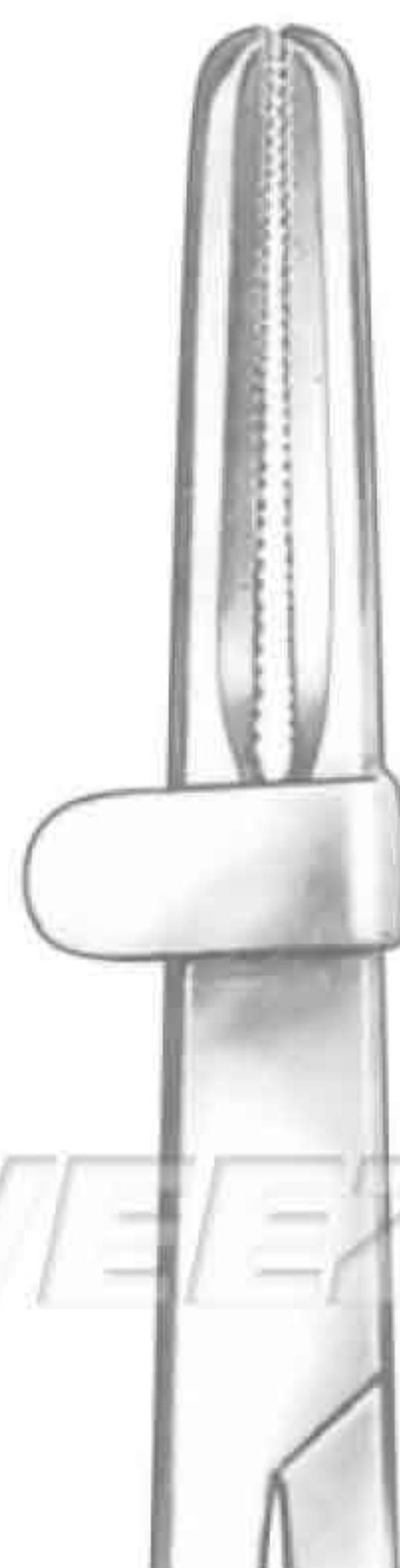


SSC-11-17-02
20.0 cm / 8"

SAWEEZ SAWEEZ SAWEEZ SAWEEZ



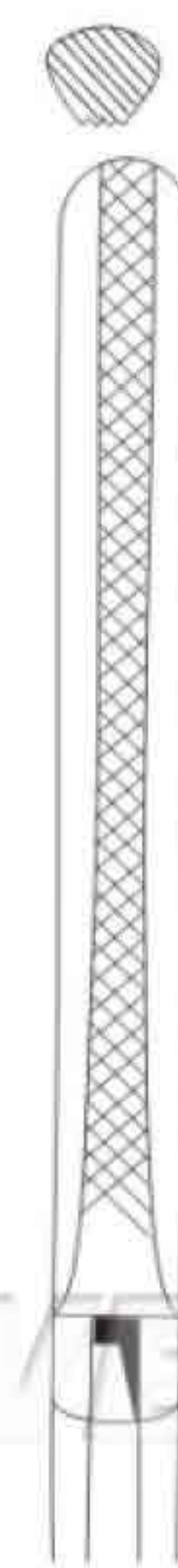
with safety guard



SSC-11-17-03
15.0 cm / 6"



SSC-11-17-04
18.0 cm / 7"



SSC-11-17-05
20.0 cm / 8"

SAWEEZ SAWEEZ SAWEEZ SAWEEZ

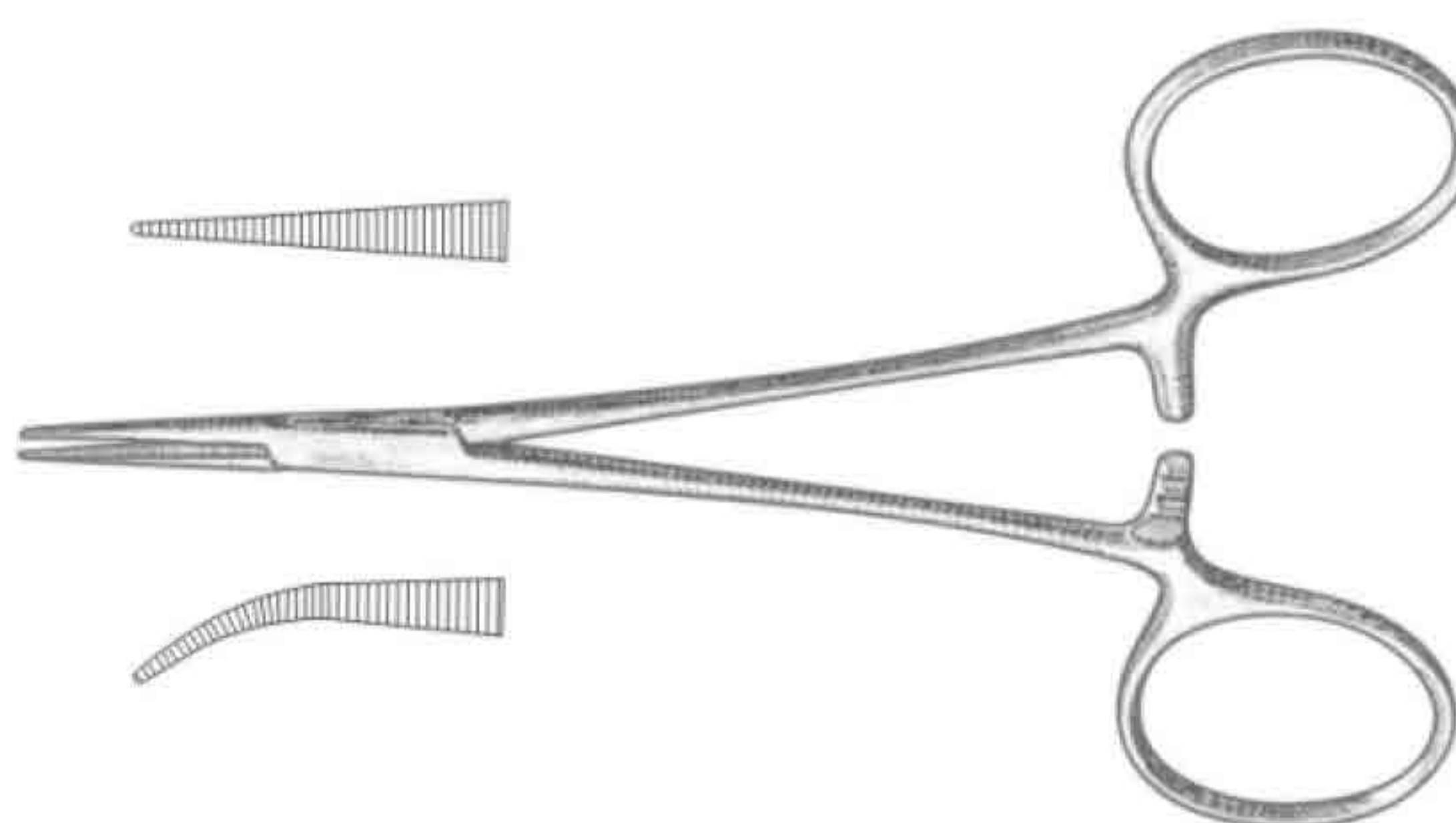


SAWEEZ SAWEEZ SAWEEZ SAWEEZ

Petit-Point Jacobson Mosquito Forceps

SSC-11-17-06 13.0 cm / 5" - Straight

SSC-11-17-07 13.0 cm / 5" - Curved



SAWEEZ SAWEEZ SAWEEZ SAWEEZ

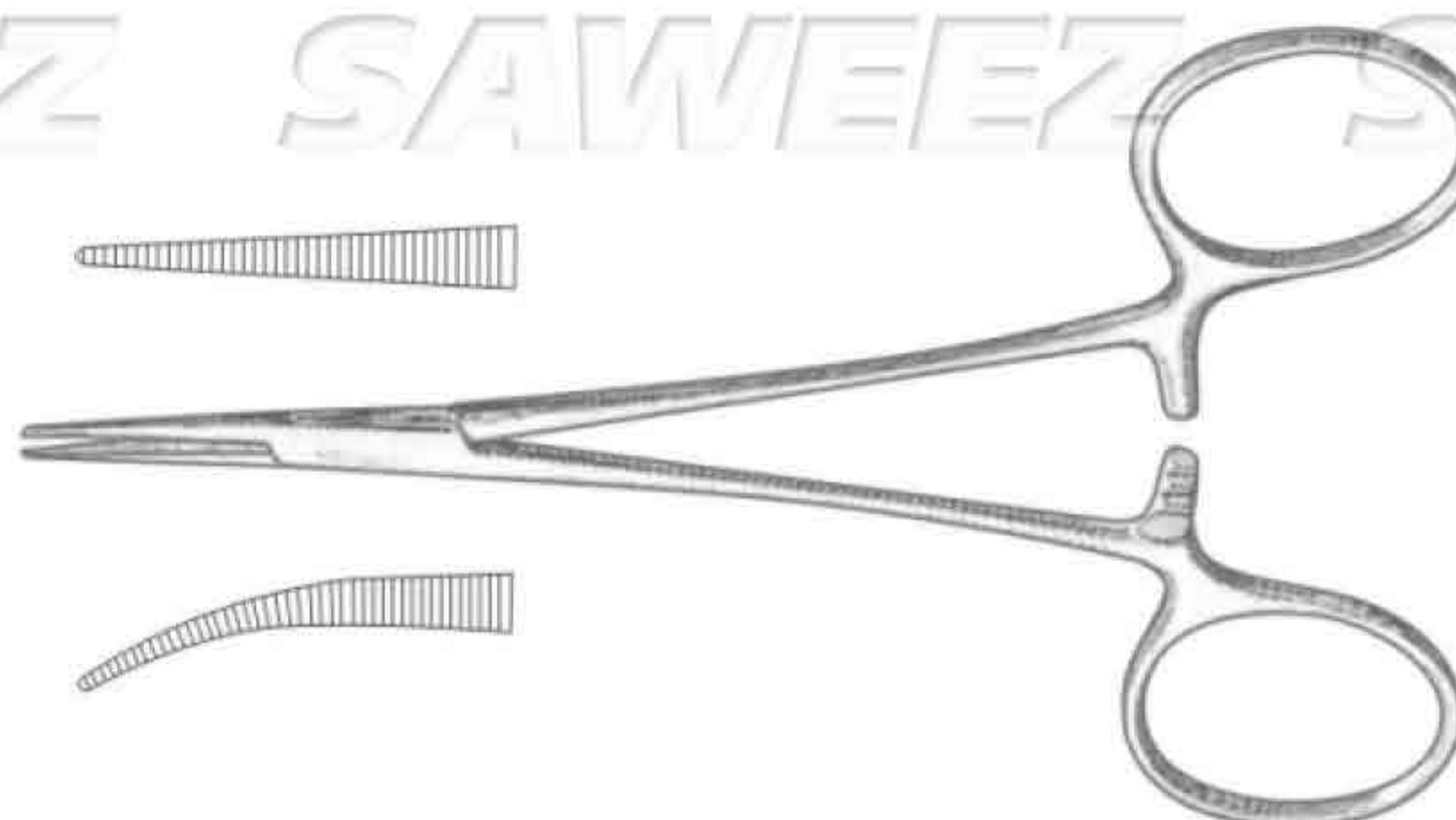
Petit-Point Mosquito Forceps

SSC-11-17-08 9.8 cm / 3 7/8" - Straight

SSC-11-17-09 9.8 cm / 3 7/8" - Curved

SSC-11-17-10 12.0 cm / 4 3/4" - Straight

SSC-11-17-11 12.0 cm / 4 3/4" - Curved

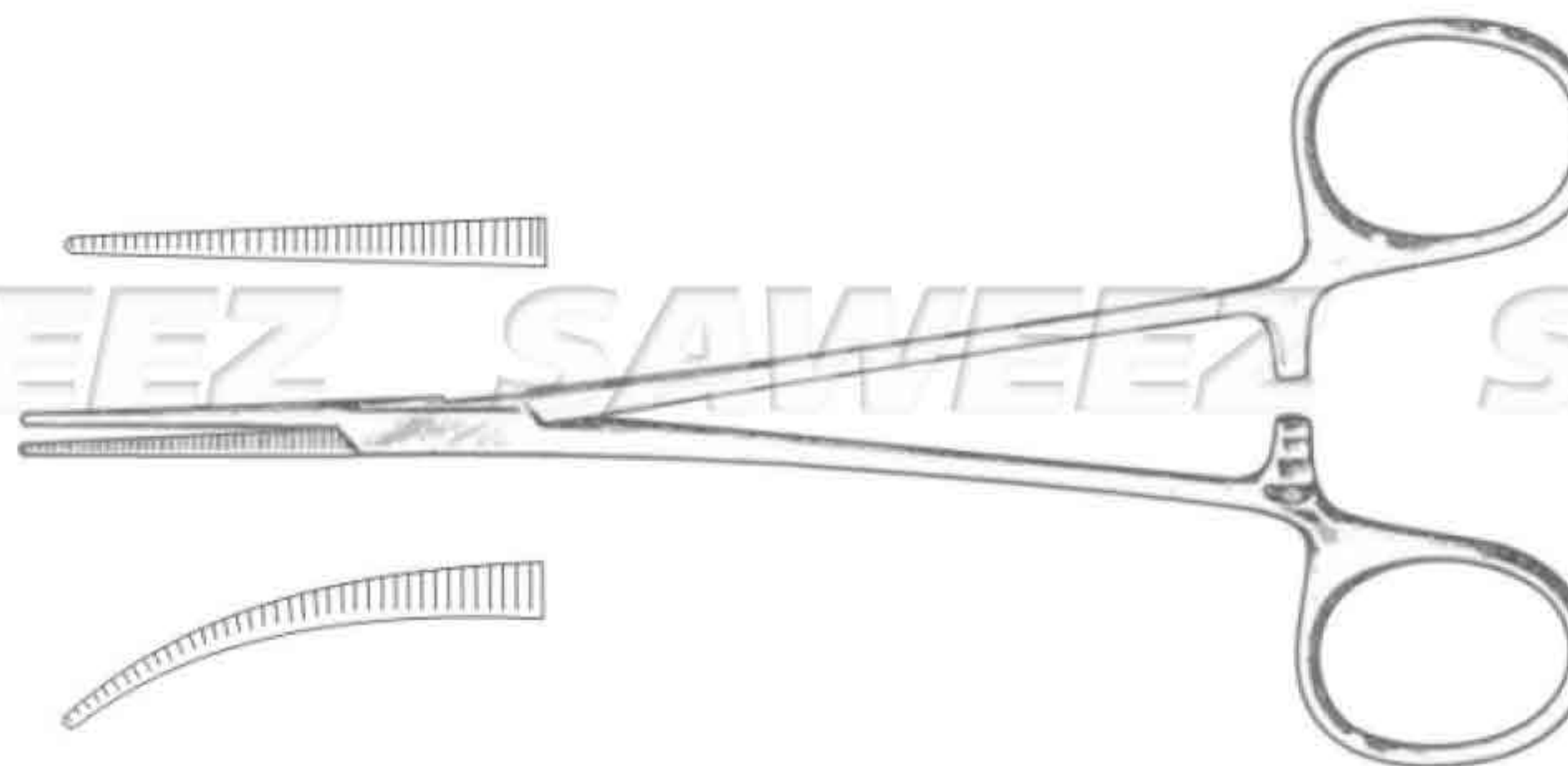


SAWEEZ SAWEEZ SAWEEZ SAWEEZ

Petit-Point Mosquito Forceps

SSC-11-17-12 15.0 cm / 6" - Straight

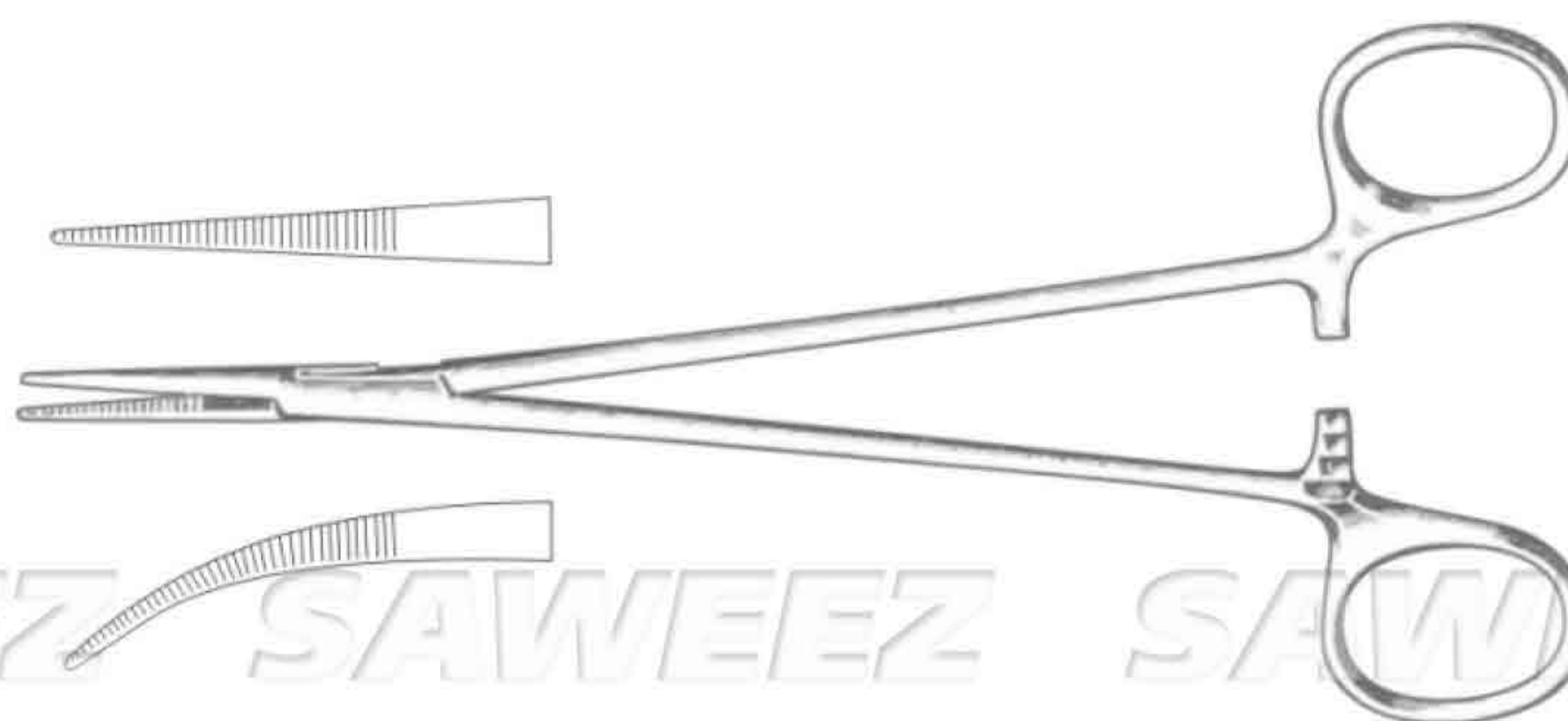
SSC-11-17-13 15.0 cm / 6" - Curved





Petit-Point Mosquito Forceps

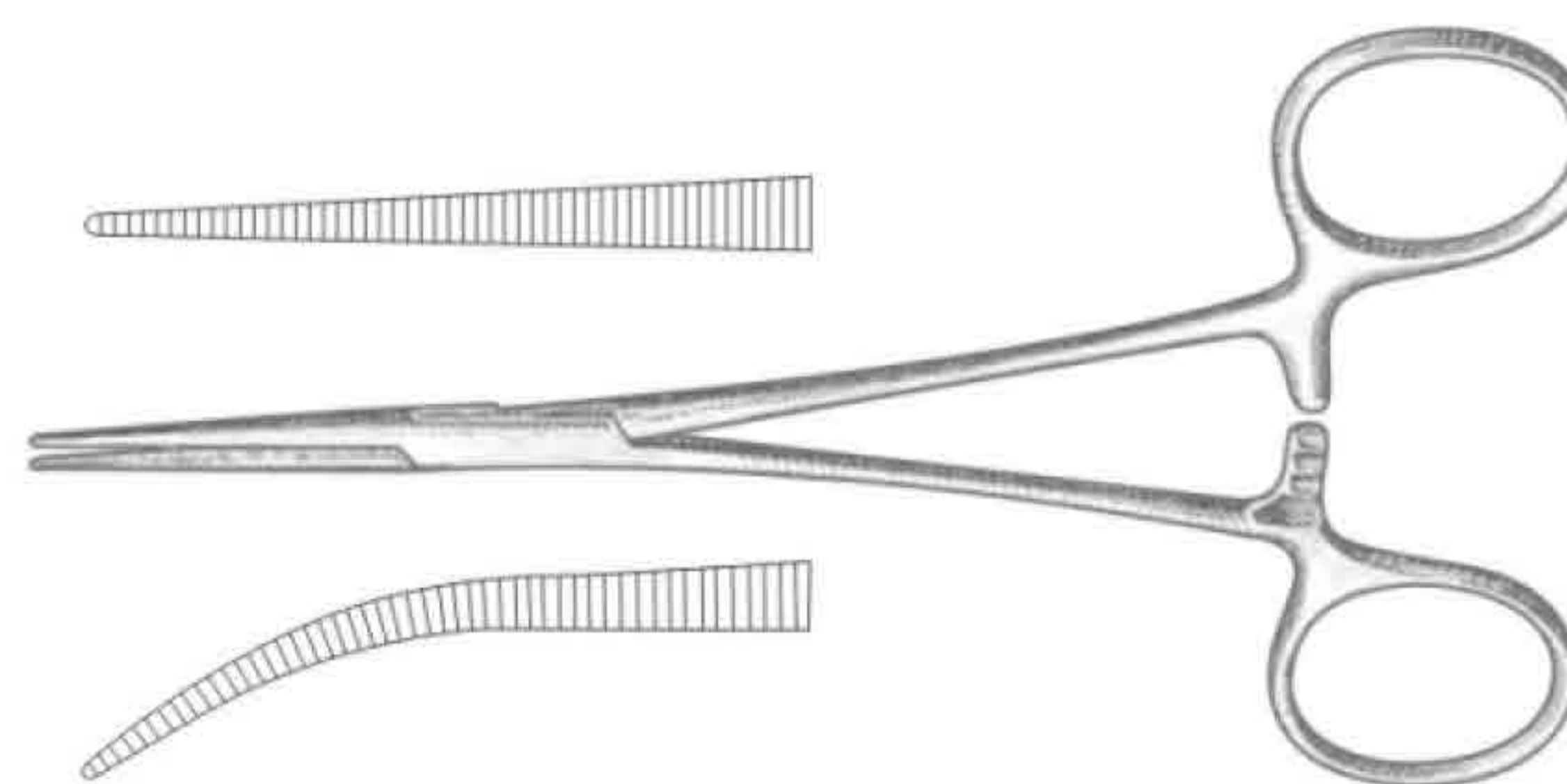
- SSC-11-17-14 18.1 cm / 7¹/₈" - Straight
- SSC-11-17-15 18.1 cm / 7¹/₈" - Curved



SAWEEZ SAWEEZ SAWEEZ SAWEEZ

Petit-Point Crile Forceps

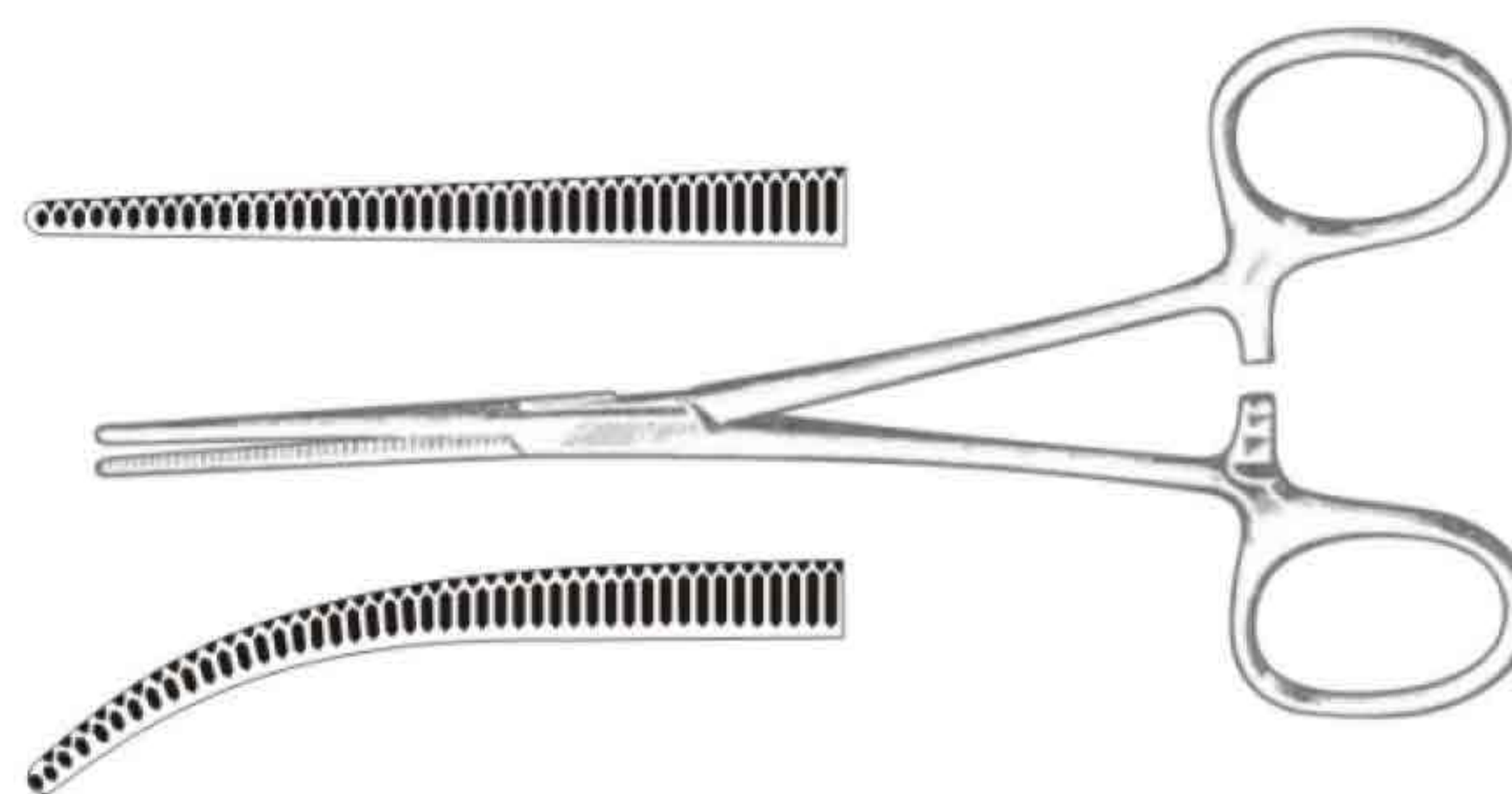
- SSC-11-17-16 14.0 cm / 5¹/₂" - Straight
- SSC-11-17-17 14.0 cm / 5¹/₂" - Curved



SAWEEZ SAWEEZ SAWEEZ SAWEEZ

Petit-Point Pean Forceps

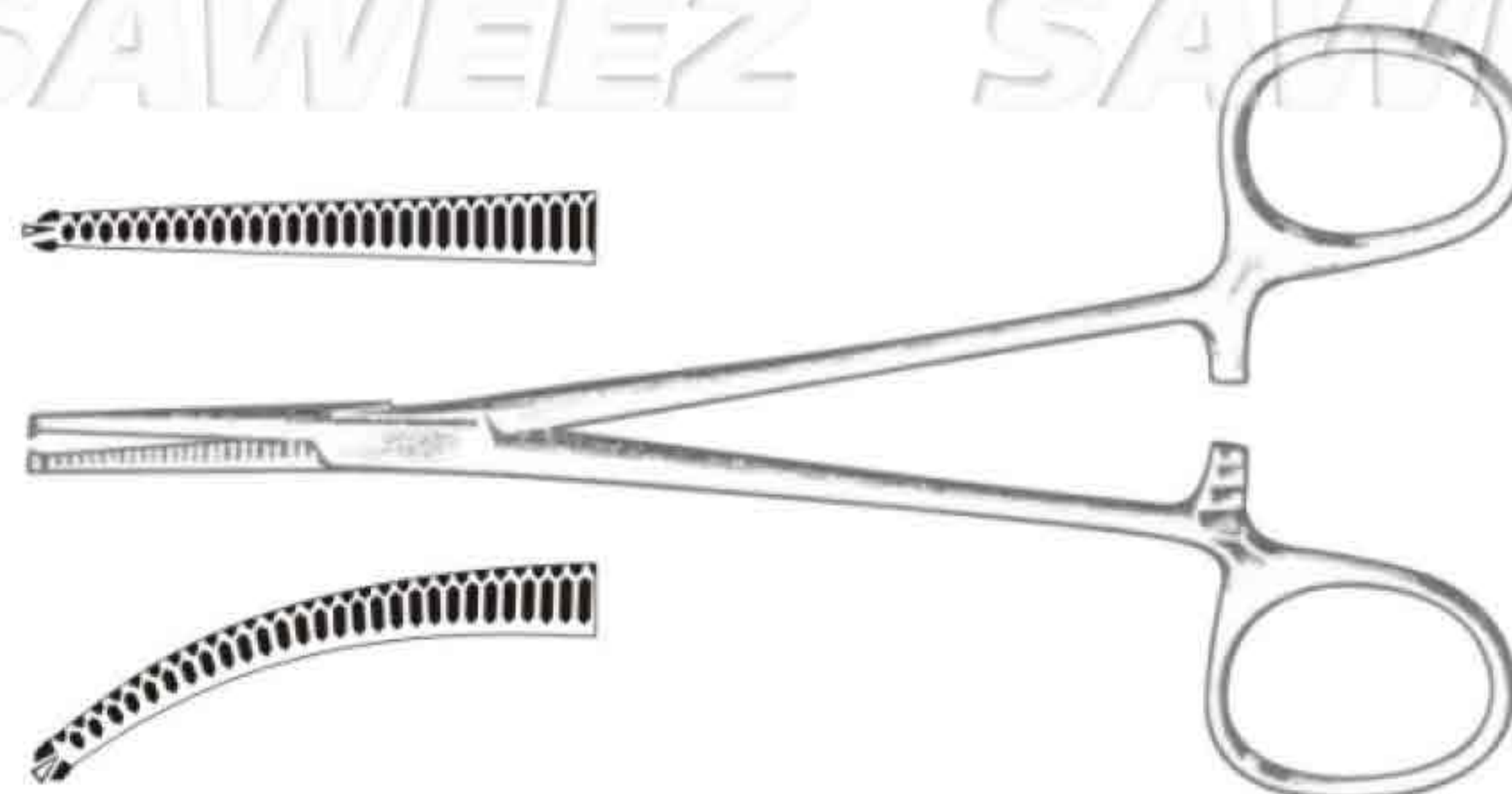
- SSC-11-17-18 14.0 cm / 5¹/₂" - Straight
- SSC-11-17-19 14.0 cm / 5¹/₂" - Curved



SAWEEZ SAWEEZ SAWEEZ SAWEEZ

Petit-Point Pean Ochsner Forceps

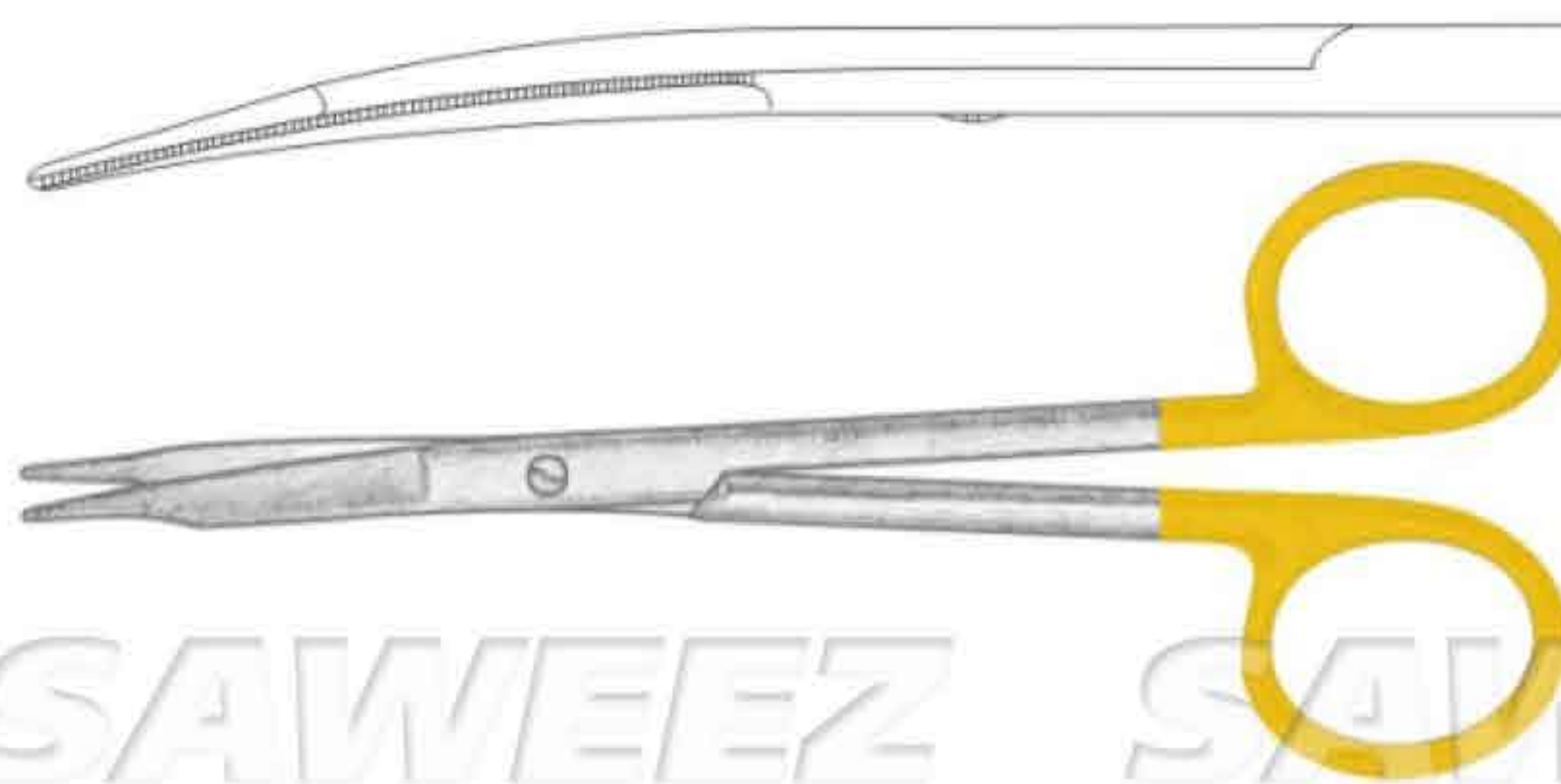
- SSC-11-17-20 14.0 cm / 5¹/₂" - Straight
- SSC-11-17-21 14.0 cm / 5¹/₂" - Curved





TC / GOLD

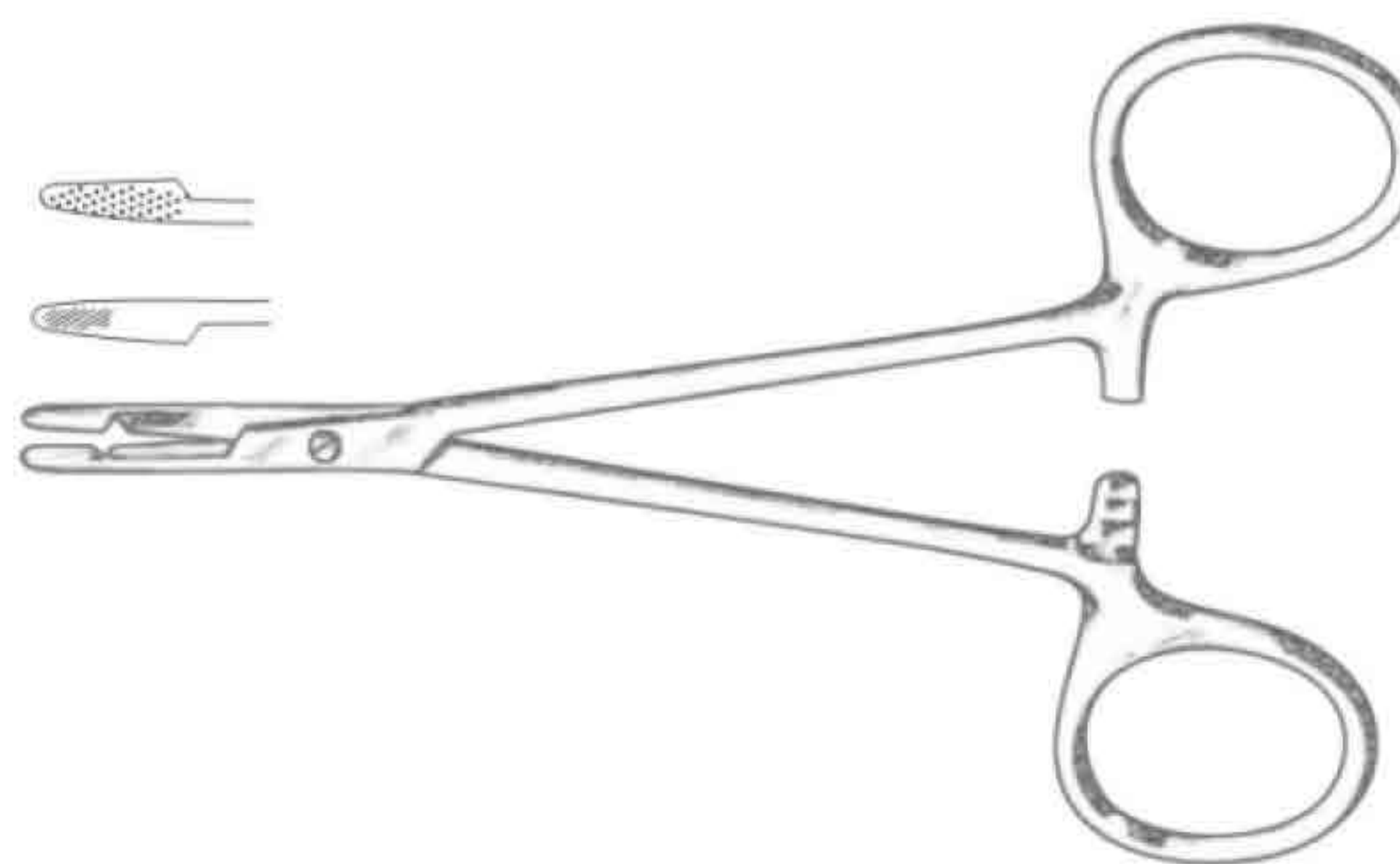
Petit-Point Reynold Scissors
SSC-11-17-22 13.0 cm / 5" - Curved
Carb-Edge blades,
one blade serrated



SAWEEZ SAWEEZ SAWEEZ SAWEEZ

Petit-Point Olsen-Hegar Needle Holders
13.0 cm / 5" - delicate

SSC-11-17-23 Serrated
SSC-11-17-24 Smooth



SAWEEZ SAWEEZ SAWEEZ SAWEEZ

Petit-Point Olsen-Hegar Needle Holders
13.0 cm / 5" - delicate **Carb-Bite** jaws

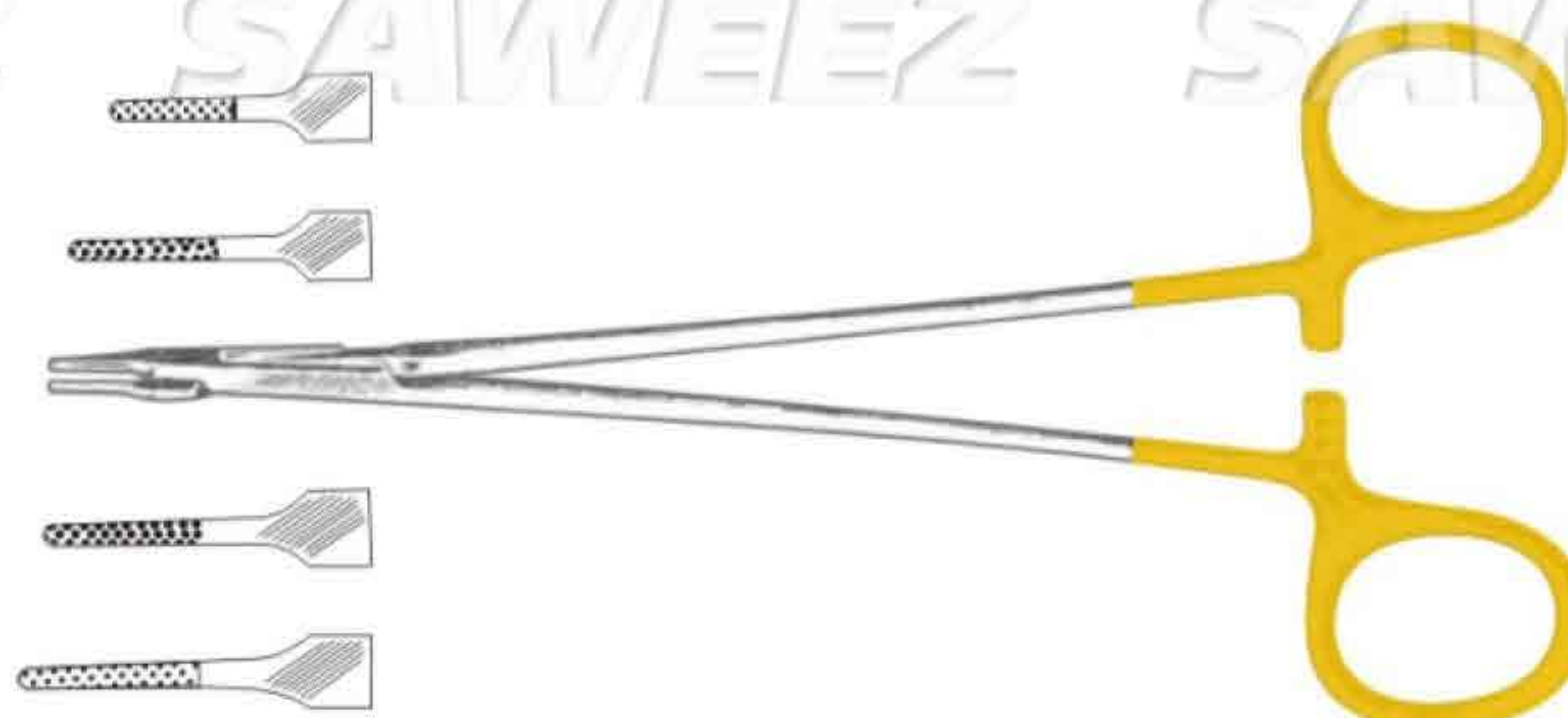
SSC-11-17-25 Serrated
SSC-11-17-26 Smooth



SAWEEZ SAWEEZ SAWEEZ SAWEEZ

Petit-Point Ryder Needle Holders
1mm **Carb-Bite** jaws, serrated

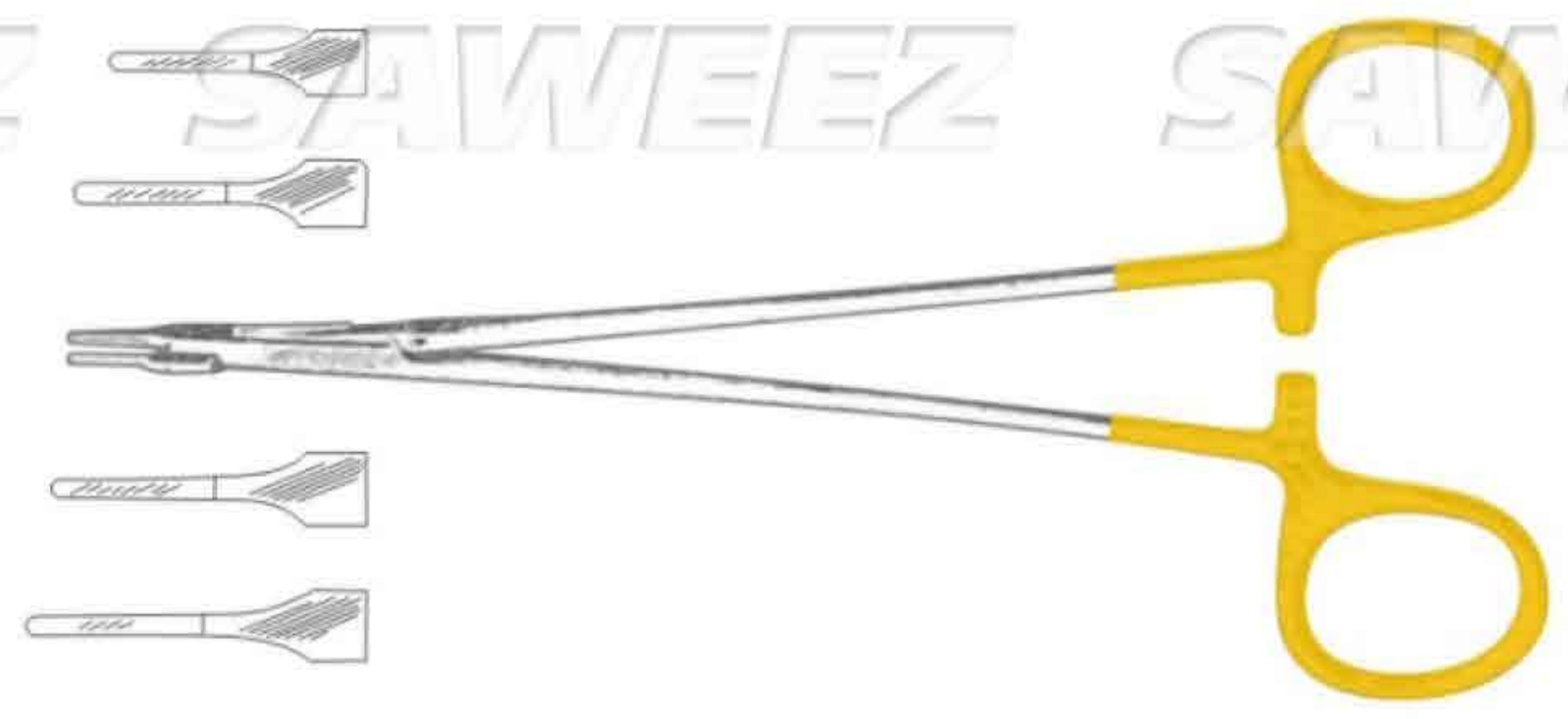
SSC-11-17-27 13.0 cm / 5"
SSC-11-17-28 15.0 cm / 6"
SSC-11-17-29 18.0 cm / 7"
SSC-11-17-30 23.0 cm / 9"



TC / GOLD

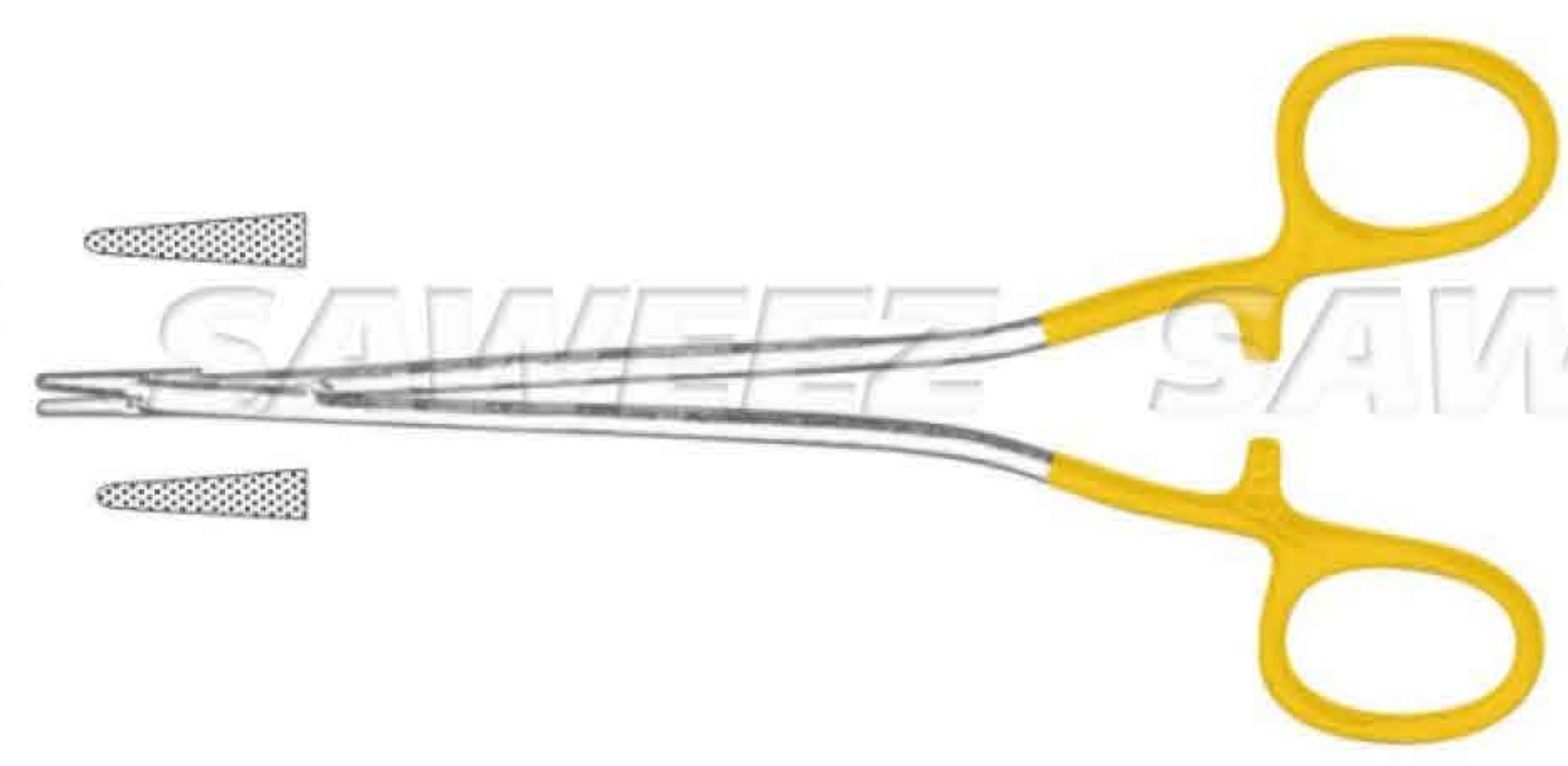
Petit-Point Ryder Needle Holders
1mm Carb-Bite jaws, smooth

- SSC-11-17-31 12.7 cm / 5"
- SSC-11-17-32 15.0 cm / 6"
- SSC-11-17-33 18.0 cm / 7"
- SSC-11-17-34 23.0 cm / 9"

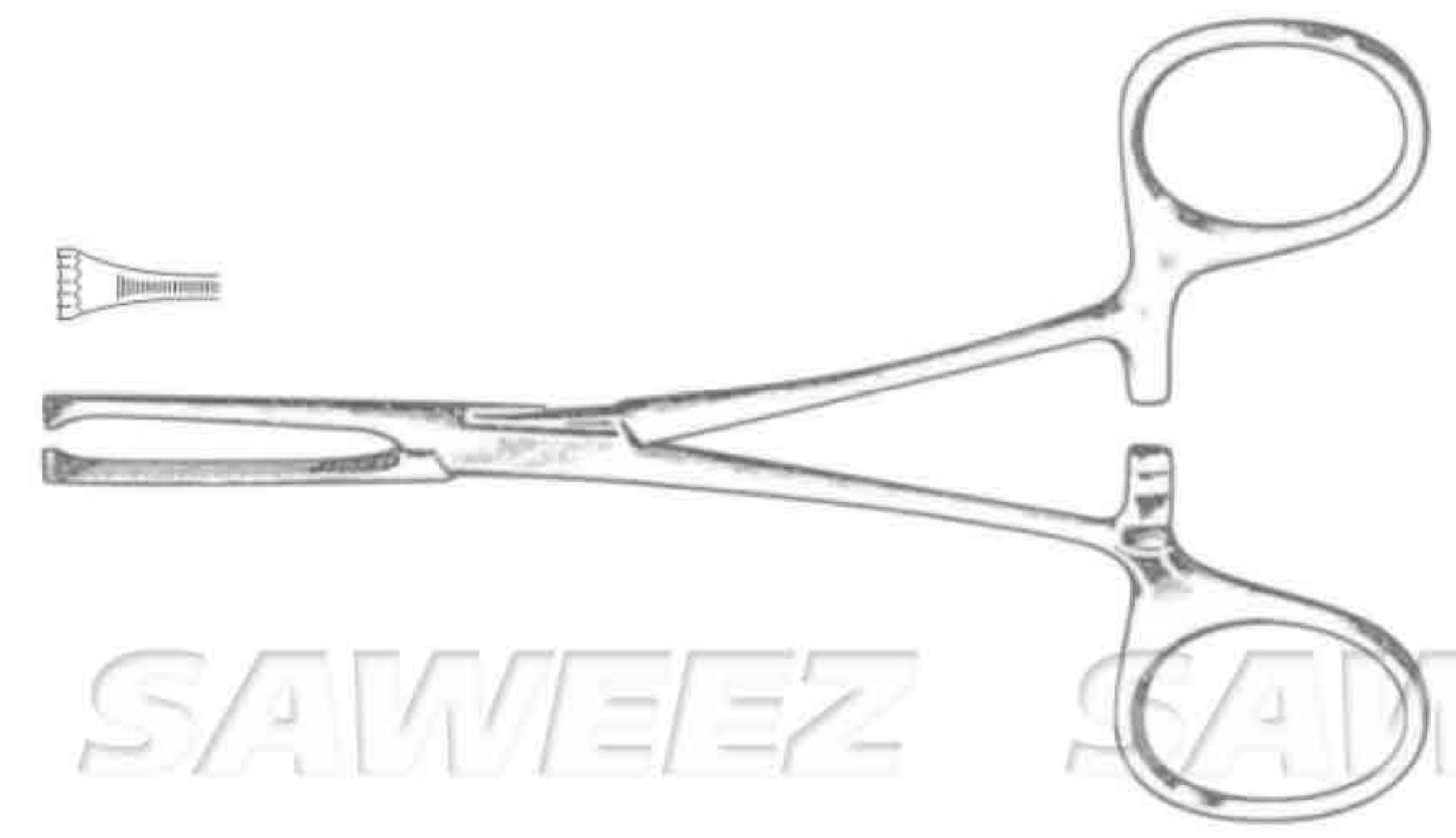


Petit-Point Sarot Needle Holders
1mm Carb-Bite jaws, delicate

- SSC-11-17-35 15.0 cm / 6"
- SSC-11-17-36 16.8 cm / 6 5/8"



Petit-Point Allis Tissue Forceps
SSC-11-17-37 13.3 cm / 5 1/4"
3x4 teeth

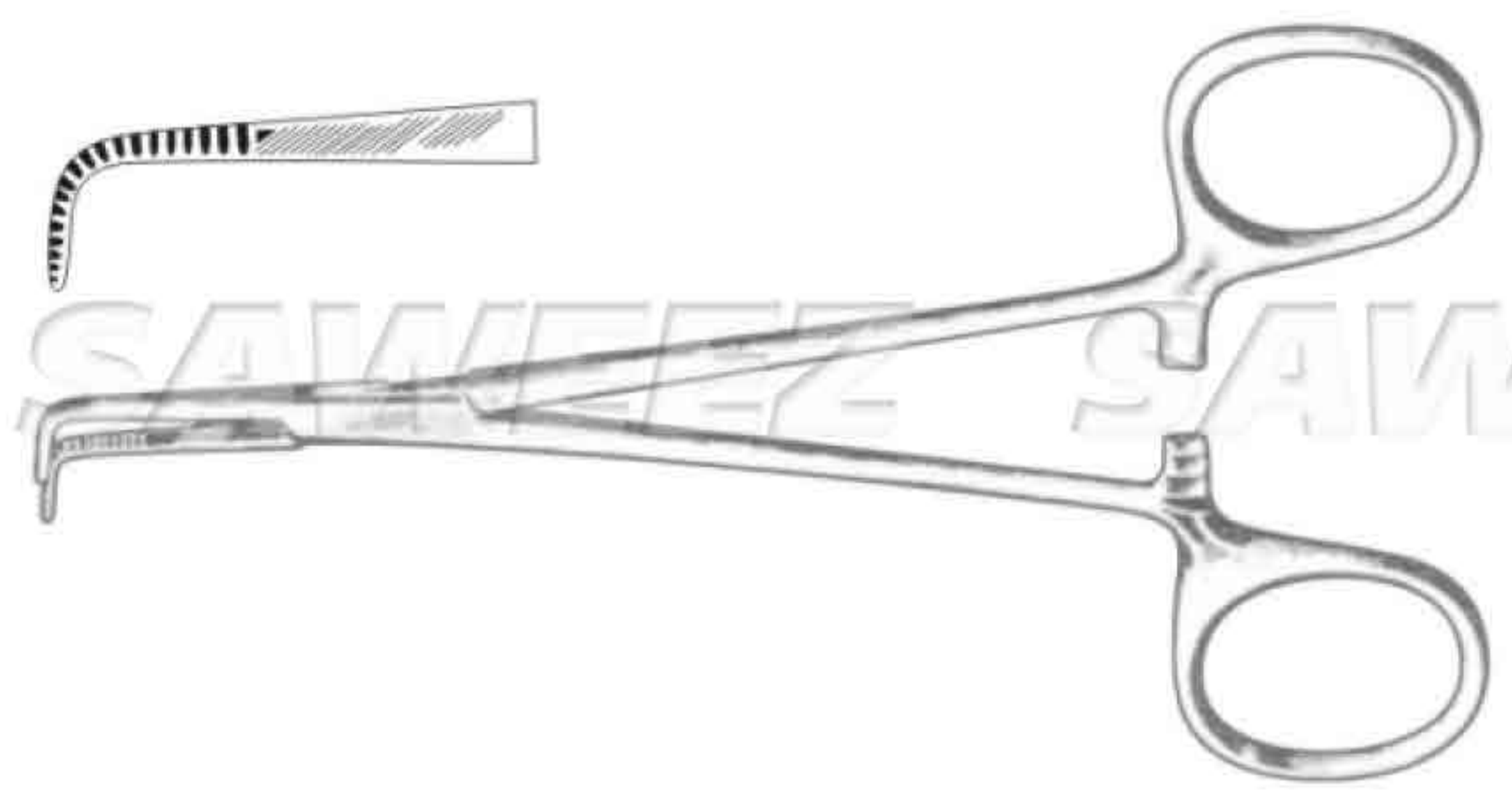


SAWEEZ SAWEEZ SAWEEZ SAWEEZ

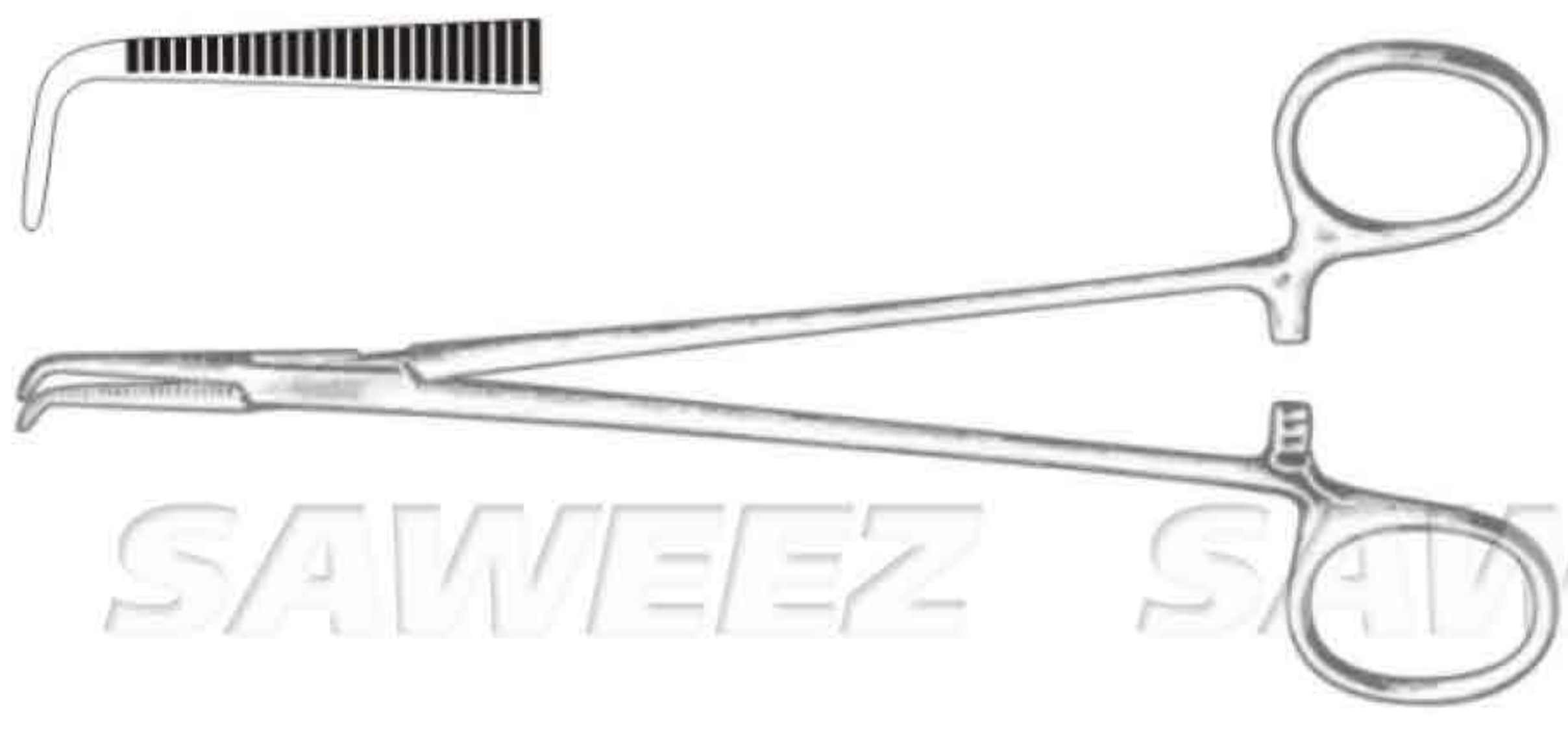
Petit-Point Babcock Forceps
SSC-11-17-38 13.3 cm / 5¼" jaw width 6 mm
SSC-11-17-39 16.0 cm / 6¼" jaw width 7.5 mm



Petit-Point Mixer Forceps
SSC-11-17-40 13.3 cm / 5¼"



Petit-Point Mixer Forceps
SSC-11-17-41 18.5 cm / 7¼"



SAWEEZ SAWEEZ SAWEEZ SAWEEZ



SSC-11-17-42 20.0 cm / 8"
SSC-11-17-43 25.0 cm / 10"

SSC-11-17-44 20.0 cm / 8"
SSC-11-17-45 25.0 cm / 10"

Gross-Maier
Without ratchet

SSC-11-17-46 20.0 cm / 8"
SSC-11-17-47 25.0 cm / 10"

SSC-11-17-48 20.0 cm / 8"
SSC-11-17-49 25.0 cm / 10"

Gross-Maier
With ratchet

SSC-11-17-50 20.0 cm / 8"
SSC-11-17-51 22.0 cm / 8 3/4"
SSC-11-17-52 25.0 cm / 10"
SSC-11-17-53 27.0 cm / 10 1/2"

SSC-11-17-54 20.0 cm / 8"
SSC-11-17-55 22.0 cm / 8 3/4"
SSC-11-17-56 25.0 cm / 10"
SSC-11-17-57 27.0 cm / 10 1/2"

Gross-Maier



Cheron
SSC-11-17-58
25.0 cm / 10"

Bozemann
SSC-11-17-59
26.0 cm / 10 1/4"

Bozemann-Douglas
SSC-11-17-60
26.0 cm / 10 1/4"



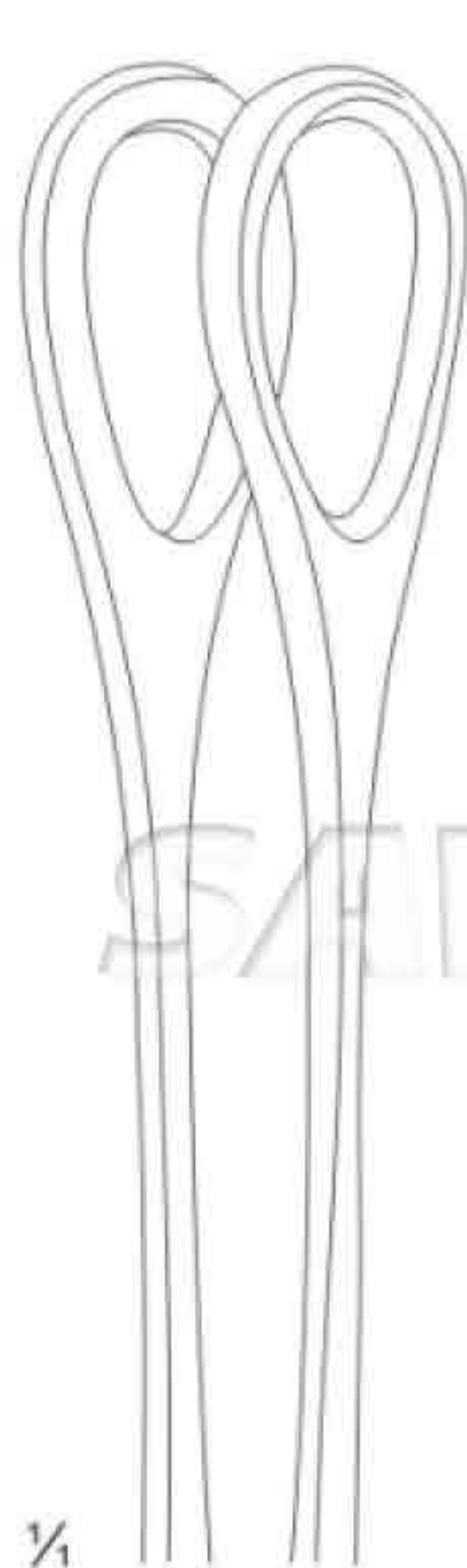
SAWEEZ SAWEEZ SAWEEZ SAWEEZ

SAWEEZ SAWEEZ SAWEEZ SAWEEZ

SAWEEZ SAWEEZ SAWEEZ SAWEEZ

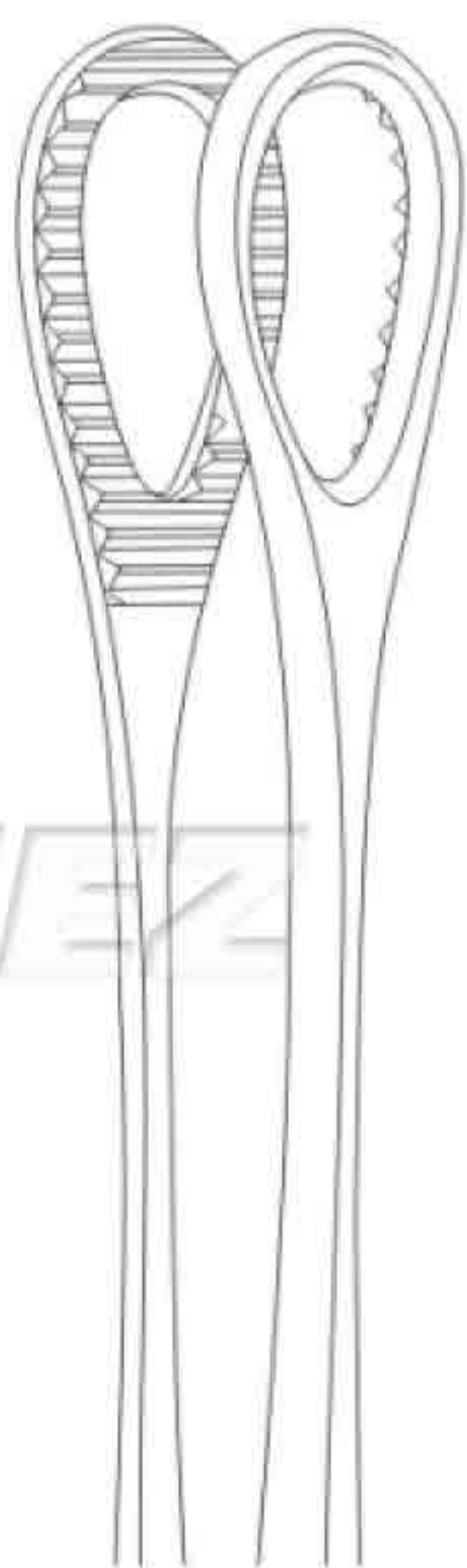


Foerster



1/4

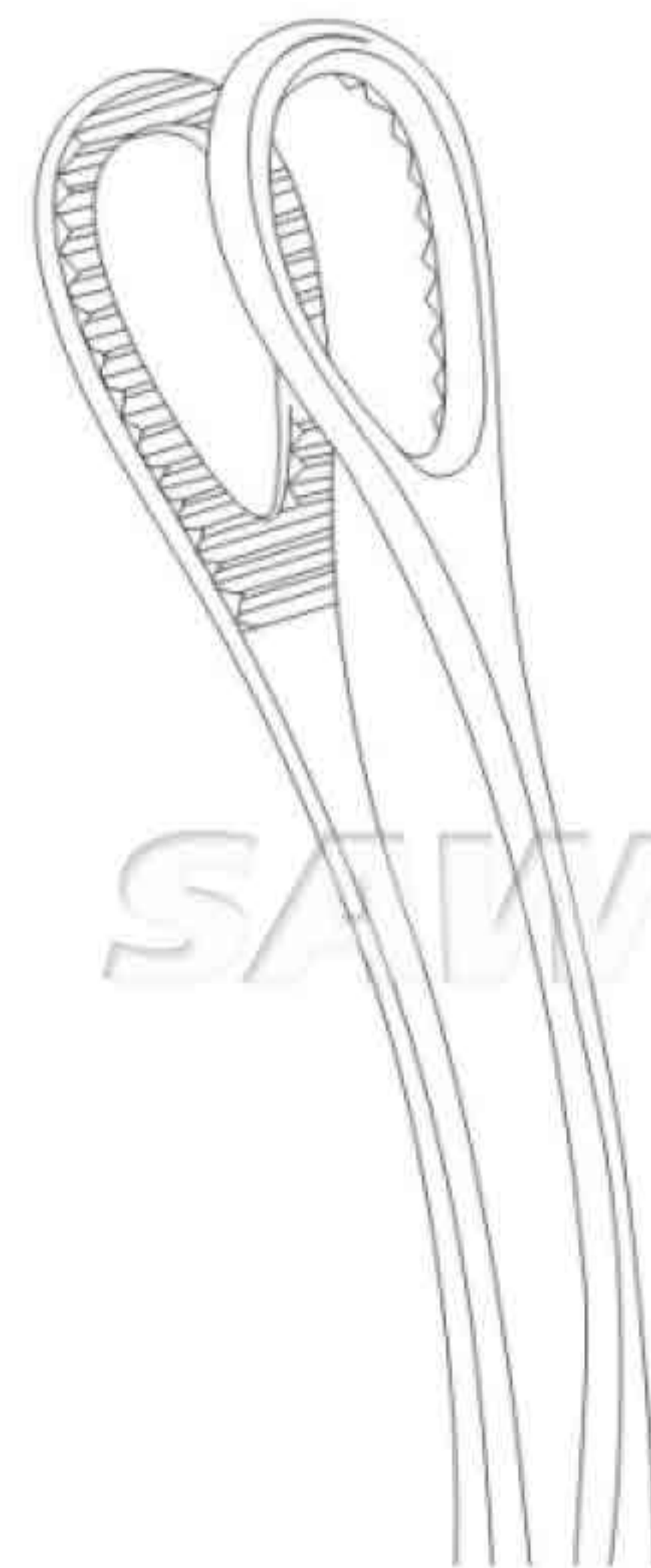
SSC-11-17-61
25.0 cm / 10"



SSC-11-17-62 18.0 cm / 7"
SSC-11-17-63 20.0 cm / 8"
SSC-11-17-64 25.0 cm / 10"



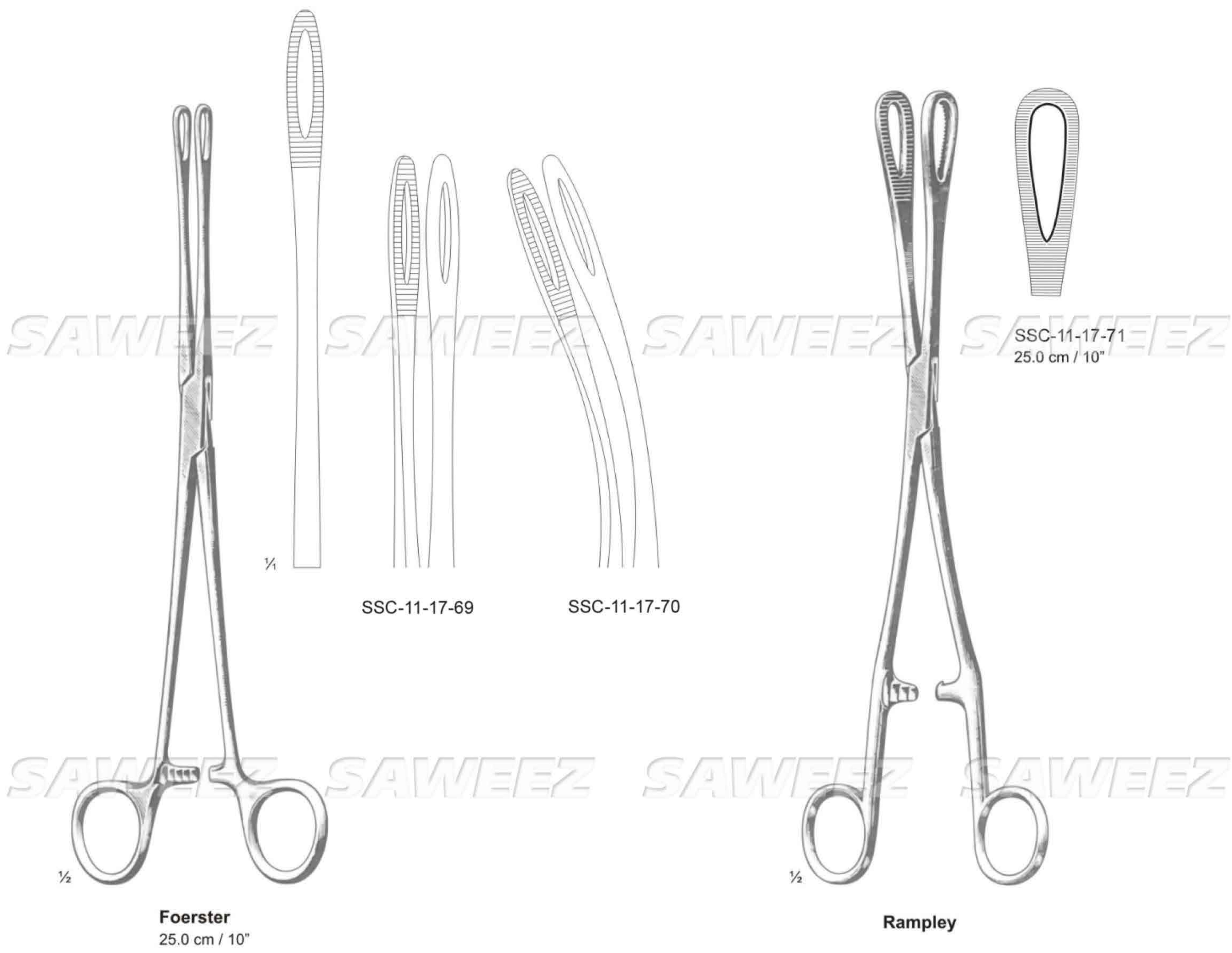
SSC-11-17-65
25.0 cm / 10"



SSC-11-17-66 18.0 cm / 7"
SSC-11-17-67 20.0 cm / 8"
SSC-11-17-68 25.0 cm / 10"



SAWEEZ SAWEEZ SAWEEZ SAWEEZ



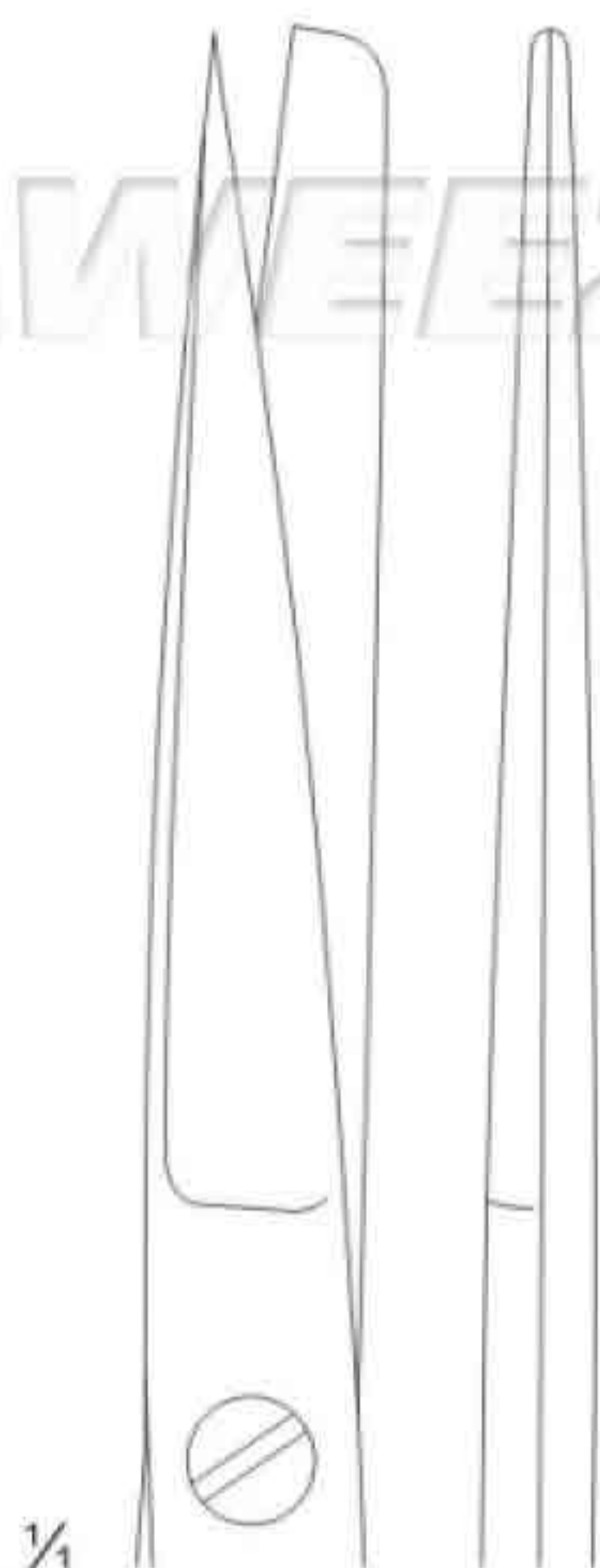


TC / GOLD



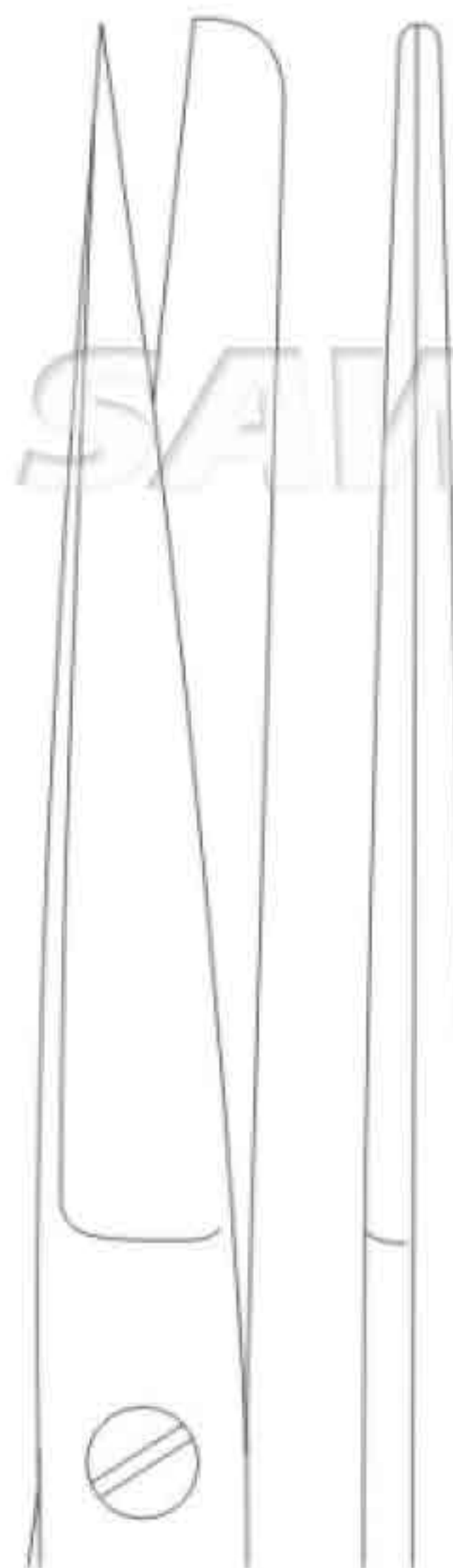
1/2

Standard

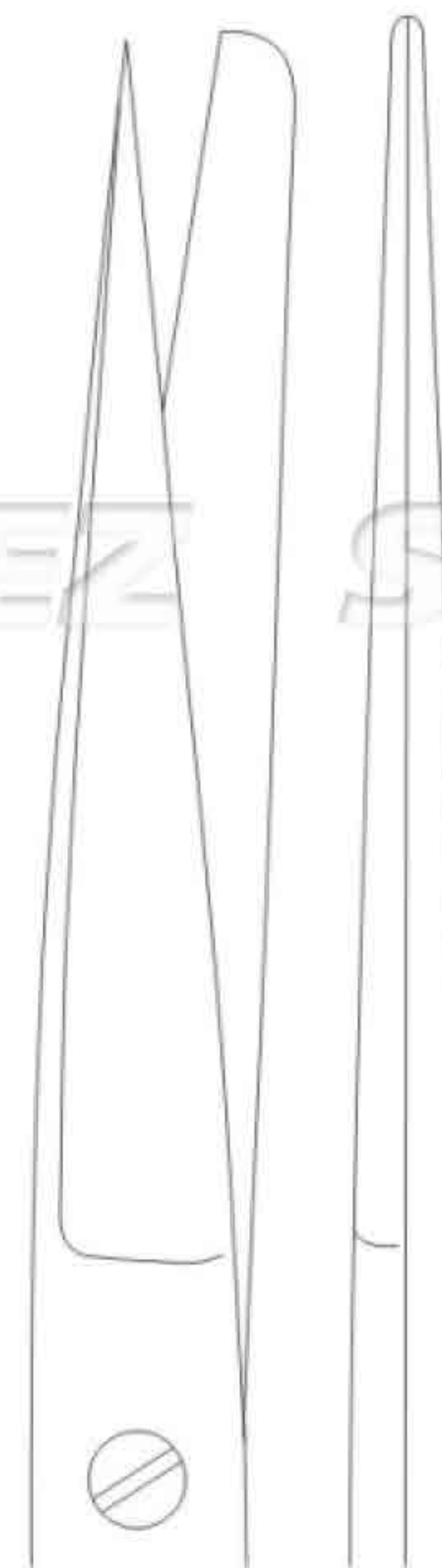


1/4

SSC-11-17-72
14.5 cm / 5 3/4"



SSC-11-17-73
16.5 cm / 6 1/2"

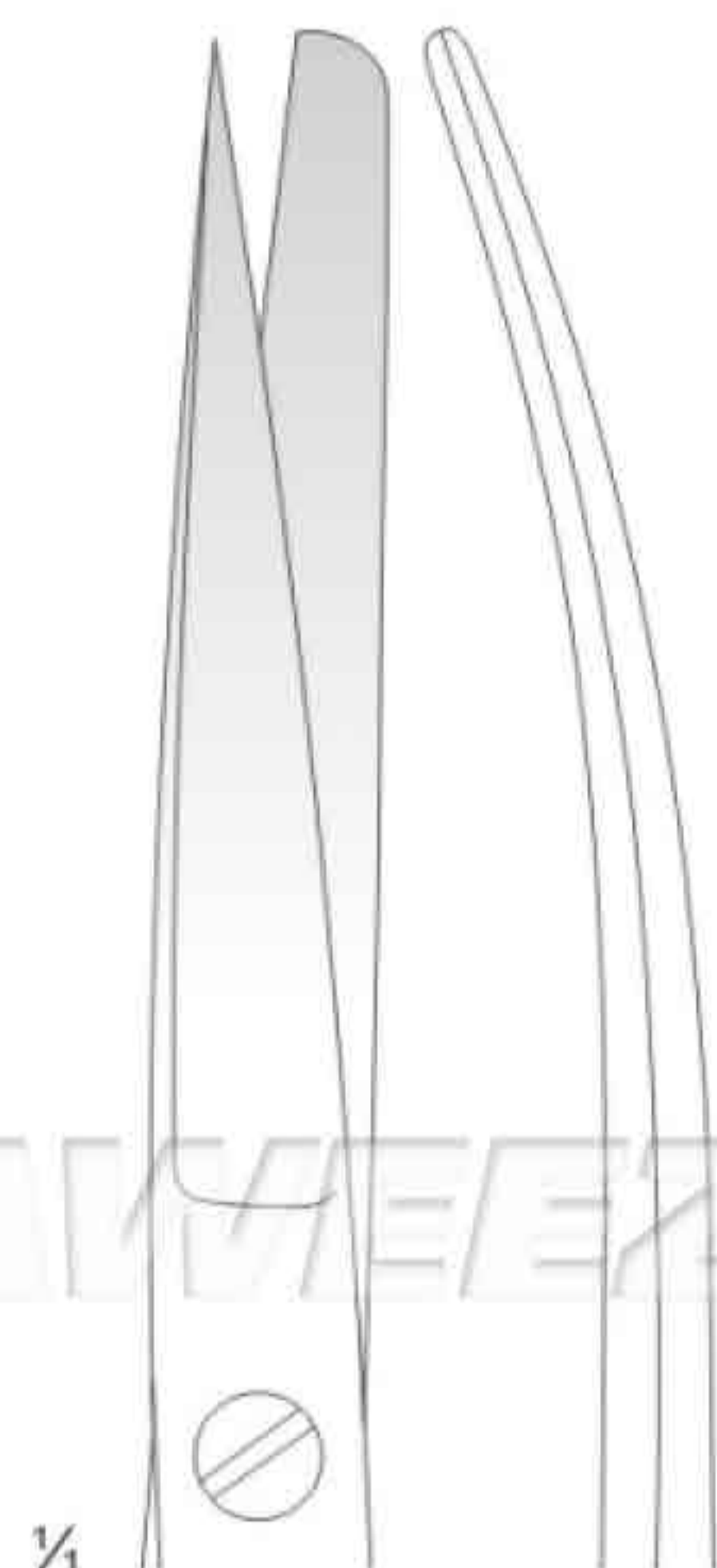


SSC-11-17-74
18.5 cm / 7 1/4"



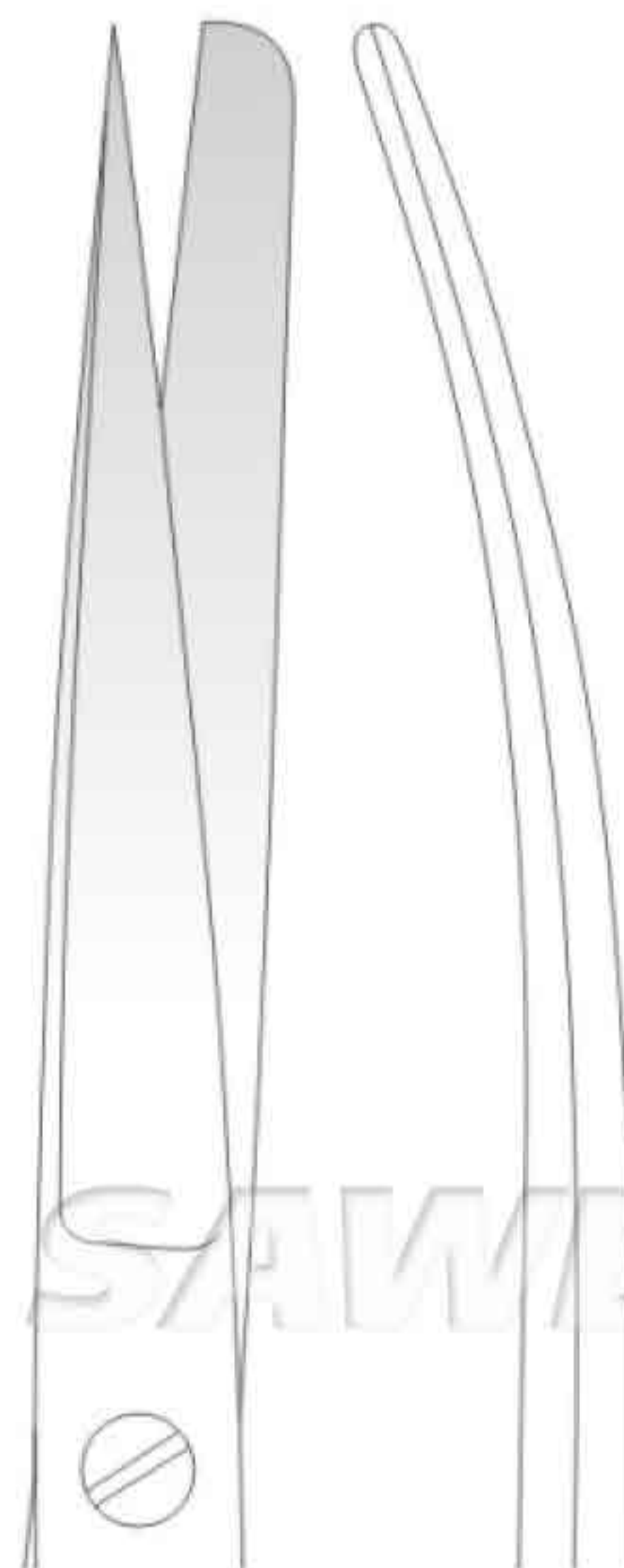
1/2

Standard

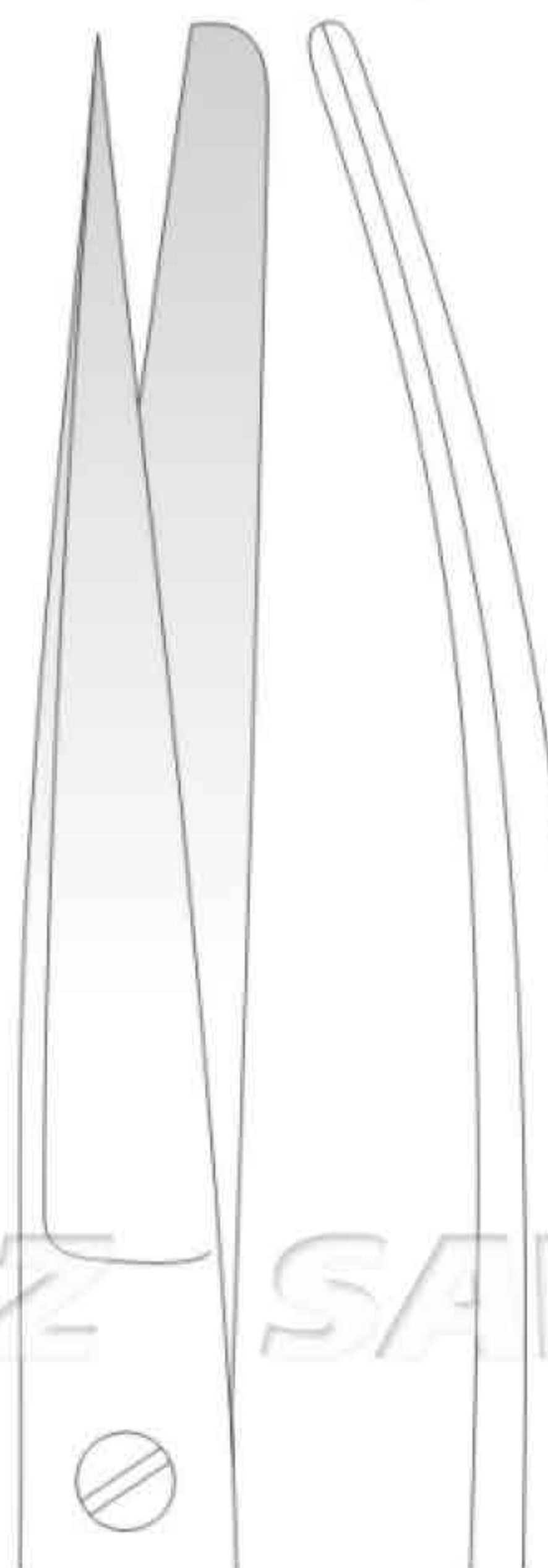


1/4

SSC-11-17-75
14.5 cm / 5 3/4"



SSC-11-17-76
16.5 cm / 6 1/2"



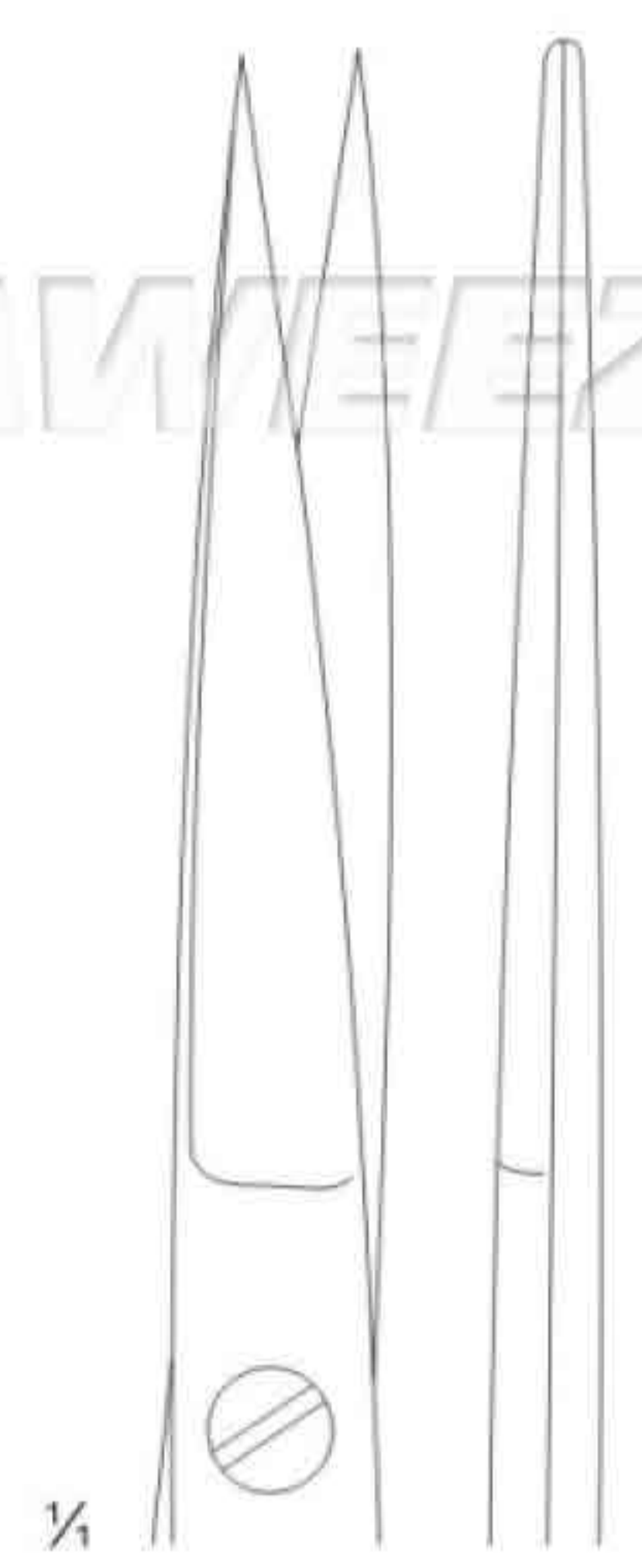
SSC-11-17-77
18.5 cm / 7 1/4"



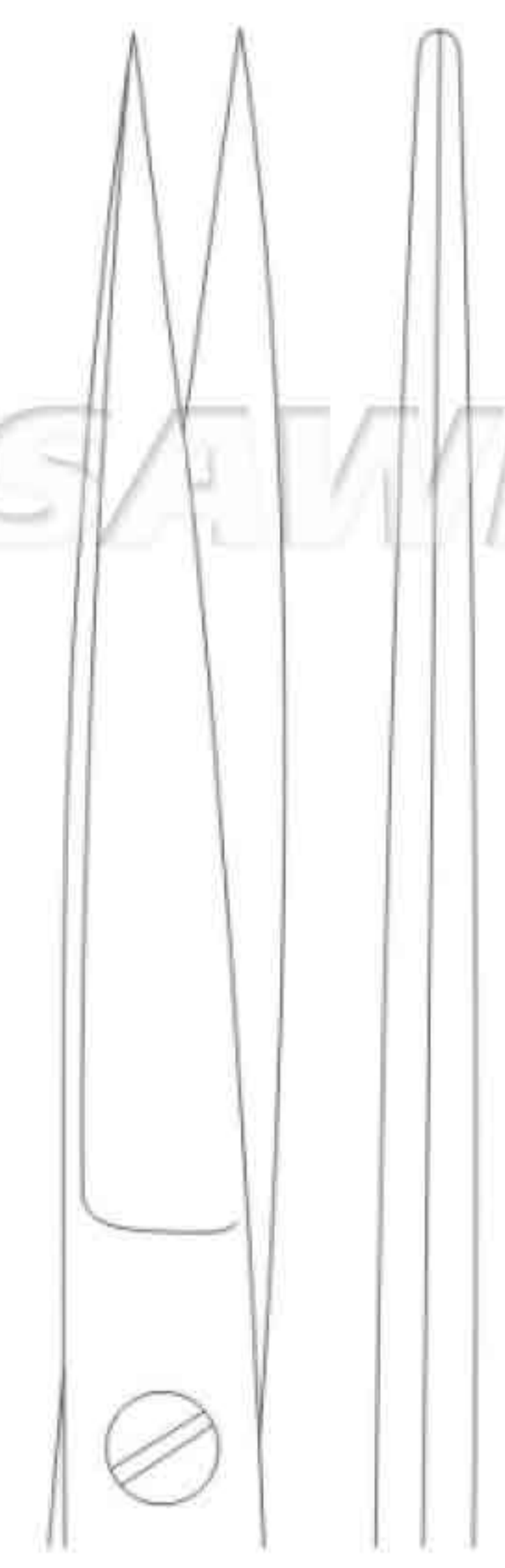
TC / GOLD



Standard



SSC-11-17-78
14.5 cm / 5 3/4"



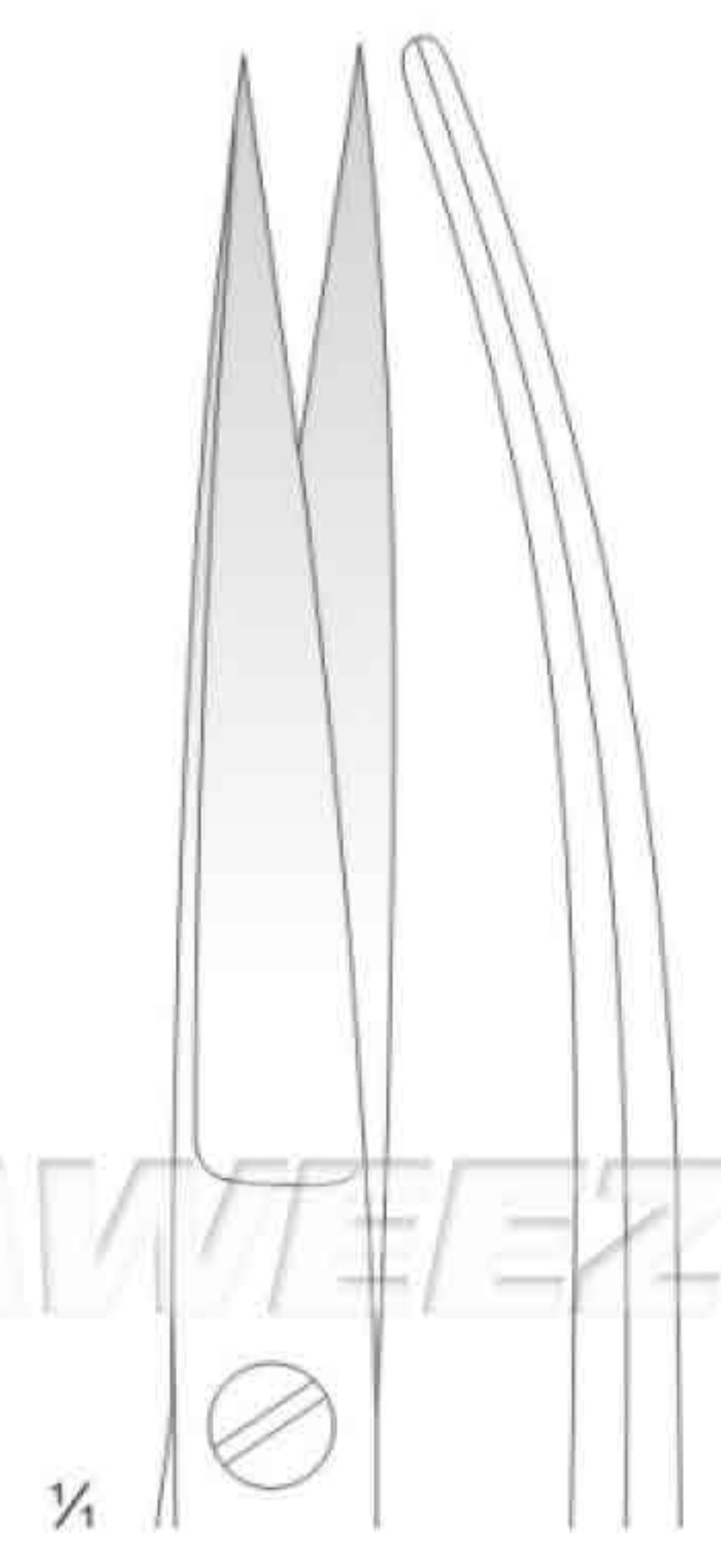
SSC-11-17-79
16.5 cm / 6 1/2"



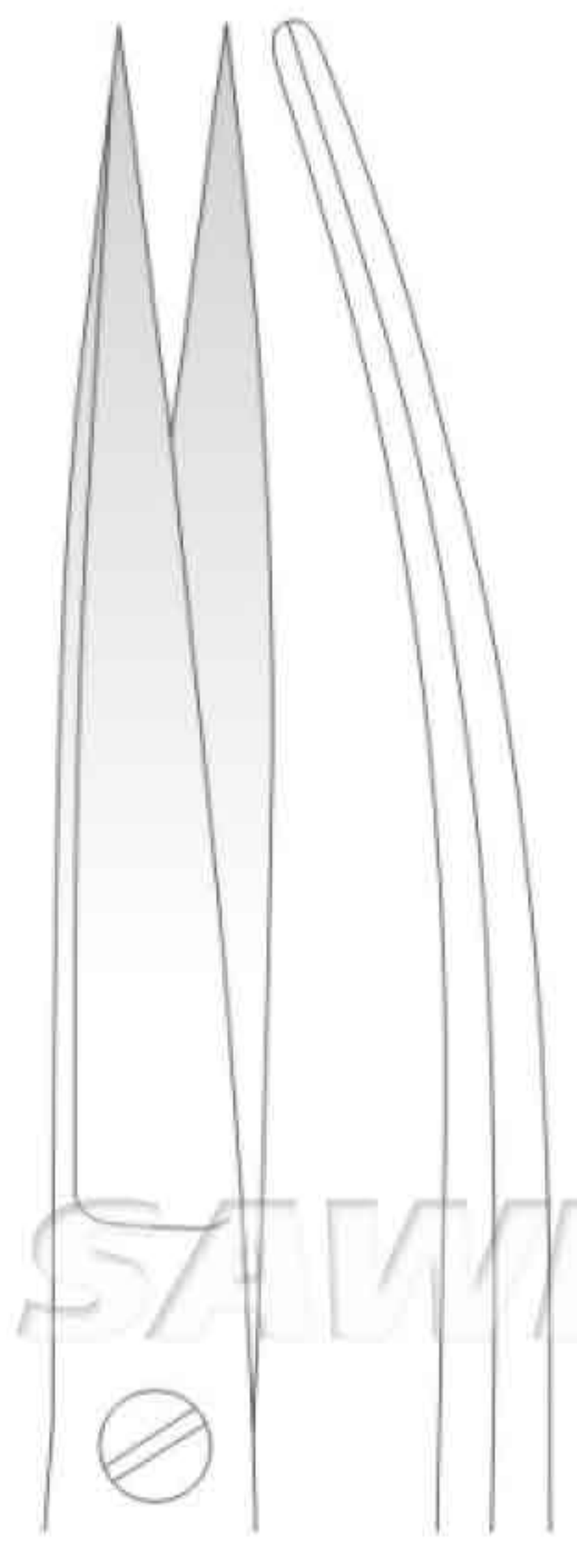
SSC-11-17-80
18.5 cm / 7 1/4"



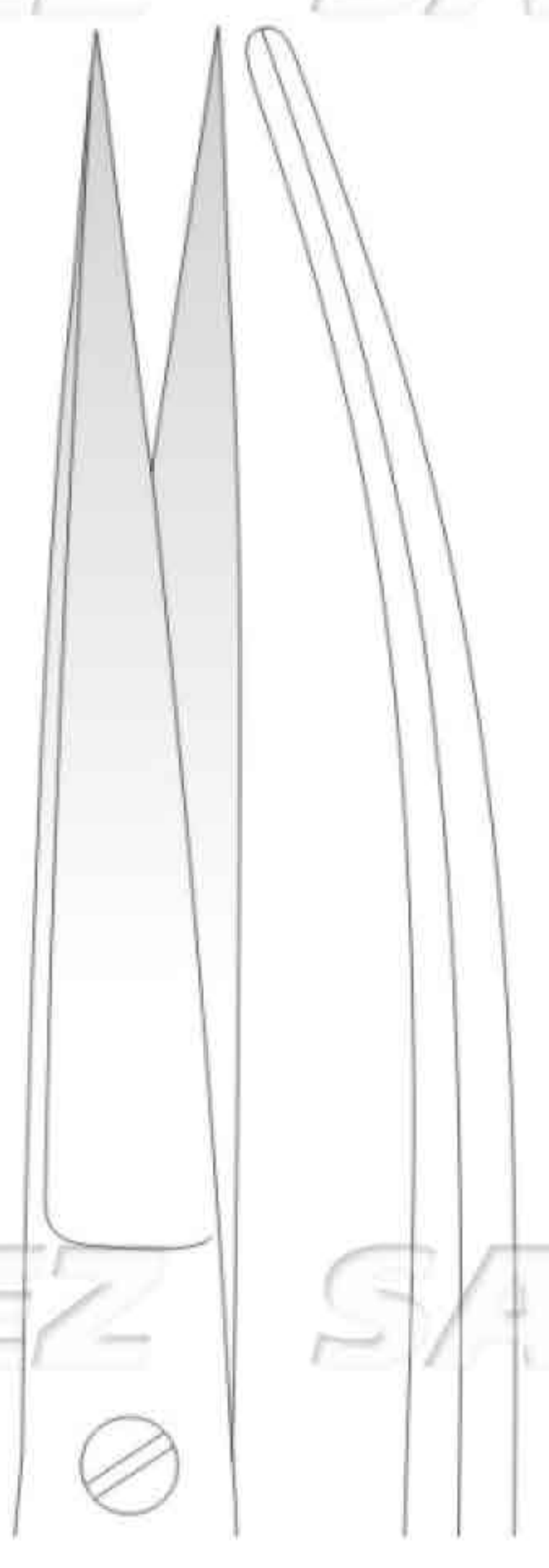
Standard



SSC-11-17-81
14.5 cm / 5 3/4"



SSC-11-17-82
16.5 cm / 6 1/2"



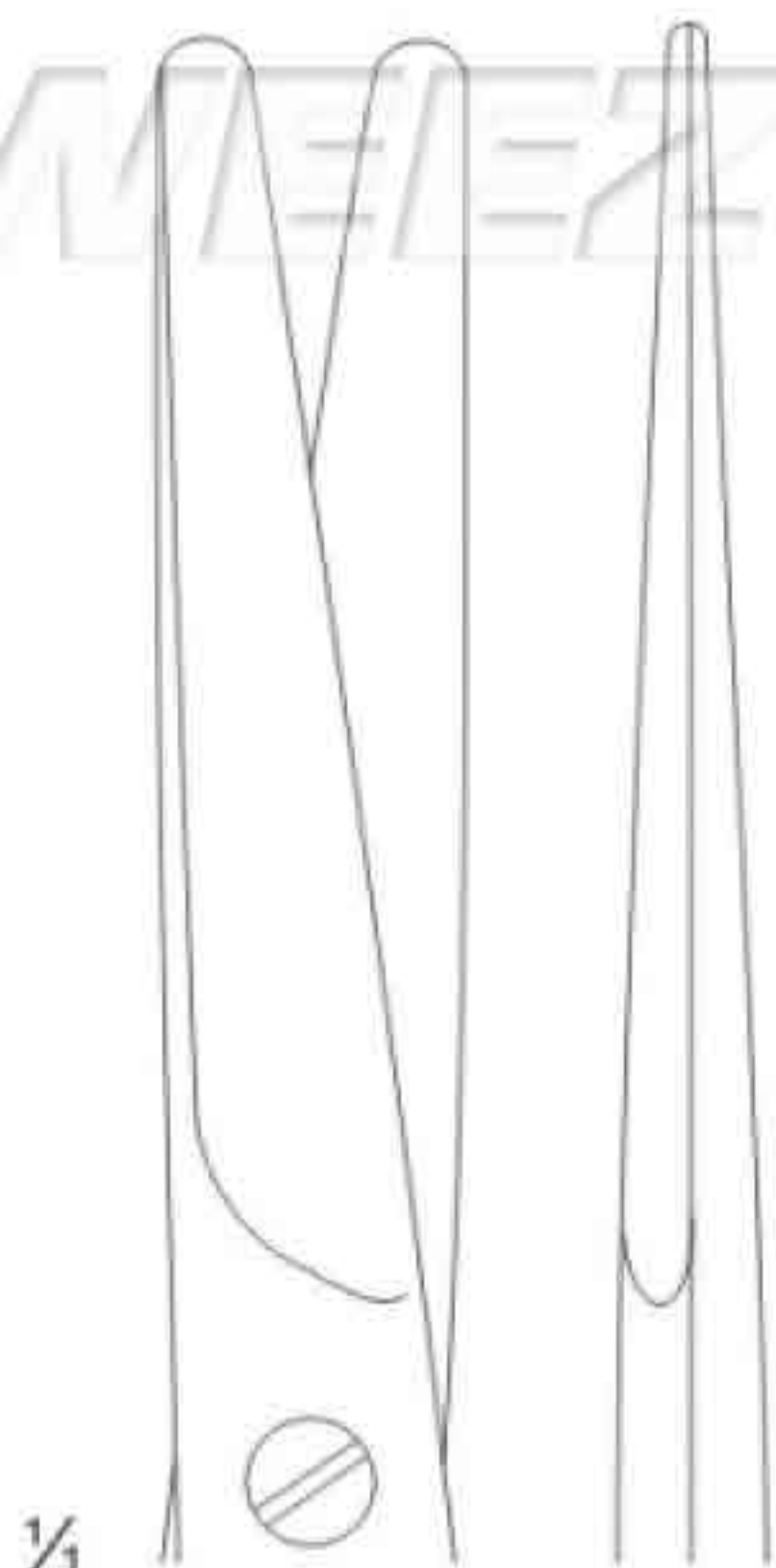
SSC-11-17-83
18.5 cm / 7 1/4"



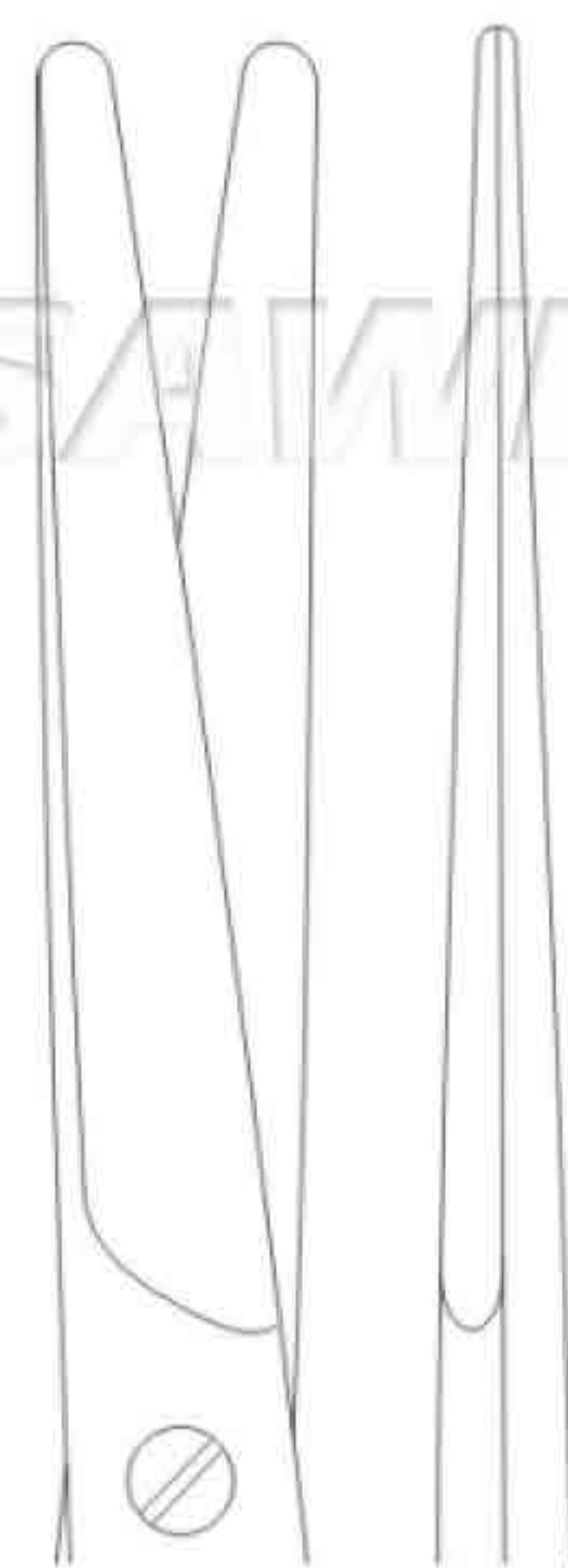
TC GOLD



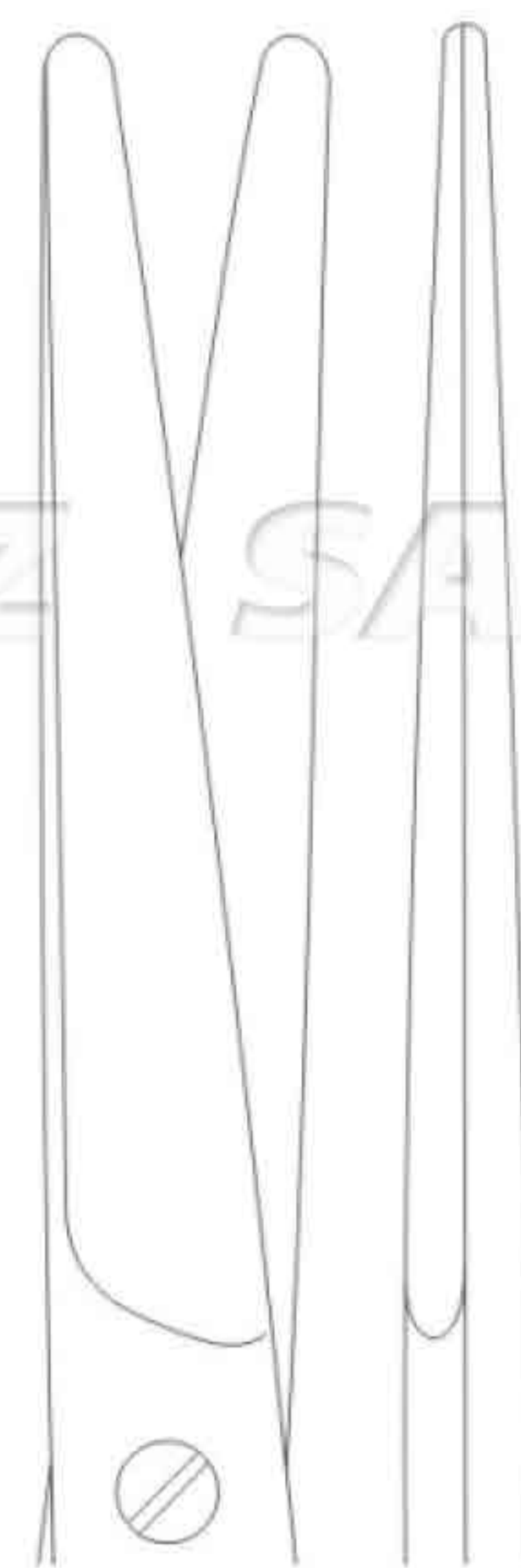
Mayo



SSC-11-17-84
14.5 cm / 5 3/4"



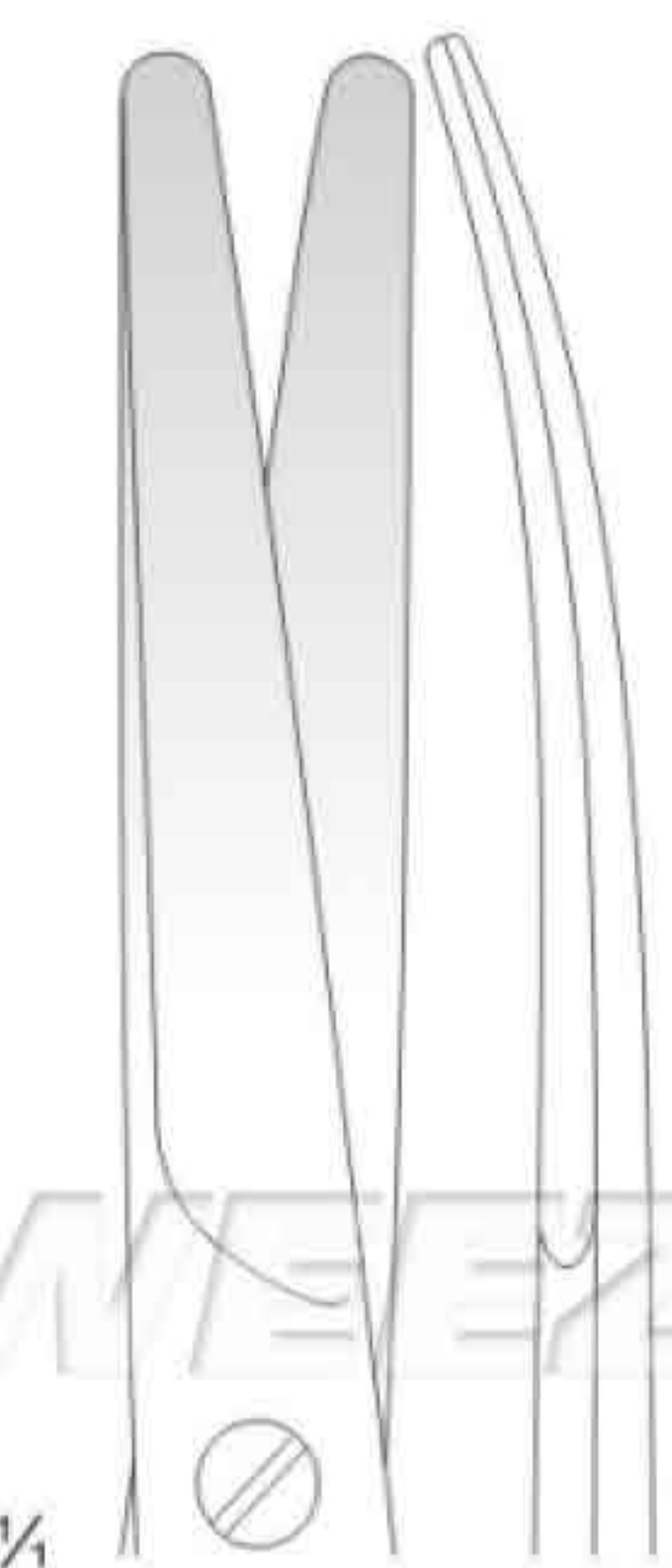
SSC-11-17-85
17.0 cm / 6 3/4"



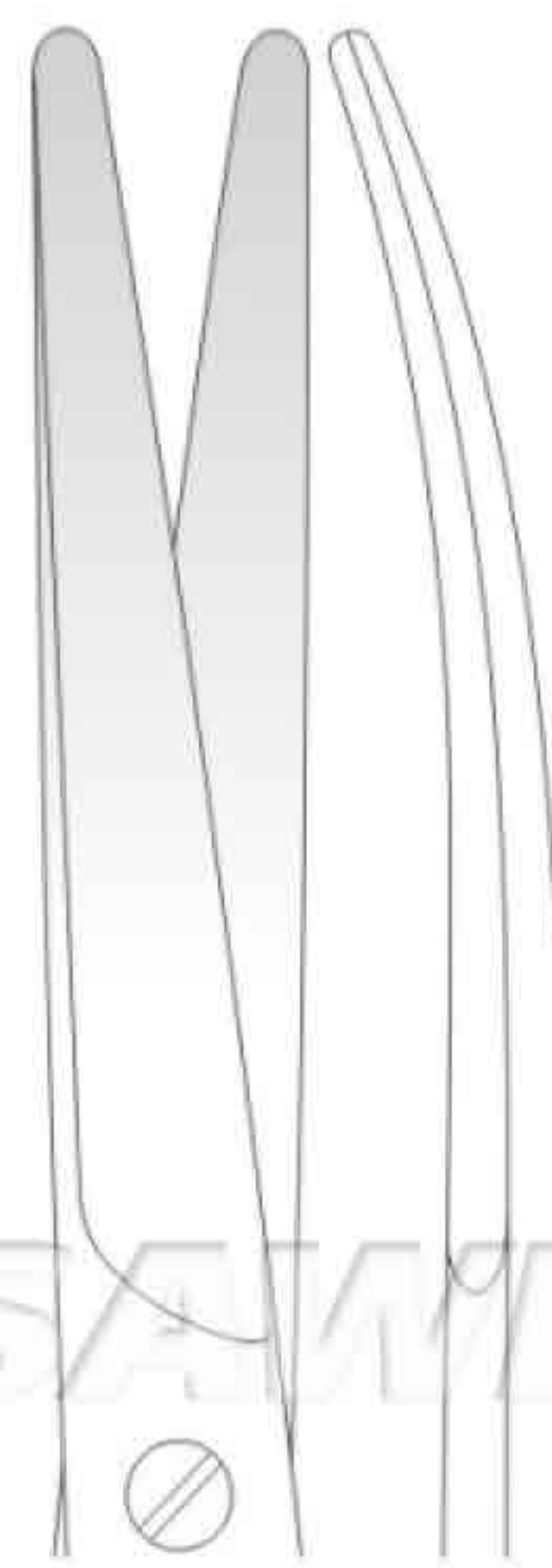
SSC-11-17-86
23.0 cm / 9"



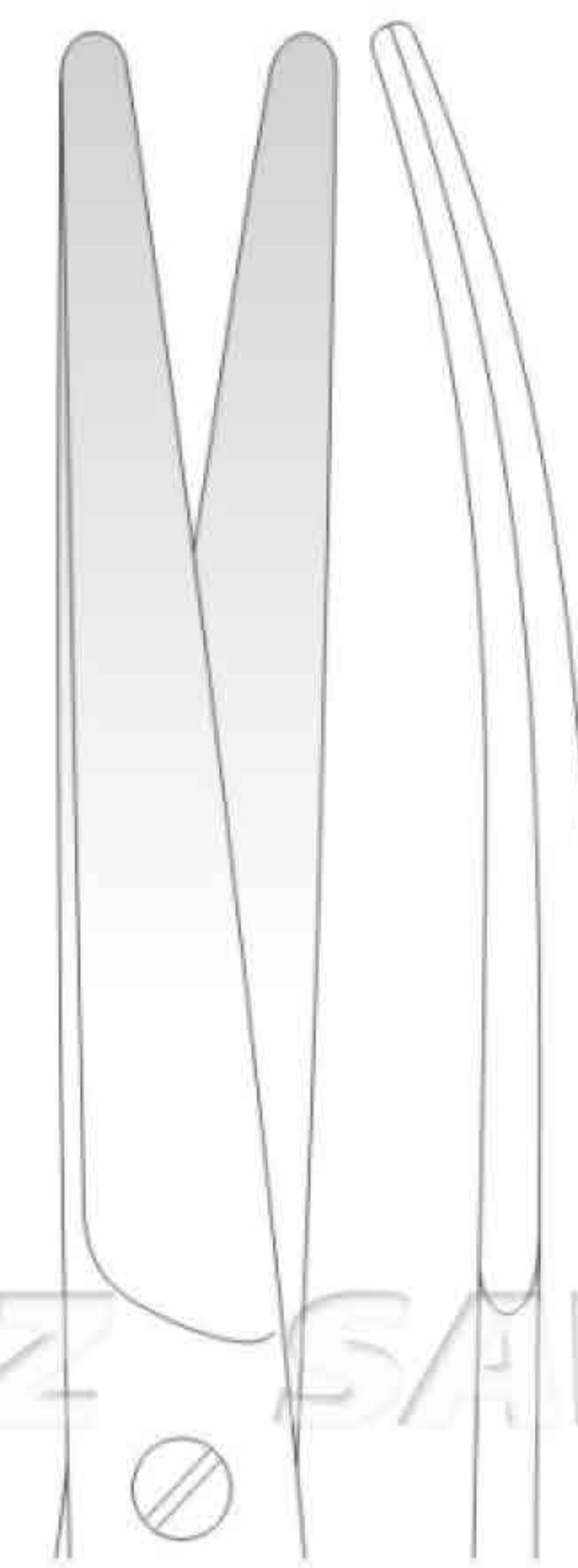
Mayo



SSC-11-17-87
14.5 cm / 5 3/4"



SSC-11-17-88
17.0 cm / 6 3/4"

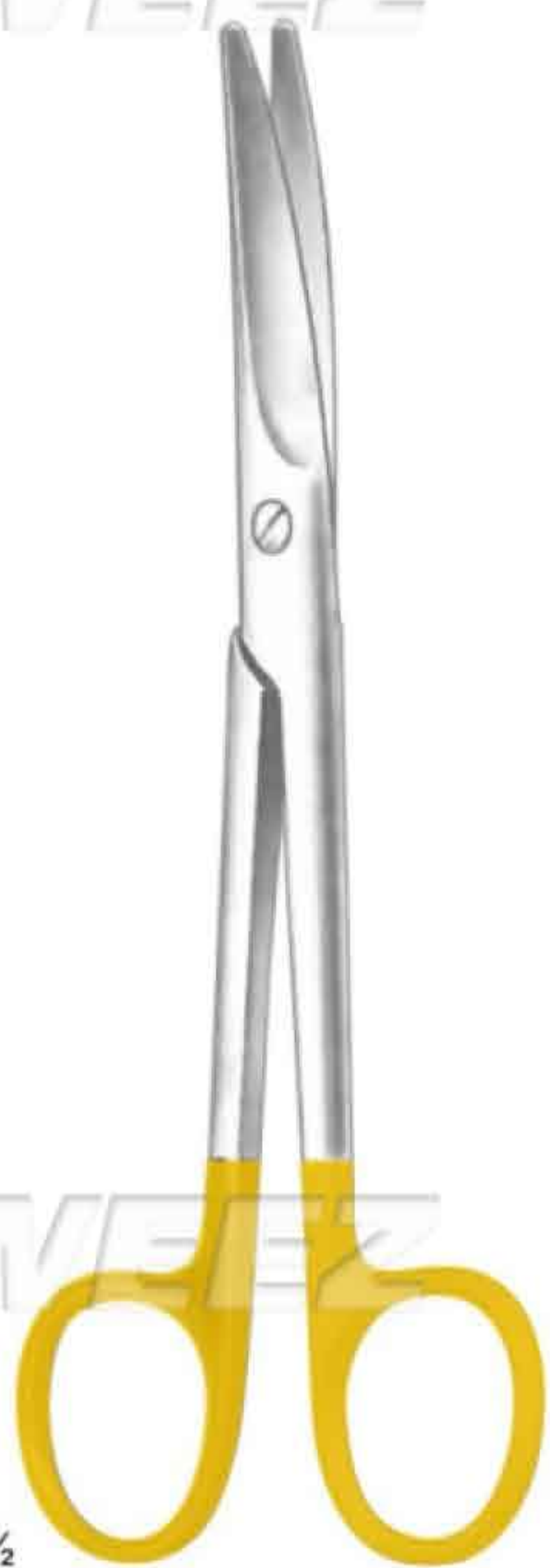


SSC-11-17-89
23.0 cm / 9"



SAWEEZ SAWEEZ SAWEEZ SAWEEZ

SAWEEZ SAWEEZ SAWEEZ SAWEEZ

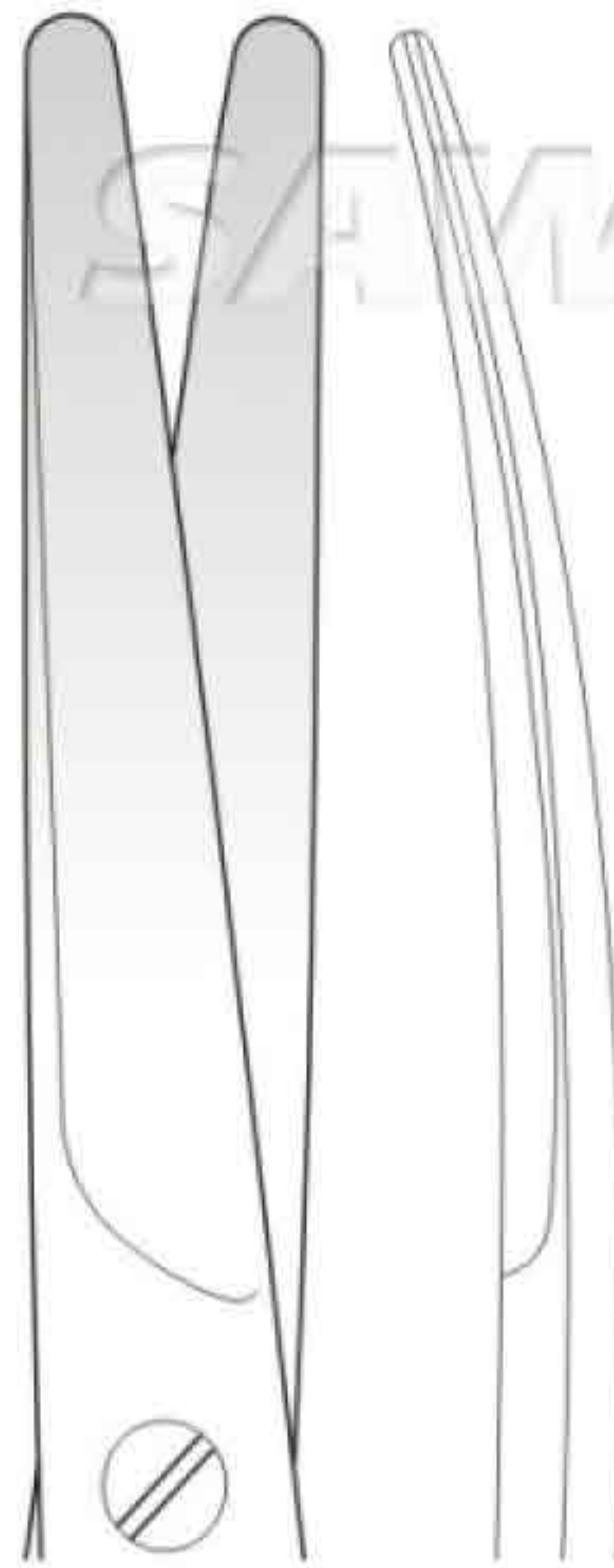


1/2



1/4

SSC-11-17-90
14.0 cm / 5 1/2"



SSC-11-17-91
17.0 cm / 7"



SSC-11-17-92
23.0 cm / 9"

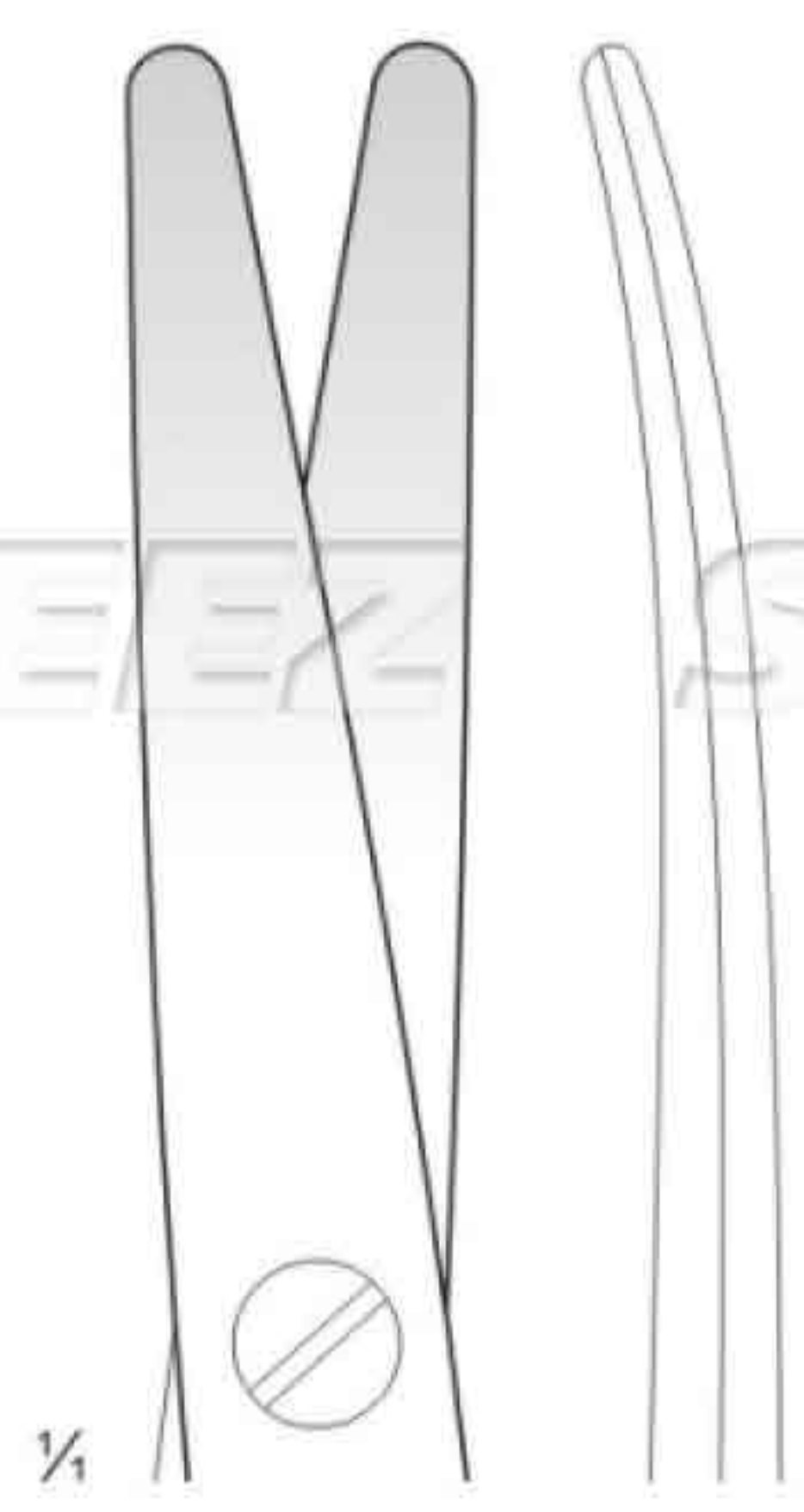
SAWEEZ SAWEEZ SAWEEZ SAWEEZ



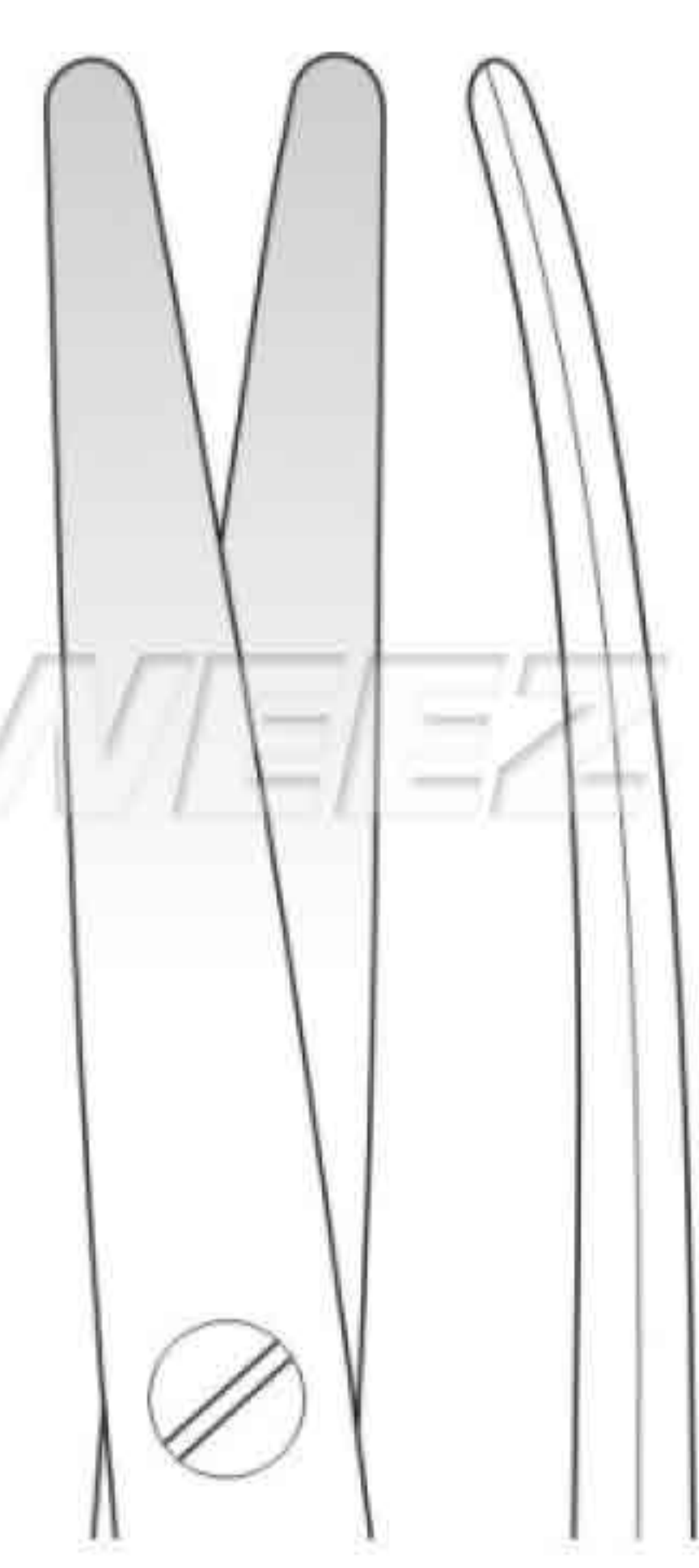
TC GOLD



Mayo-Stille



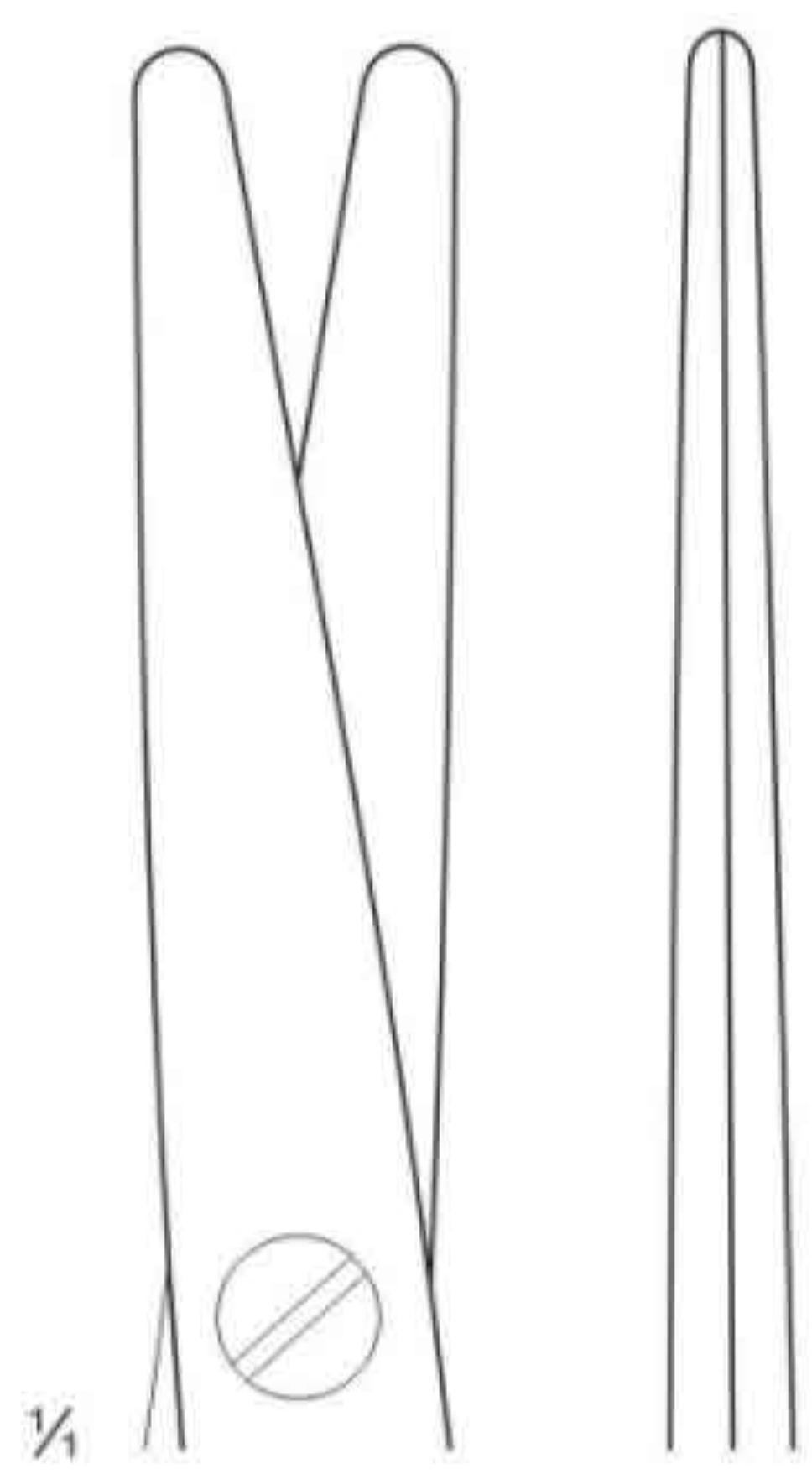
SSC-11-17-93
15.0 cm / 6"



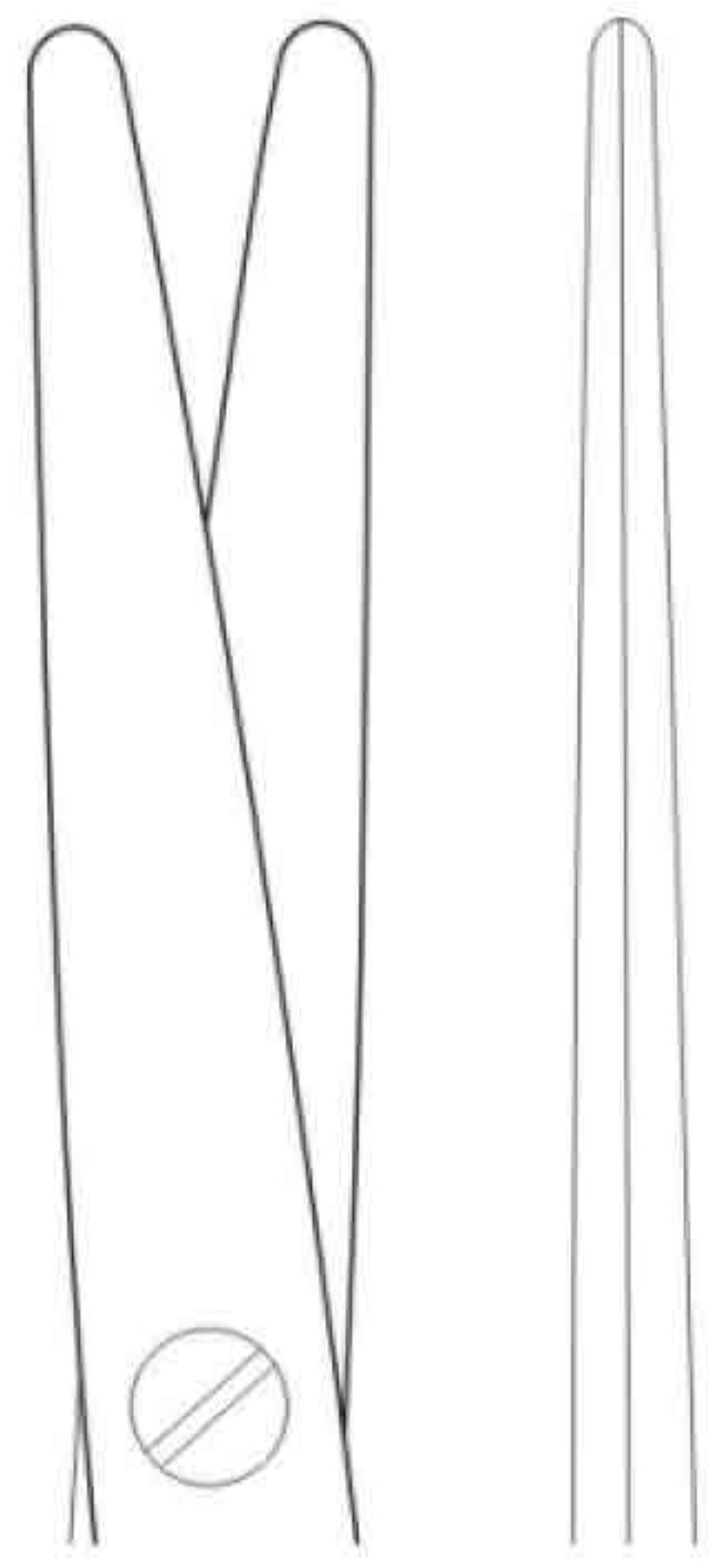
SSC-11-17-94
17.0 cm / 7"



Mayo-Stille



SSC-11-17-95
15.0 cm / 6"



SSC-11-17-96
17.0 cm / 7"



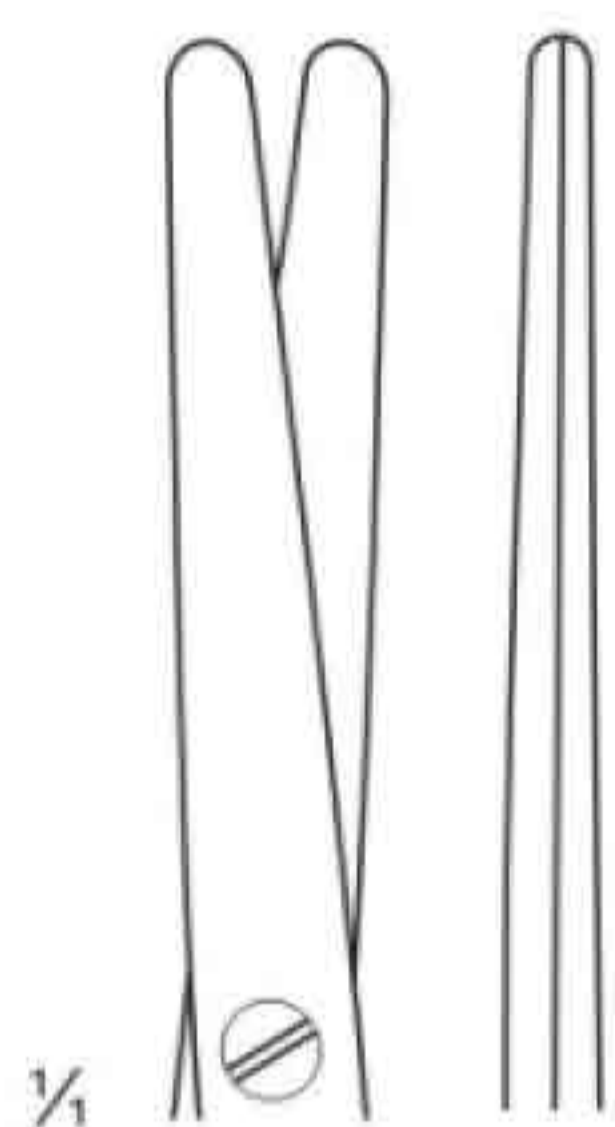
TC GOLD

SAWEEZ SAWEEZ SAWEEZ SAWEEZ



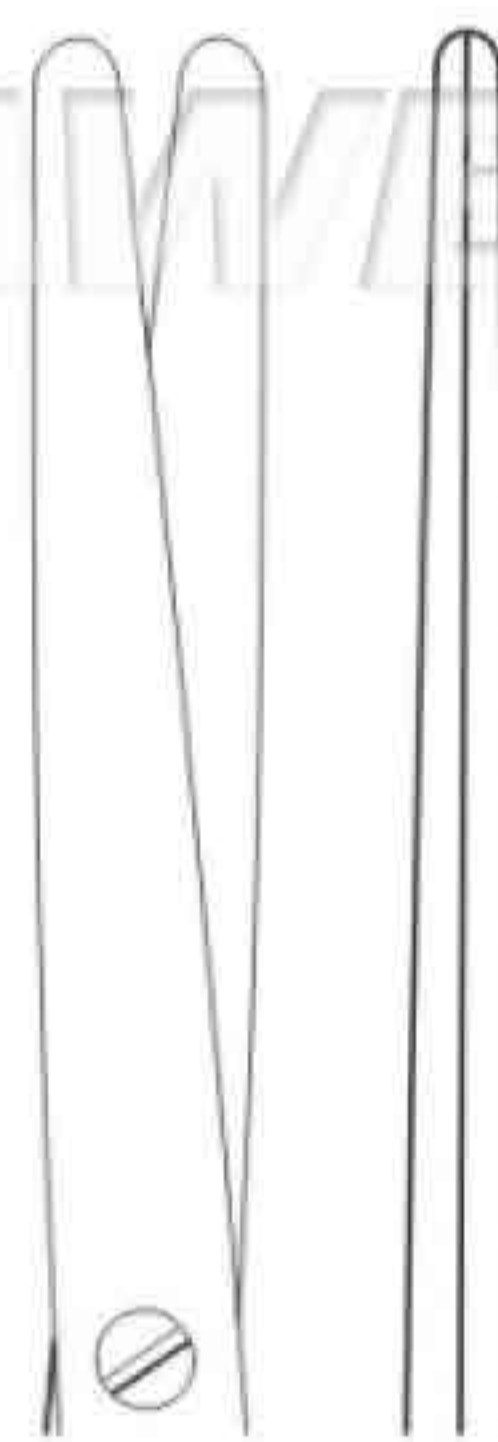
1/2

Metzenbaum



1/4

SSC-11-17-97
11.5 cm / 4 1/2"



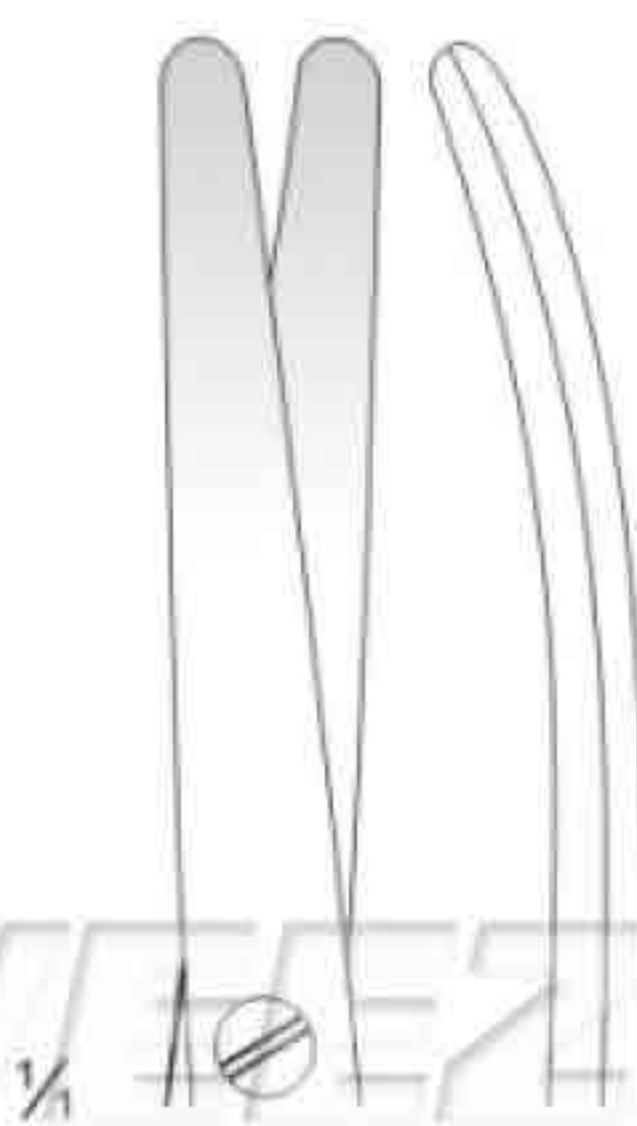
SSC-11-17-98
14.5 cm / 5 3/4"

SAWEEZ SAWEEZ SAWEEZ SAWEEZ



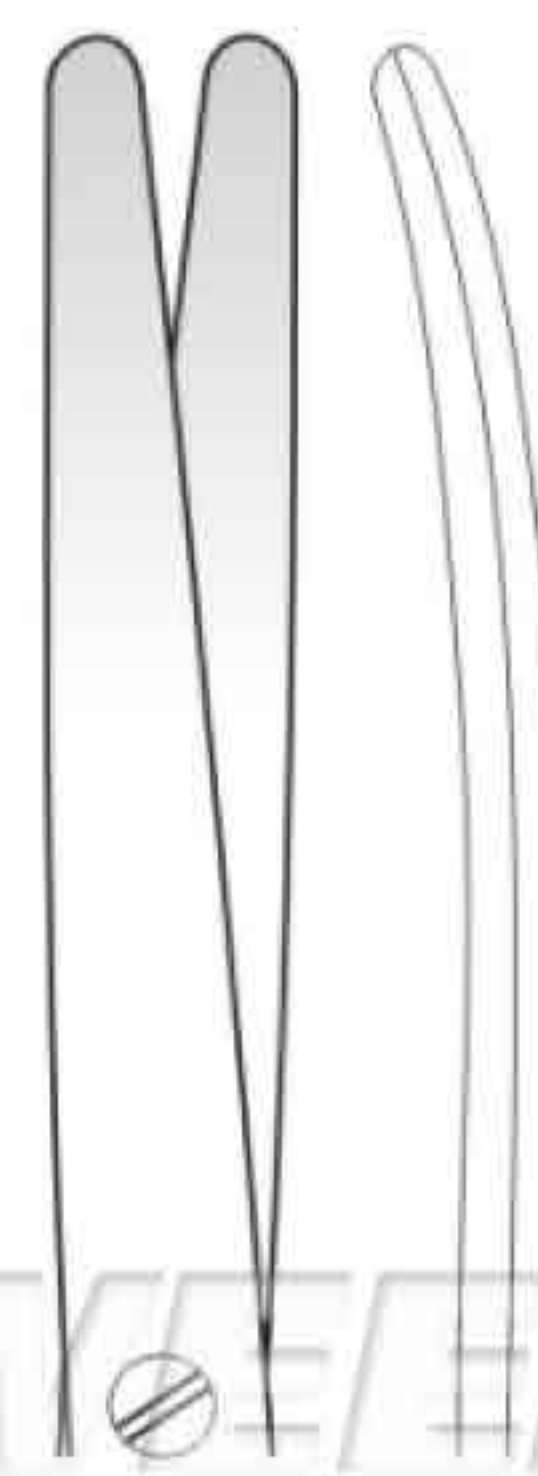
1/2

Metzenbaum



1/4

SSC-11-17-99
11.5 cm / 4 1/2"



SSC-11-18-00
14.5 cm / 5 3/4"

SAWEEZ SAWEEZ SAWEEZ SAWEEZ



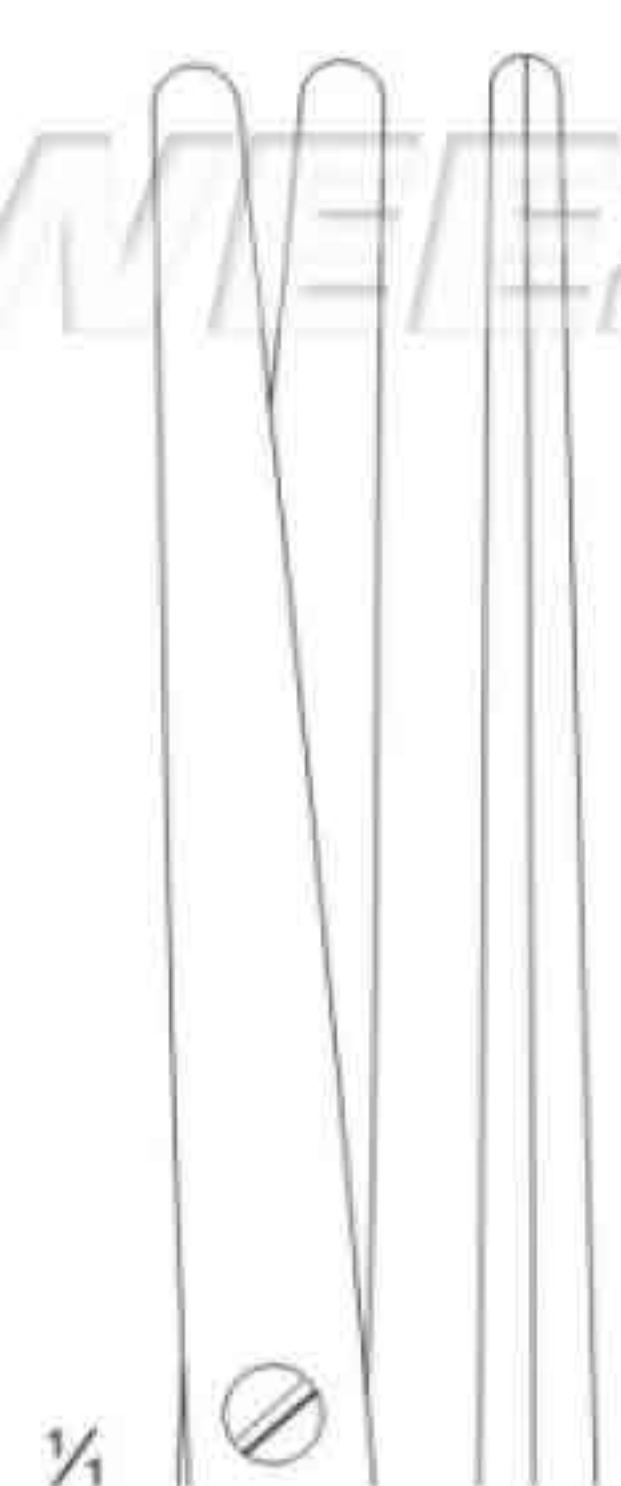
TC / GOLD

SAWEEZ

SAWEEZ

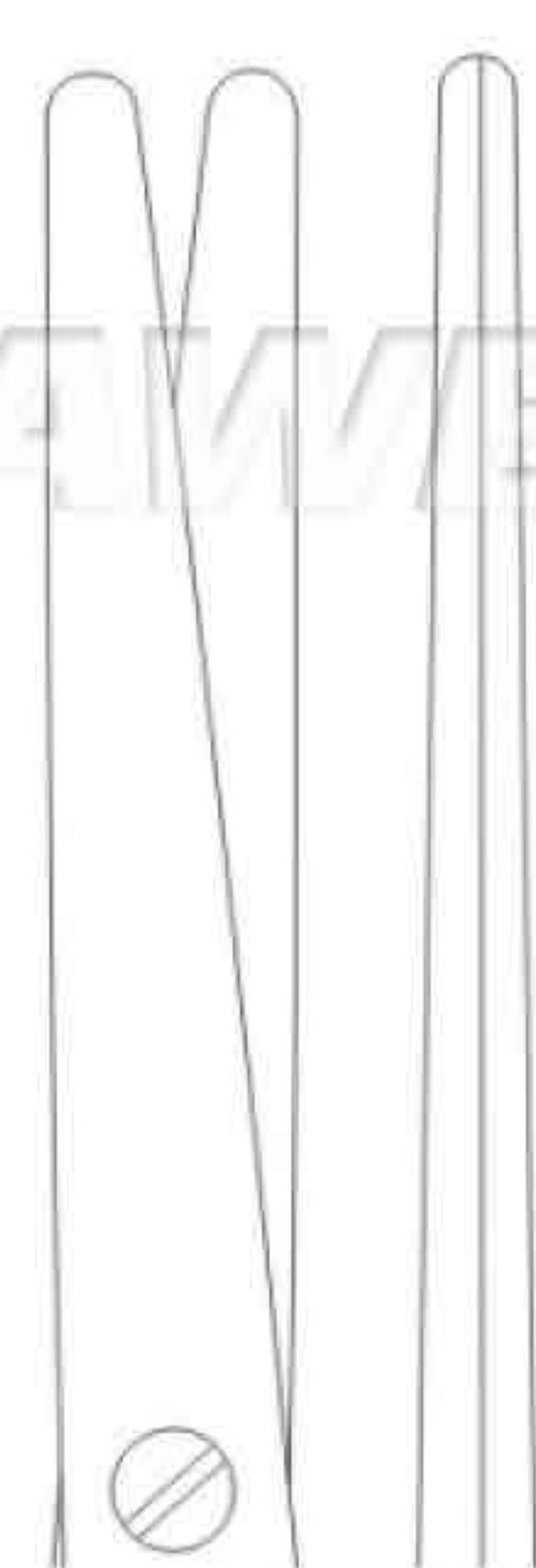
SAWEEZ

SAWEEZ



1/4

SSC-11-18-01
18.0 cm / 7"



SSC-11-18-02
20.0 cm / 8"



SSC-11-18-03
23.0 cm / 9"

SAWEEZ

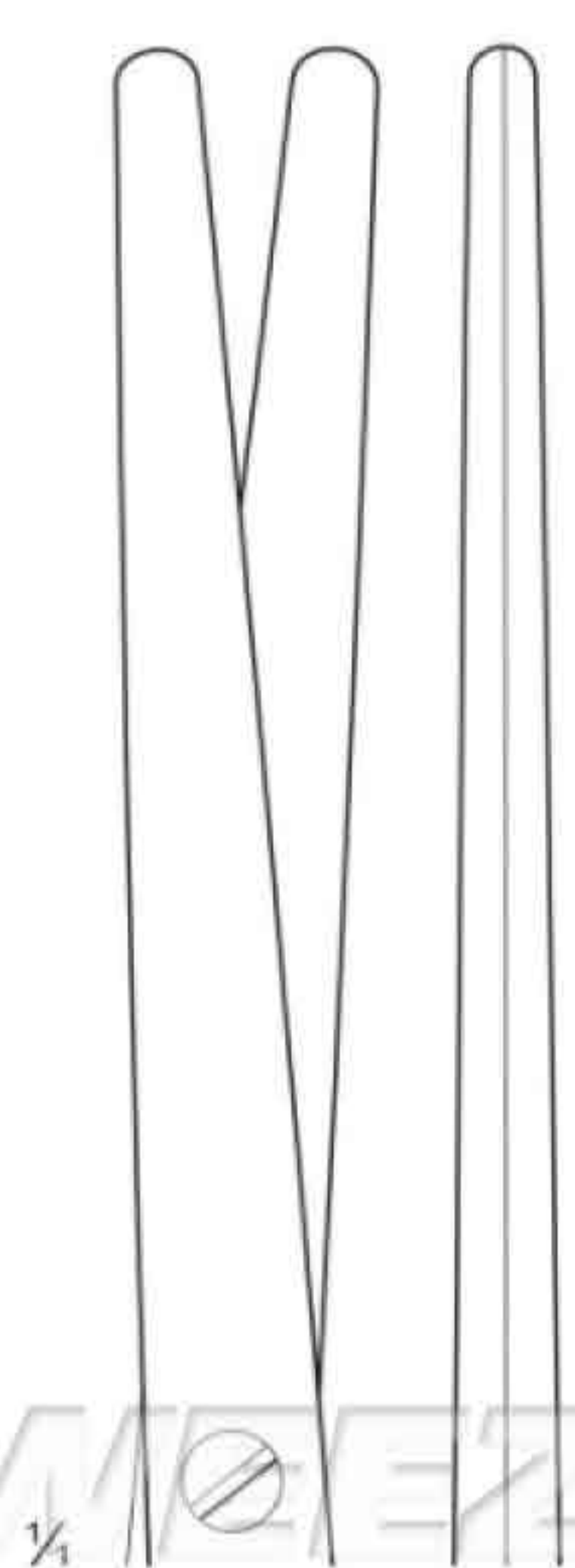
SAWEEZ

SAWEEZ

SAWEEZ

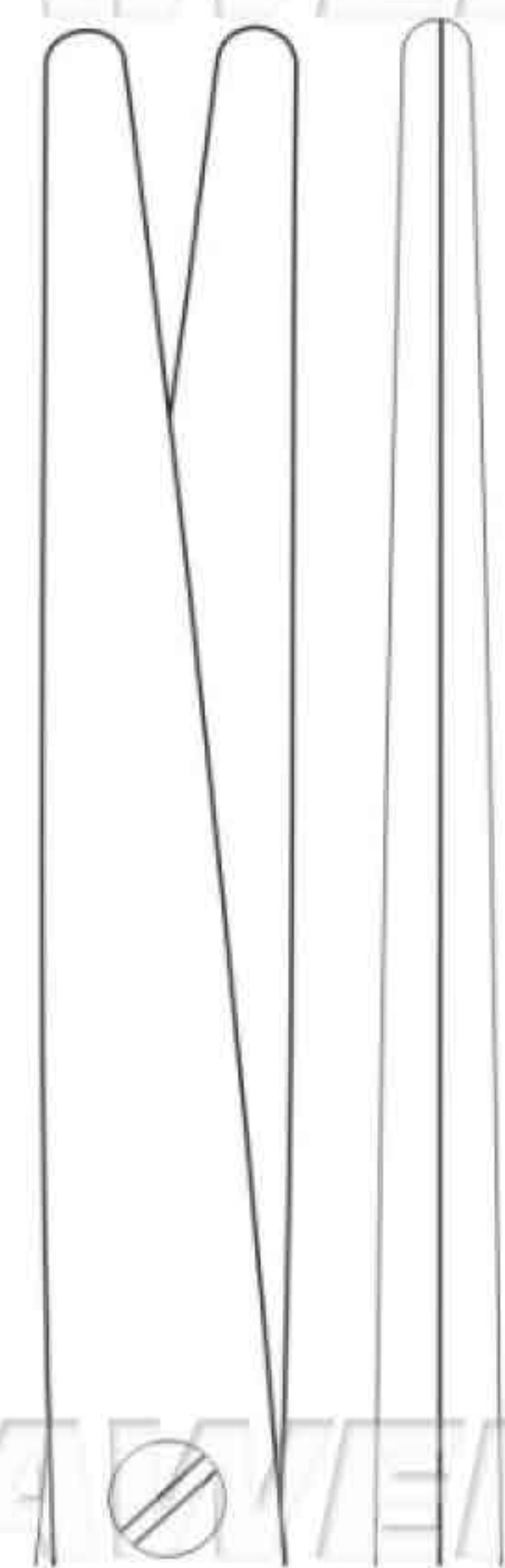


Metzenbaum

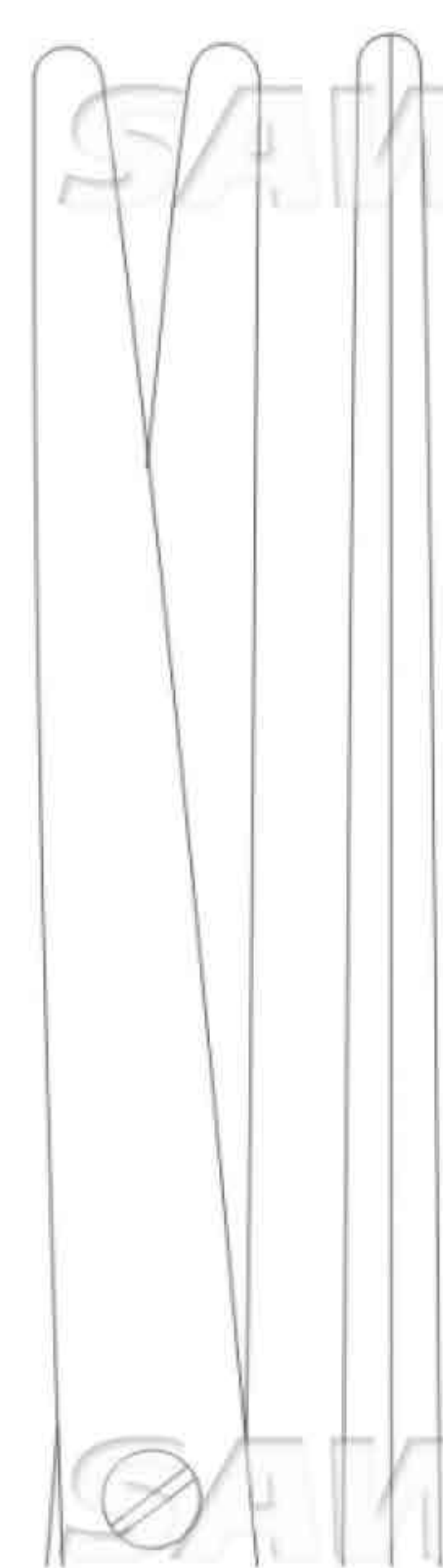


1/4

SSC-11-18-04
25.0 cm / 10"



SSC-11-18-05
28.0 cm / 11"



SSC-11-18-06
30.0 cm / 12"

SAWEEZ

SAWEEZ

SAWEEZ

SAWEEZ



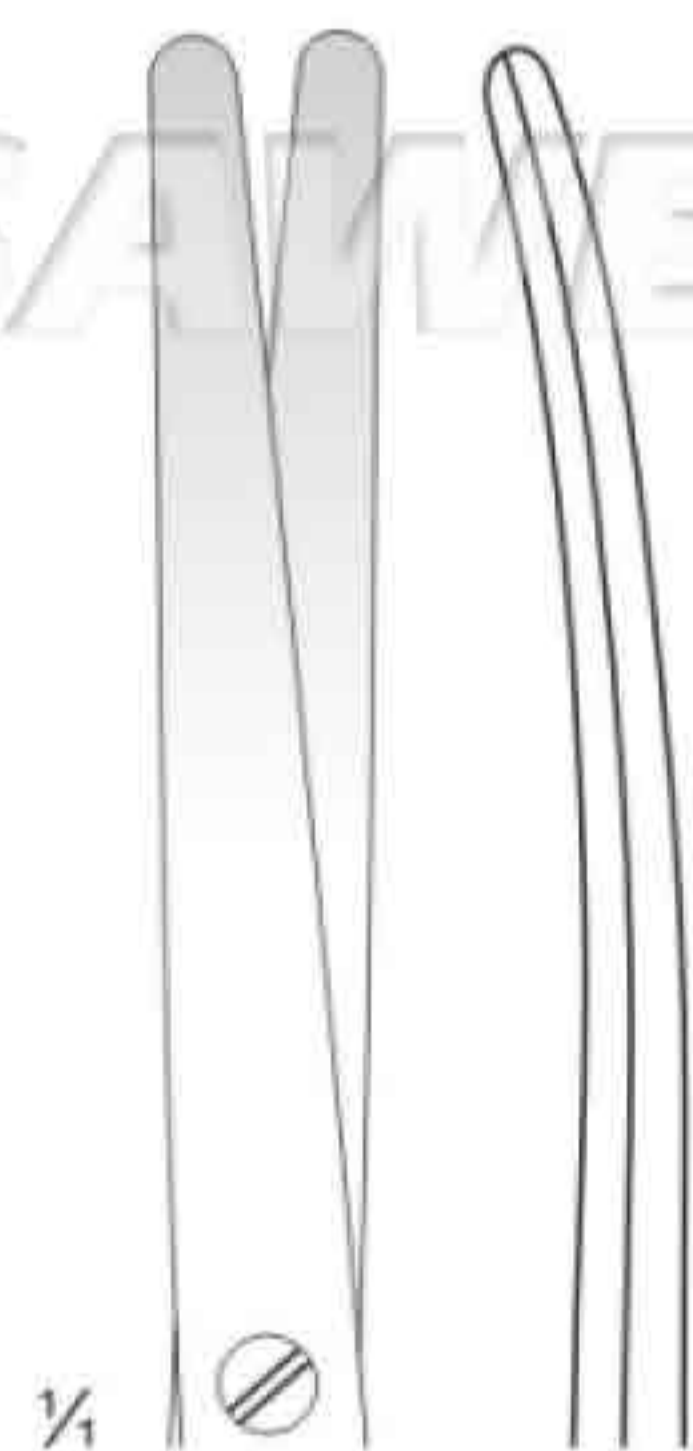
TC / GOLD

SAWEEZ

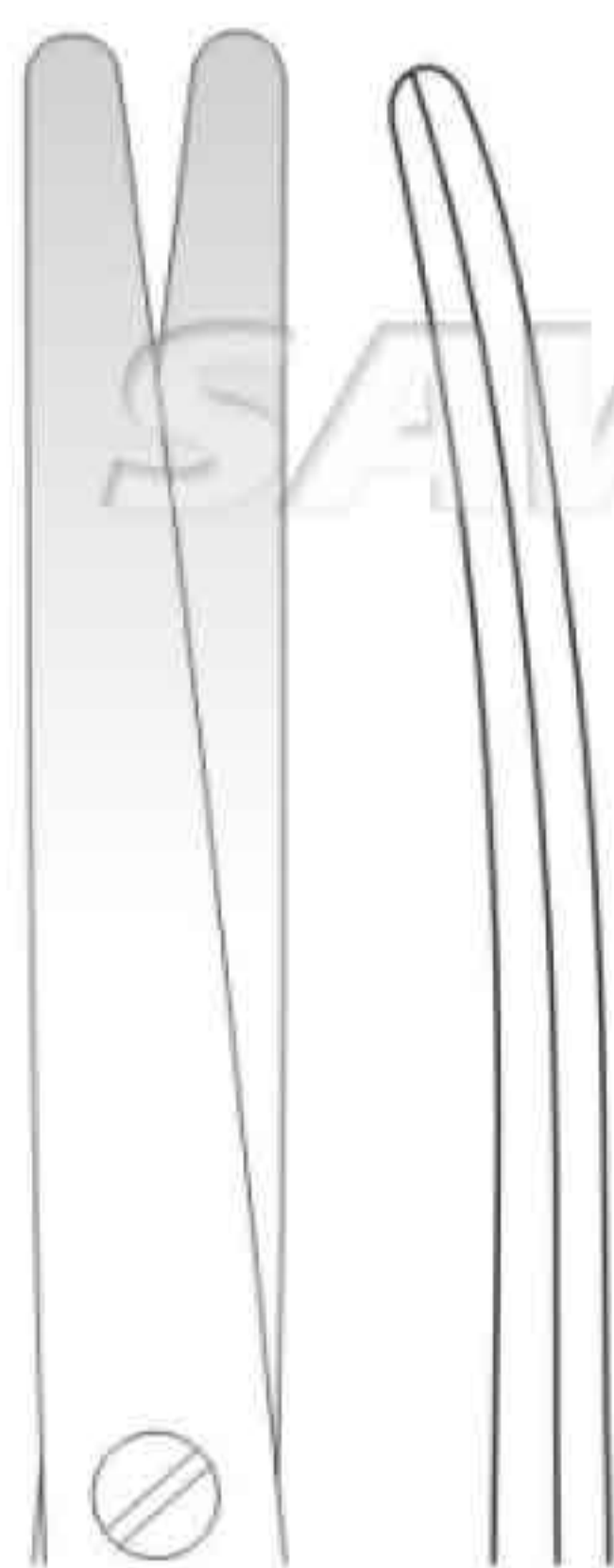
SAWEEZ

SAWEEZ

SAWEEZ



SSC-11-18-07
18.0 cm / 7"



SSC-11-18-08
20.0 cm / 8"



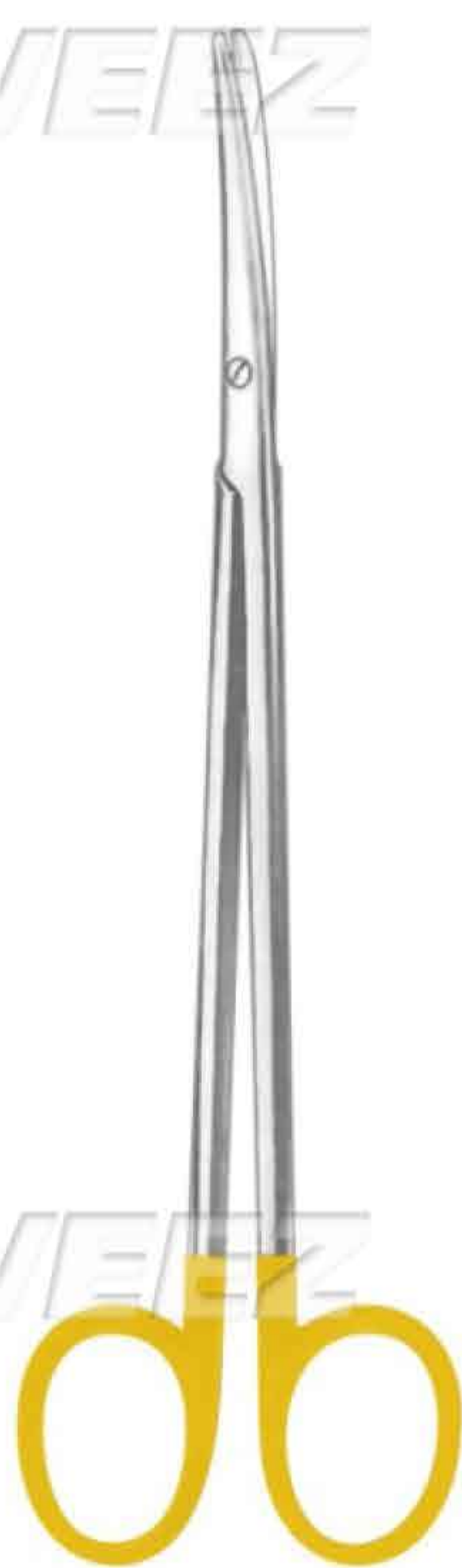
SSC-11-18-09
23.0 cm / 9"

SAWEEZ

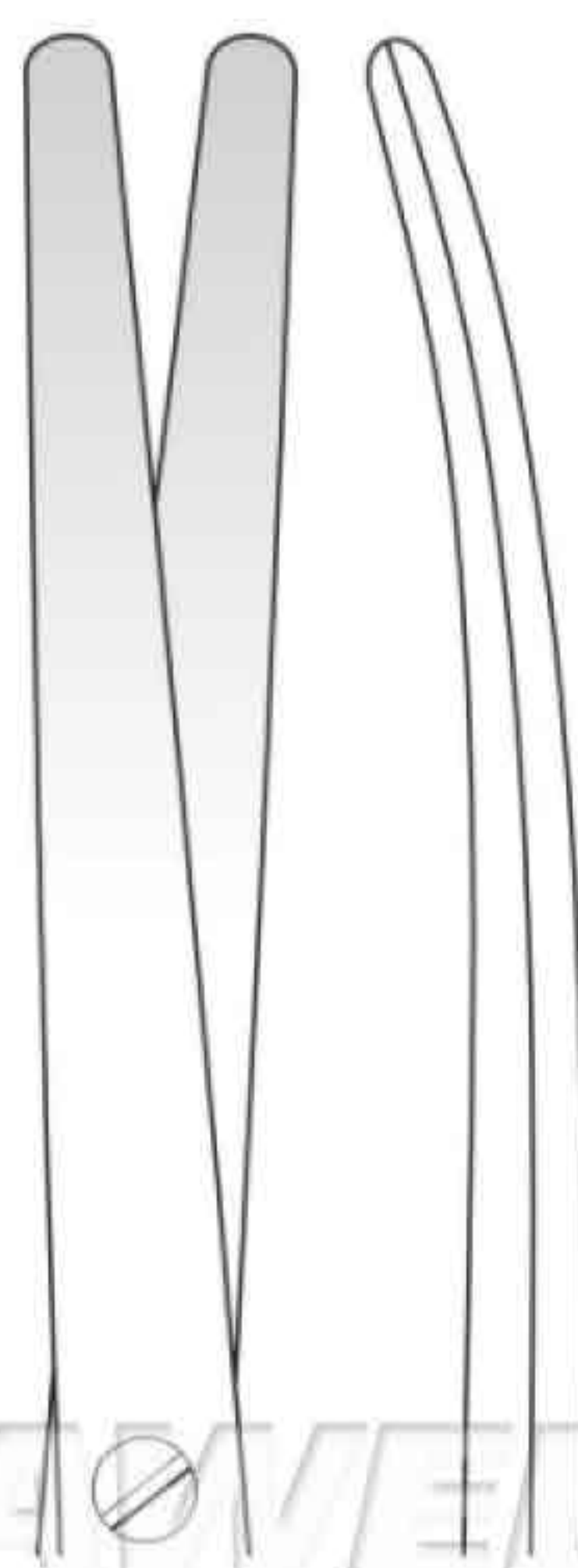
SAWEEZ

SAWEEZ

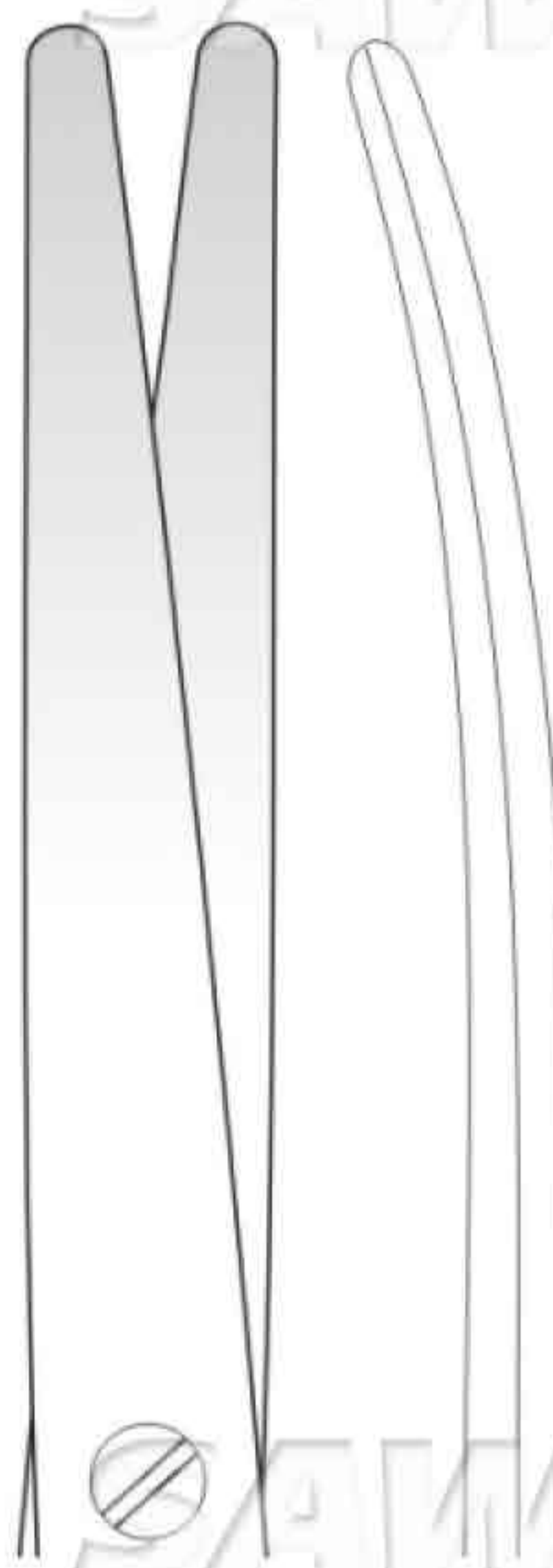
SAWEEZ



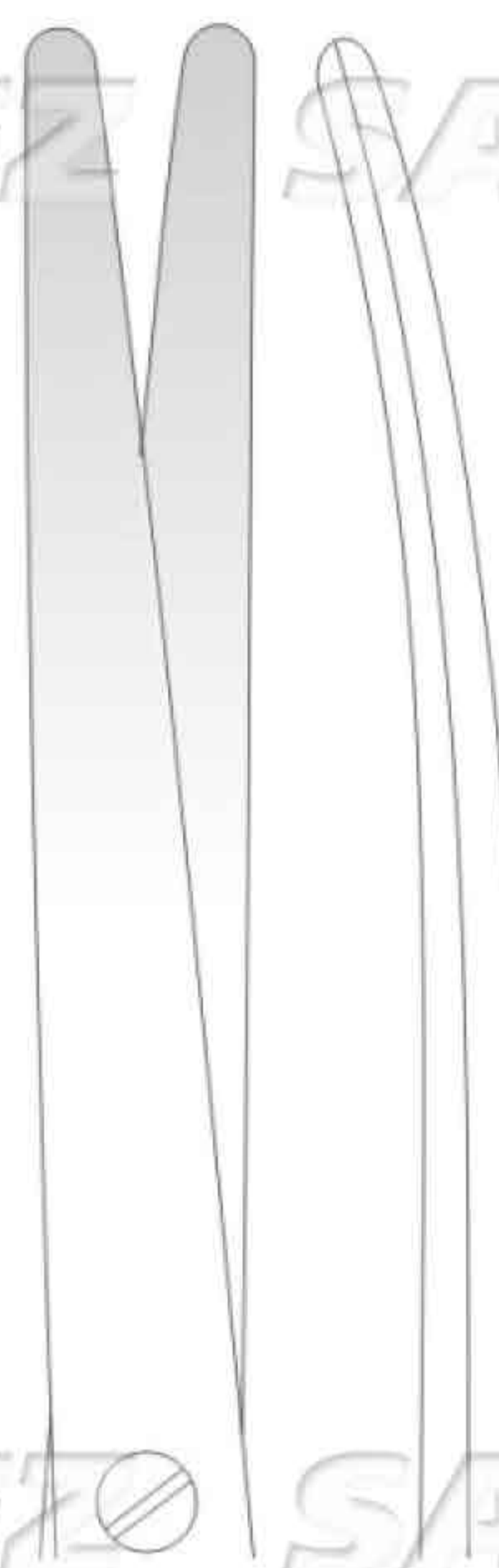
Metzenbaum



SSC-11-18-10
25.0 cm / 10"



SSC-11-18-11
28.0 cm / 11"



SSC-11-18-12
30.0 cm / 12"

SAWEEZ

SAWEEZ

SAWEEZ

SAWEEZ



TC GOLD

SAWEEZ SAWEEZ

SAWEEZ SAWEEZ



SSC-11-18-13
14.0 cm / 5 1/2"

Metzenbaum-Lahey

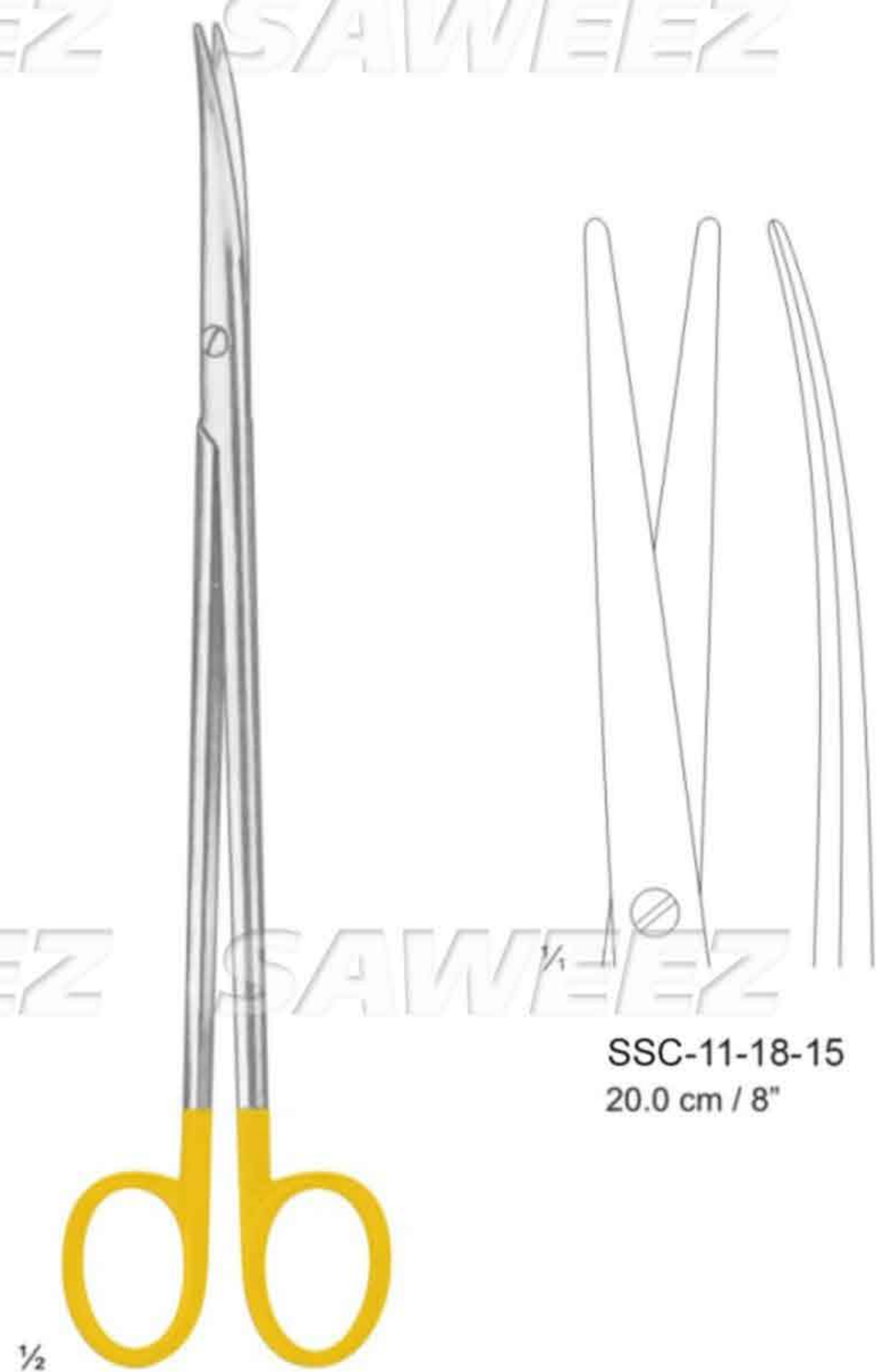


SSC-11-18-14
17.0 cm / 7"

Toennis-Adson

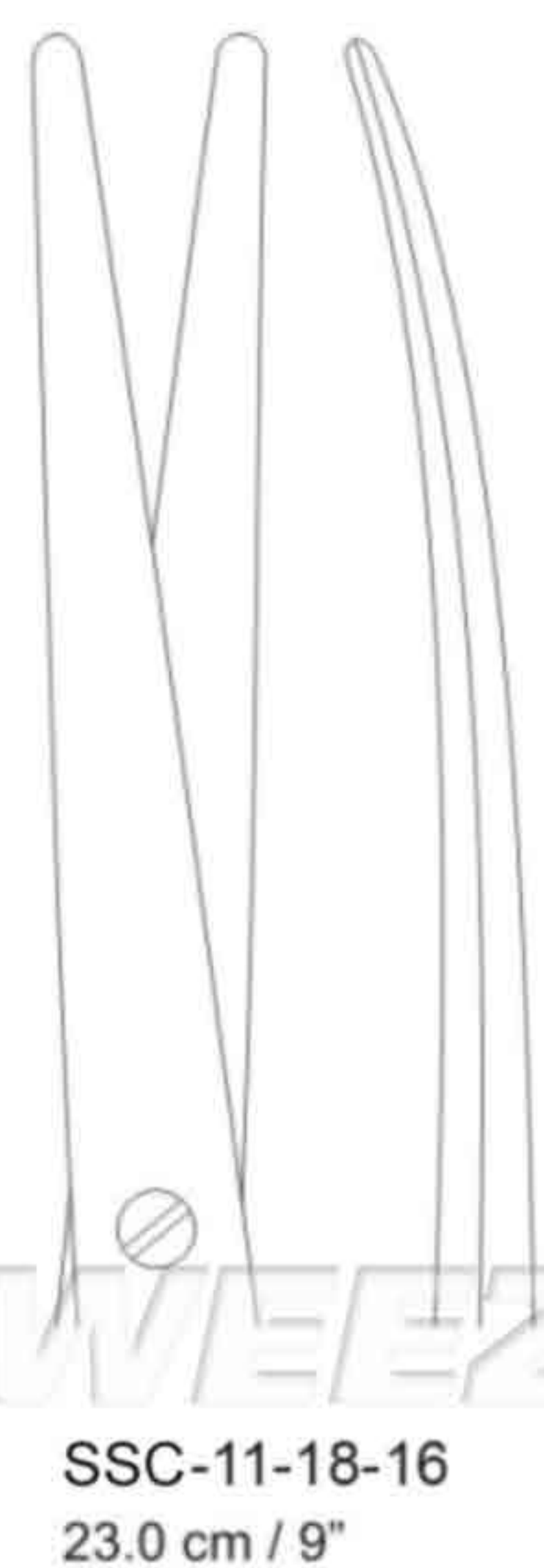
SAWEEZ SAWEEZ

SAWEEZ SAWEEZ



SSC-11-18-15
20.0 cm / 8"

Metzenbaum



SSC-11-18-16
23.0 cm / 9"

SAWEEZ SAWEEZ

SAWEEZ SAWEEZ



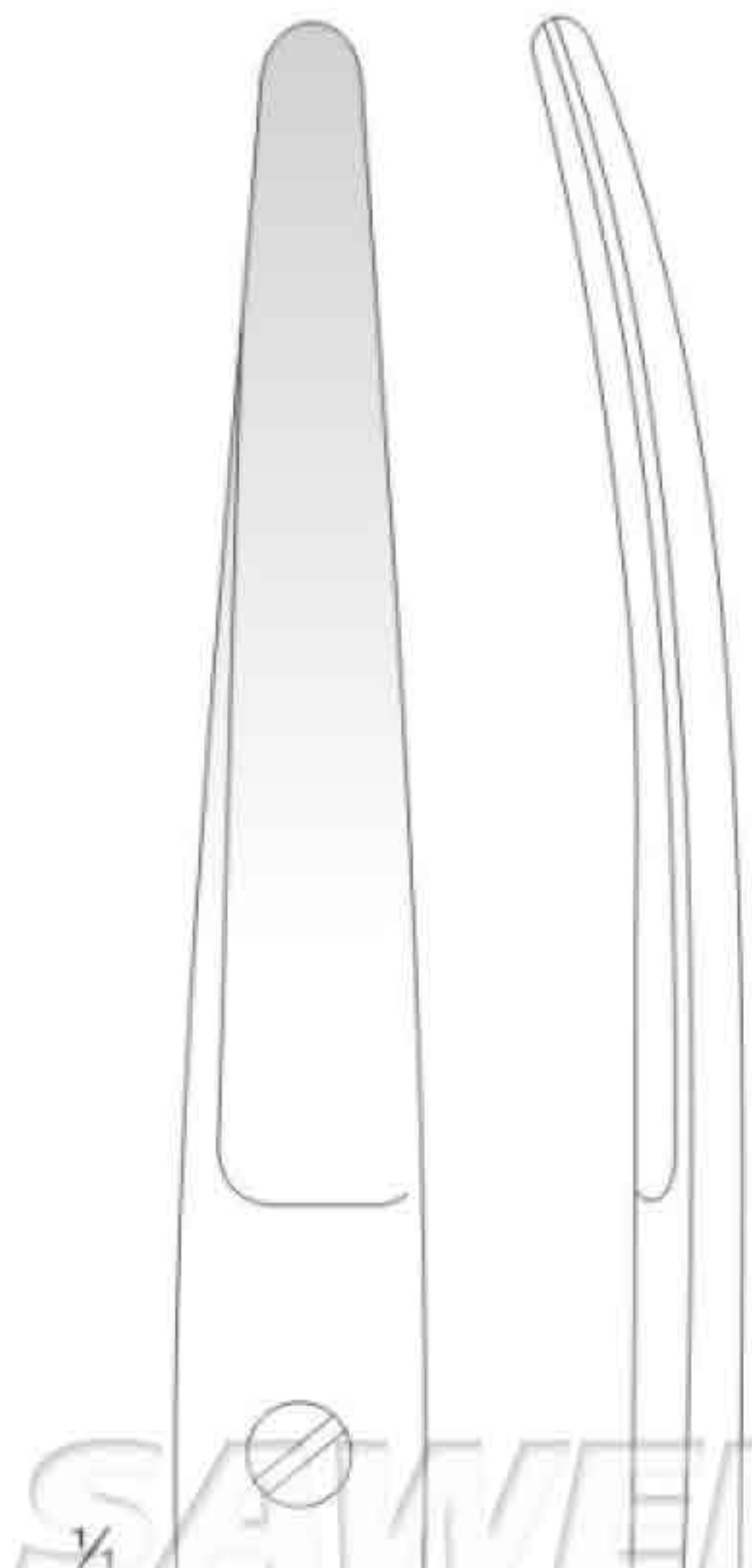
TC / GOLD

SAWEEZ SAWEEZ SAWEEZ SAWEEZ



1/2

Mayo-Harrington



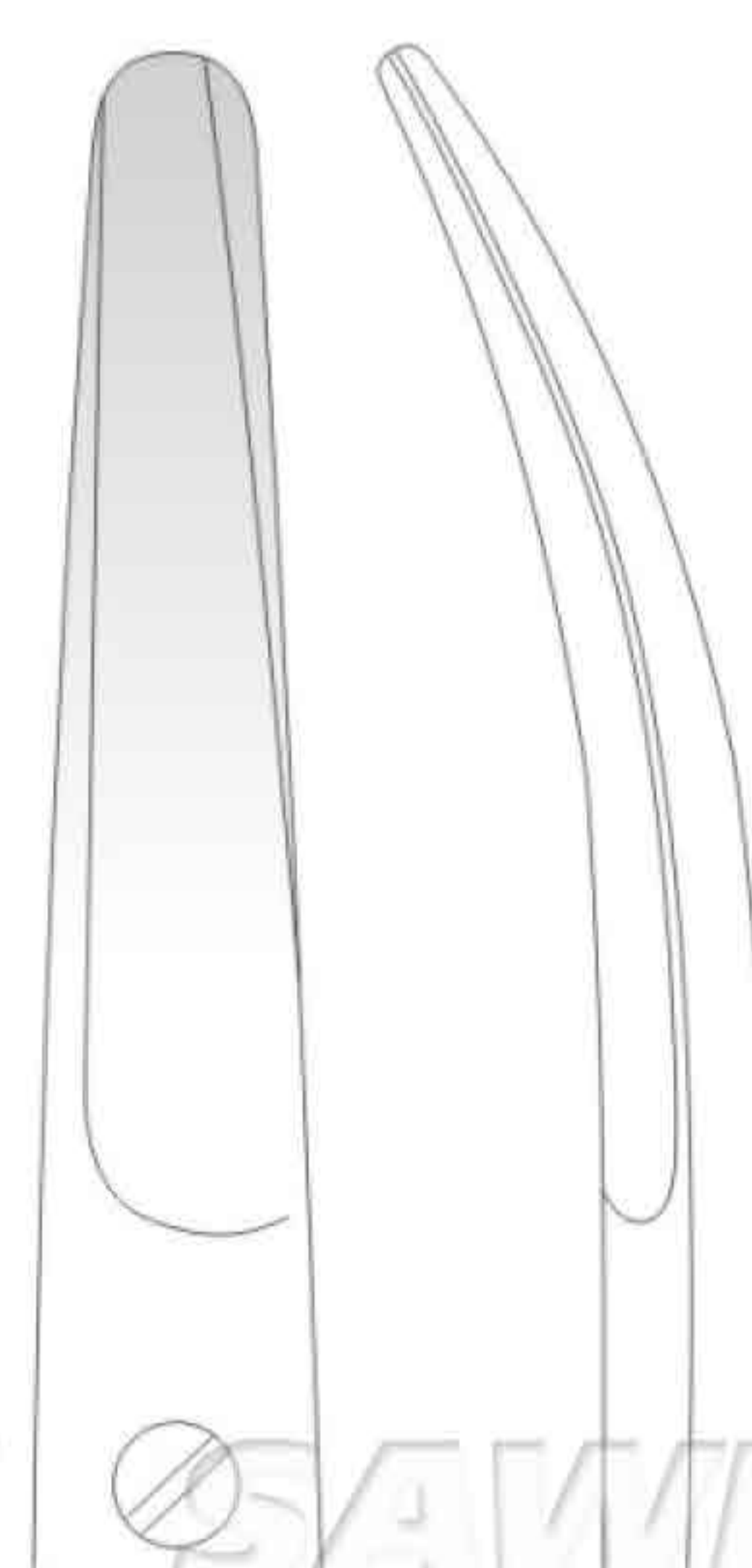
1/4

SSC-11-18-17
28.0 cm / 11"



1/2

Sims



1/4

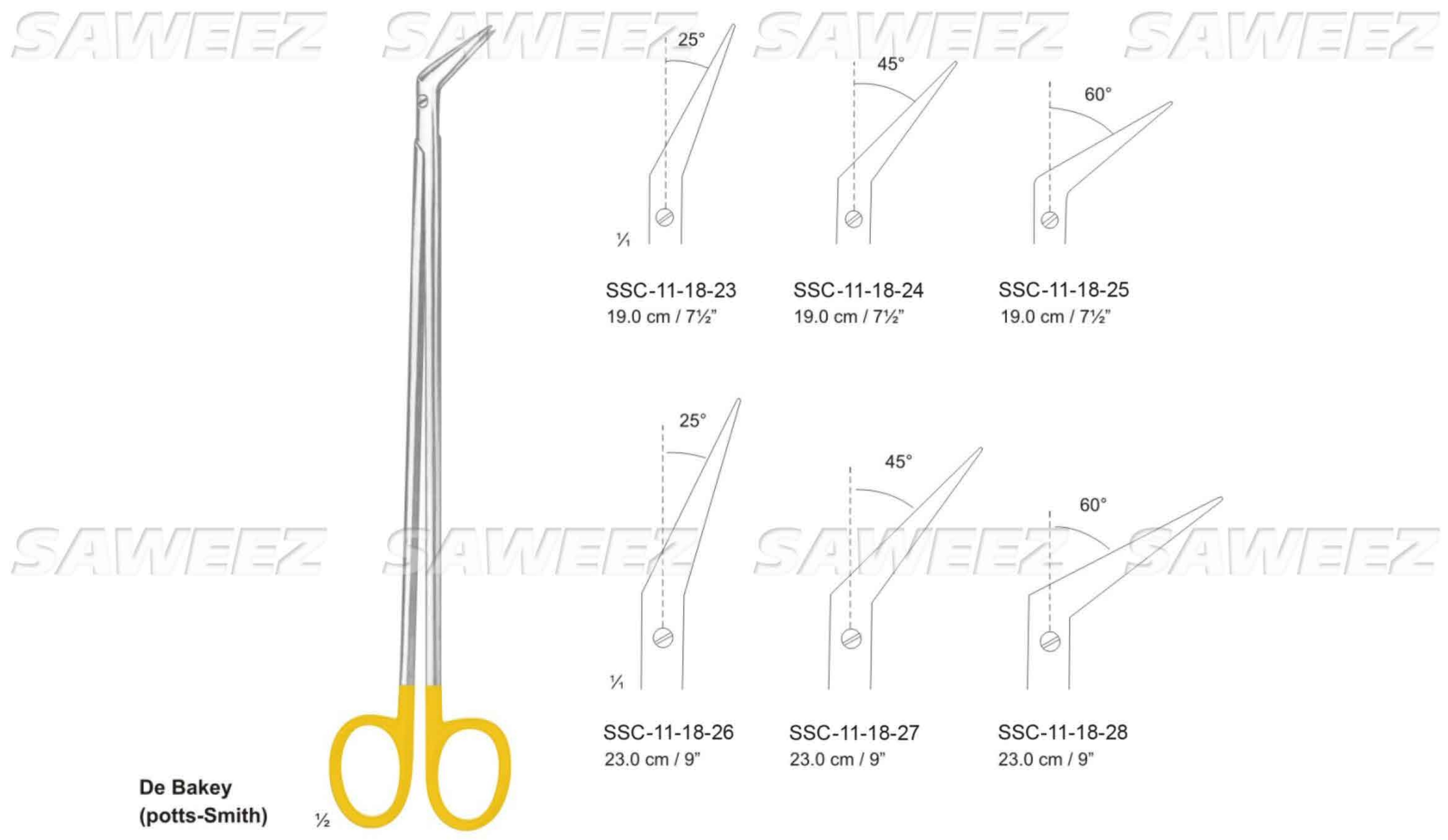
SSC-11-18-18
23.0 cm / 9"

SAWEEZ SAWEEZ SAWEEZ SAWEEZ

SAWEEZ SAWEEZ SAWEEZ SAWEEZ



TC GOLD

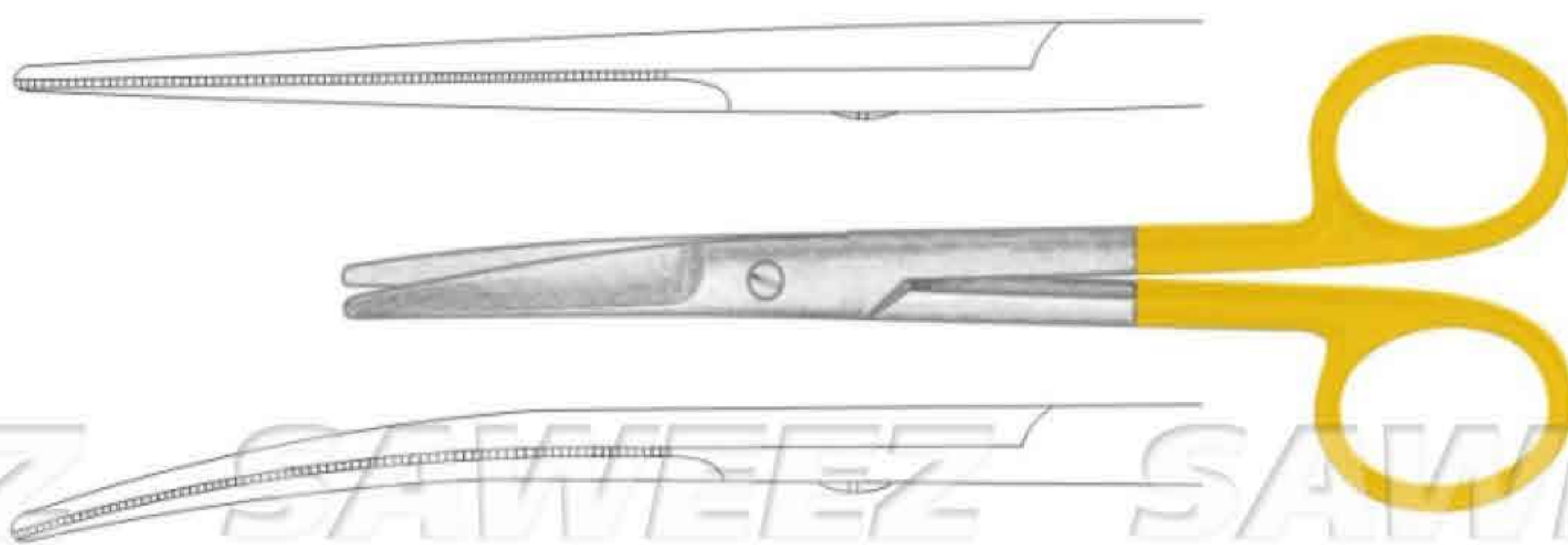




TC / GOLD

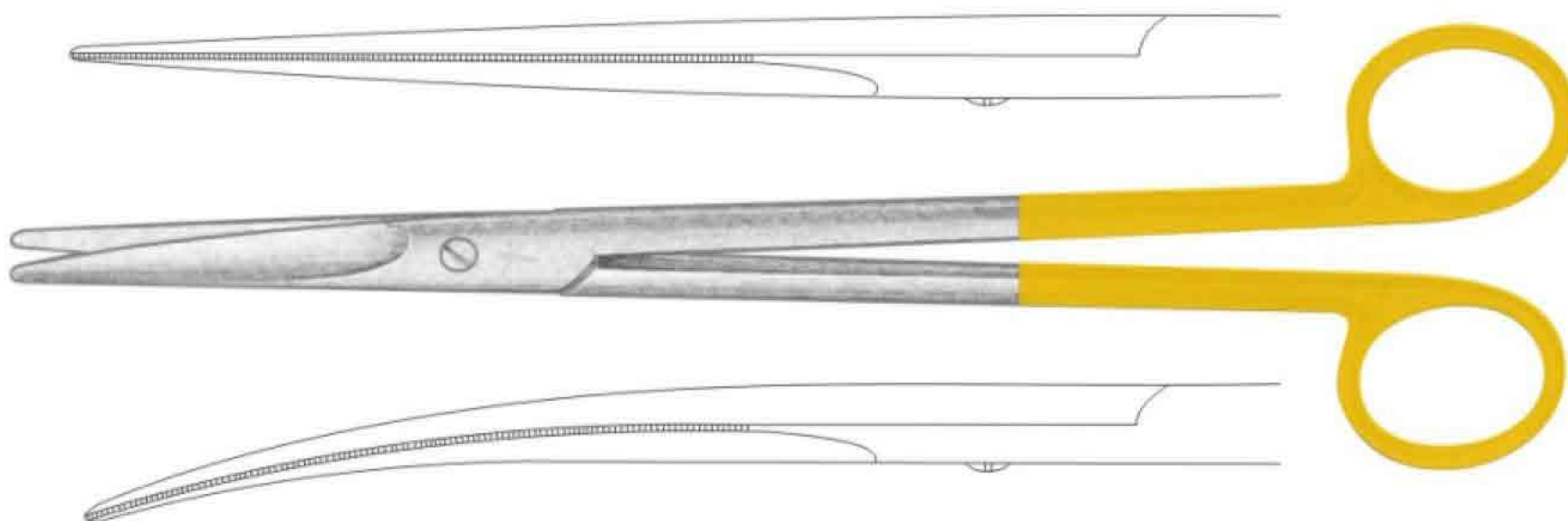
Mayo Scissors

- SSC-11-18-29 14.0 cm / 5½" Straight
- SSC-11-18-30 14.0 cm / 5½" Curved
- SSC-11-18-31 17.0 cm / 6¾" Straight
- SSC-11-18-32 17.0 cm / 6¾" Curved



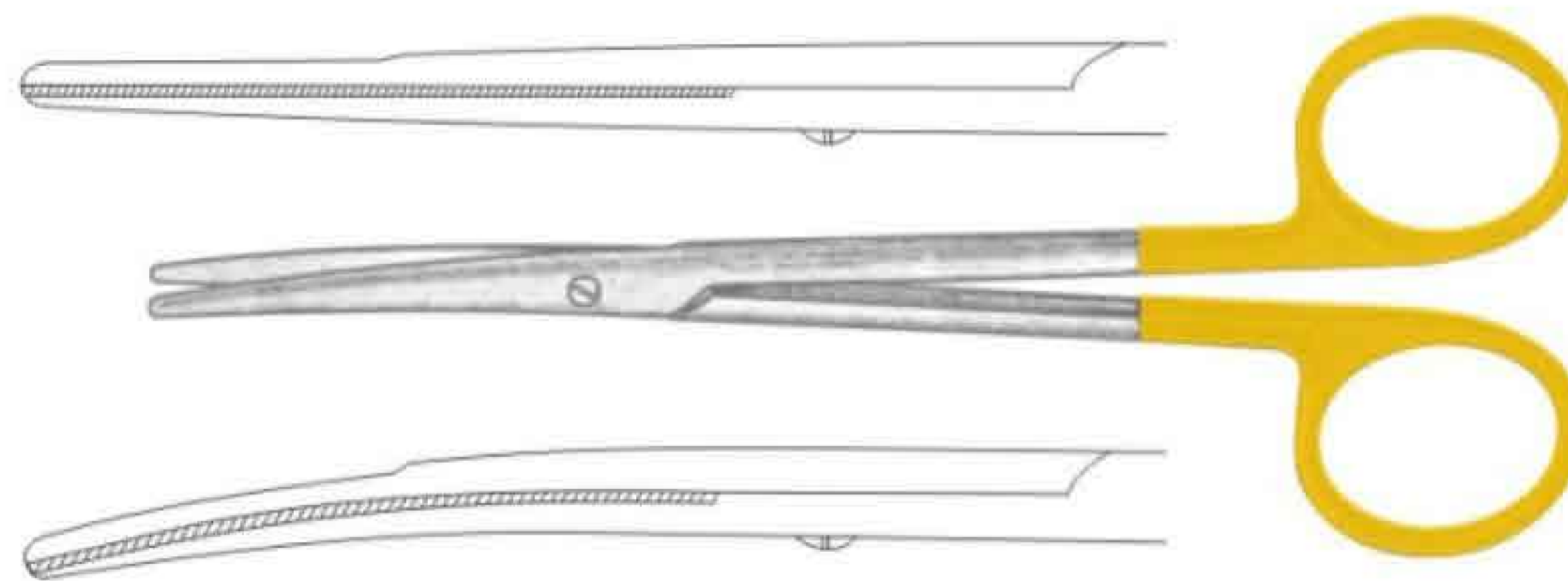
Mayo Scissors

- SSC-11-18-33 23.0 cm / 9" Straight
- SSC-11-18-34 23.0 cm / 9" Curved



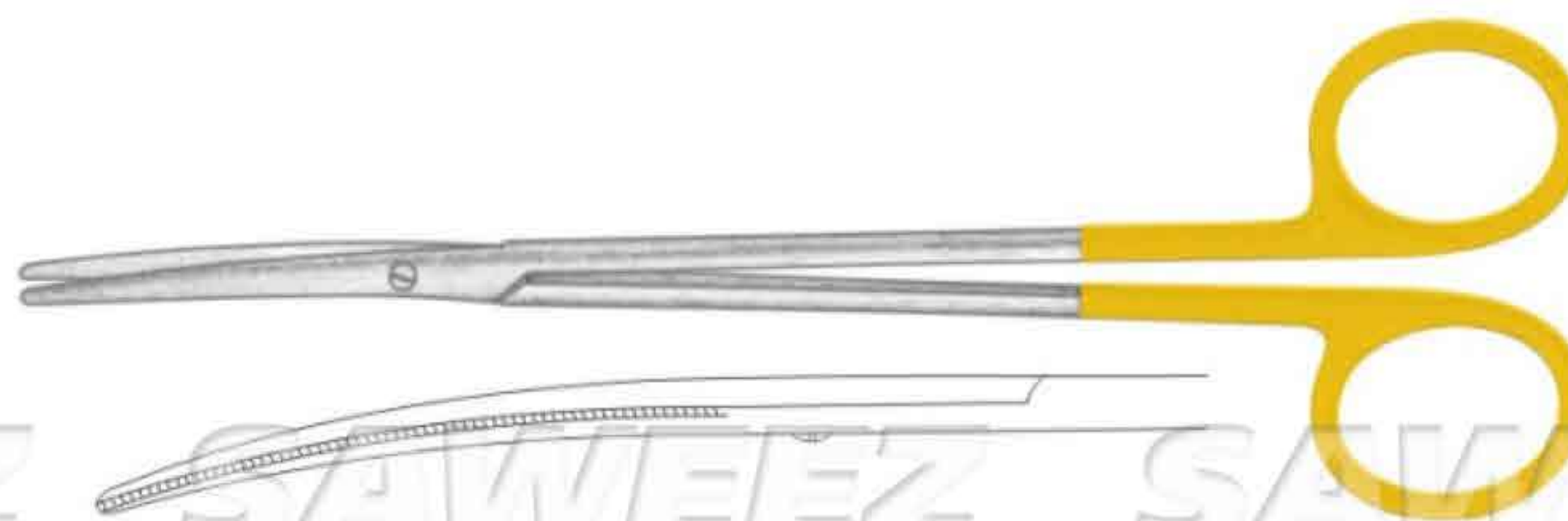
Metzenbaum (Lehey)

- SSC-11-18-35 14.6 cm / 5¾" Straight
- SSC-11-18-36 14.6 cm / 5¾" Curved



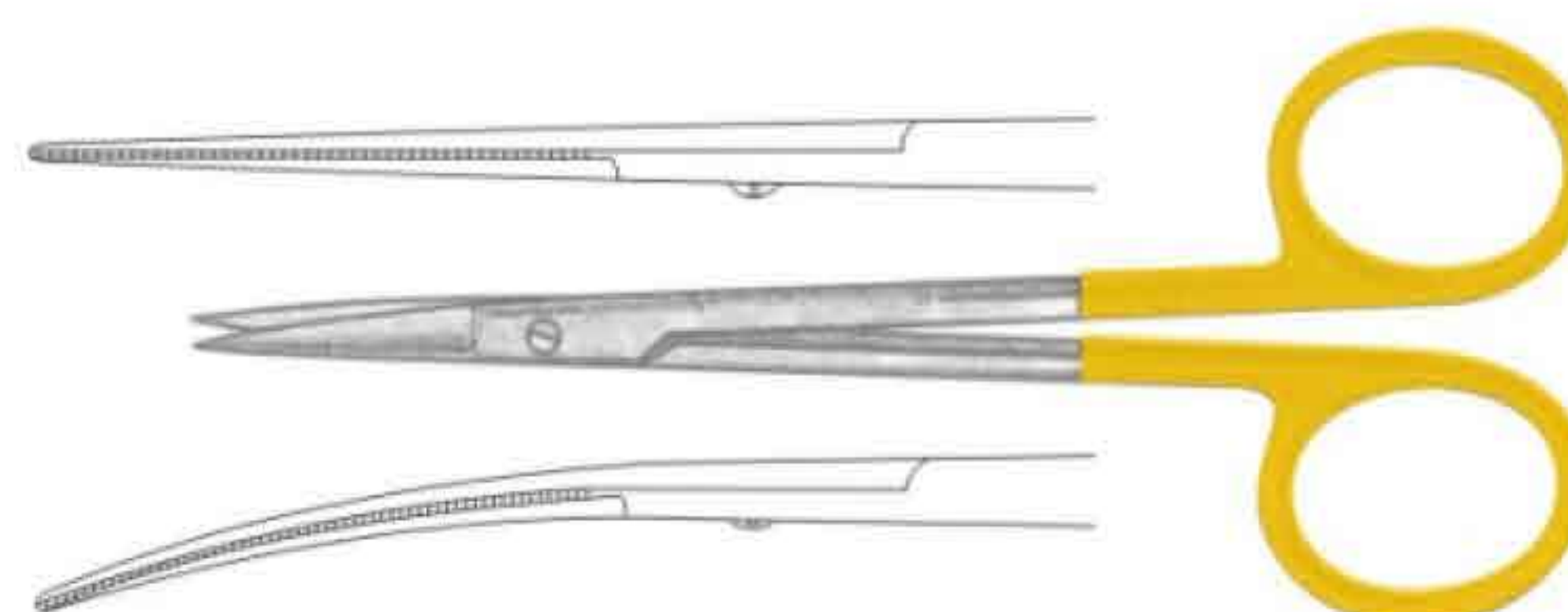
Metzenbaum

- SSC-11-18-37 18.0 cm / 7" Straight
- SSC-11-18-38 23.0 cm / 9" Curved



Iris Scissors

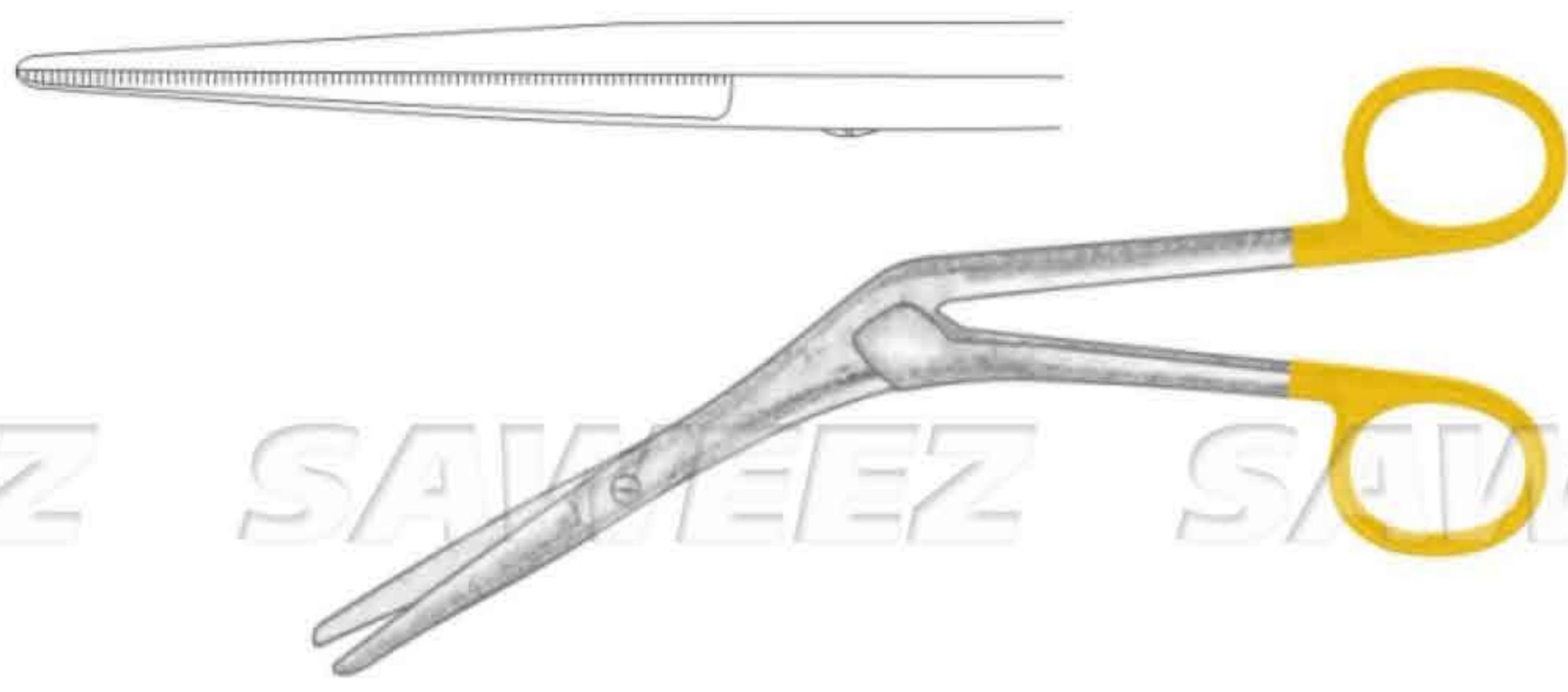
- SSC-11-18-39 11.5 cm / 4½" Straight
- SSC-11-18-40 11.5 cm / 4½" Curved





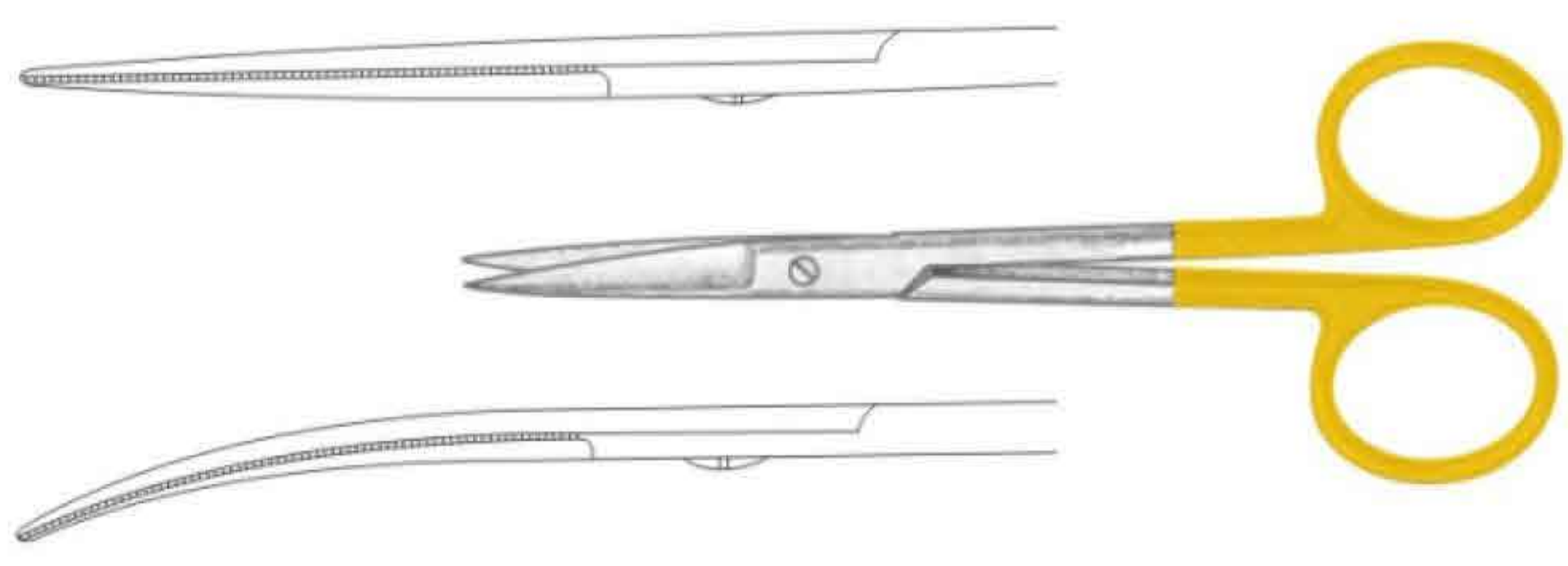
TC GOLD

Knight Nasal Scissors
SSC-11-18-41 17.0 cm / 6¾"



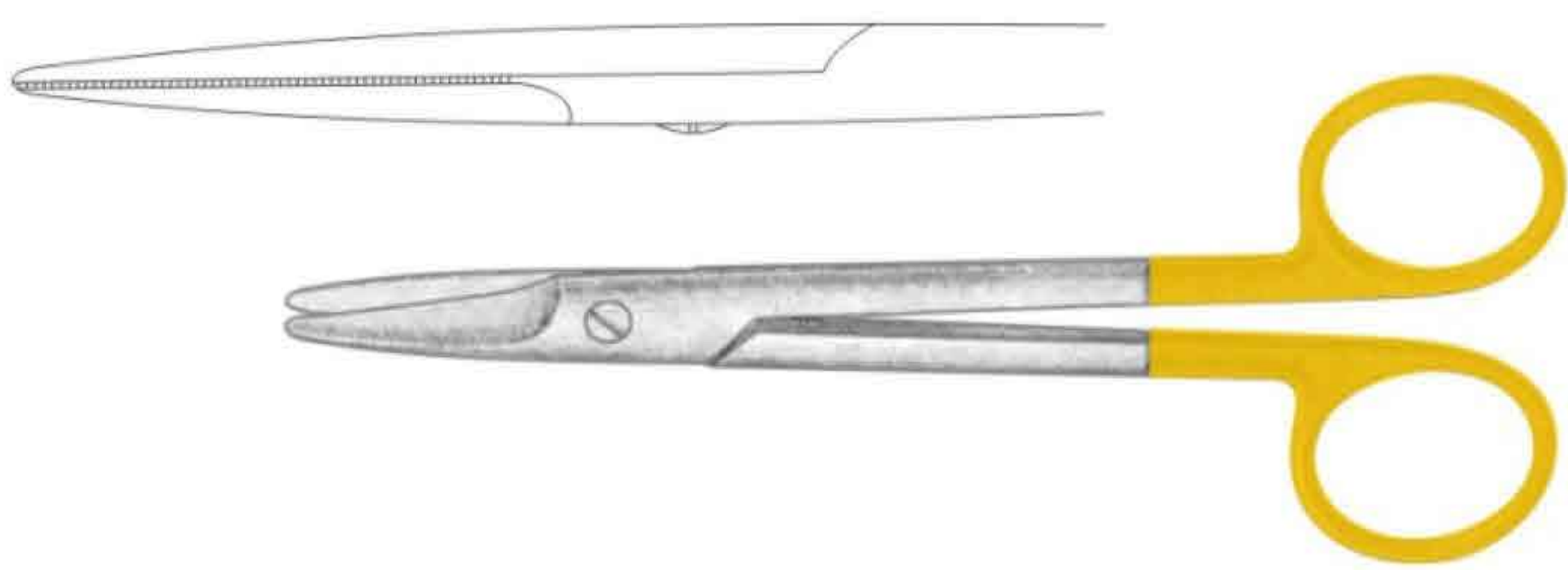
SAWEEZ SAWEEZ SAWEEZ SAWEEZ

Plastic Surgery Scissors
SSC-11-18-42 12.0 cm / 4¾", Straight
SSC-11-18-43 12.0 cm / 4¾", Curved



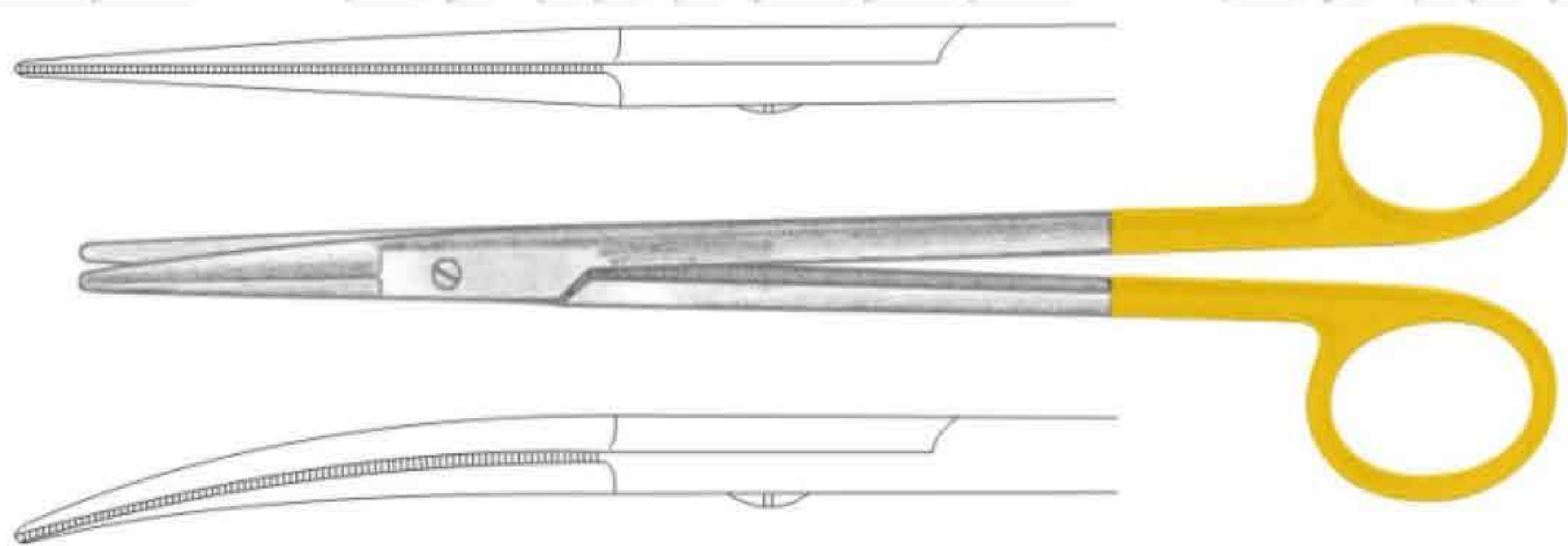
SAWEEZ SAWEEZ SAWEEZ SAWEEZ

Castanares Face Lift Scissors
SSC-11-18-44 - 16.0 cm / 6¼", Straight



SAWEEZ SAWEEZ SAWEEZ SAWEEZ

Gorney
SSC-11-18-45 18.5 cm / 7¼", Straight
SSC-11-18-46 18.5 cm / 7¼", Curved





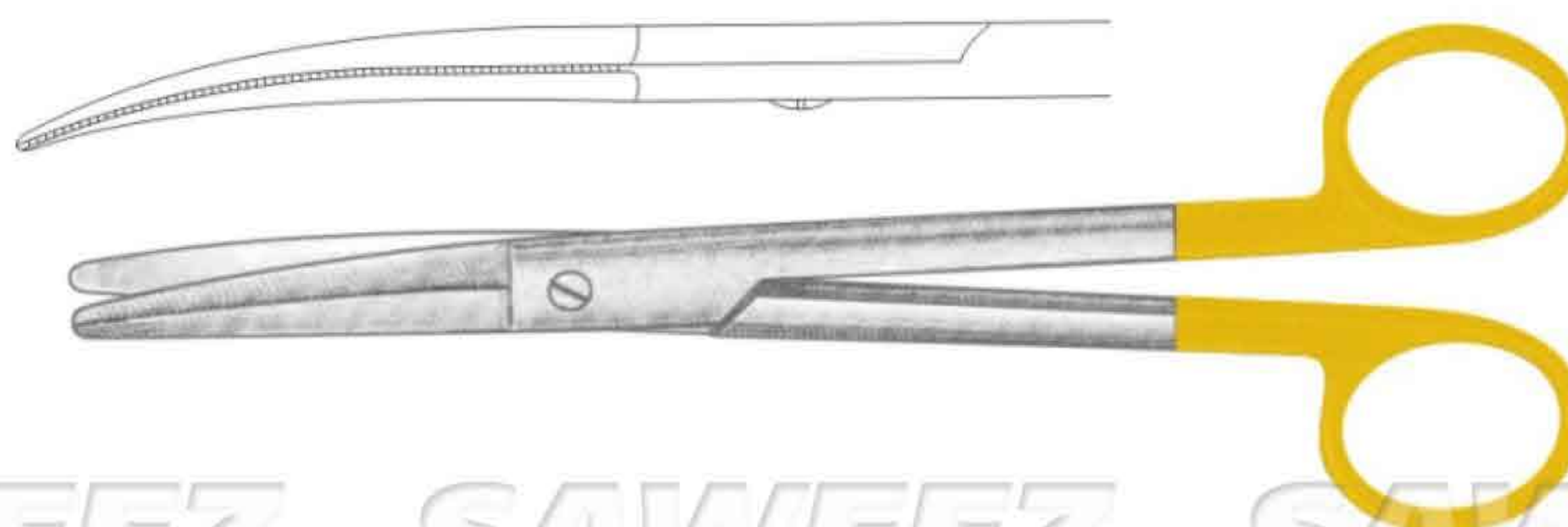
TC / GOLD

Kaye Face Lift Scissors

beveled blades have semi-sharp outer edges

SSC-11-18-47 15.0 cm / 6", Curved

SSC-11-18-48 19.0 cm / 7½", Curved



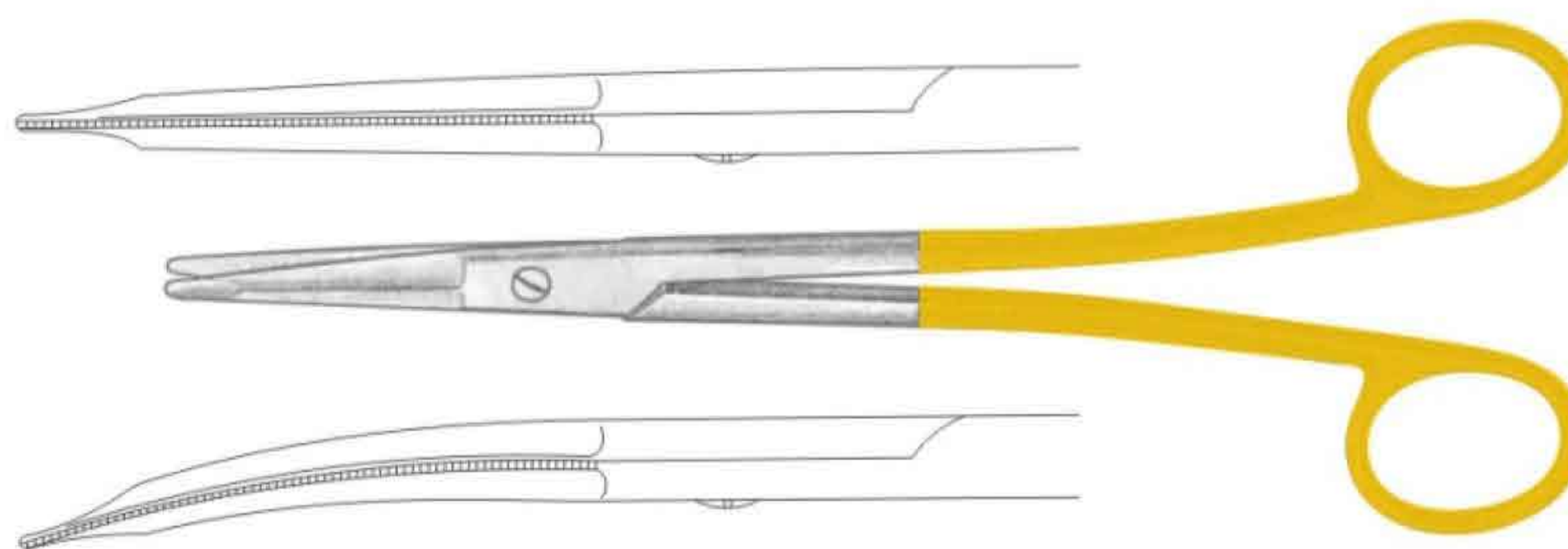
SAWEEZ SAWEEZ SAWEEZ SAWEEZ

Freeman-Gorney Face Lift Scissors

beveled blades have semi-sharp outer edges and flat, tapered tips;

SSC-11-18-49 19.0 cm / 7½", Straight

SSC-11-18-50 19.0 cm / 7½", Curved

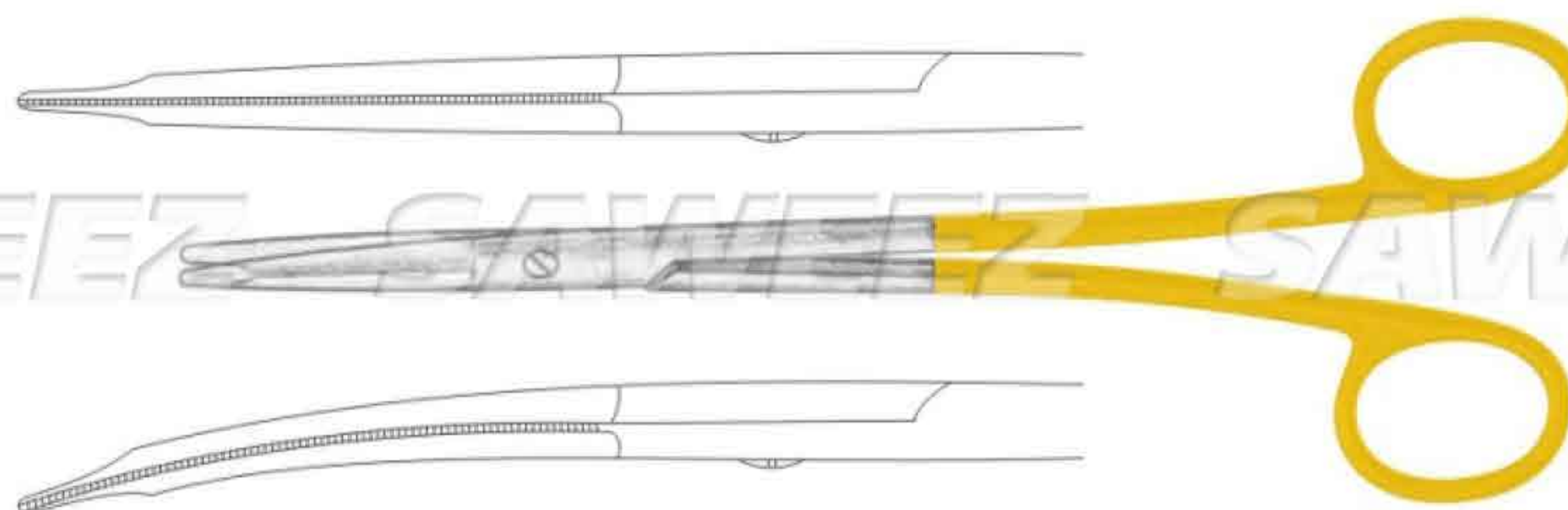


Freeman-Kaye Face Lift Scissors

beveled blades have semi-sharp outer edges and flat, tapered tips;

SSC-11-18-51 - 18.0 cm / 7", Straight

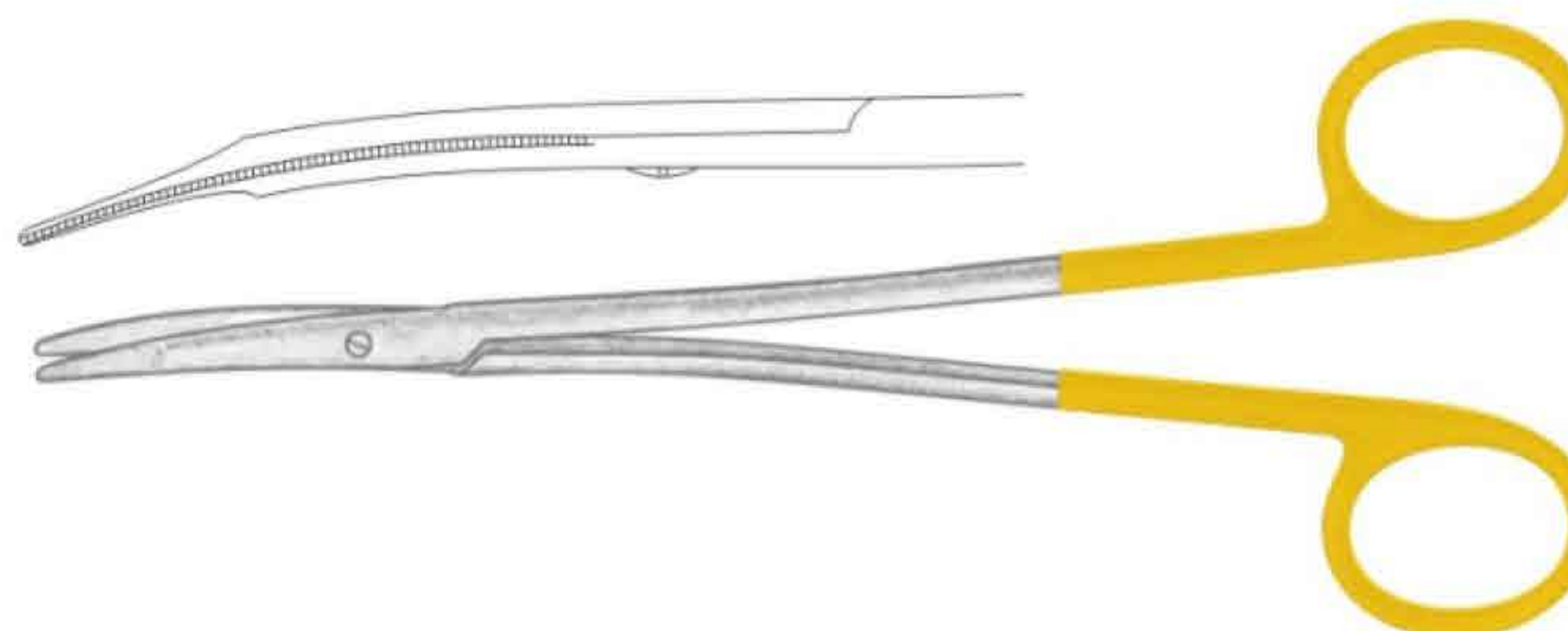
SSC-11-18-52 - 18.0 cm / 7", Curved



SAWEEZ SAWEEZ SAWEEZ SAWEEZ

Freeman Rhytidectomy Scissors

SSC-11-18-53 - 18.0 cm / 7", Curved with flat tips

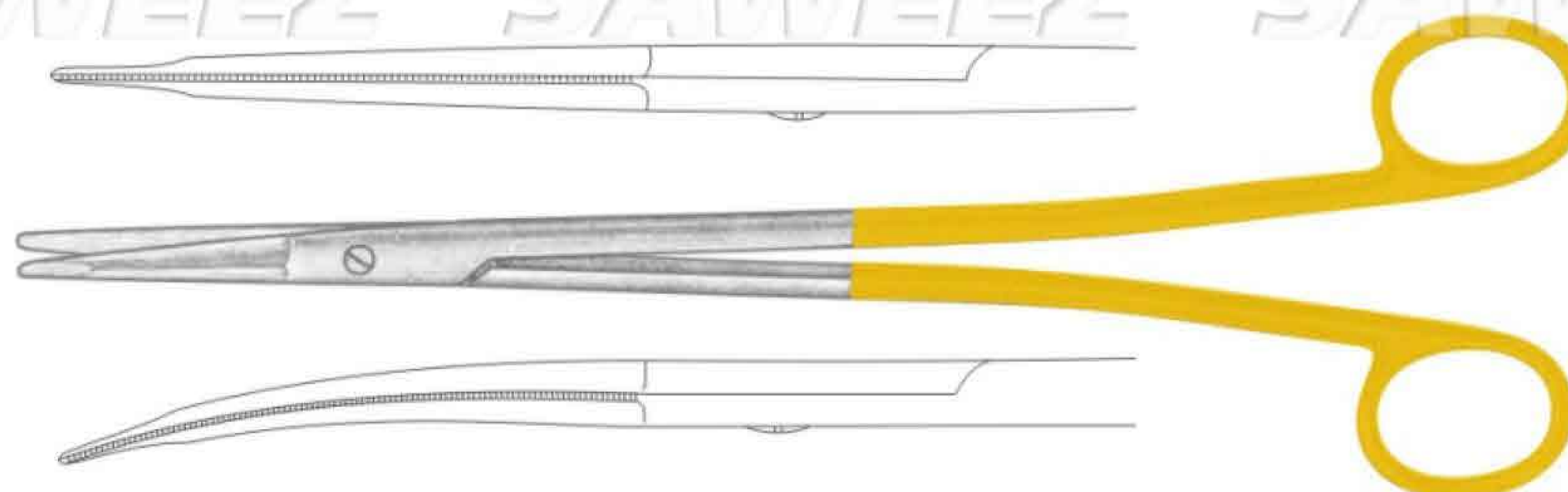


Gorney Platysma Scissors

beveled blades have semi-sharp outer edges and flat, tapered tips;

SSC-11-18-54 - 23.0 cm / 9", Straight

SSC-11-18-55 - 23.0 cm / 9", Curved

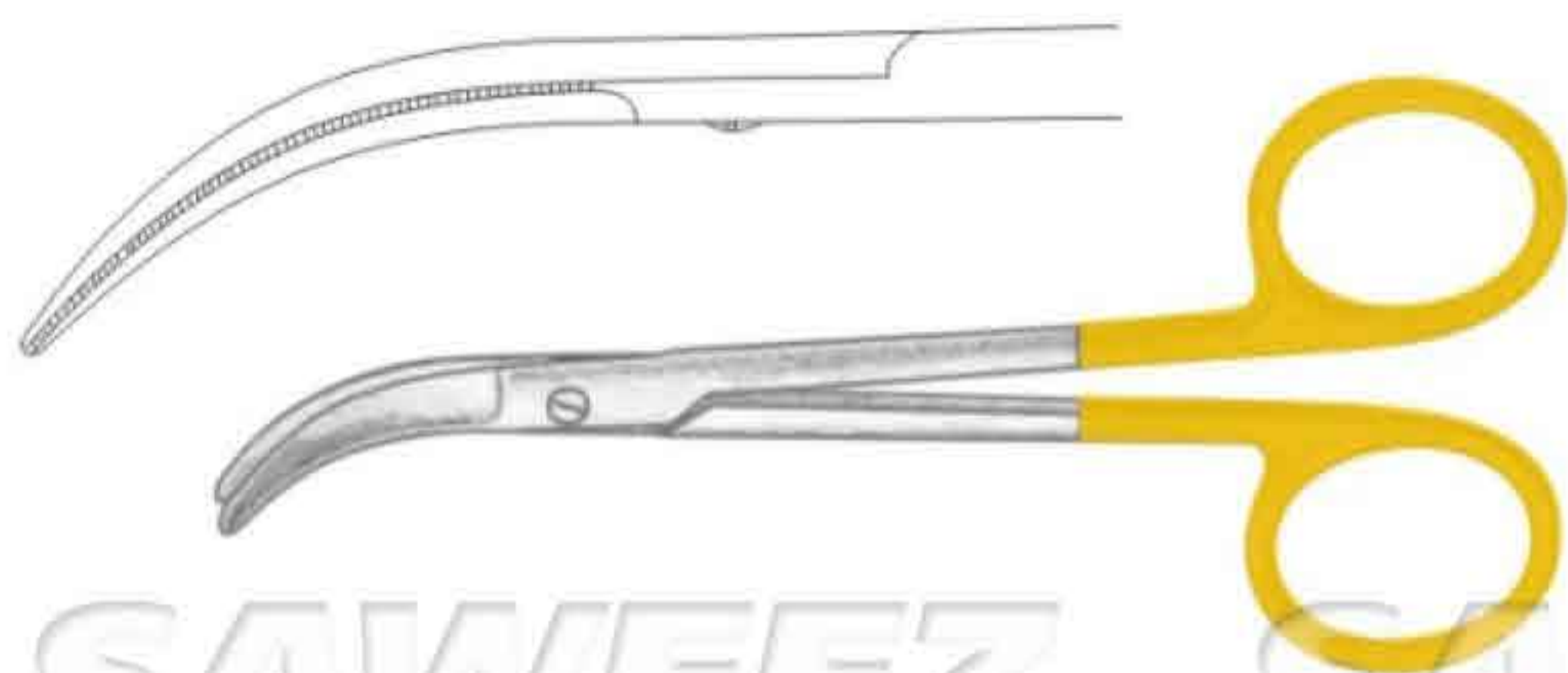


SAWEEZ SAWEEZ SAWEEZ SAWEEZ



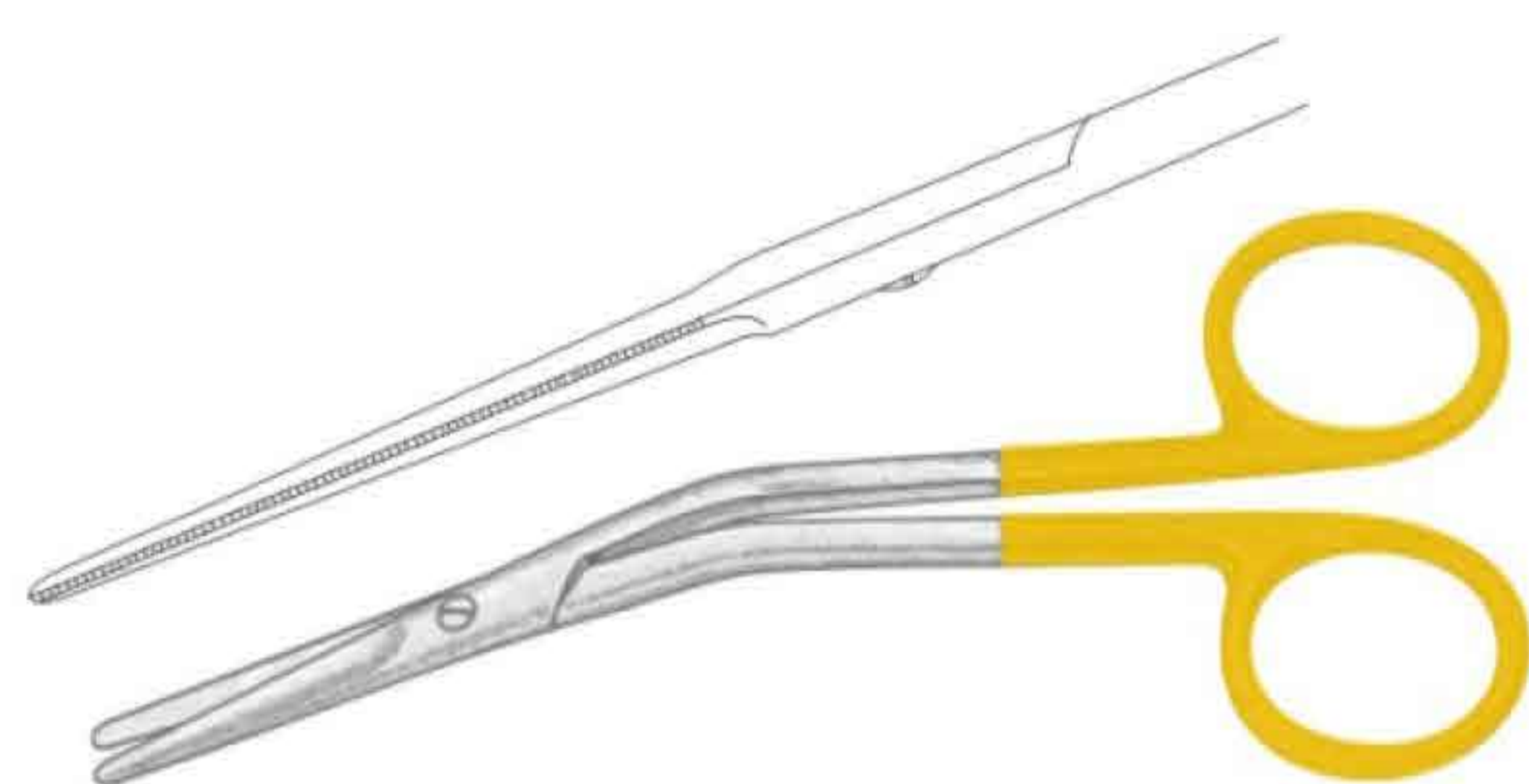
TC / GOLD

Fomon Lateral Scissors
SSC-11-18-56
13.0 cm / 5", full curved



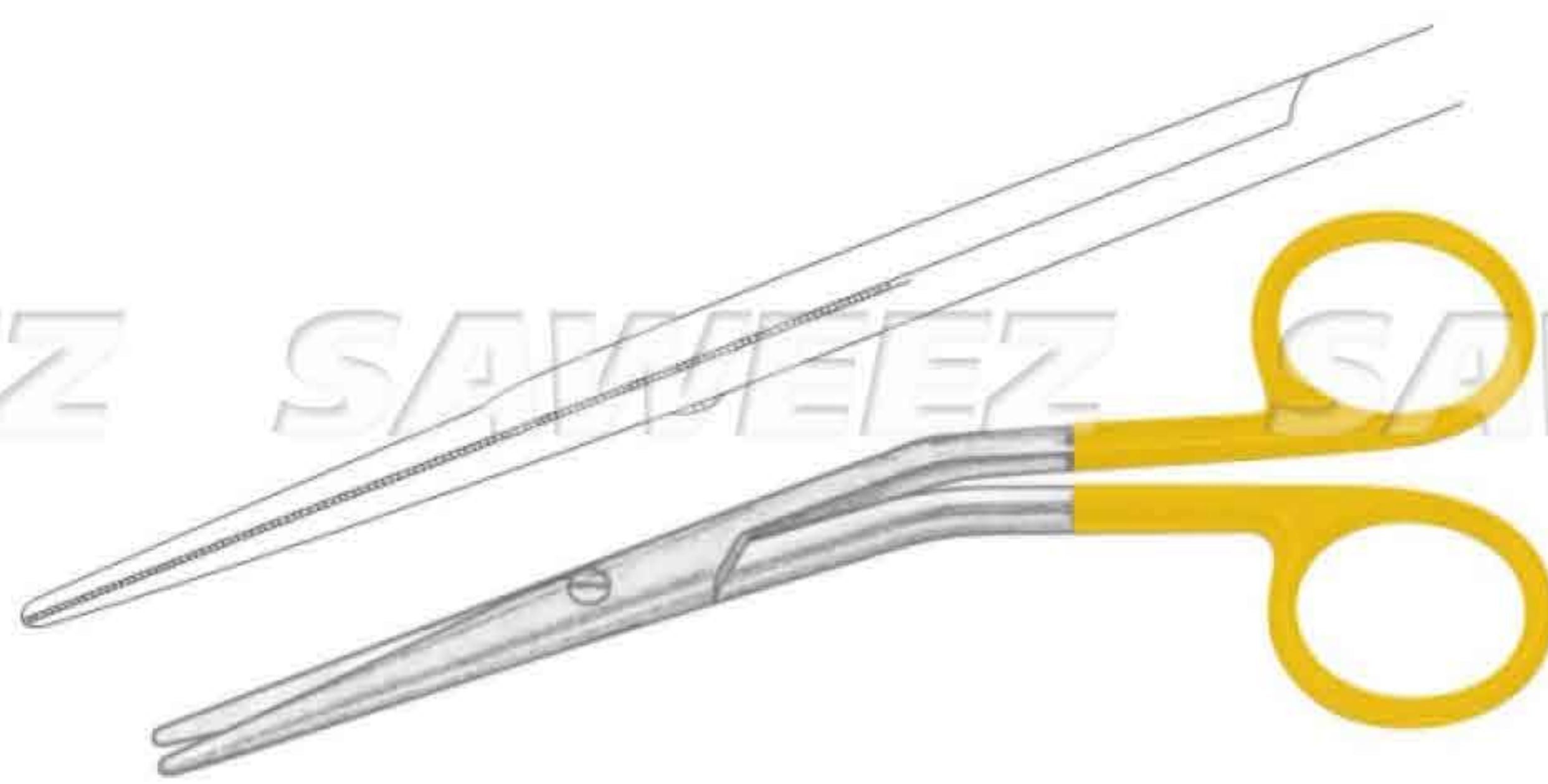
SAWEEZ SAWEEZ SAWEEZ SAWEEZ

Fomon Dorsal Scissors
SSC-11-18-57 - 14.6 cm / 5¾", angled on flat

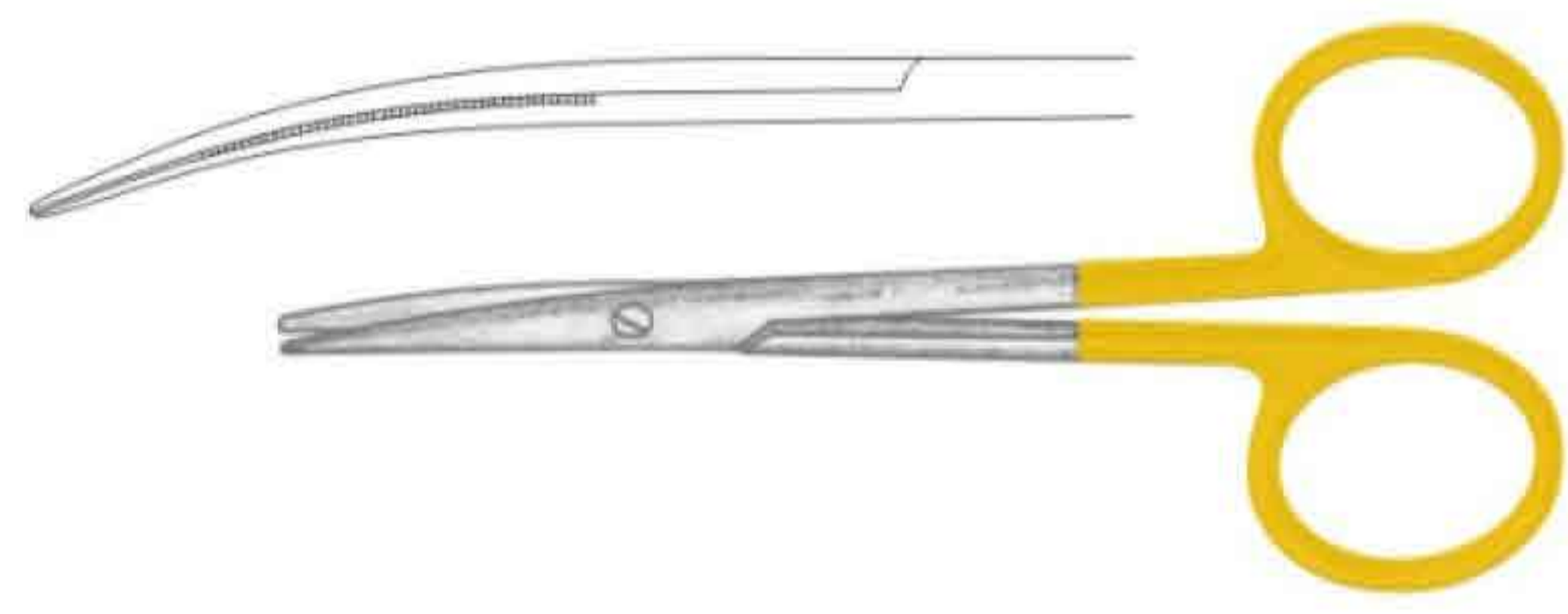


SAWEEZ SAWEEZ SAWEEZ SAWEEZ

Cottle Dorsal Scissors
SSC-11-18-58 16.5 cm / 6½", angled on flat

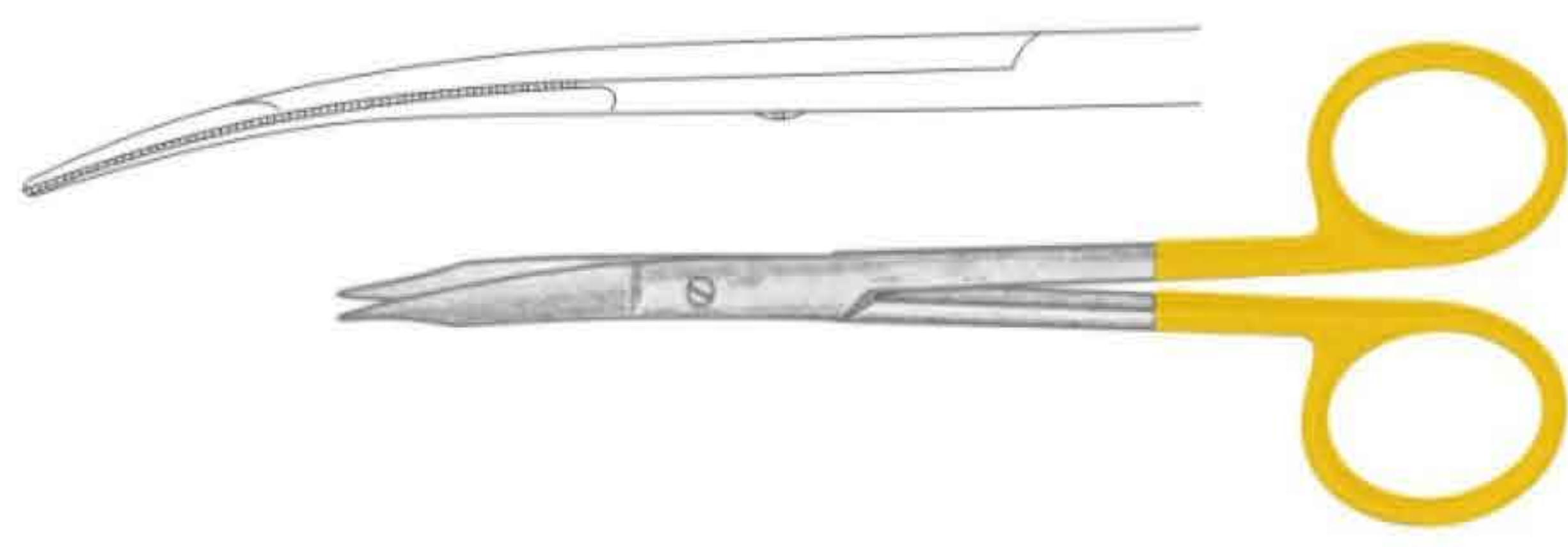


Plastic and Reconstructive Scissors
SSC-11-18-59 11.4 cm / 4½", curved
SSC-11-18-60 14.6 cm / 5¾", curved



SAWEEZ SAWEEZ SAWEEZ SAWEEZ

Petit-Point Reconstructive Scissors
SSC-11-18-61 13.0 cm / 5", curved





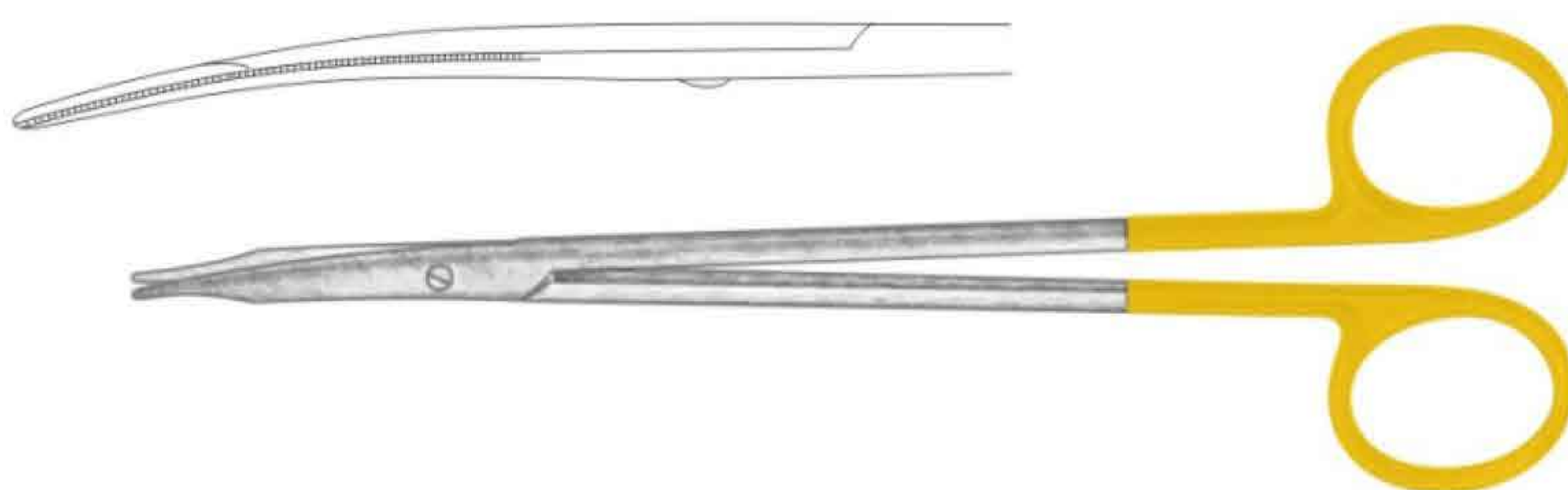
TC / GOLD

SAWEEZ SAWEEZ SAWEEZ SAWEEZ

Jamison Scissors

SSC-11-18-62 14.0 cm / 5½", curved

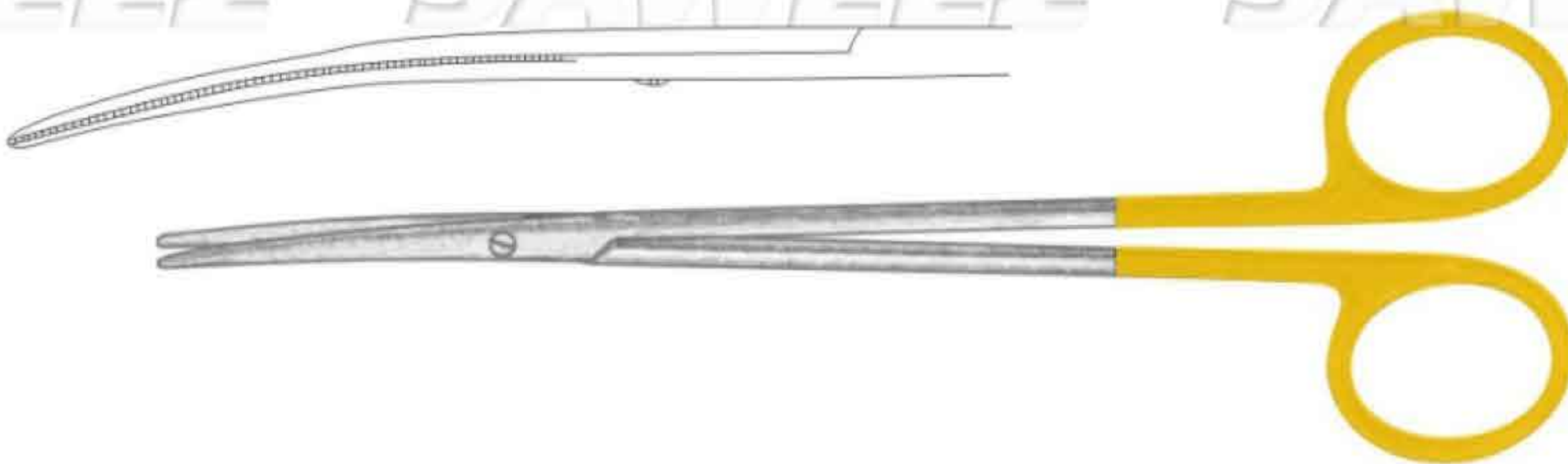
SSC-11-18-63 18.0 cm / 7", curved



SAWEEZ SAWEEZ SAWEEZ SAWEEZ

Metzenbaum Scissors

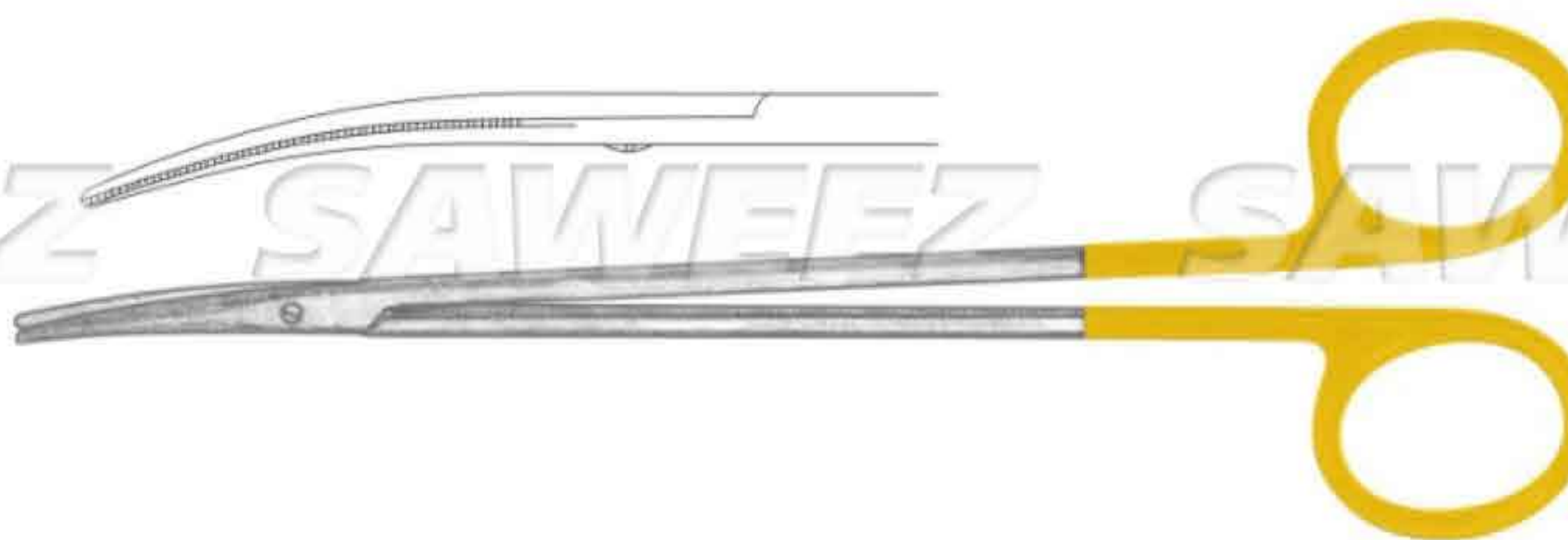
SSC-11-18-64 18.0 cm / 7" curved, delicate



SAWEEZ SAWEEZ SAWEEZ SAWEEZ

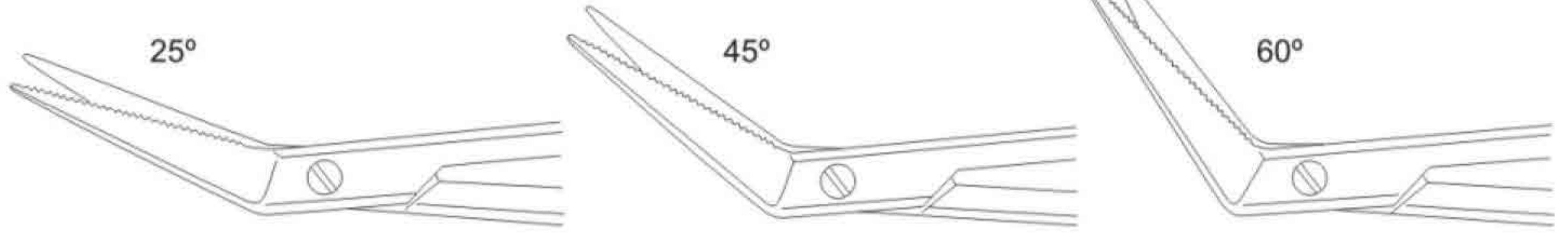
Endarterectomy Scissors

SSC-11-18-65 17.0 cm / 6¾" curved, delicate

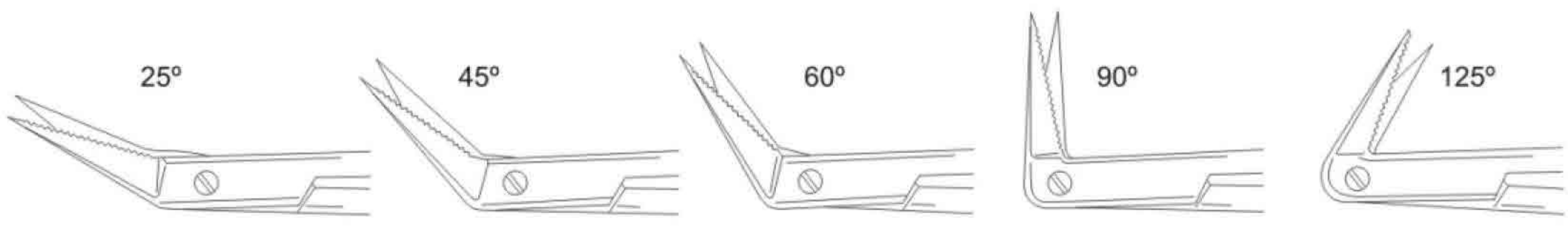




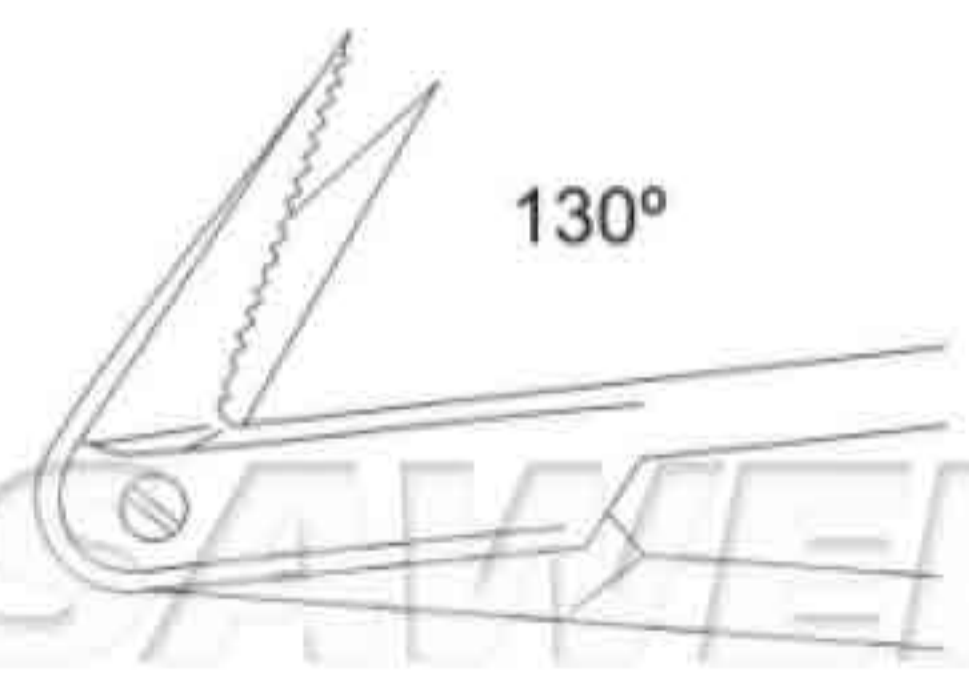
TC GOLD



Potts-Smith Scissors
 SSC-11-18-66 18.0 cm / 7" 25°
 SSC-11-18-67 18.0 cm / 7" 45°
 SSC-11-18-68 18.0 cm / 7" 60°

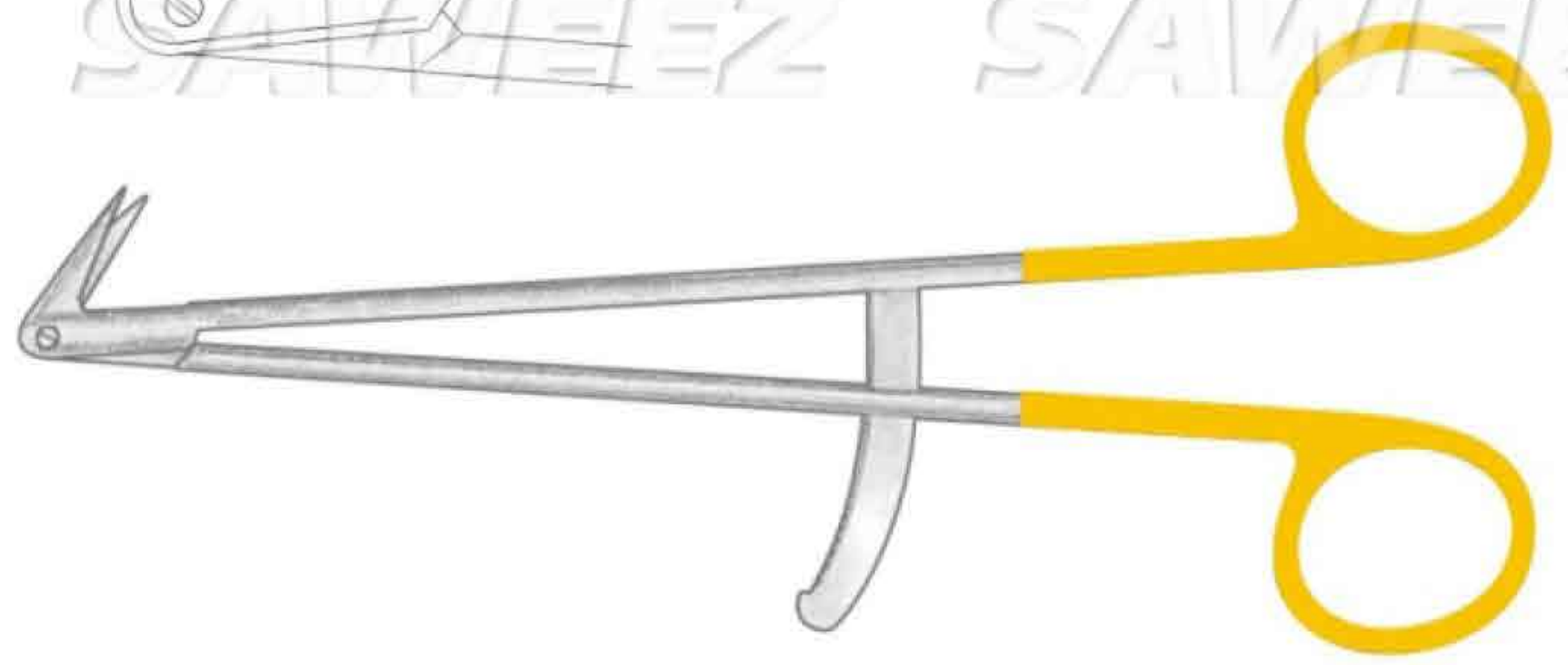


Diethrich Coronary Artery Scissors
 SSC-11-18-69 18.0 cm / 7" 25°
 SSC-11-18-70 18.0 cm / 7" 45°
 SSC-11-18-71 18.0 cm / 7" 60°
 SSC-11-18-72 18.0 cm / 7" 90°
 SSC-11-18-73 18.0 cm / 7" 125°



Diethrich Coronary Artery Scissors
 SSC-11-18-74 - 18.0 cm / 7" 130°

shanks are stabilized to keep blades in alignment





TC / GOLD



Ferris-Smith

SSC-11-18-75
17.0 cm / 6¾"
Normal profile



Bonney
Normal profile

SSC-11-18-76 SSC-11-18-77
17.0 cm / 6¾" 17.0 cm / 6¾"



Gerald

SSC-11-18-78 SSC-11-18-79
17.0 cm / 6¾" 17.0 cm / 6¾"
Micro profile Micro profile



Gillies

SSC-11-18-80
15.0 cm / 6"
Mini profile



Mc Indoe

SSC-11-18-81
15.0 cm / 6"
Mini profile

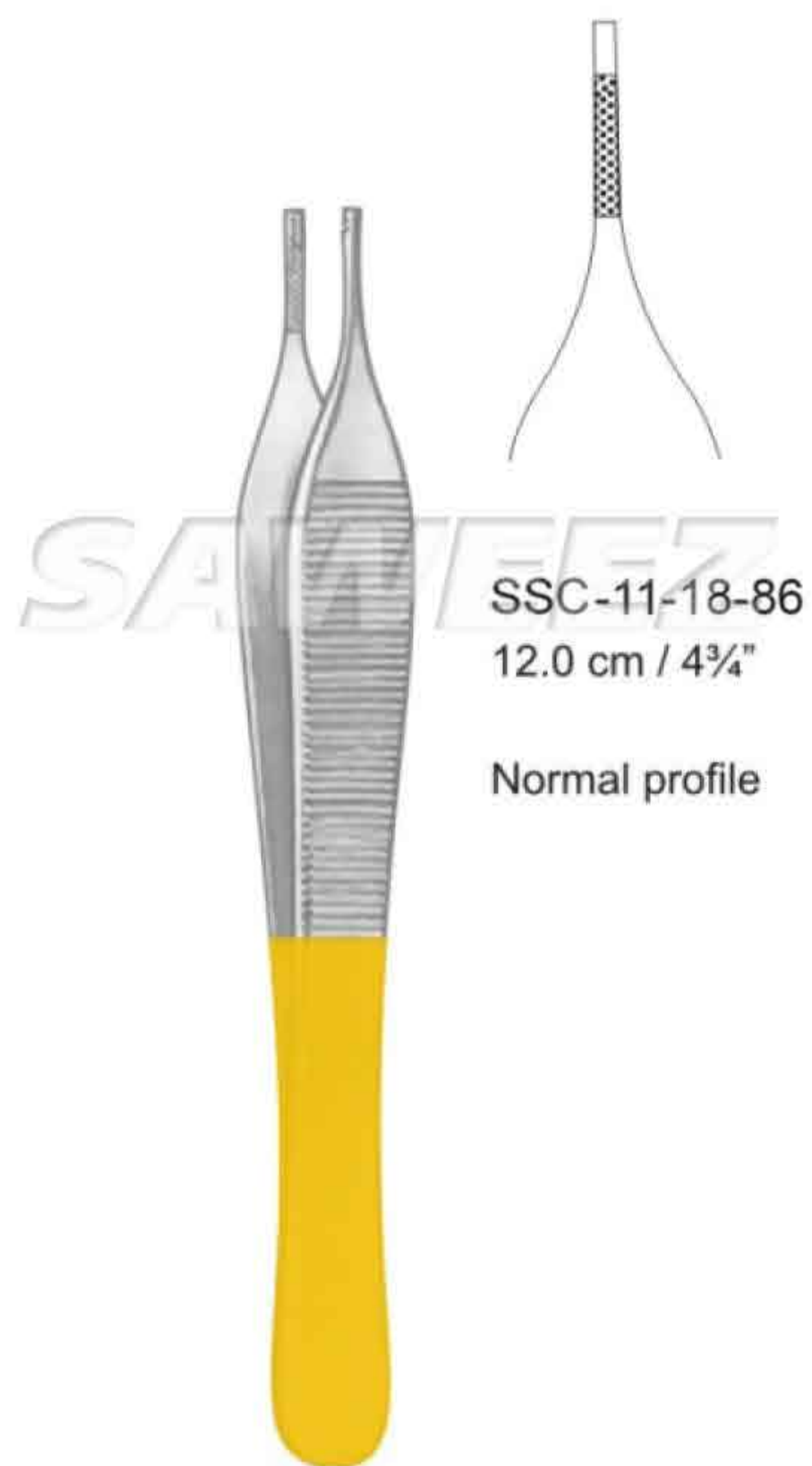


Semken

SSC-11-18-82 SSC-11-18-83 SSC-11-18-84 SSC-11-18-85
16.0 cm / 6¼" 18.0 cm / 7" 16.0 cm / 6¼" 18.0 cm / 7"
Normal profile Mini profile



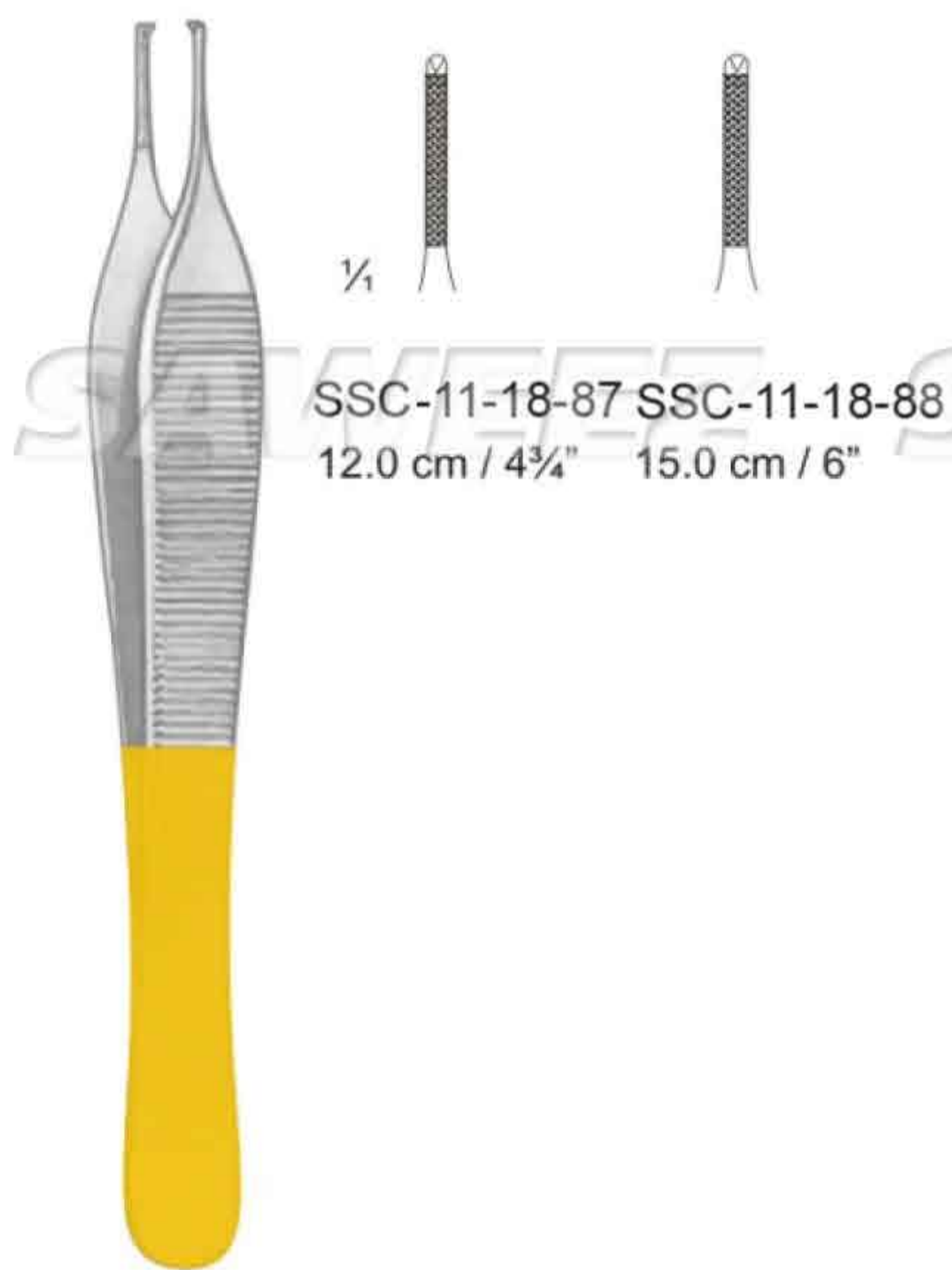
TC GOLD



SSC-11-18-86
12.0 cm / 4 3/4"

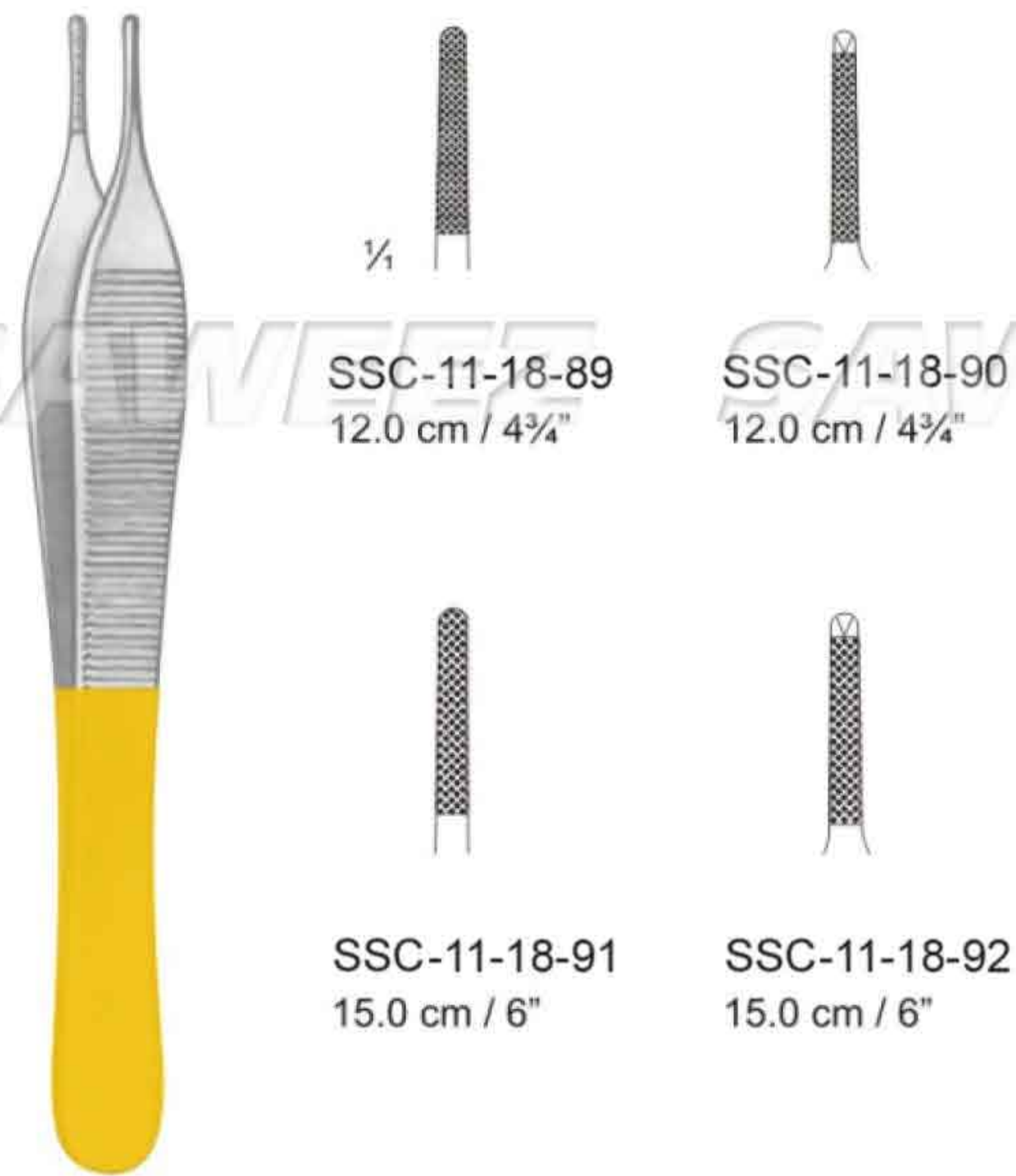
Normal profile

Adson-Brown



SSC-11-18-87 SSC-11-18-88
12.0 cm / 4 3/4" 15.0 cm / 6"

Micro-Adson
Mini profile



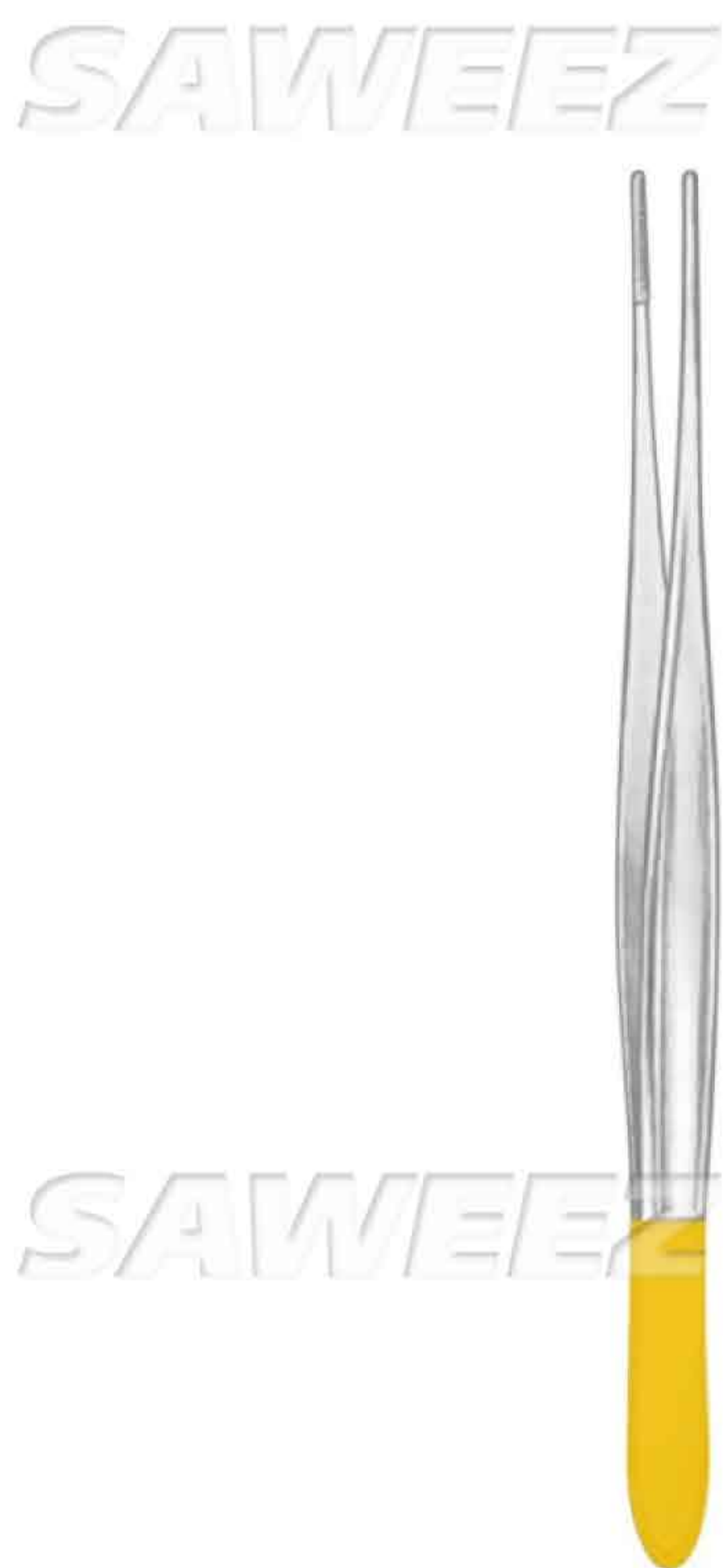
SSC-11-18-89
12.0 cm / 4 3/4"

SSC-11-18-90
12.0 cm / 4 3/4"

SSC-11-18-91
15.0 cm / 6"

SSC-11-18-92
15.0 cm / 6"

Adson
Normal profile



SSC-11-18-93
17.0 cm / 7"

with dissector end

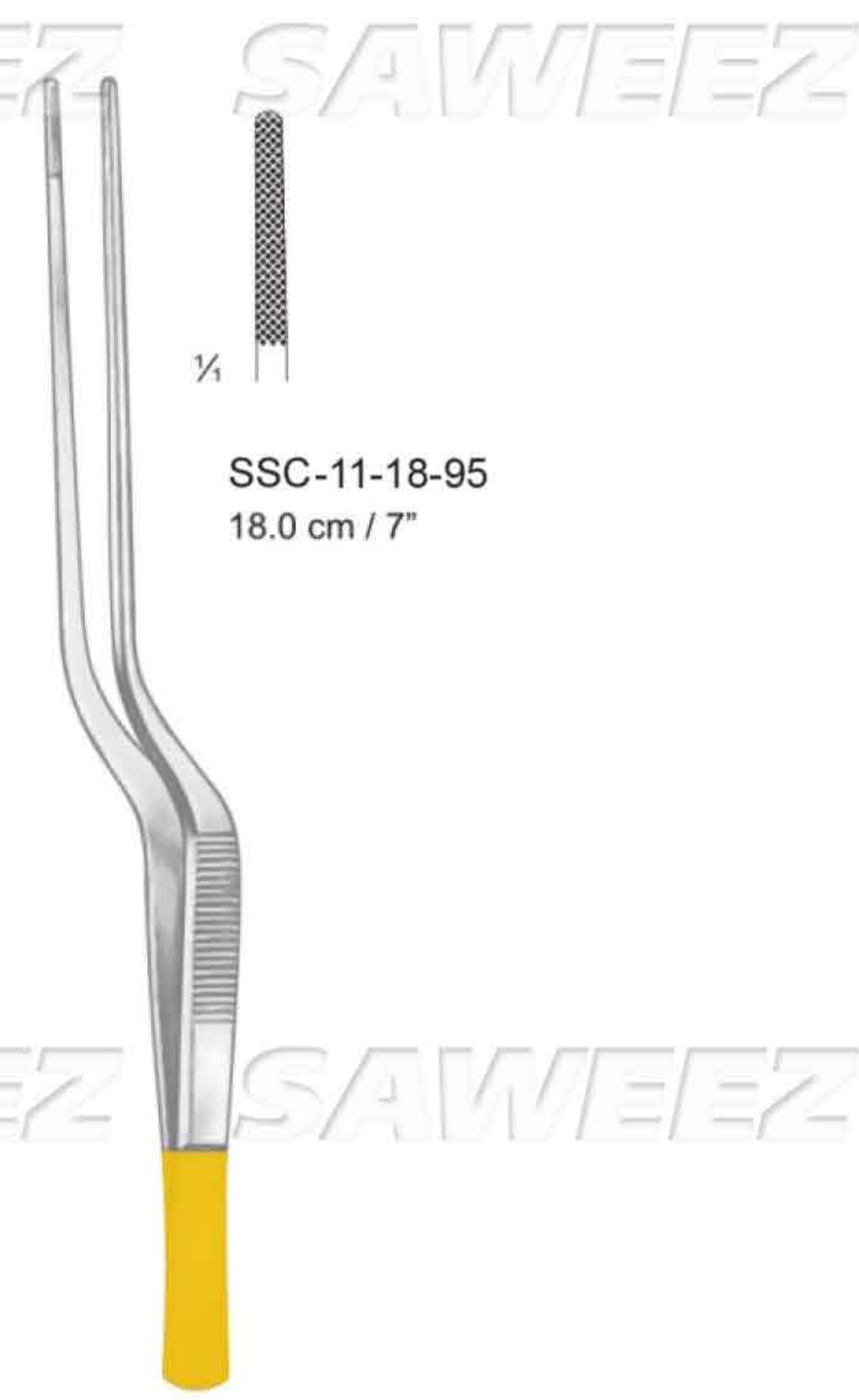
Cushing
Normal profile



SSC-11-18-94
18.0 cm / 7"

with dissector end

Cushing
Normal profile



SSC-11-18-95
18.0 cm / 7"






Cushing-Taylor
Normal profile



TC / GOLD



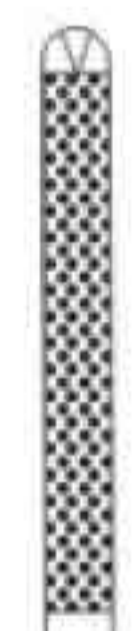





Potts-Smith

				
SSC-11-18-96 15.0 cm / 6"	SSC-11-18-97 18.0 cm / 7"	SSC-11-18-98 20.0 cm / 8"	SSC-11-18-99 23.0 cm / 9"	SSC-11-19-00 25.0 cm / 10"

Normal profile



Oehler

					
SSC-11-19-01 14.0 cm / 5½"	SSC-11-19-02 16.0 cm / 6½"	SSC-11-19-03 18.0 cm / 7"	SSC-11-19-04 20.0 cm / 8"	SSC-11-19-05 25.0 cm / 10"	SSC-11-19-06 30.0 cm / 12"

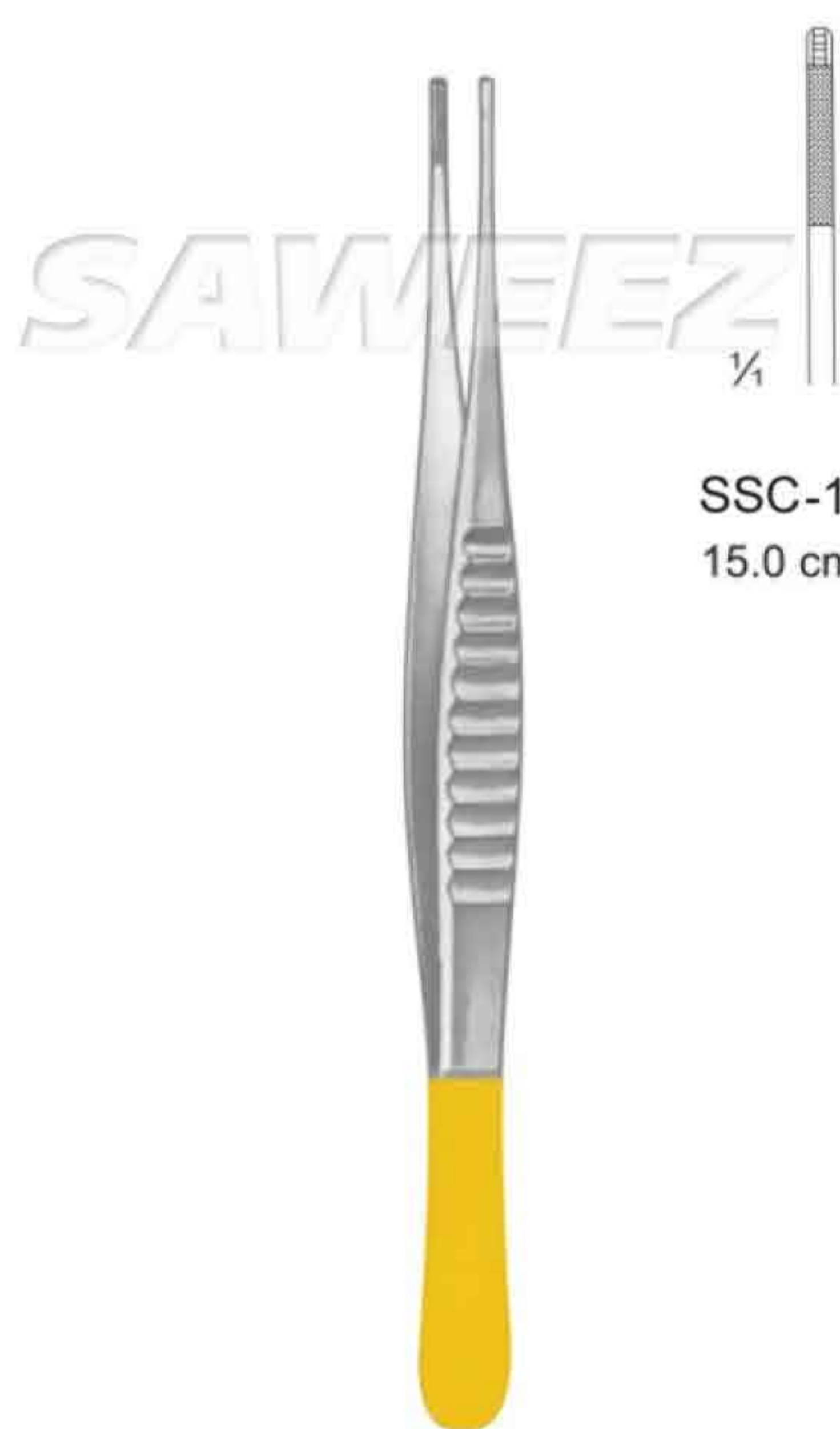
Normal profile



TC / GOLD

Micro profile

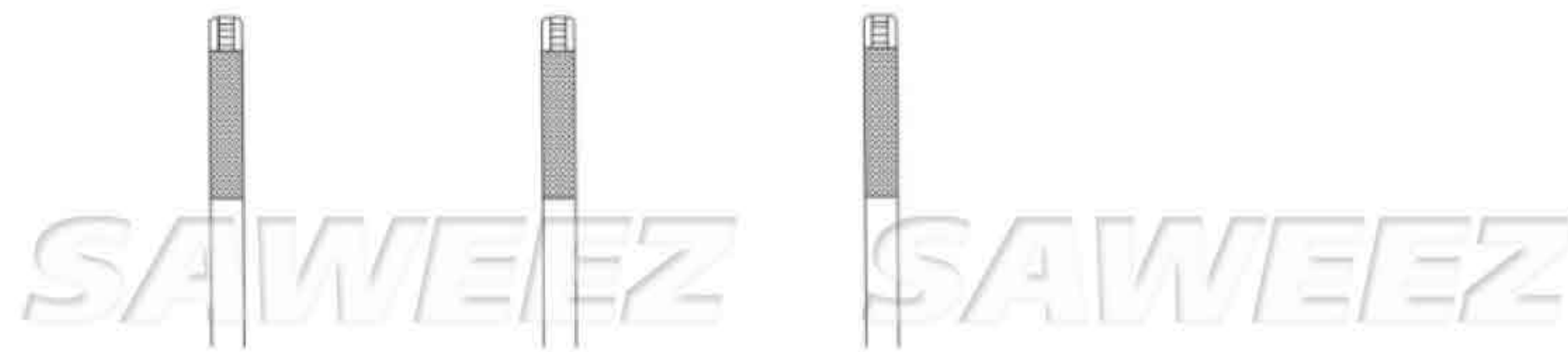
Mini profile



De Bakey



SSC-11-19-07 15.0 cm / 6"
SSC-11-19-08 19.0 cm / 7½"
SSC-11-19-09 24.0 cm / 9½"



SSC-11-19-10 15.0 cm / 6"
SSC-11-19-11 19.0 cm / 7½"
SSC-11-19-12 24.0 cm / 9½"



SSC-11-19-14 15.0 cm / 6"
SSC-11-19-15 23.0 cm / 9"
SSC-11-19-16 25.0 cm / 10"



SSC-11-19-13
15.0 cm / 6"

Smooth



Wangenstein
Normal Profile



1/2
Graefe
16.0 cm / 6 1/4"



1/4
SSC-11-19-17
sharp



SSC-11-19-18
blunt



1/2
Graefe
16.0 cm / 6 1/4"



1/4
SSC-11-19-19



SSC-11-19-20



SSC-11-19-21



SSC-11-19-22



1/2
O'Connor



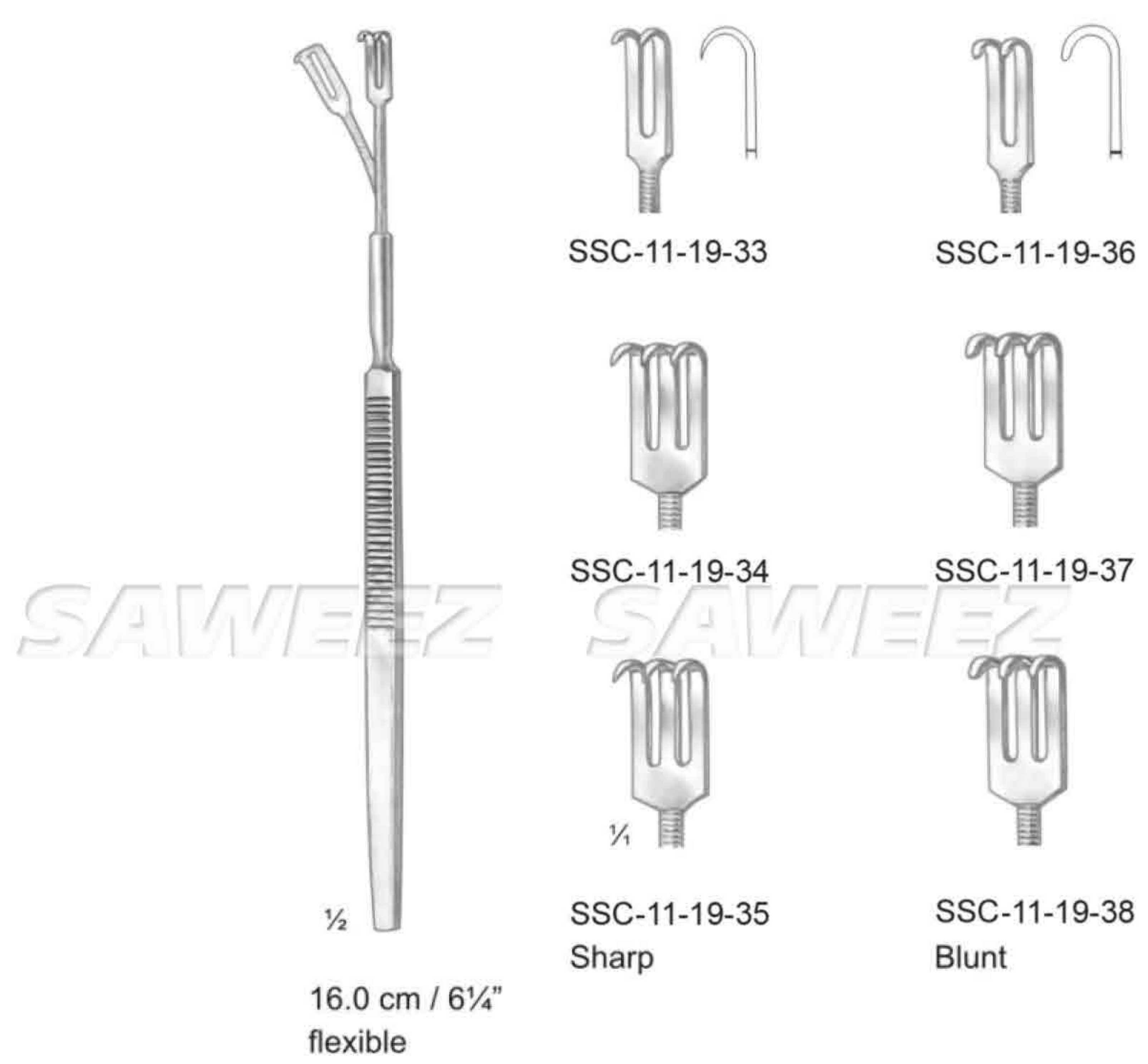
1/4
SSC-11-19-23
16.0 cm / 6 1/4"

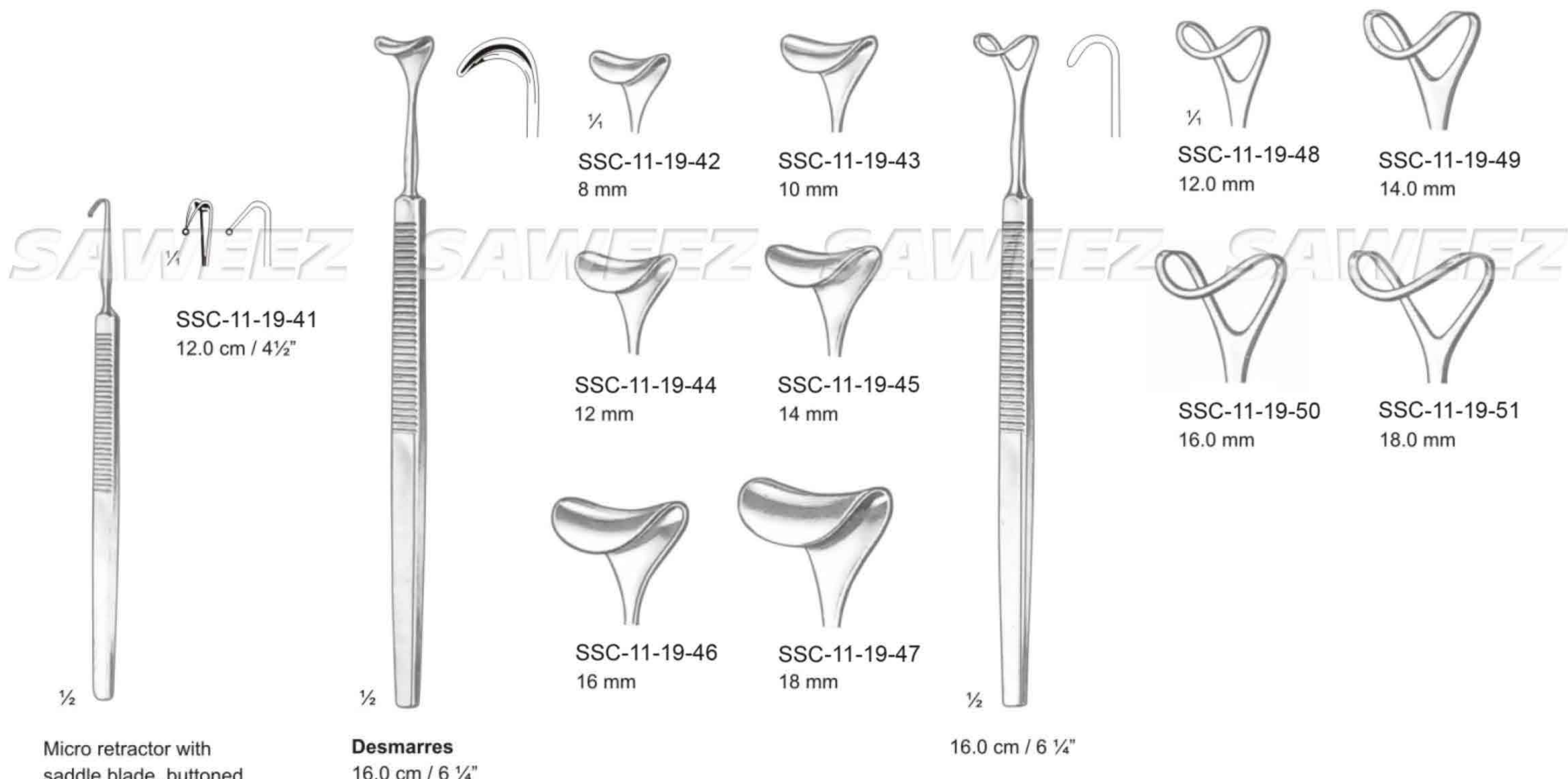


Guthrie



1/4
SSC-11-19-24
16.0 cm / 6 1/4"





SAWEEZ SAWEEZ SAWEEZ SAWEEZ





16.0 cm / 6 1/4"



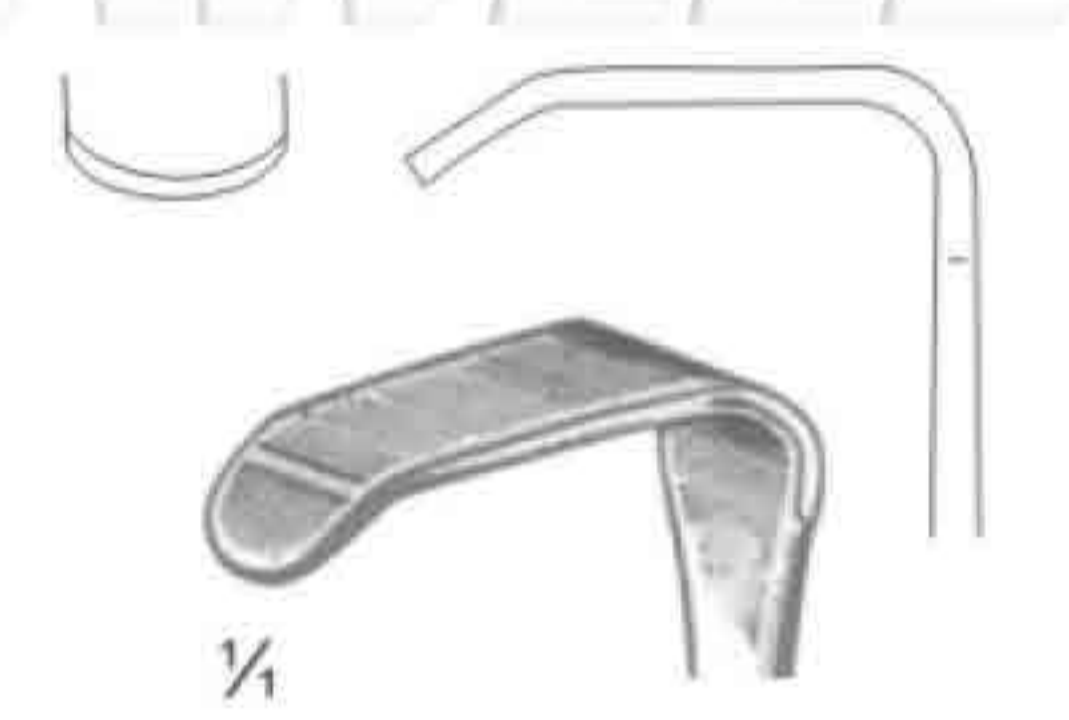
16.0 cm / 6 1/4"



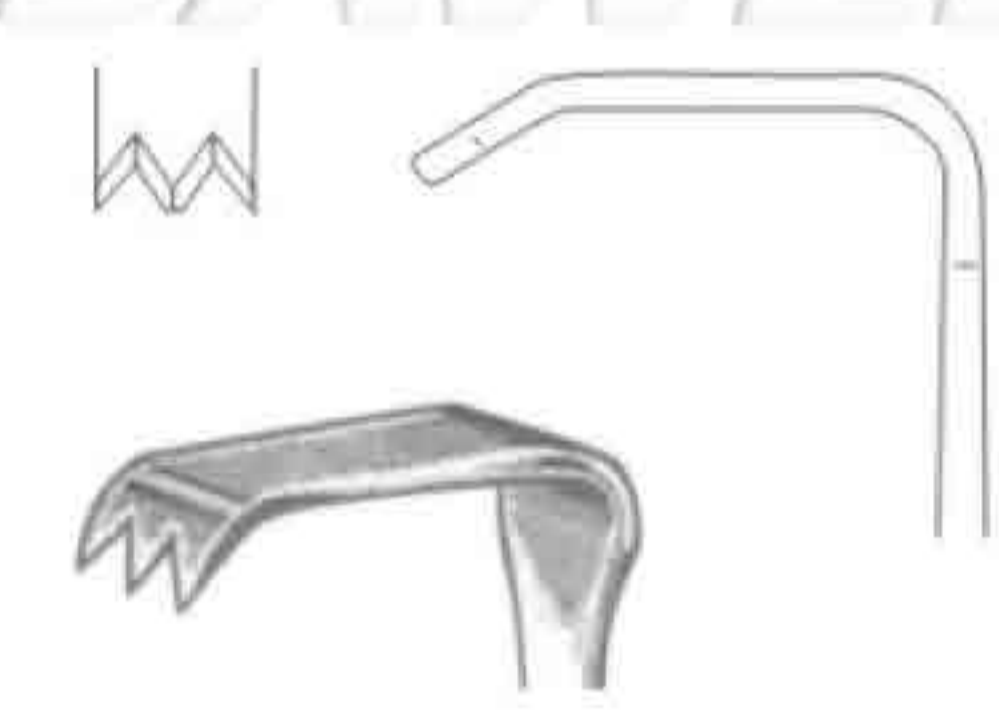
16.0 cm / 6 1/4"



18.0 cm / 7"



18 x 7 mm



16 x 5 mm



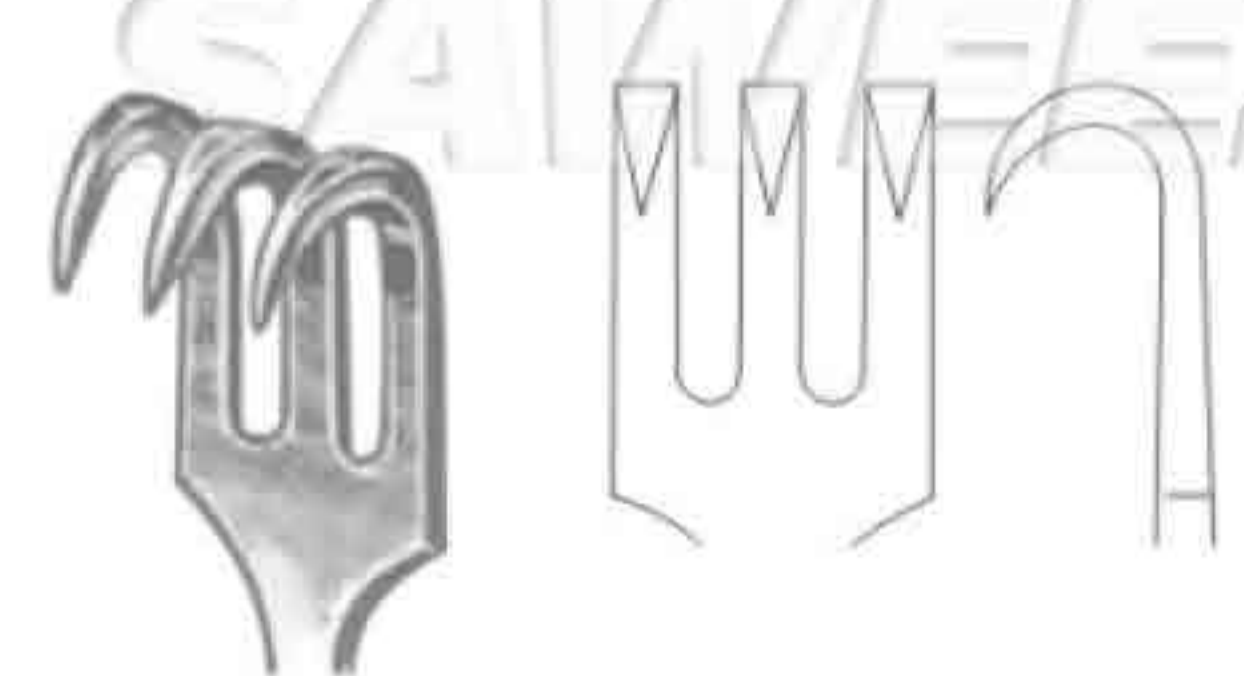
7 x 4 mm



10 x 3 mm



7 x 4 mm



10 x 4 mm



Senn-Green
15.0 cm / 6"



SSC-11-19-75
20 x 6 mm



SSC-11-19-76
10 x 6 mm



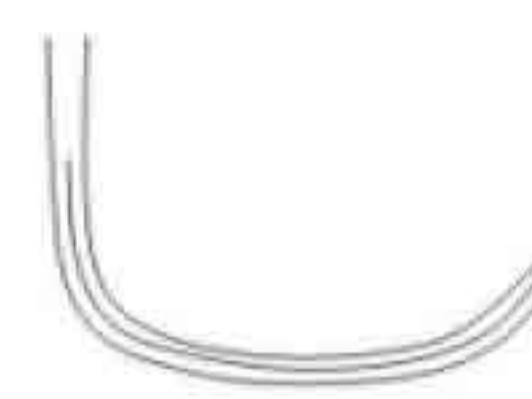
Ragnell-Davis



8 x 4 mm

SSC-11-19-77
14.0 cm / 5½"

15 x 5.5 mm

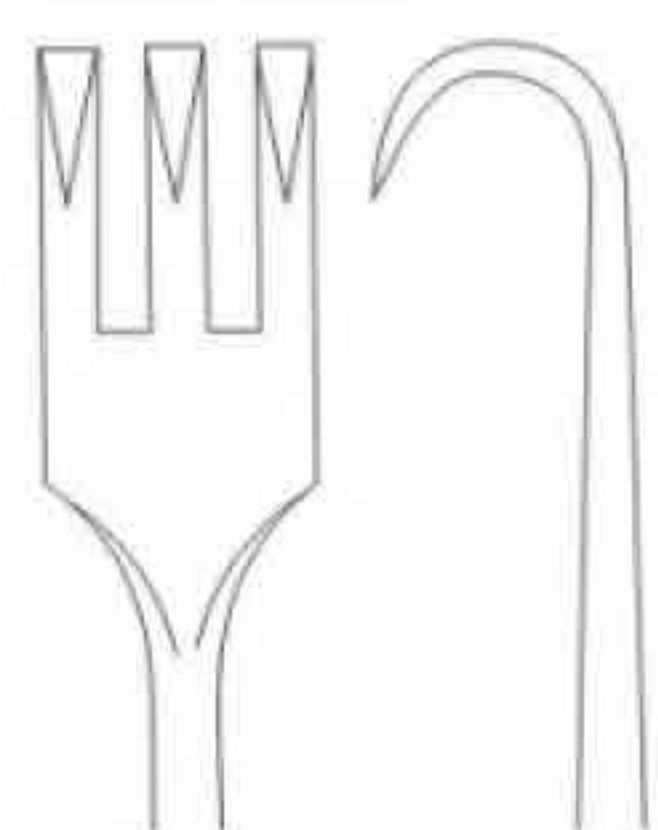


SAWEEZ SAWEEZ

SAWEEZ SAWEEZ



Senn-Mueller
16.0 cm / 6¼"



SSC-11-19-78
7 x 8.5 mm

sharp

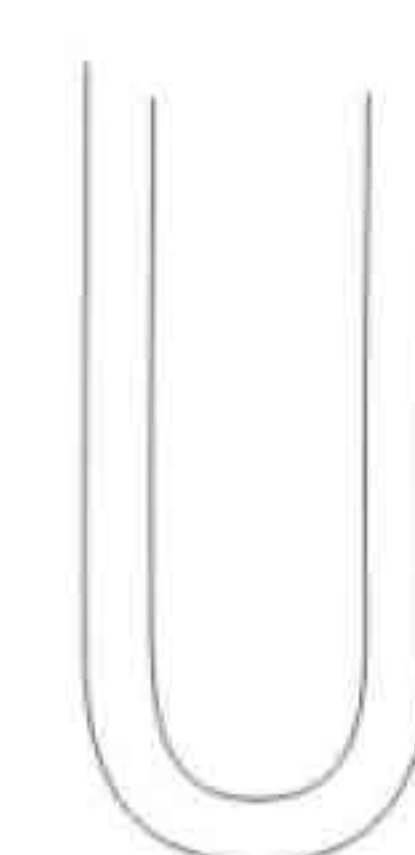


SSC-11-19-79
7 x 8.5 mm

blunt



Cushing



SSC-11-19-80
20.0 cm / 8"

SAWEEZ SAWEEZ

SAWEEZ SAWEEZ



SAWEEZ SAWEEZ SAWEEZ SAWEEZ



Cushing
20.0 cm / 8"



SSC-11-19-81
8 mm



SSC-11-19-82
10 mm



SSC-11-19-83
12 mm



SSC-11-19-84
14 mm



SSC-11-19-85
16 mm



SSC-11-19-86
18 mm



Cushing
24.0 cm / 9½"



SSC-11-19-87
8 mm



SSC-11-19-88
10 mm



SSC-11-19-89
12 mm



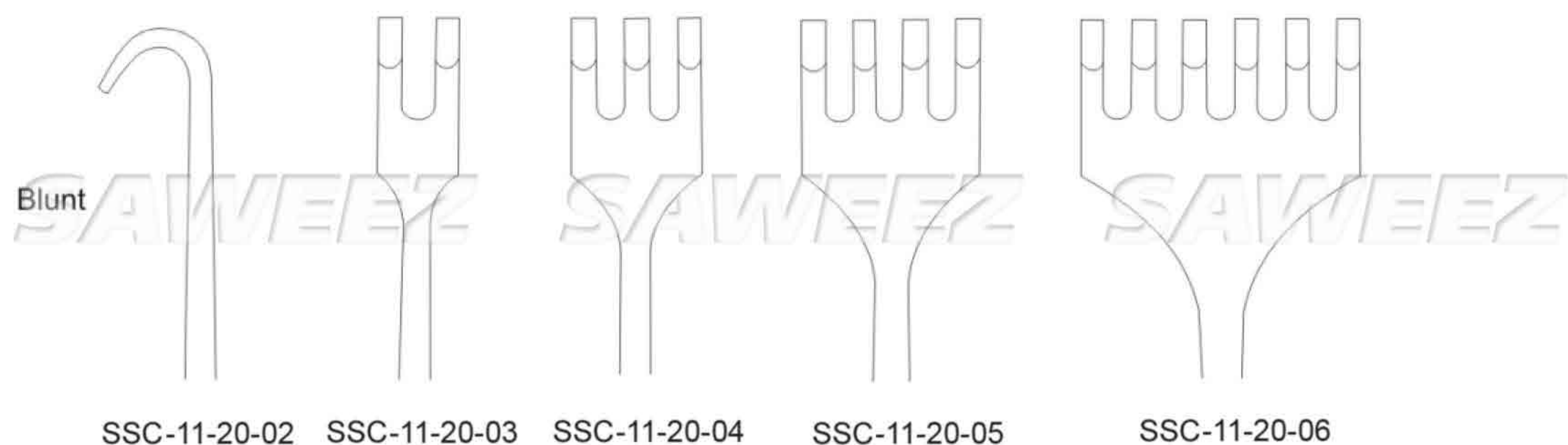
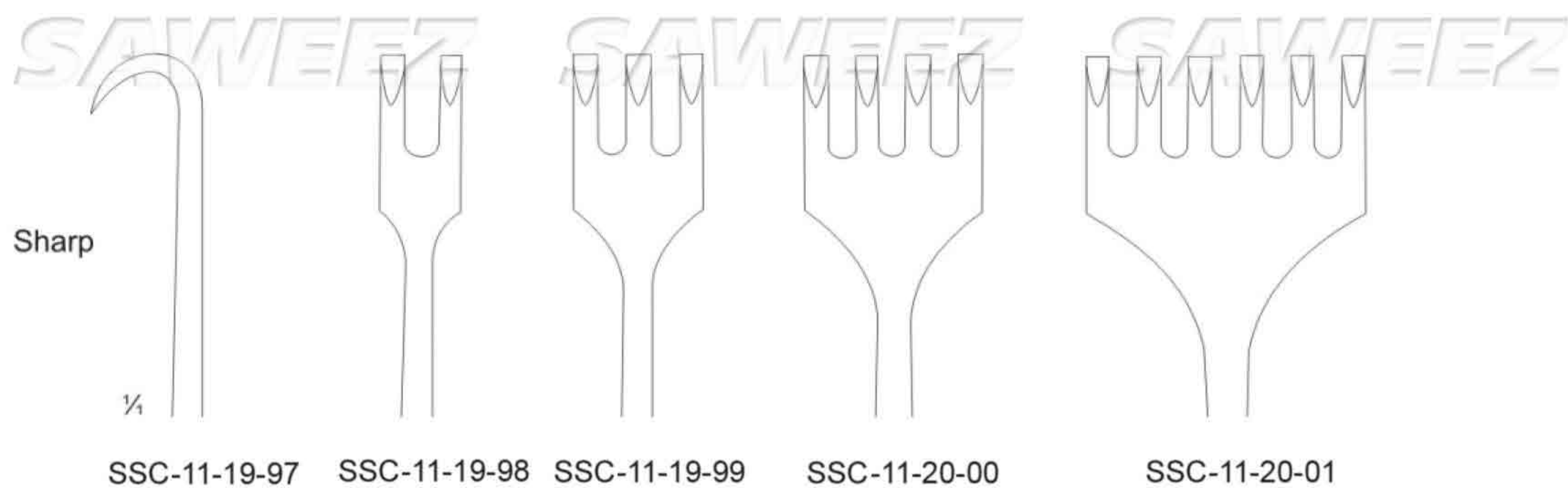
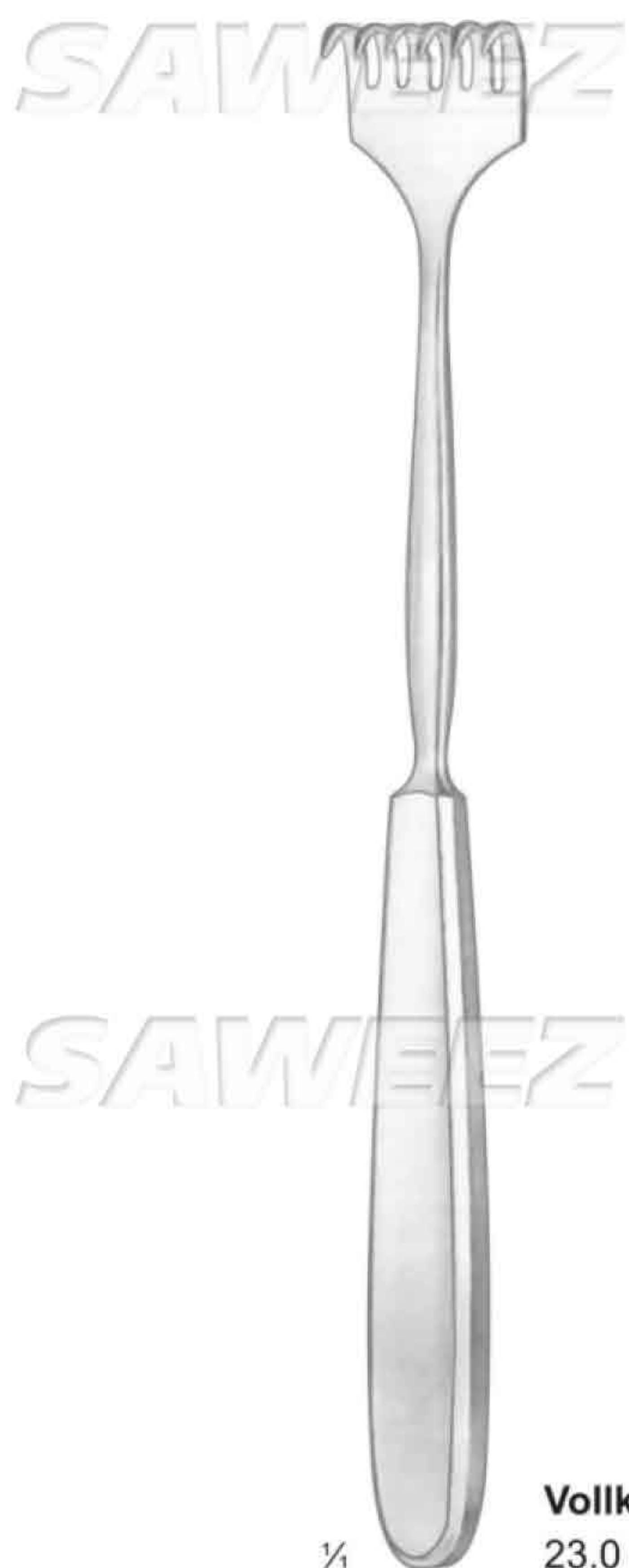
SSC-11-19-90
14 mm



SSC-11-19-91
16 mm

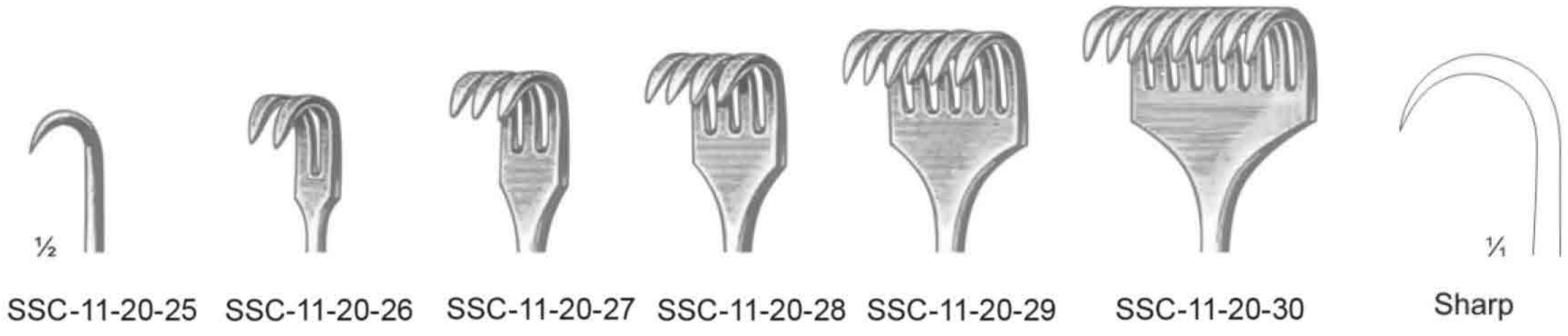


SSC-11-19-92
18 mm

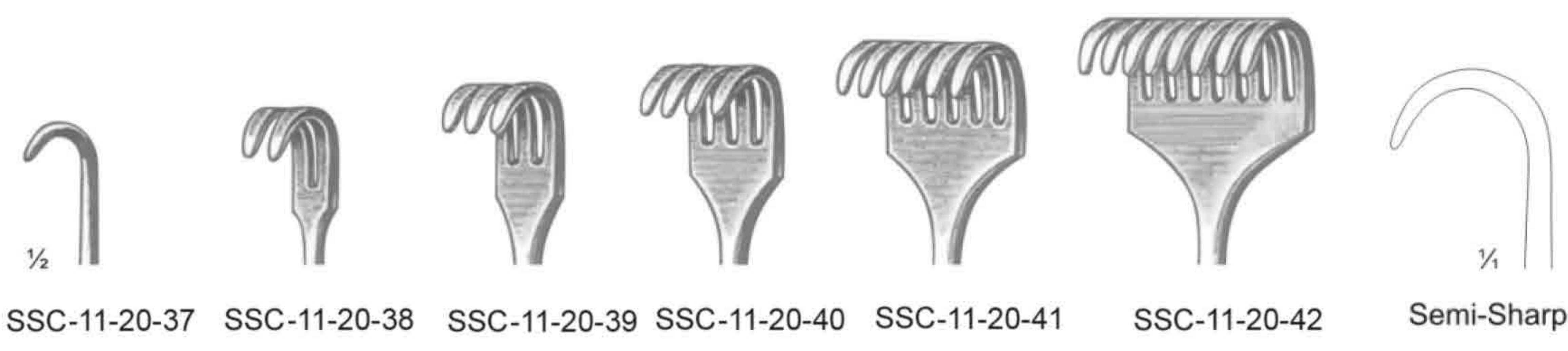
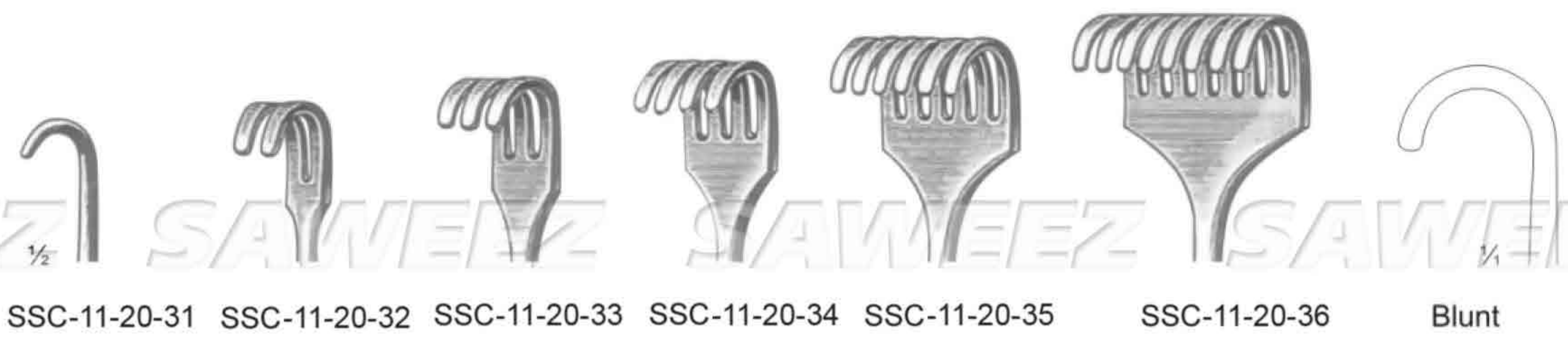




SAWEEZ SAWEEZ SAWEEZ SAWEEZ



SAWEEZ SAWEEZ SAWEEZ SAWEEZ



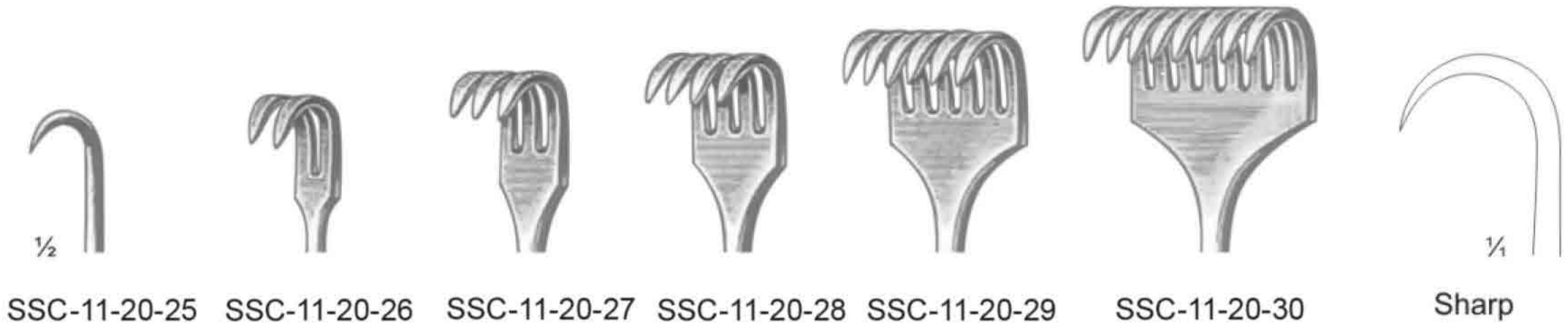
SAWEEZ SAWEEZ SAWEEZ SAWEEZ



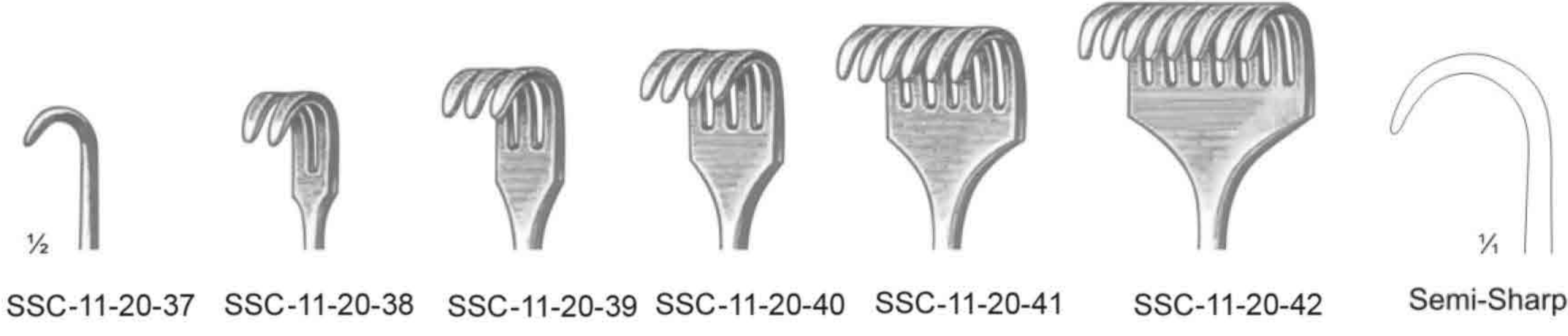
$\frac{1}{2}$
Kocher
22.0 cm / 8 $\frac{3}{4}$ "



SAWEEZ SAWEEZ SAWEEZ SAWEEZ



SAWEEZ SAWEEZ SAWEEZ SAWEEZ



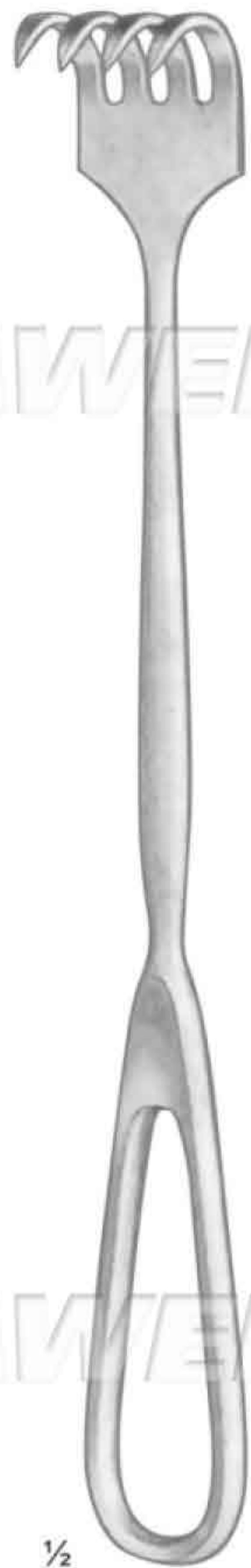
SAWEEZ SAWEEZ SAWEEZ SAWEEZ



Kocher
22.0 cm / 8 $\frac{3}{4}$ "



SAWEEZ SAWEEZ SAWEEZ SAWEEZ



1/2

Special Model
22.0 cm / 8 3/4"



1/2

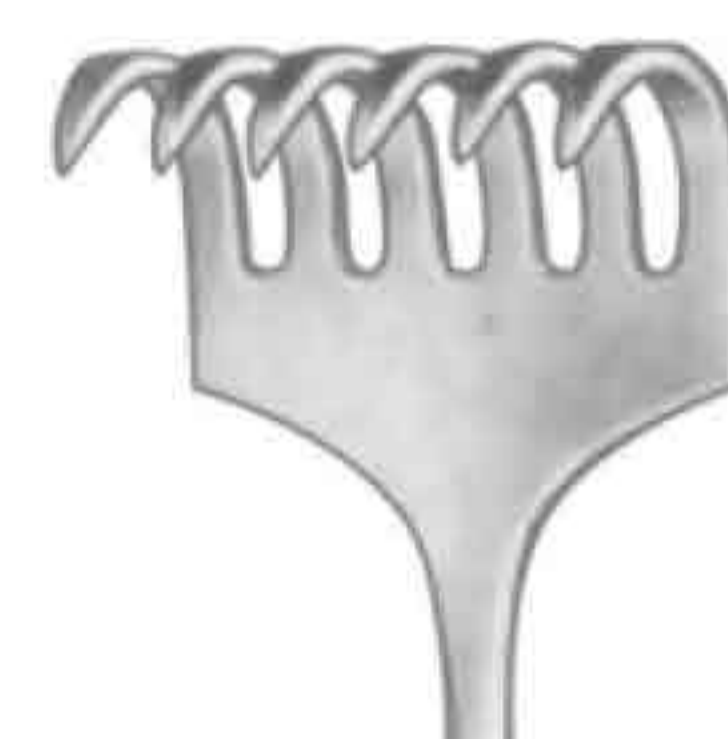
SSC-11-20-43



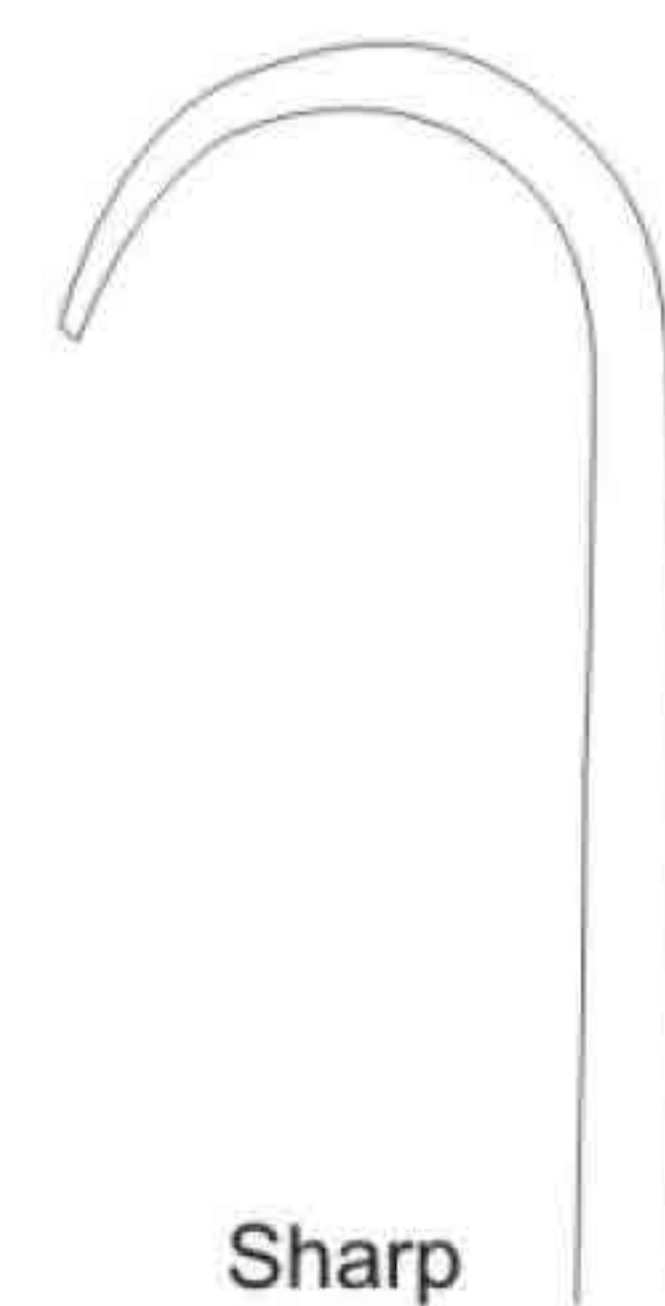
SSC-11-20-44



SSC-11-20-45



SSC-11-20-46



Sharp

1/4

SAWEEZ SAWEEZ SAWEEZ SAWEEZ

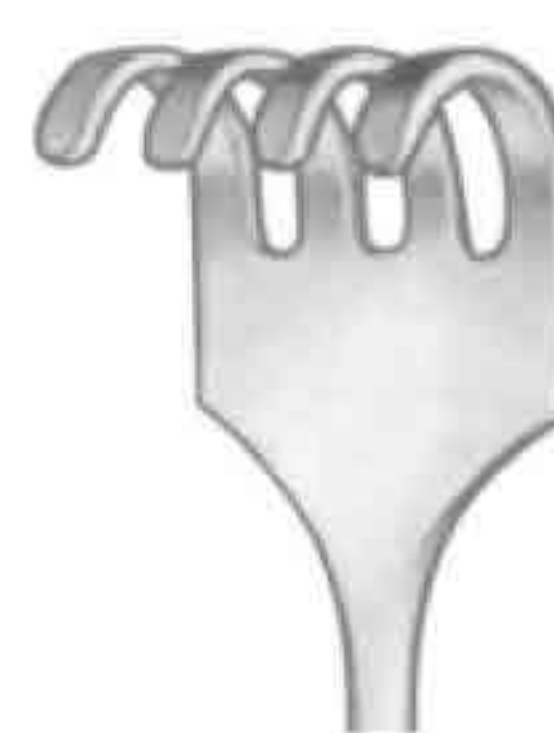


1/2

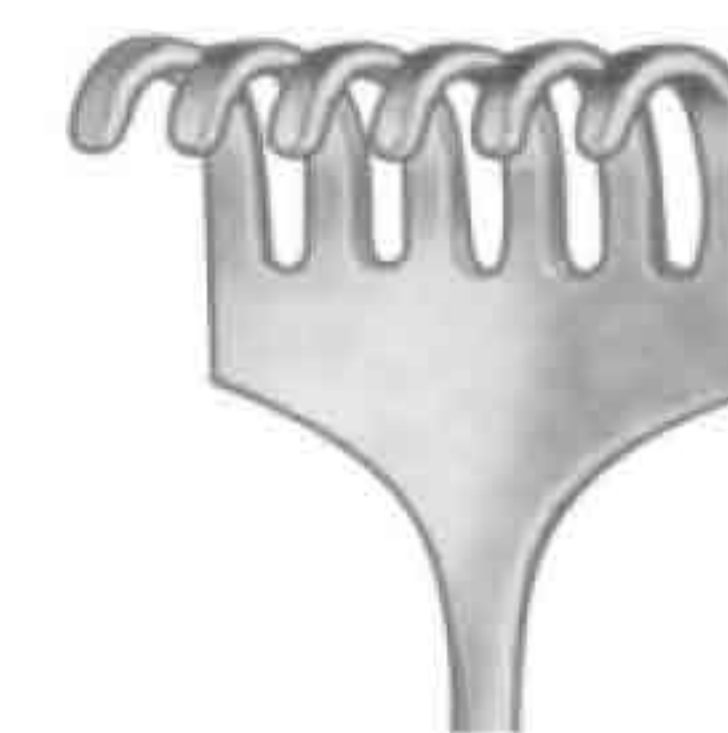
SSC-11-20-47



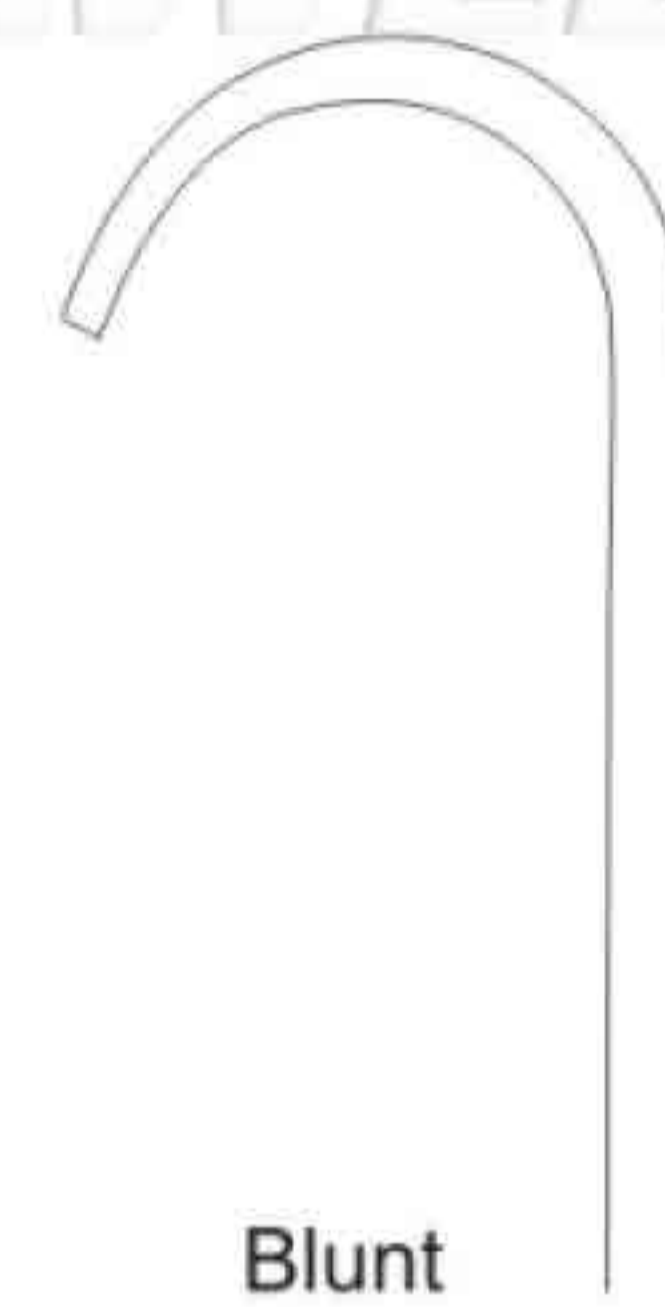
SSC-11-20-48



SSC-11-20-49



SSC-11-20-50



Blunt

1/4

SAWEEZ SAWEEZ SAWEEZ SAWEEZ

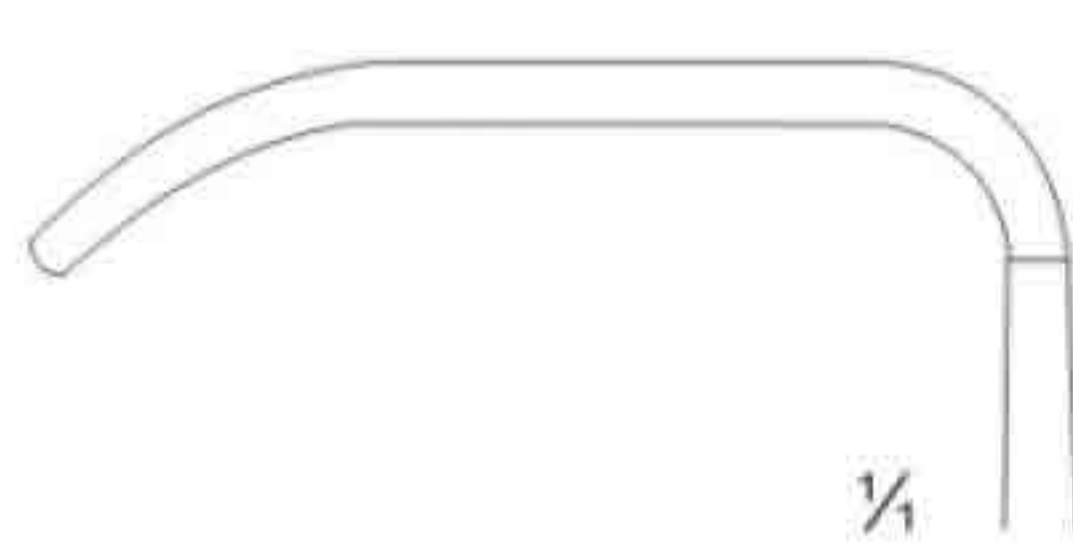


SAWEEZ SAWEEZ SAWEEZ SAWEEZ



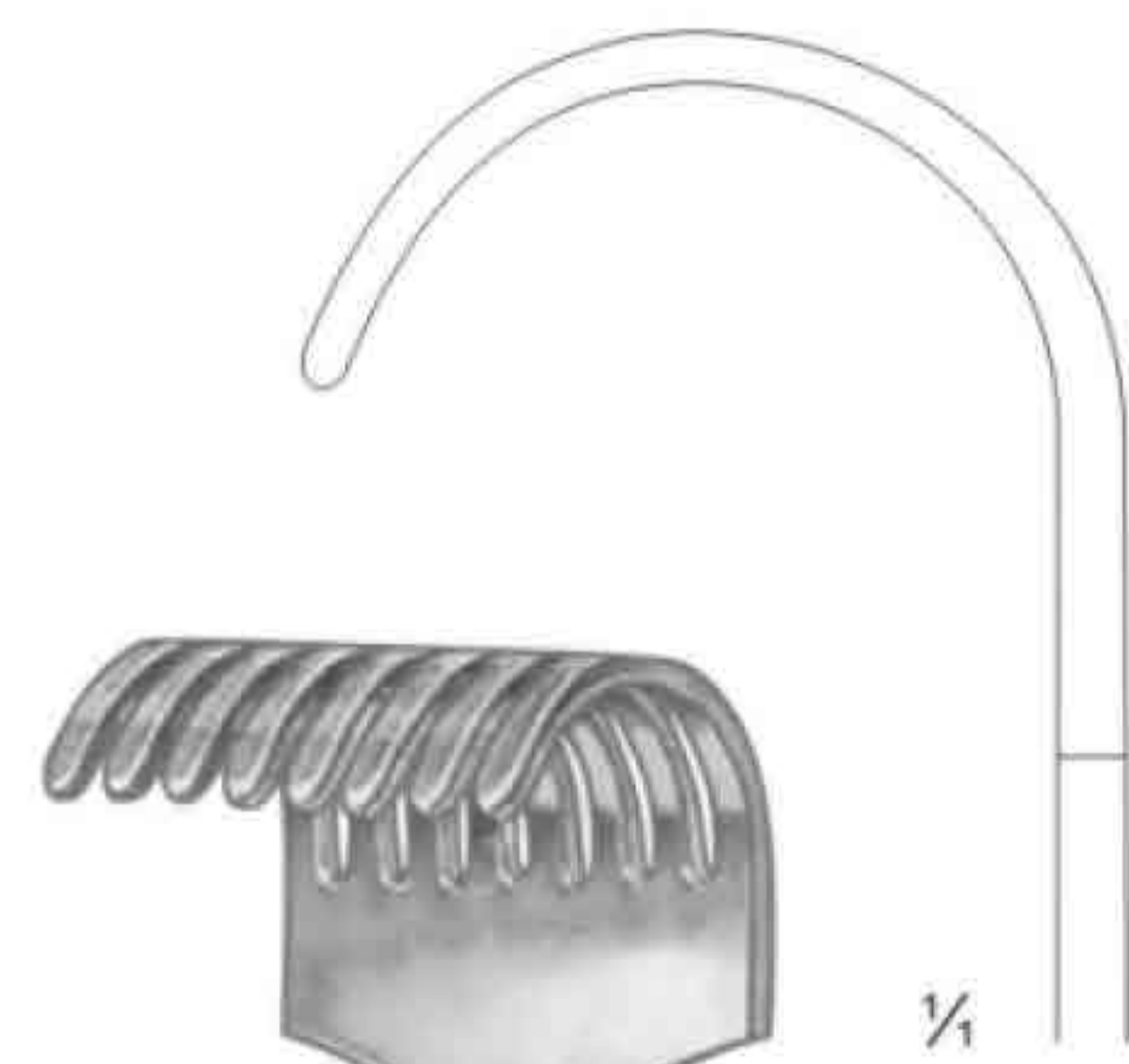
SSC-11-20-52
36 x 60 mm

1/4



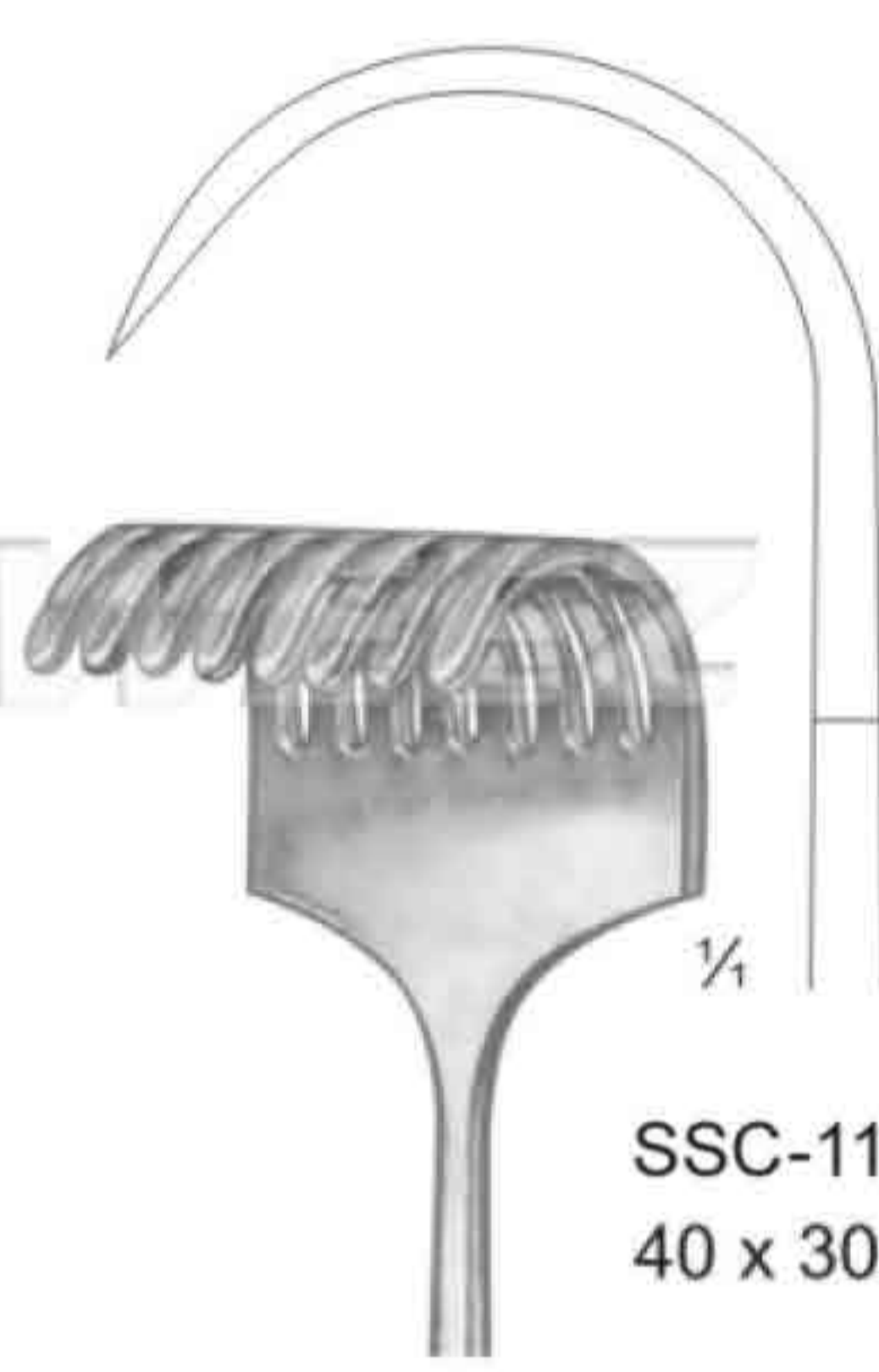
1/4

SSC-11-20-53
20.0 cm / 8"
33 x 20 mm



1/4

SSC-11-20-55
40 x 30 mm
blunt



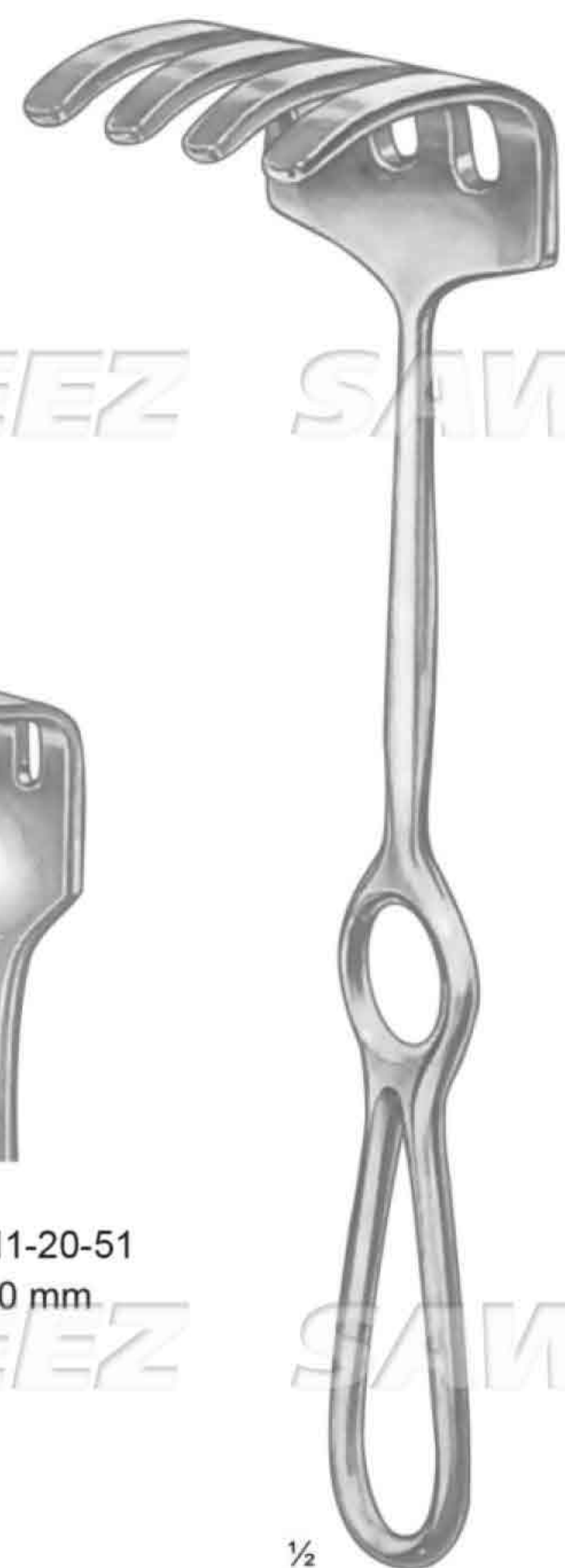
1/4

SSC-11-20-54
40 x 30 mm
sharp



1/2

SSC-11-20-51
36 x 30 mm



1/2

Ollier
22.5 cm / 9"



1/2

Wassmund



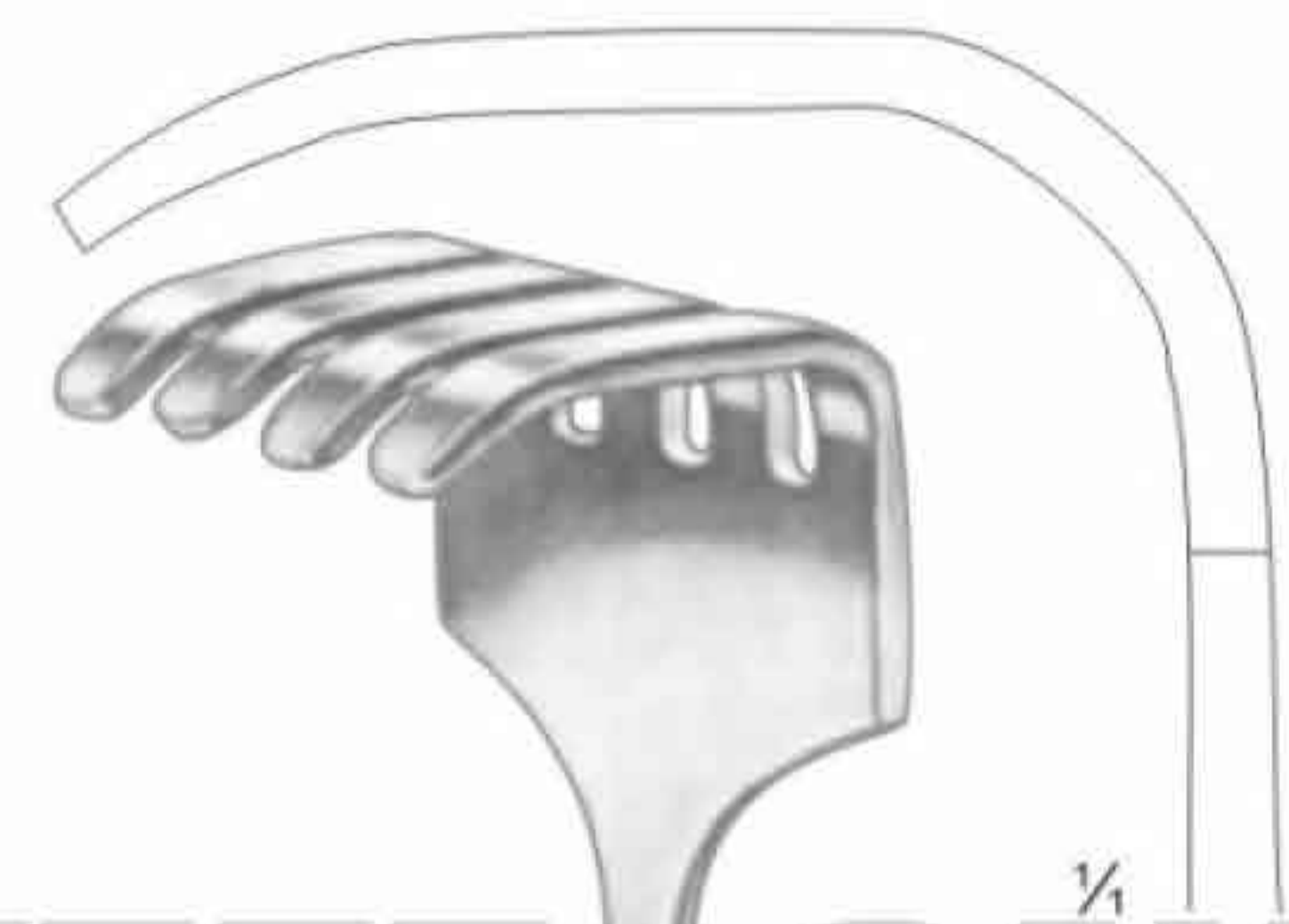
1/2

Koerte
23.5 cm / 9 1/4"

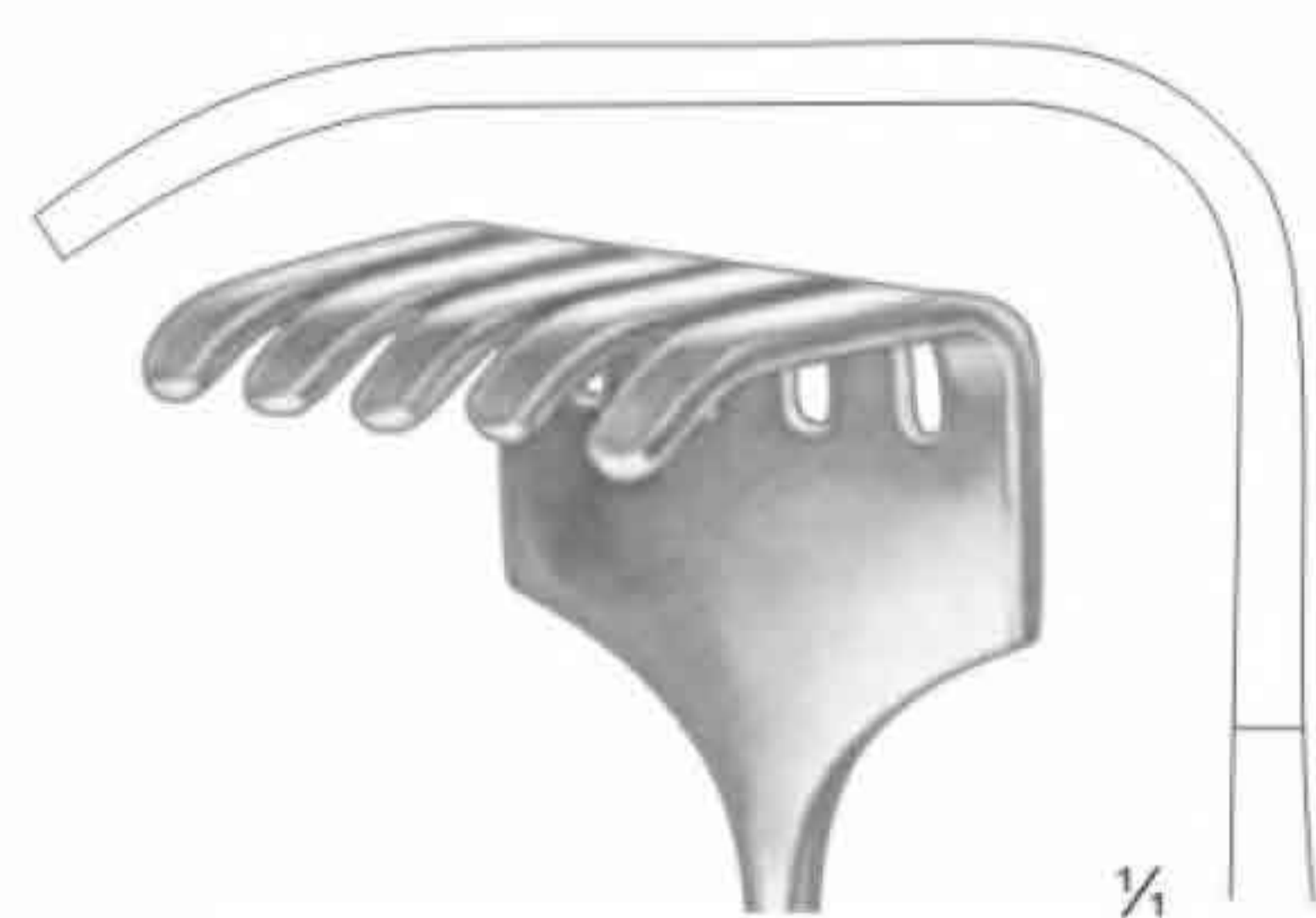
SAWEEZ SAWEEZ SAWEEZ SAWEEZ



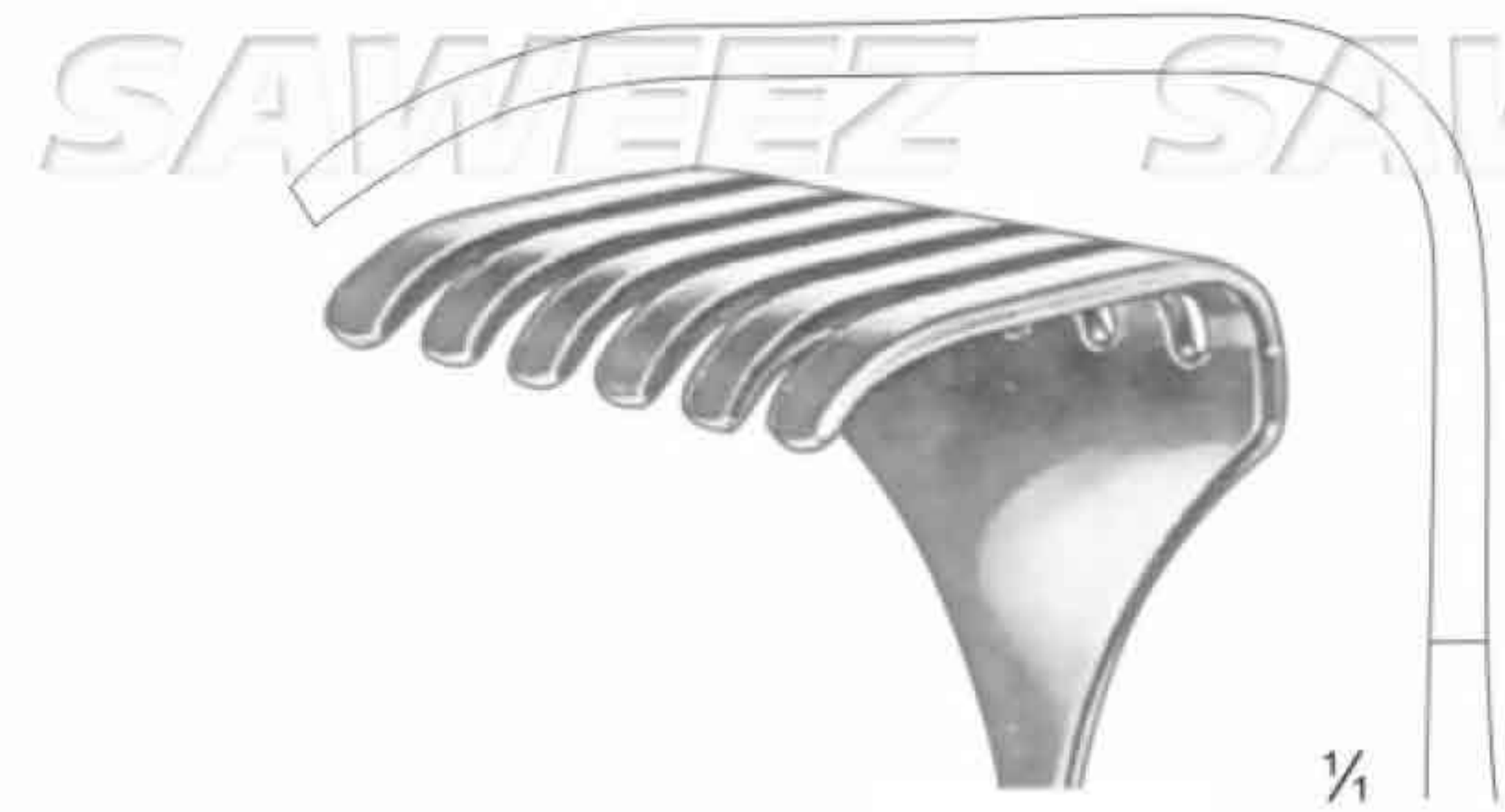
SAWEEZ SAWEEZ SAWEEZ SAWEEZ



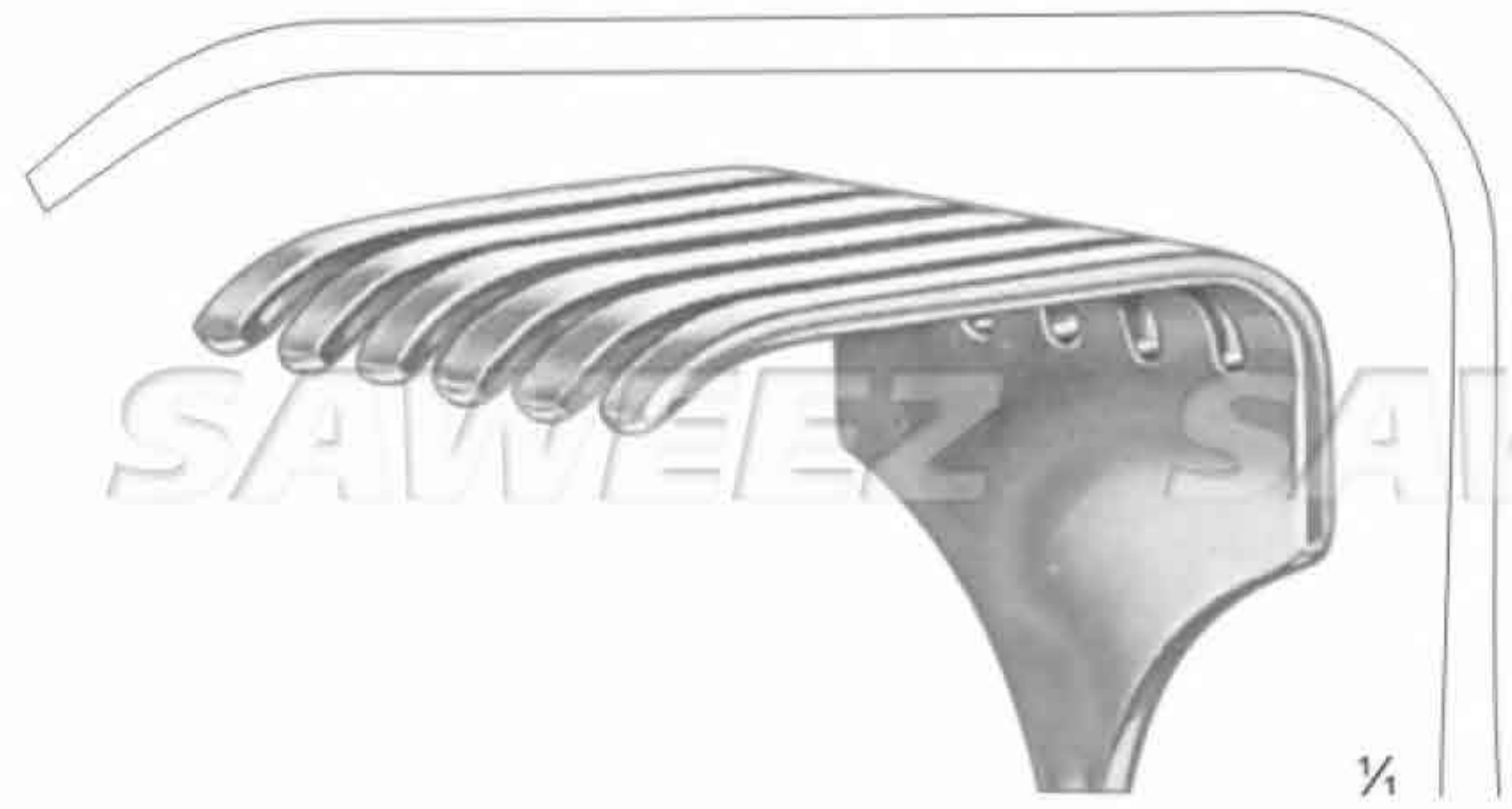
SSC-11-20-56
40 x 40 mm



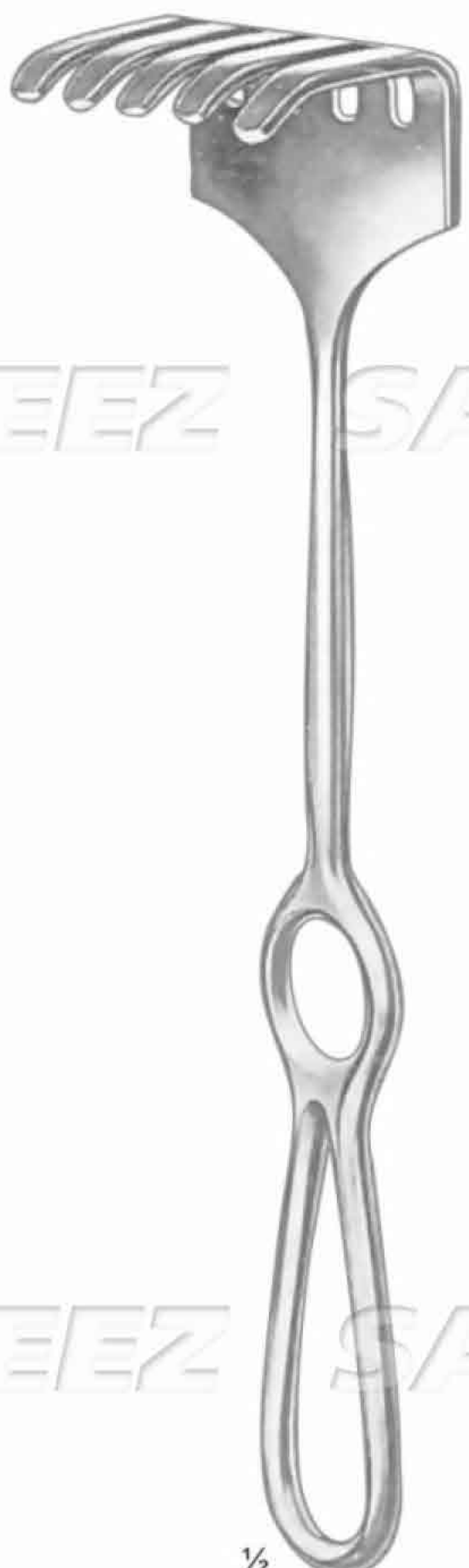
SSC-11-20-57
45 x 50 mm



SSC-11-20-58
50 x 60 mm



SSC-11-20-59
70 x 70 mm



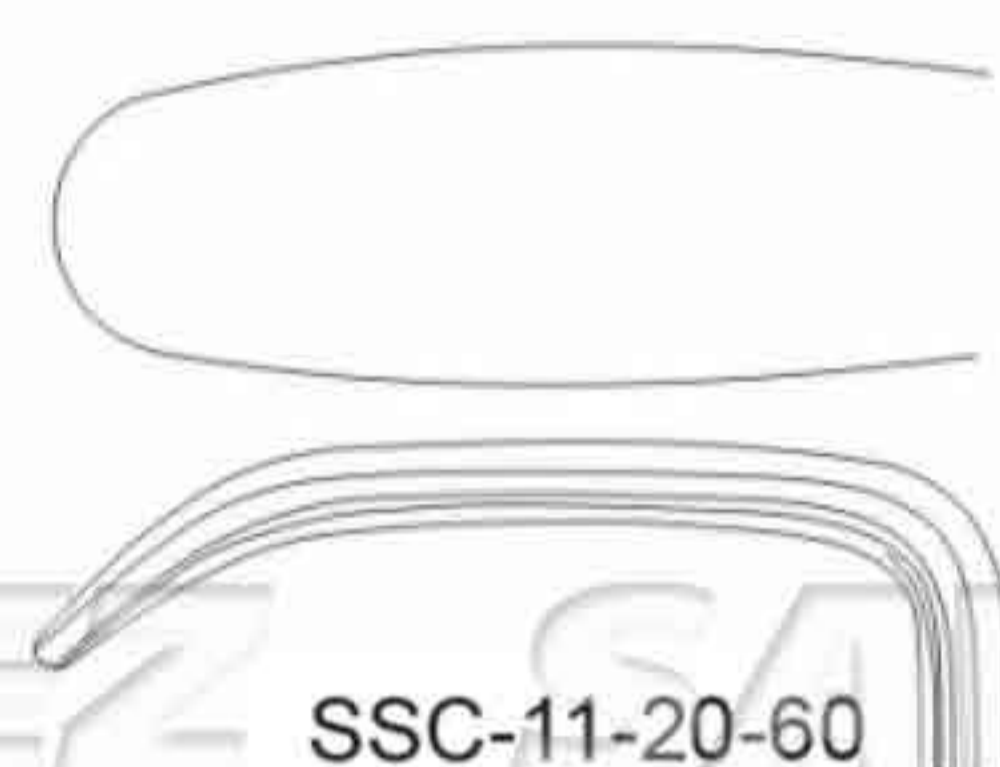
1/2
Israel
25.0 cm / 10"

SAWEEZ SAWEEZ SAWEEZ SAWEEZ

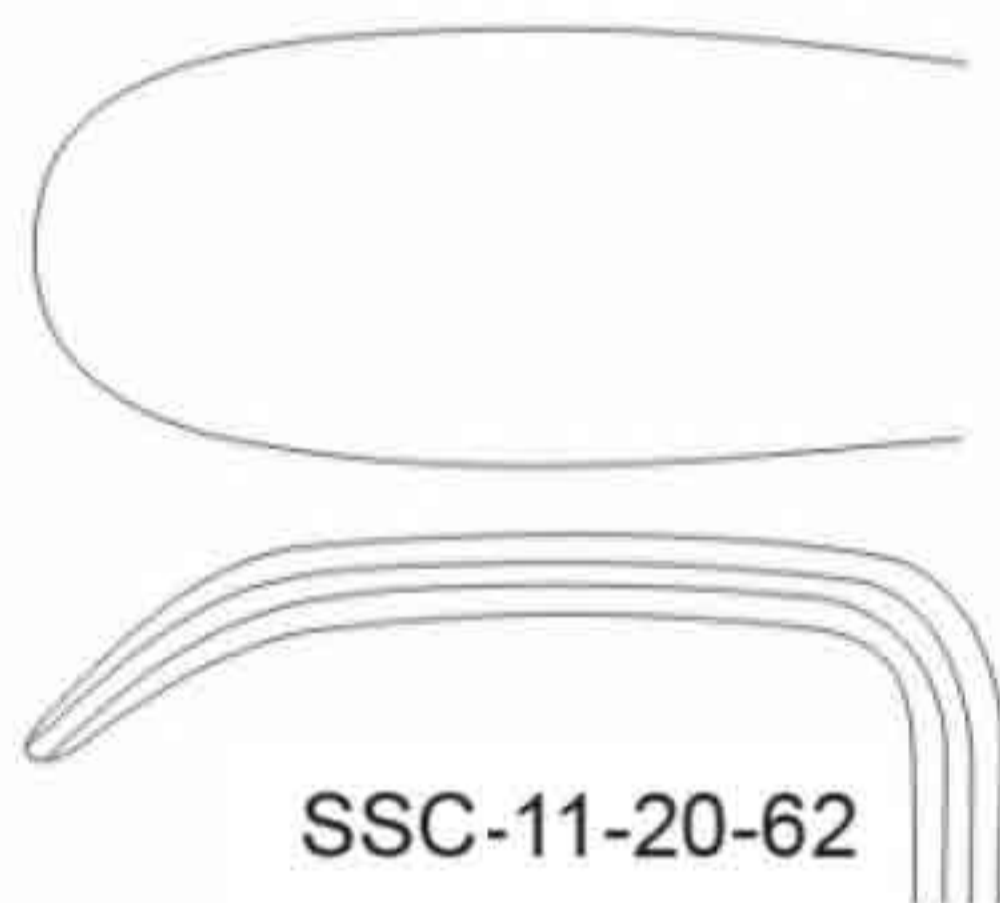
SAWEEZ SAWEEZ SAWEEZ SAWEEZ



SAWEEZ SAWEEZ SAWEEZ SAWEEZ



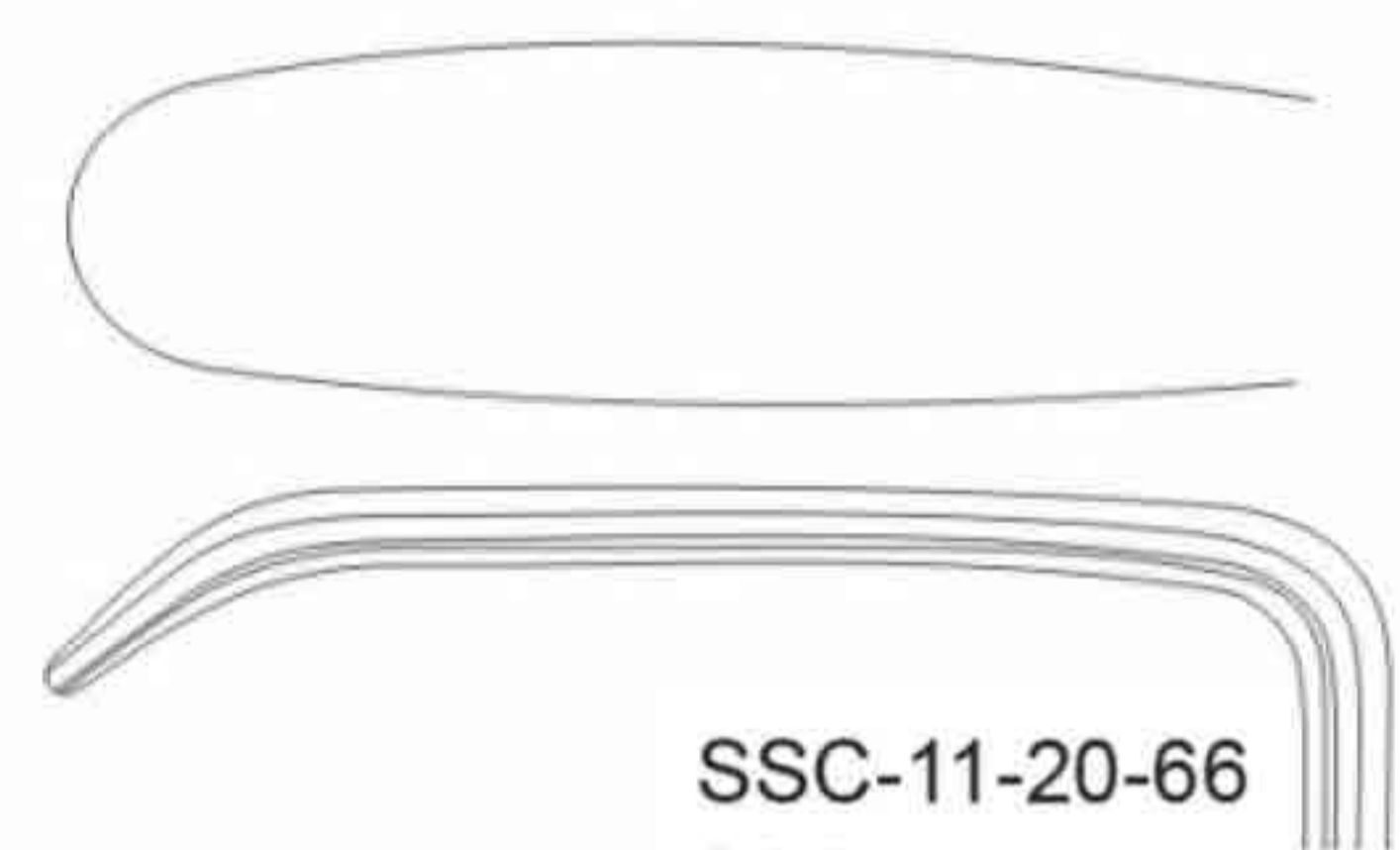
SSC-11-20-60
SSC-11-20-61
30 x 11 mm



SSC-11-20-62
SSC-11-20-63
30 x 14 mm



SSC-11-20-64
SSC-11-20-65
30 x 16 mm



SSC-11-20-66
SSC-11-20-67
40 x 11 mm



SSC-11-20-68
SSC-11-20-69
50 x 11 mm



½
Langenbeck
22.0 cm / 8½"



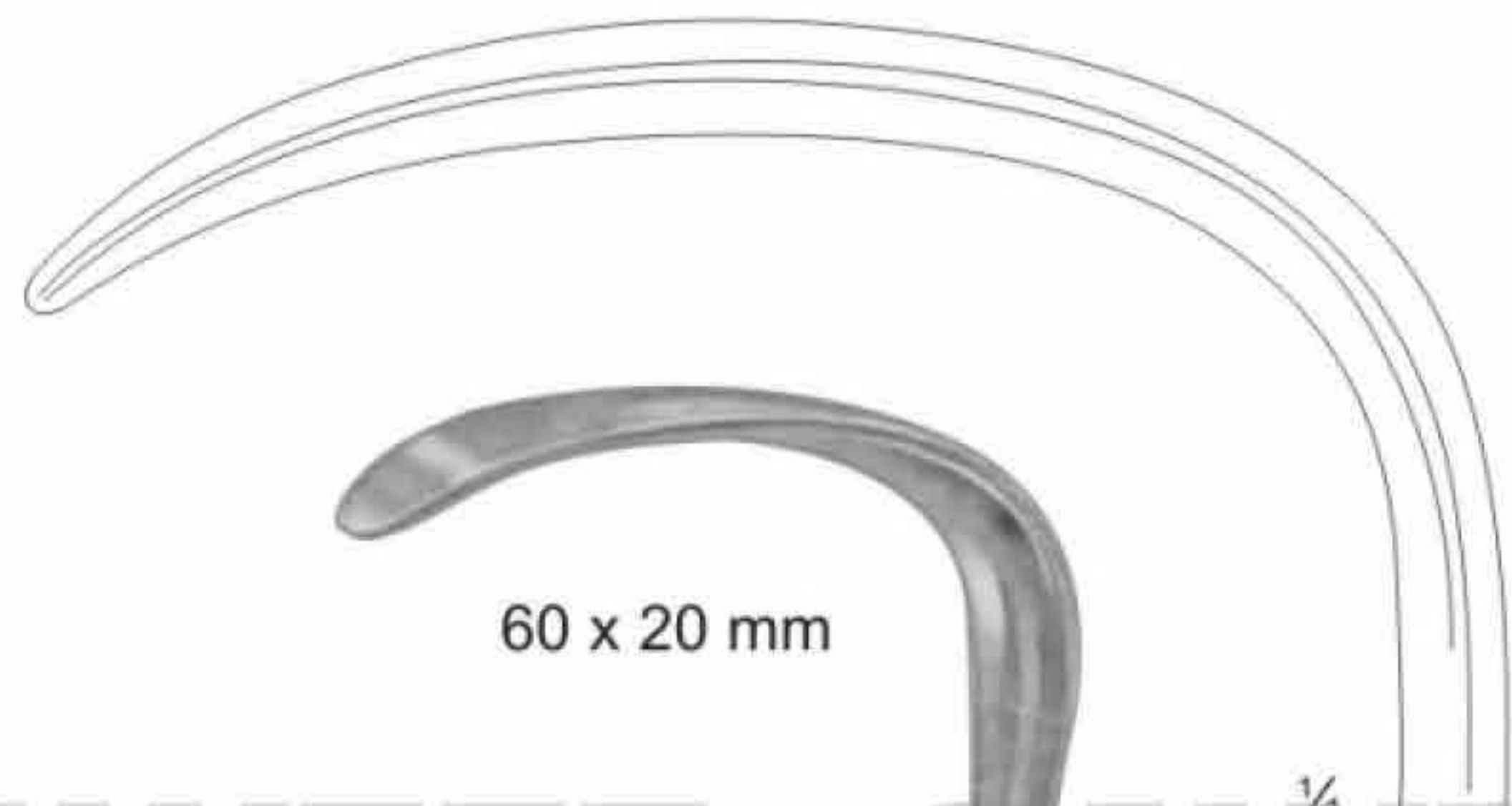
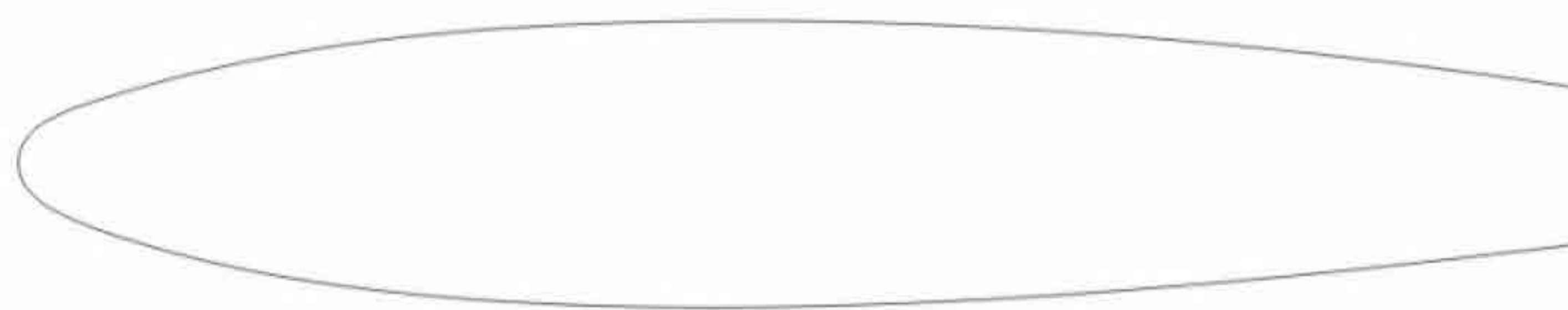
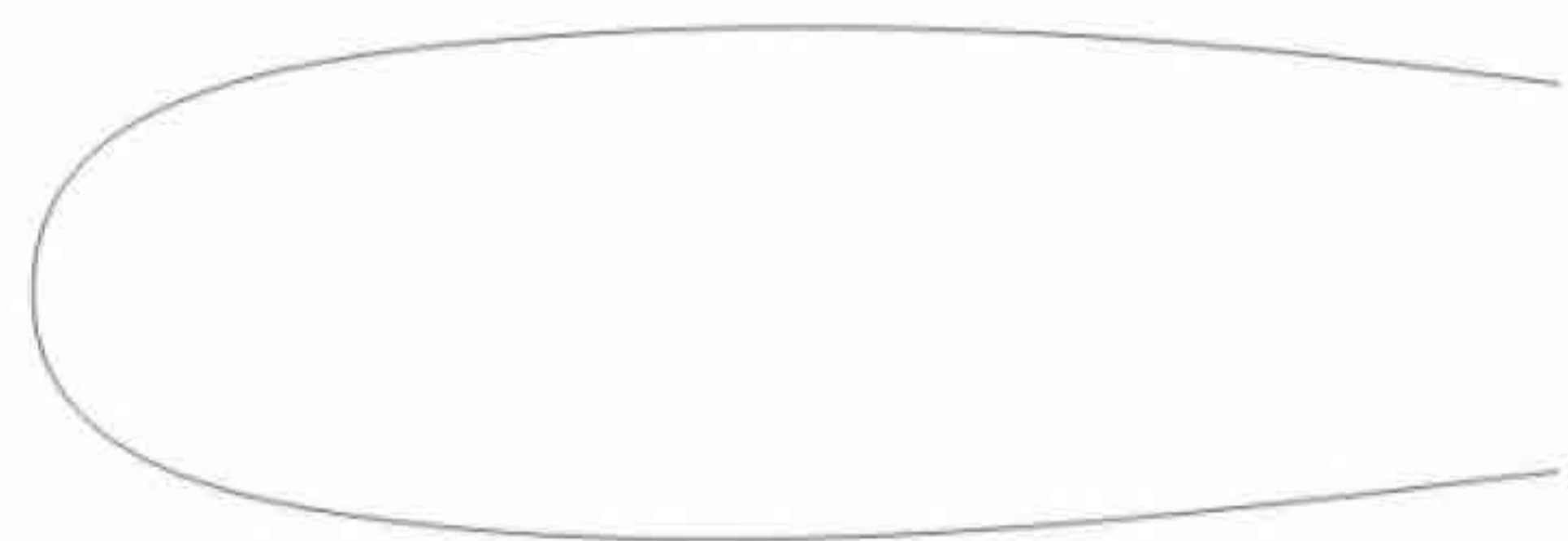
½
Langenbeck
20.0 cm / 8¼"

SAWEEZ SAWEEZ SAWEEZ SAWEEZ

SAWEEZ SAWEEZ SAWEEZ SAWEEZ



SAWEEZ SAWEEZ SAWEEZ SAWEEZ



60 x 20 mm

85 x 15 mm

SAWEEZ SAWEEZ SAWEEZ SAWEEZ



1/2

1/2

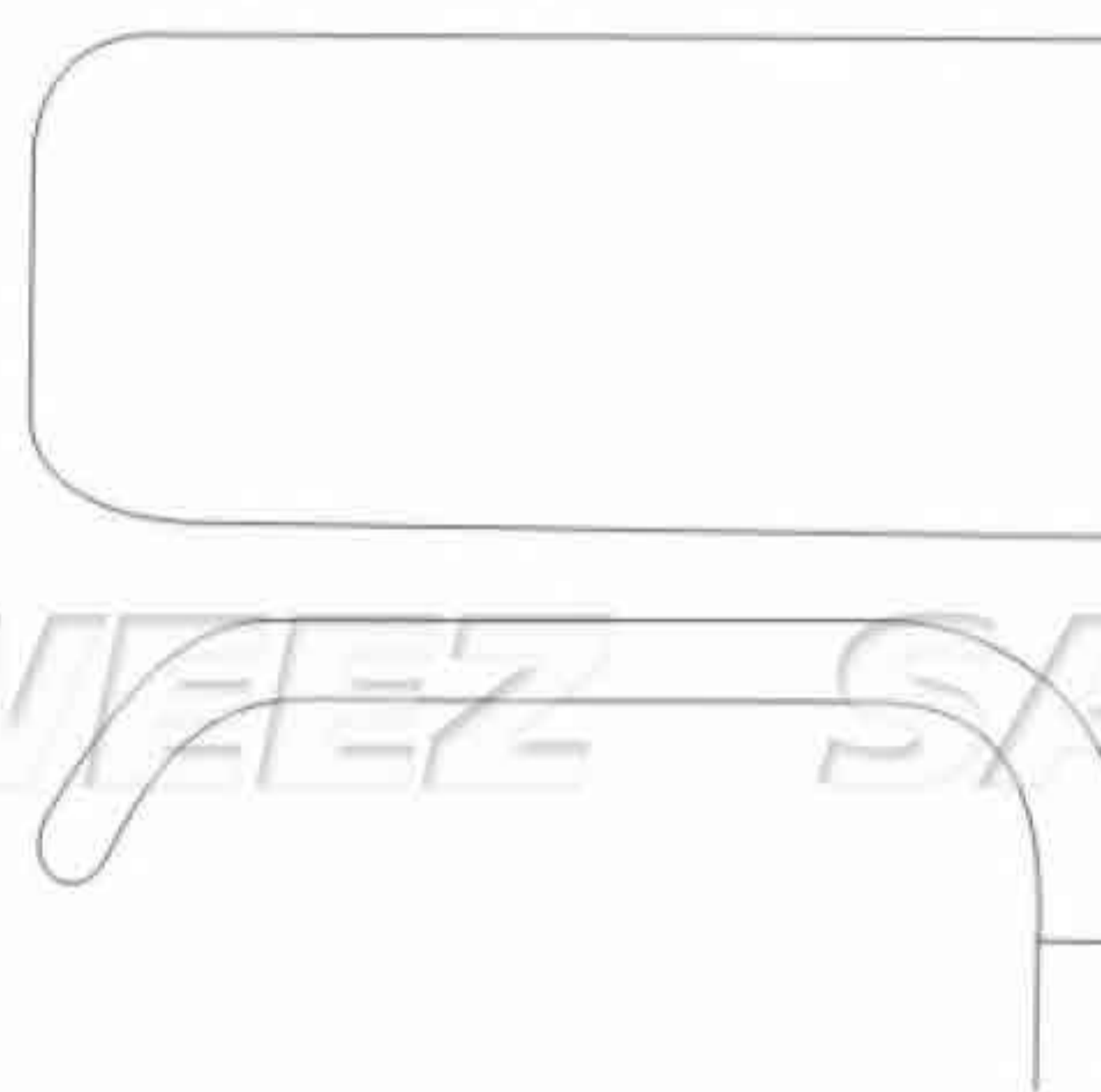
Langenbeck
SSC-11-20-70
21.0 cm / 8 1/4"

Langenbeck
SSC-11-20-71
21.0 cm / 8 1/2"

SAWEEZ SAWEEZ SAWEEZ SAWEEZ



SAWEEZ SAWEEZ SAWEEZ SAWEEZ



SSC-11-20-72
40 x 18 mm



1/2

Kocher
23.0 / 9"



SSC-11-20-73
60 x 20 mm

SAWEEZ SAWEEZ SAWEEZ SAWEEZ



SSC-11-20-74
60 x 25 mm

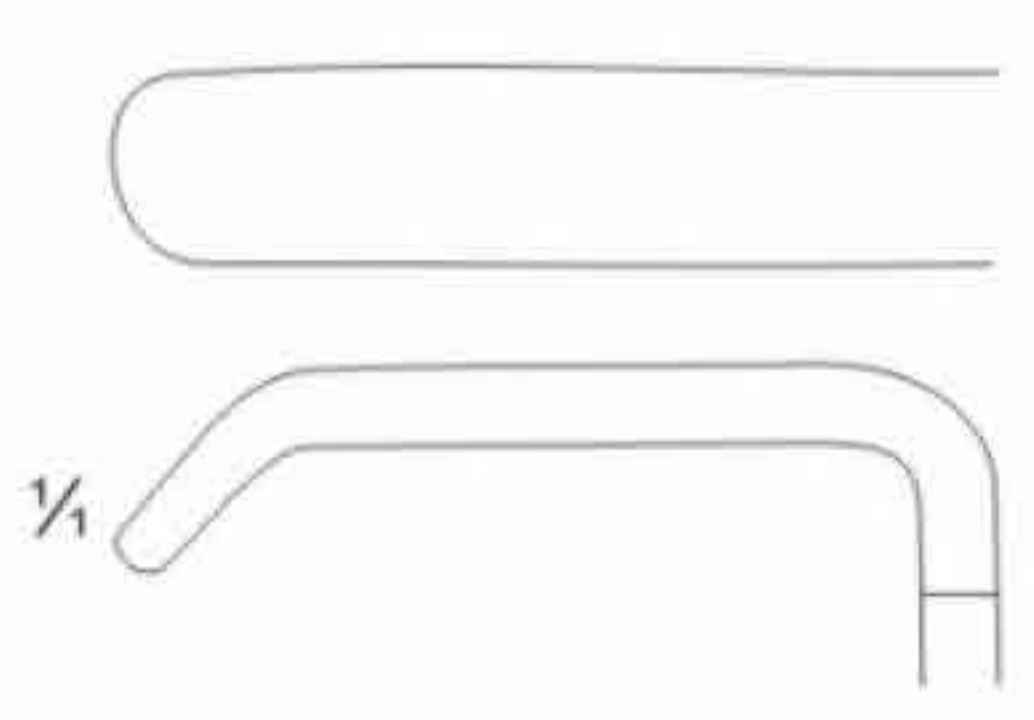
SAWEEZ SAWEEZ SAWEEZ SAWEEZ



SSC-11-20-75
75 x 30 mm



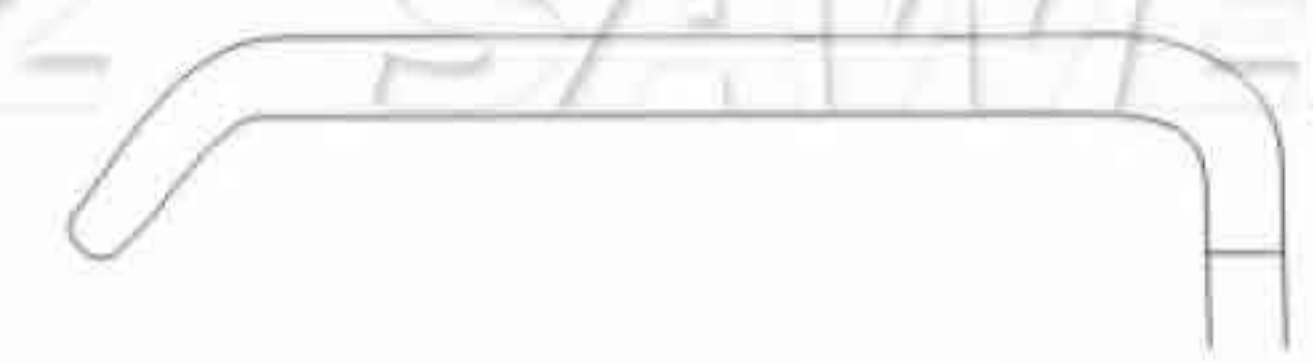
SSC-11-20-76
75 x 40 mm



SSC-11-20-77
26 x 6 mm



SSC-11-20-78
35 x 8 mm



SSC-11-20-79
35 x 11 mm



SSC-11-20-80
35 x 15 mm



SSC-11-20-81
40 x 11 mm



SSC-11-20-82
55 x 11 mm



SSC-11-20-83
70 x 14 mm



SSC-11-20-84
80 x 12 mm



SSC-11-20-85
80 x 16 mm



Kocher-Langenbeck
21.5 / 8½"

SAWEEZ SAWEEZ SAWEEZ SAWEEZ

SAWEEZ SAWEEZ SAWEEZ SAWEEZ

SAWEEZ SAWEEZ SAWEEZ SAWEEZ



49 x 38 mm
28 x 20 mm

Fig. 1 ▶

◀ Fig. 2

SSC-11-20-89
28 x 20 mm

52 x 22 mm

65 x 50 mm

36 x 28 mm
71 x 43 mm

SSC-11-20-90
36 x 28 mm

SSC-11-20-91
44 x 38 mm

Richardson-Eastmann
SSC-11-20-86 - set of two (2+3)
SSC-11-20-87 - Fig.1 = 26.0 cm / 10¼"
SSC-11-20-88 - Fig.2 = 28.0 cm / 11"

Richardson
24.0 cm / 9½"

Richardson
SSC-11-20-92
24.0 cm / 9½"

Kelly
SSC-11-20-93
26.0 cm / 10¼"



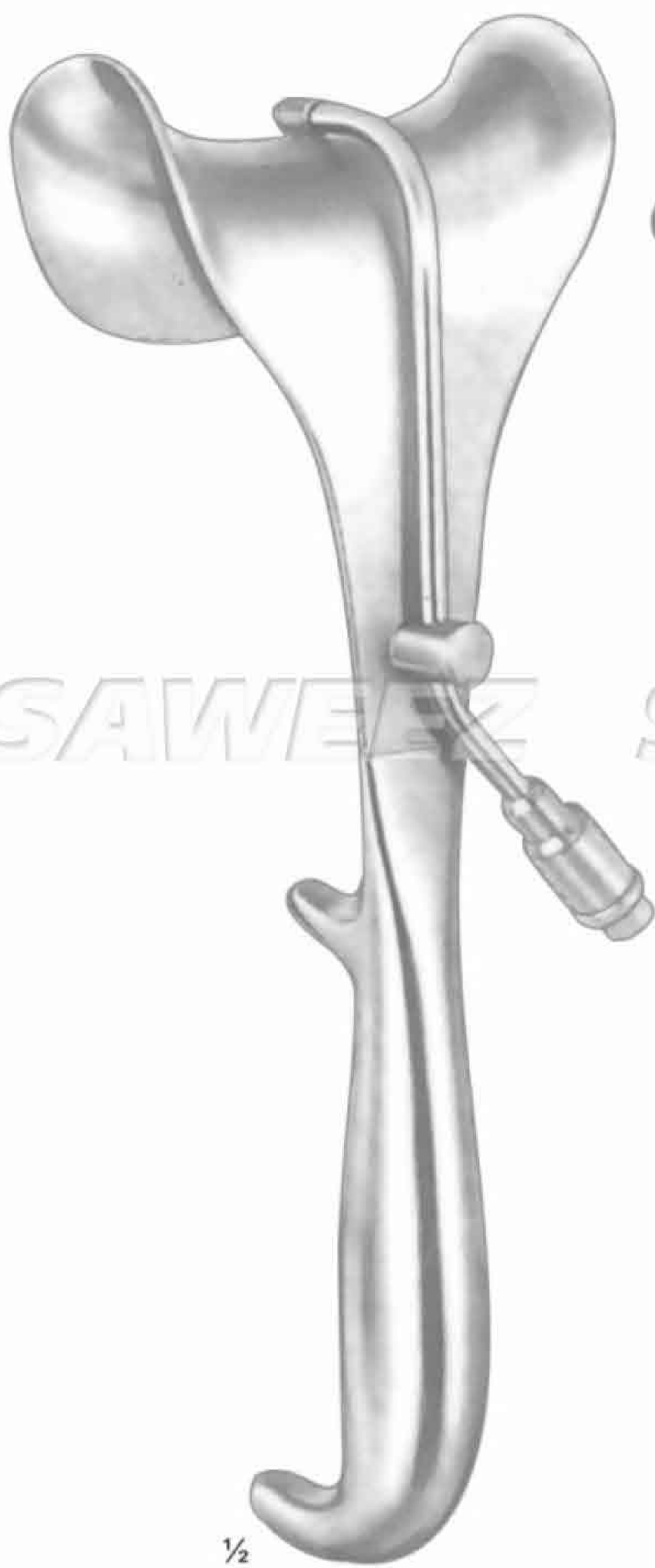
SAWEEZ SAWEEZ SAWEEZ SAWEEZ



50 x 85 mm

1/2

Doyen
SSC-11-20-94
25.0 cm / 10"



1/2

Doyen
SSC-11-20-95
25.0 cm / 10"



50 x 85 mm

1/2

Kocher
SSC-11-20-96
22.5 cm / 9"

1/2

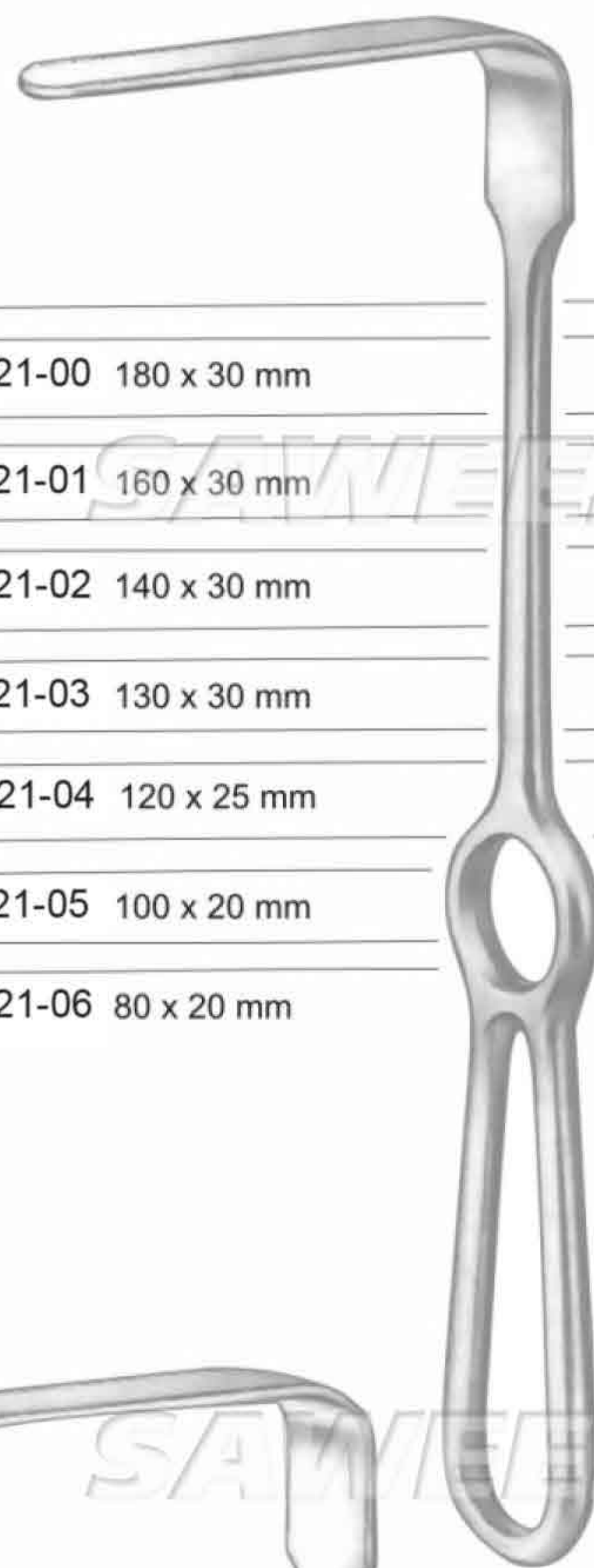
Kocher
25.0 cm / 10"
SSC-11-20-97 - 80 x 45 mm
SSC-11-20-98 - 80 x 55 mm
SSC-11-20-99 - 80 x 65 mm

SAWEEZ SAWEEZ SAWEEZ SAWEEZ

SAWEEZ SAWEEZ SAWEEZ SAWEEZ



- SSC-11-21-00 180 x 30 mm
- SSC-11-21-01 160 x 30 mm
- SSC-11-21-02 140 x 30 mm
- SSC-11-21-03 130 x 30 mm
- SSC-11-21-04 120 x 25 mm
- SSC-11-21-05 100 x 20 mm
- SSC-11-21-06 80 x 20 mm



Brunner
25.0 cm / 10"

¼

- SSC-11-21-07 180 x 30 mm
- SSC-11-21-08 160 x 30 mm
- SSC-11-21-09 140 x 25 mm
- SSC-11-21-10 120 x 25 mm
- SSC-11-21-11 100 x 20 mm
- SSC-11-21-12 80 x 20 mm



Brunner
25.0 cm / 10"

¼



SSC-11-21-13
127 x 40 mm

SSC-11-21-14
127 x 62 mm

Harrington
32.0 cm / 12½"

SAWEEZ SAWEEZ SAWEEZ SAWEEZ

SAWEEZ SAWEEZ SAWEEZ SAWEEZ

SAWEEZ SAWEEZ SAWEEZ SAWEEZ



Deaver
SSC-11-21-15
21.5 cm / 8½"

Deaver
SSC-11-21-16
23.0 cm / 9"

Deaver
SSC-11-21-17
30.0 cm / 12"

Deaver
SSC-11-21-18
33.0 cm / 13"

Deaver
SSC-11-21-19
36.0 cm / 14"



SAWEEZ SAWEEZ SAWEEZ SAWEEZ



38 mm

1/2

Deaver
SSC-11-21-20
30.0 cm / 12"



50 mm

1/2

Deaver
SSC-11-21-21
30.0 cm / 12"



75 mm

1/2

Deaver
SSC-11-21-22
30.0 cm / 12"

SAWEEZ SAWEEZ SAWEEZ SAWEEZ

SAWEEZ SAWEEZ SAWEEZ SAWEEZ



1/2

Deaver
31.0 cm / 12 1/4"



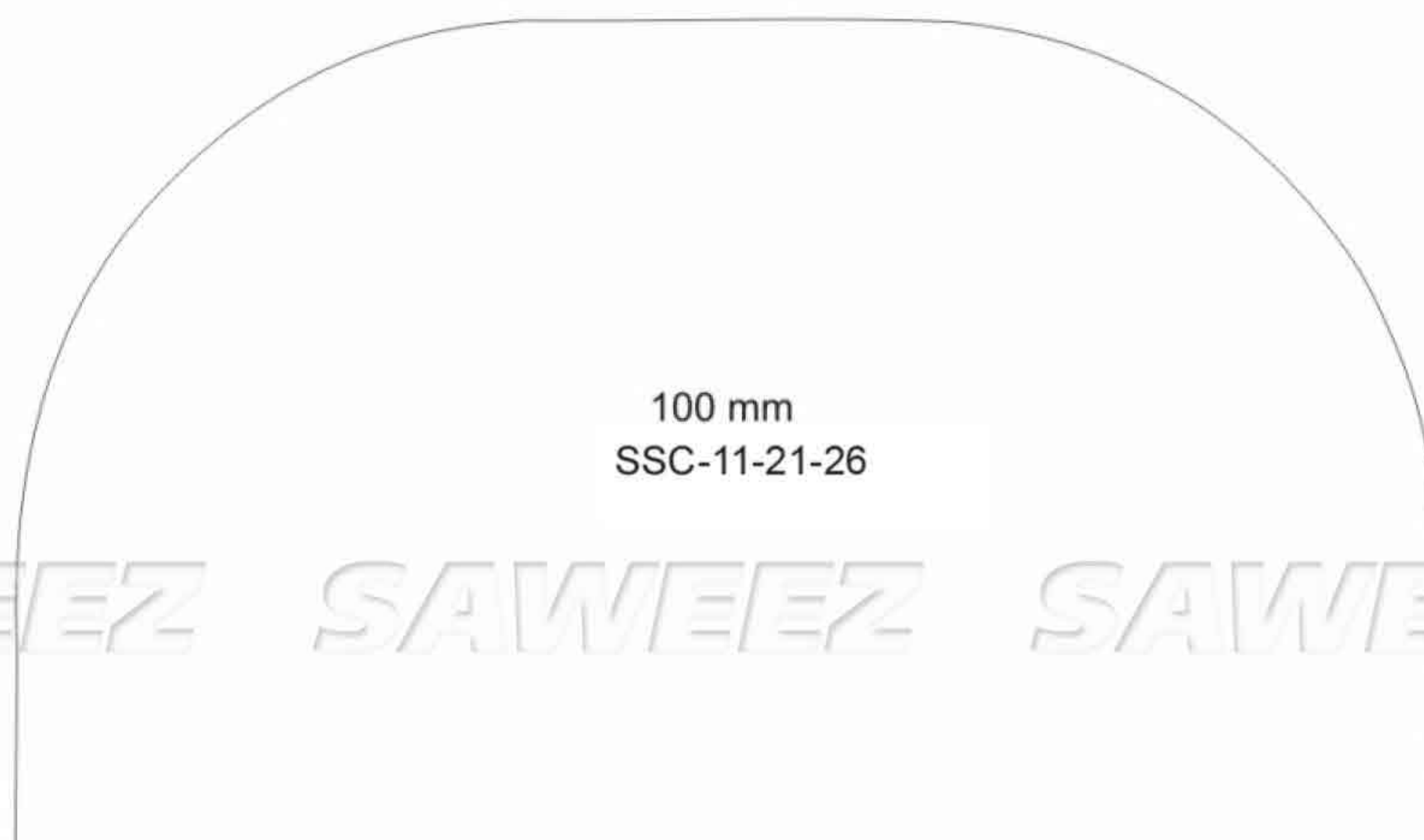
25 mm
SSC-11-21-23



38 mm
SSC-11-21-24

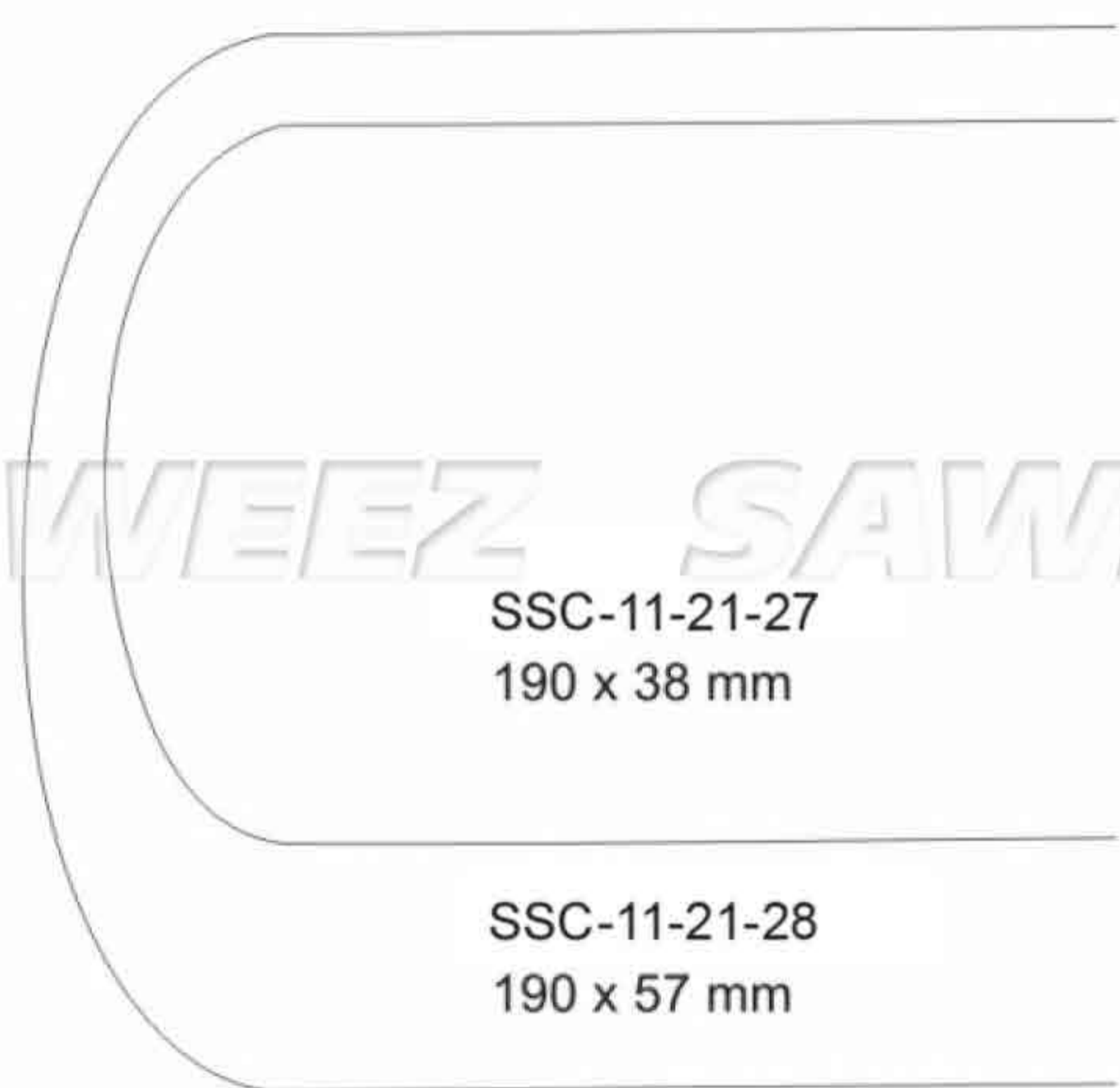


50 mm
SSC-11-21-25



100 mm
SSC-11-21-26

1/4



SSC-11-21-27
190 x 38 mm

SSC-11-21-28
190 x 57 mm



$\frac{1}{2}$ **Kelly**
27.0 cm / 10 $\frac{1}{2}$ "



Roux
SSC-11-21-29 - Set of three 3 (Fig. 1-3)
SSC-11-21-30 - Fig. 1 = 14.0 cm / 5 $\frac{1}{2}$ "
SSC-11-21-31 - Fig. 2 = 15.0 cm / 6"
SSC-11-21-32 - Fig. 3 = 17.0 cm / 6 $\frac{3}{4}$ "
SSC-11-21-33 - Fig. 4 = 18.0 cm / 7"

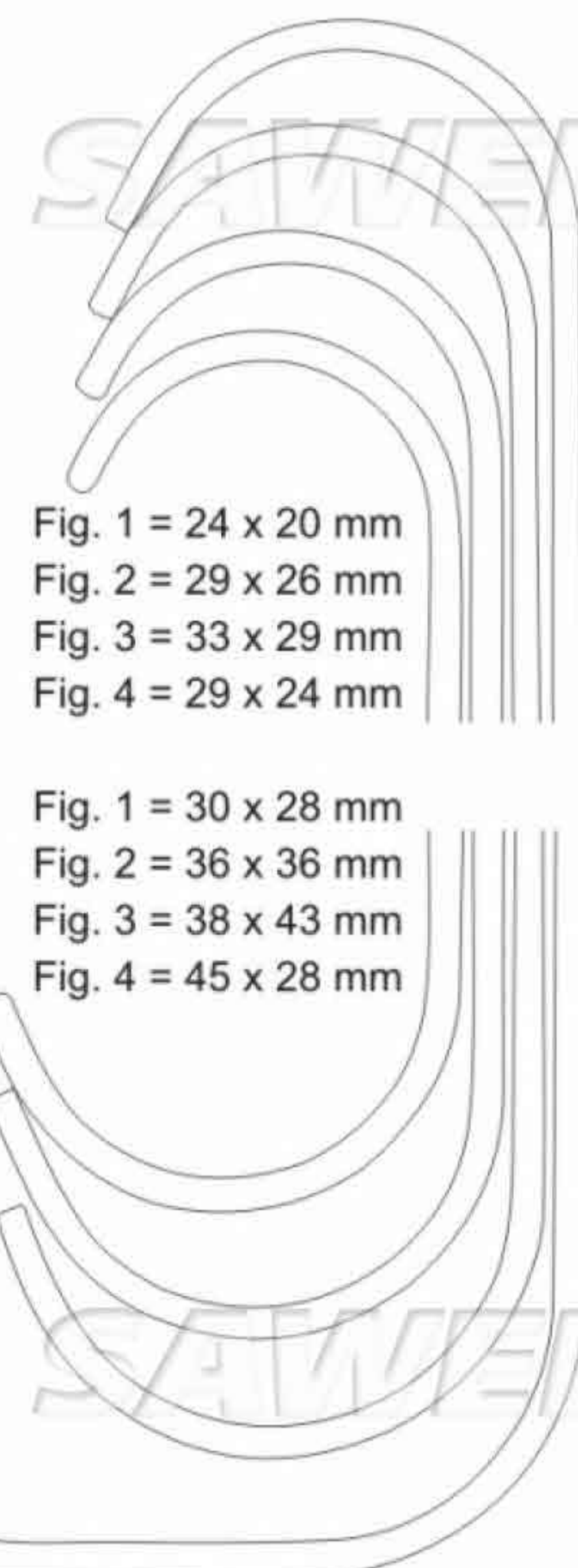
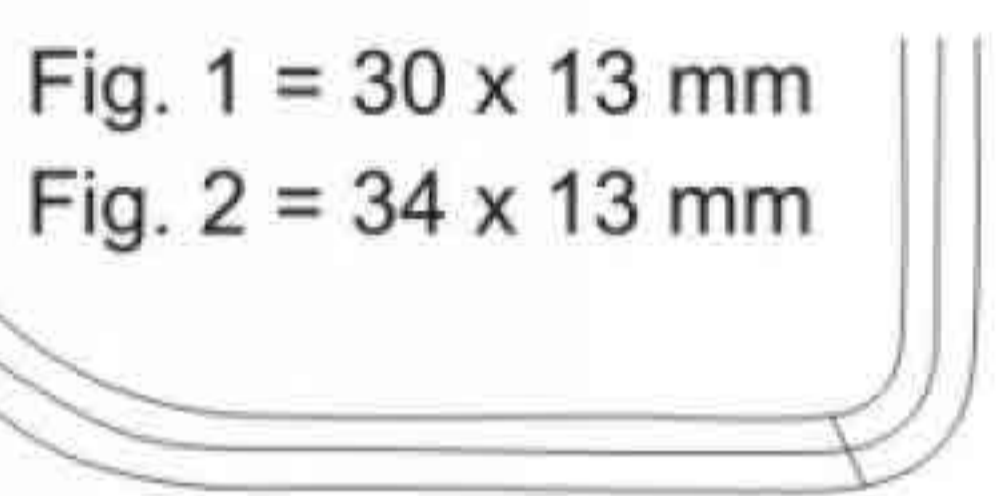
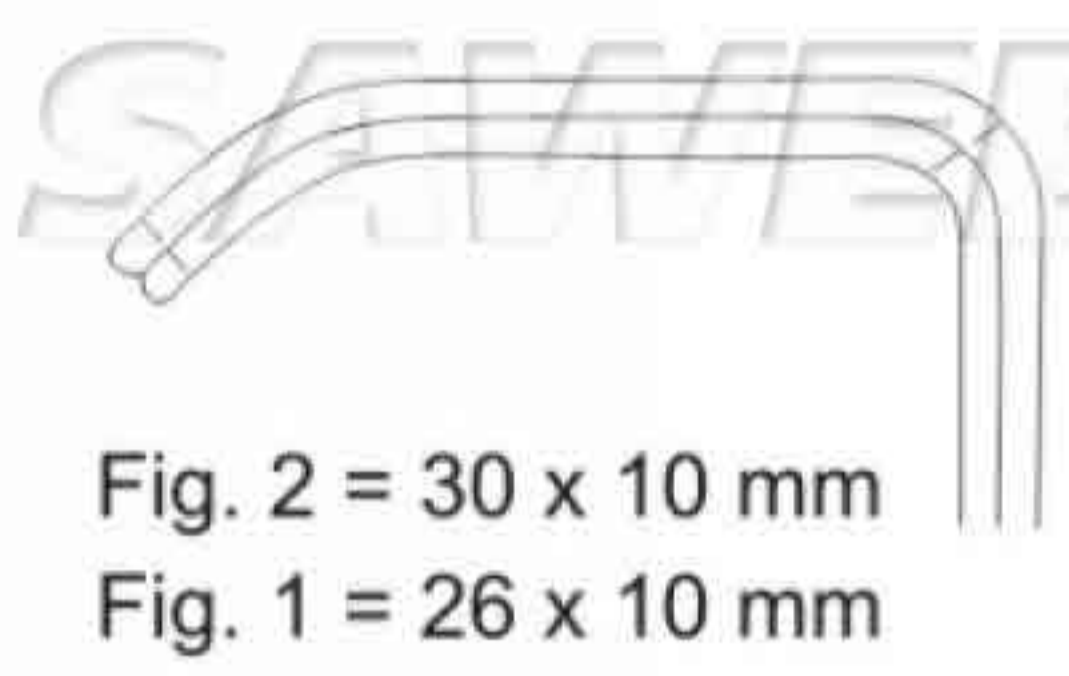
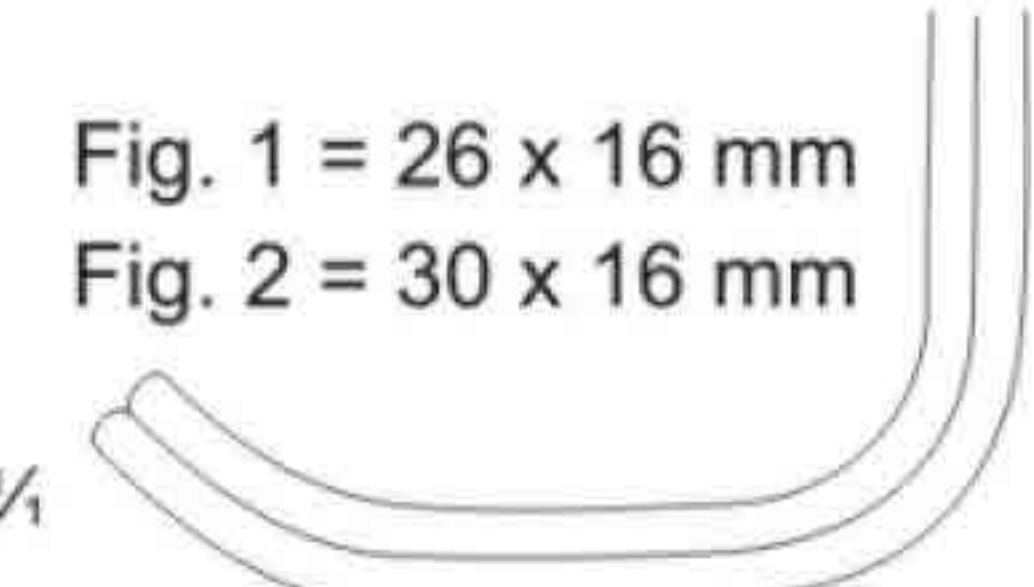
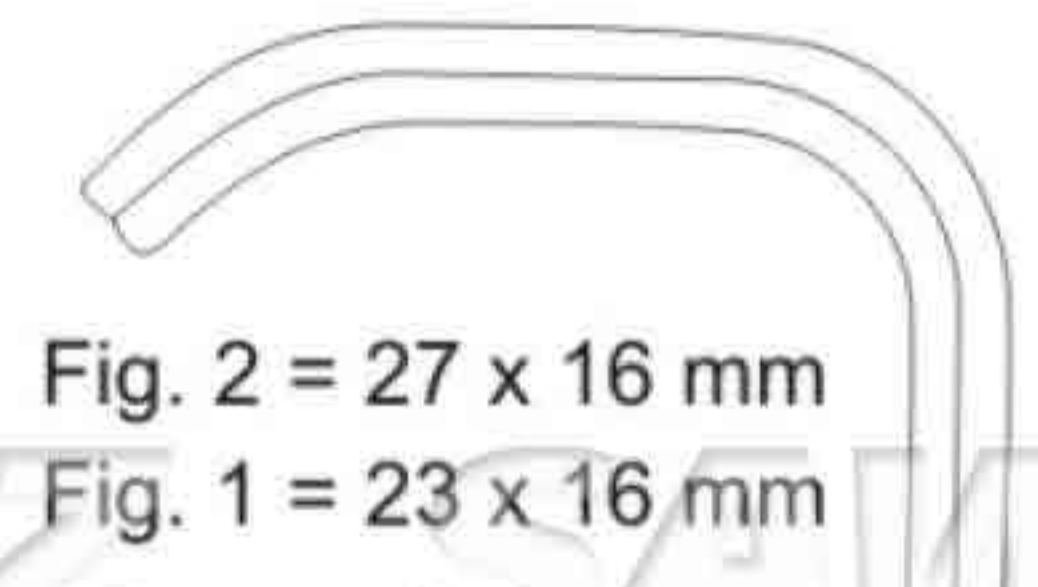


Fig. 1 = 24 x 20 mm
Fig. 2 = 29 x 26 mm
Fig. 3 = 33 x 29 mm
Fig. 4 = 29 x 24 mm

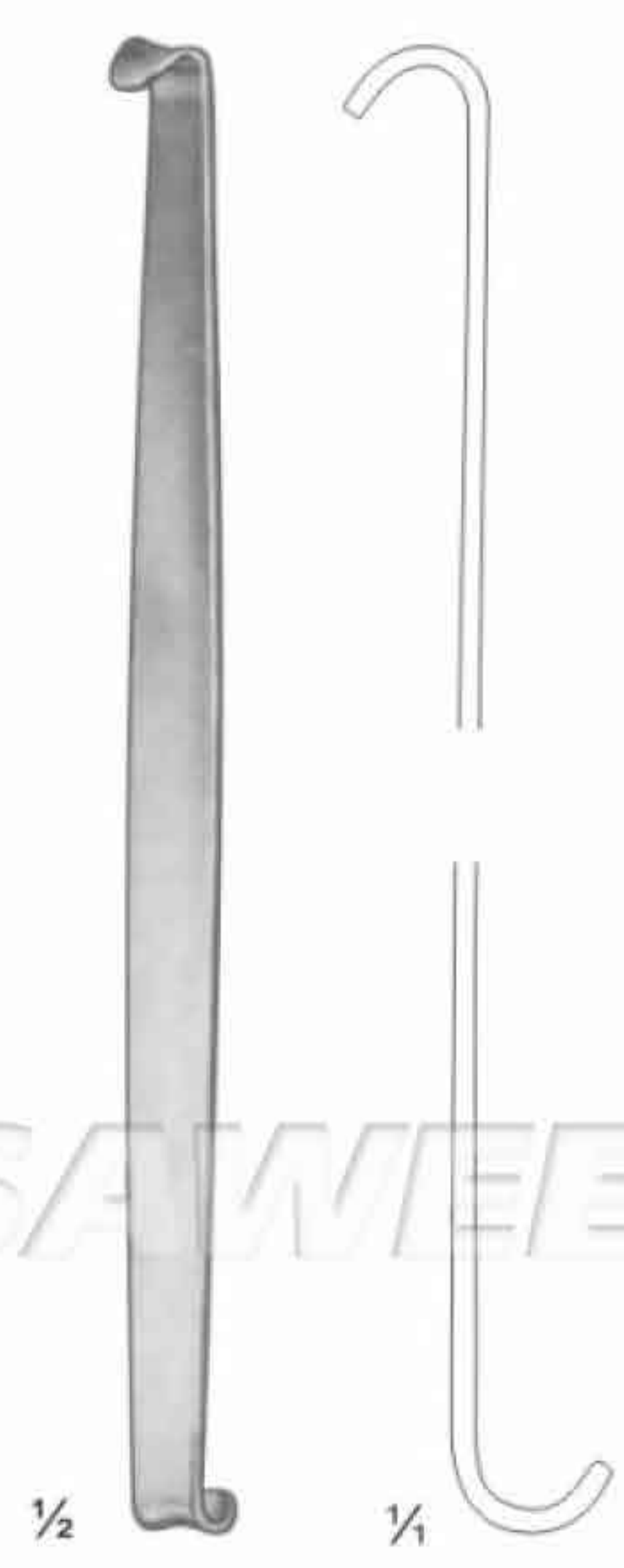
Fig. 1 = 30 x 28 mm
Fig. 2 = 36 x 36 mm
Fig. 3 = 38 x 43 mm
Fig. 4 = 45 x 28 mm



Farabeuf
SSC-11-21-34 - Set of two
12.0 cm / 4¾"



Farabeuf
SSC-11-21-35 - Set of two
15.0 cm / 6"



Mini-Roux
SSC-11-21-36
14.0 cm / 5½"



Baby-Roux
SSC-11-21-37
13.0 cm / 5¼"



Parker
SSC-11-21-38 - Set of two
13.5 cm / 5¼"

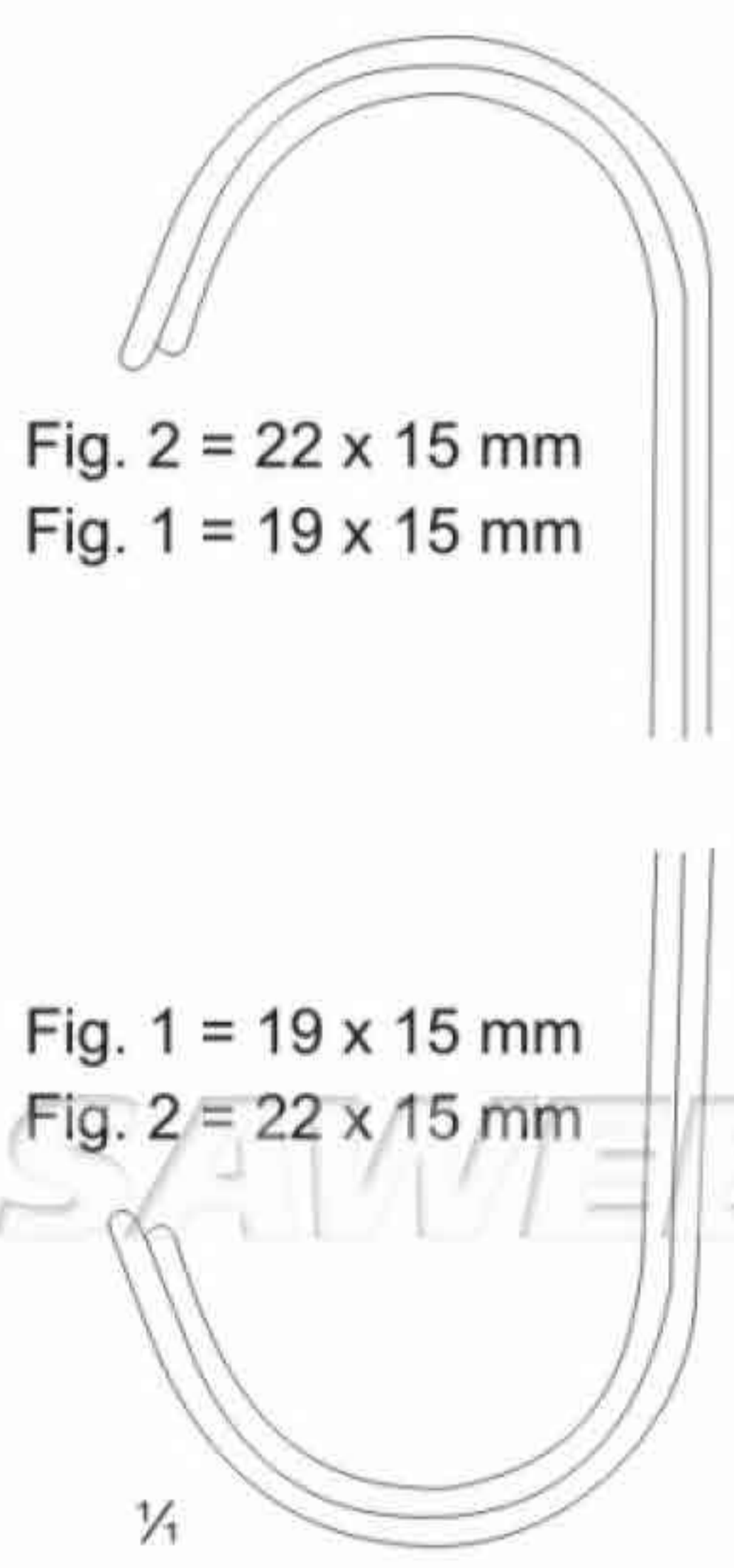


Fig. 1 = 19 x 15 mm
Fig. 2 = 22 x 15 mm



SAWEEZ SAWEEZ SAWEEZ SAWEEZ

Parker
SSC-11-21-39 - Set of two
18.0 cm / 7"

Fig. 1 = 26 x 25 mm
Fig. 2 = 29 x 25 mm

Fig. 2 = 27 x 25 mm
Fig. 1 = 24 x 25 mm

Parker-Mott
SSC-11-21-40 - Set of two
16.0 cm / 6 1/4"

Fig. 2 = 25 x 24 mm
Fig. 1 = 21 x 24 mm

Fig. 1 = 68 x 24 mm
Fig. 2 = 72 x 24 mm

SAWEEZ SAWEEZ SAWEEZ SAWEEZ

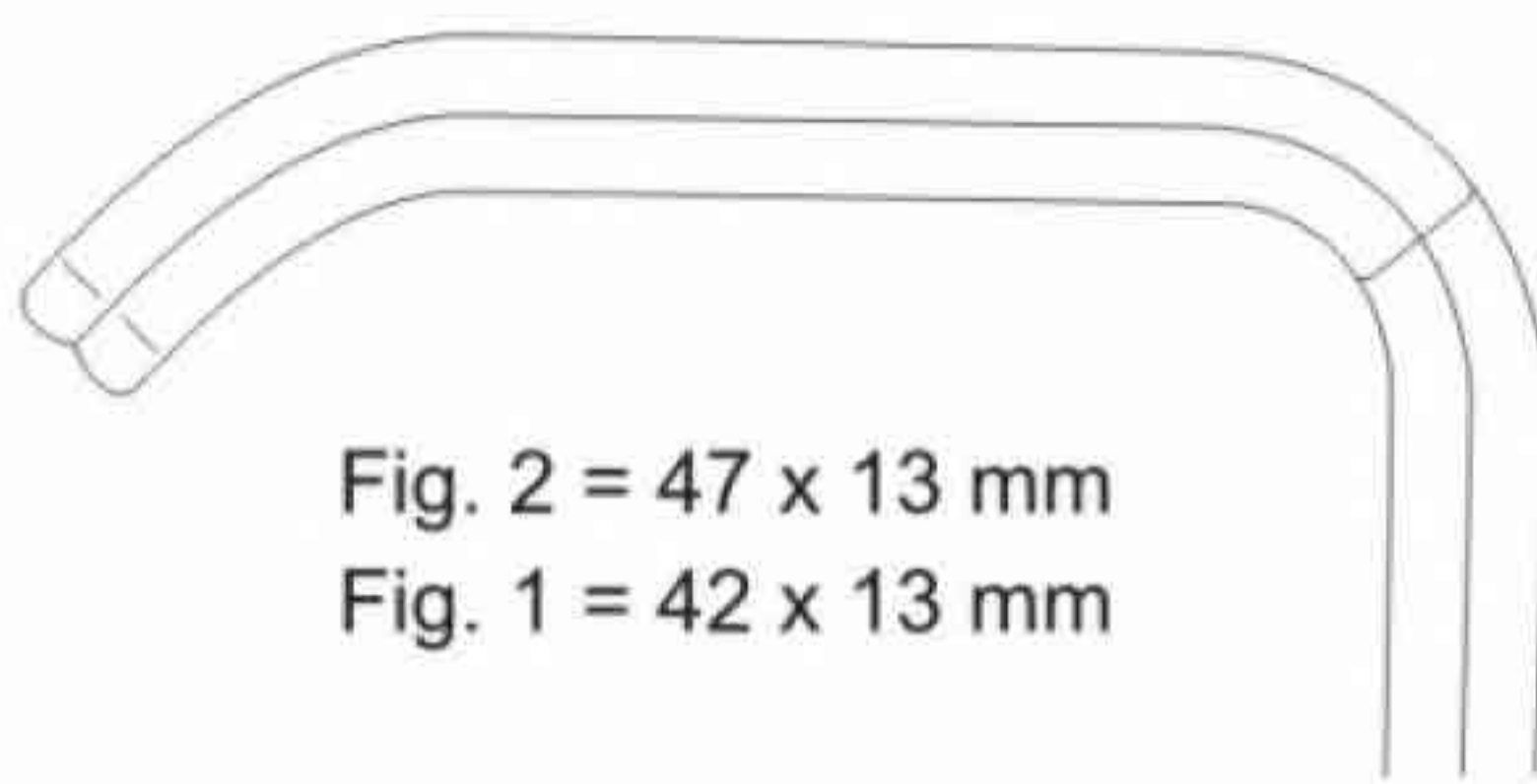


Fig. 2 = 47 x 13 mm
Fig. 1 = 42 x 13 mm

Mathieu
SSC-11-21-41 Set of two
20.0 cm / 8"

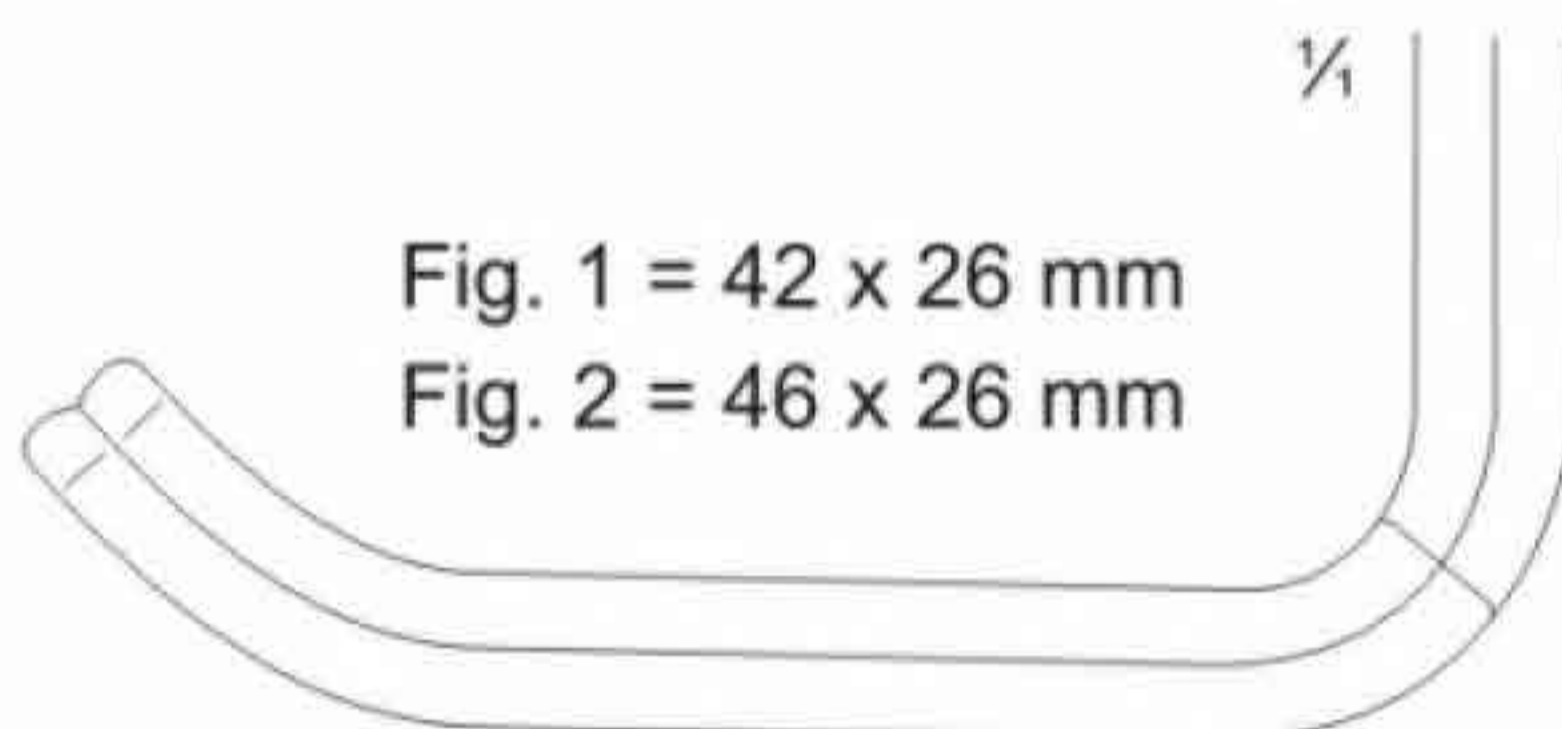


Fig. 1 = 42 x 26 mm
Fig. 2 = 46 x 26 mm

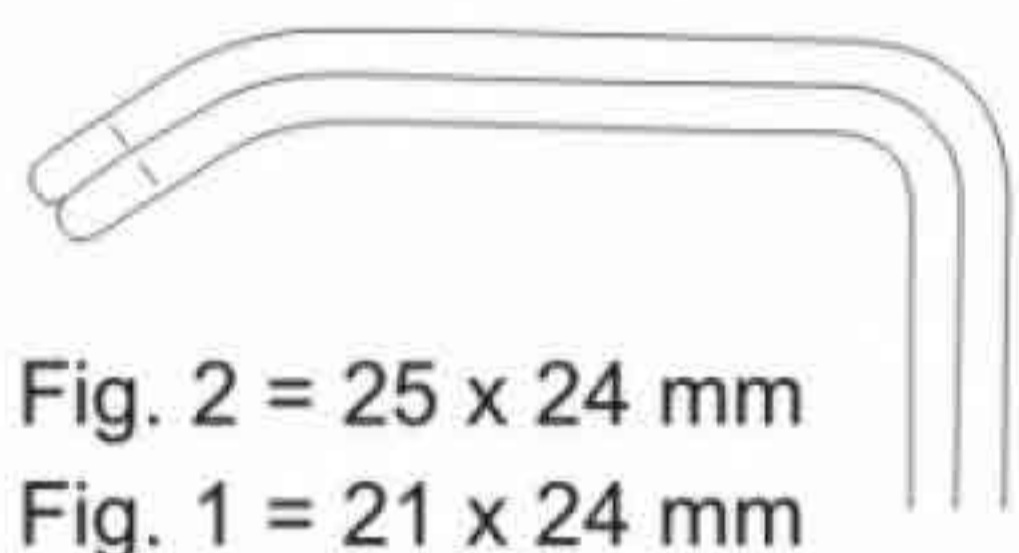


Fig. 2 = 25 x 24 mm
Fig. 1 = 21 x 24 mm

Paeker-Langenbeck
SSC-11-21-42 Set of two
21.0 cm / 8 1/4"

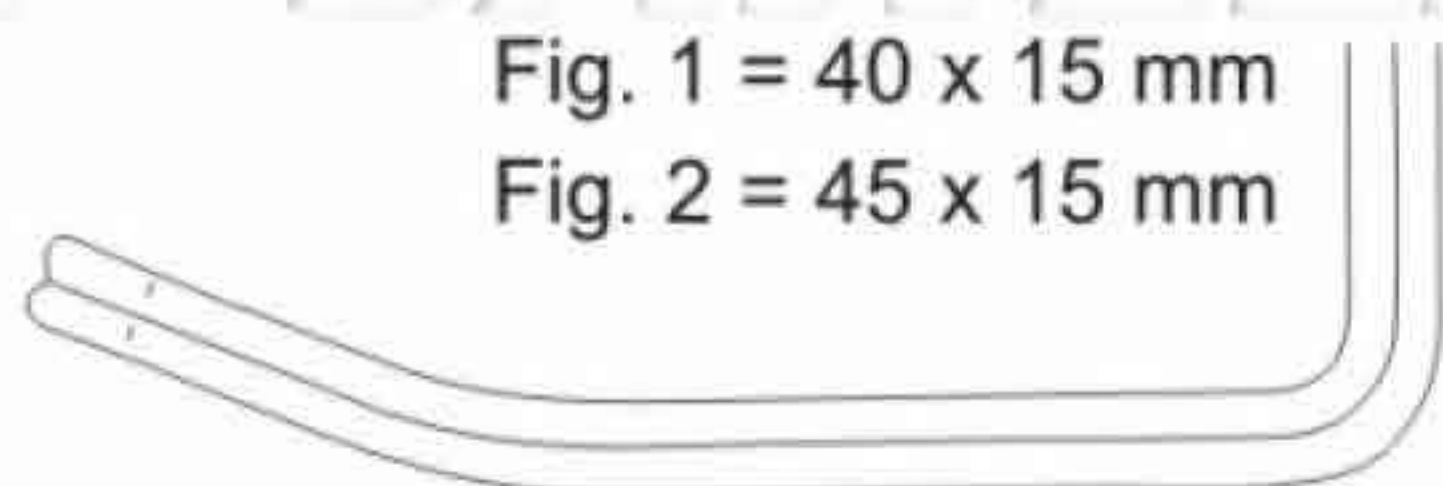
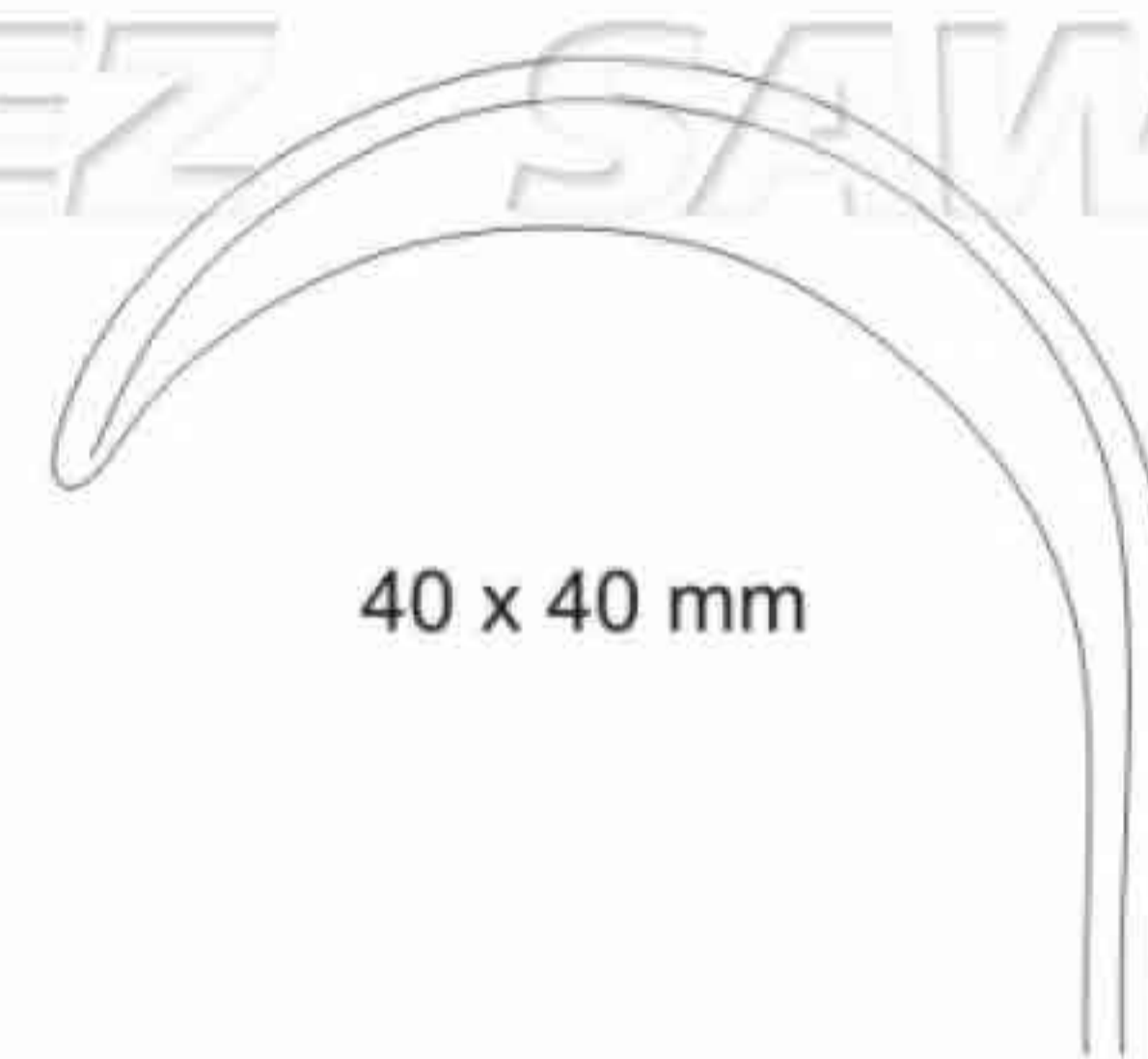


Fig. 1 = 40 x 15 mm
Fig. 2 = 45 x 15 mm



40 x 40 mm

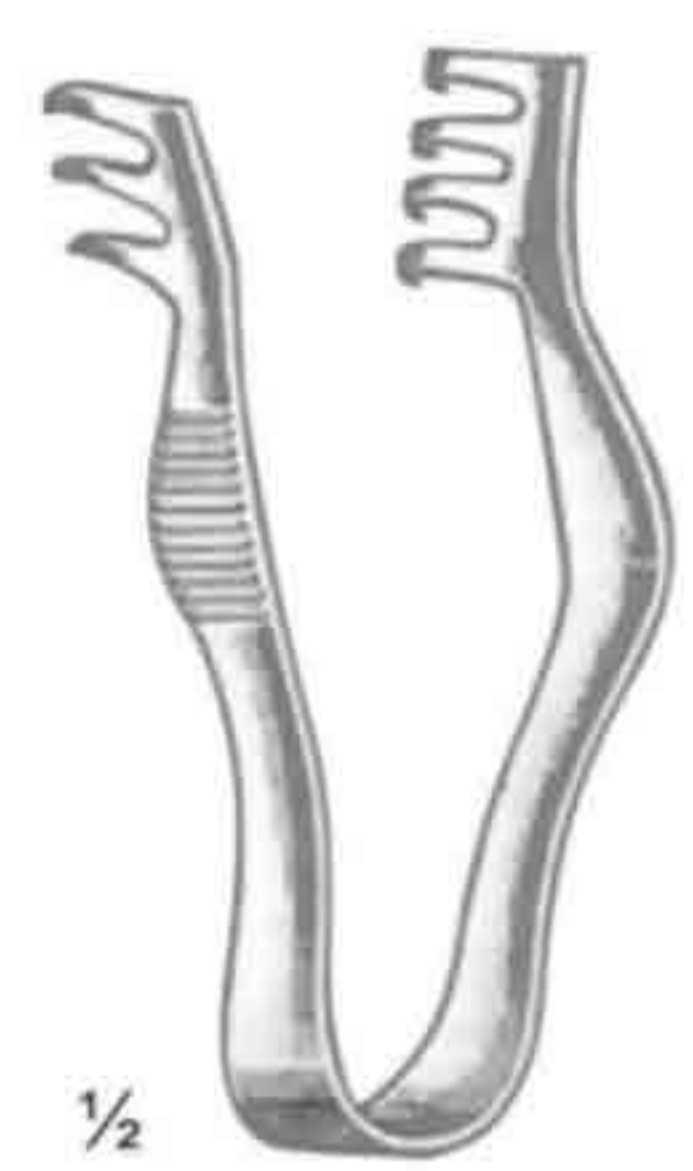
Goelet
SML-11-21-43
19.0 cm / 7 1/2"



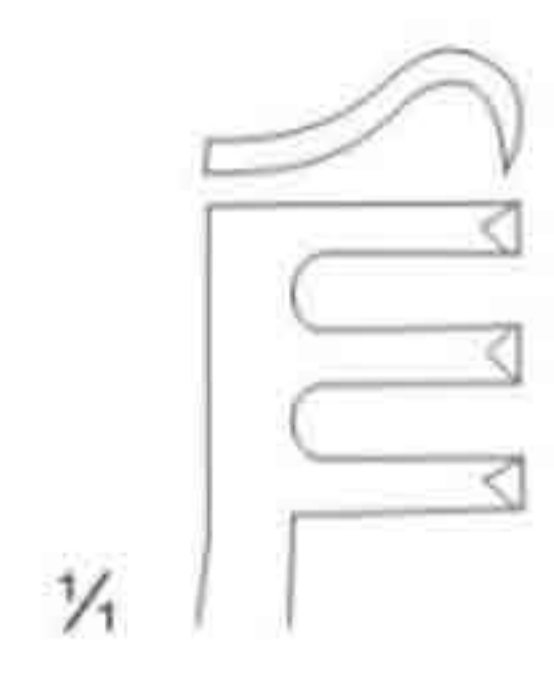
30 x 30 mm



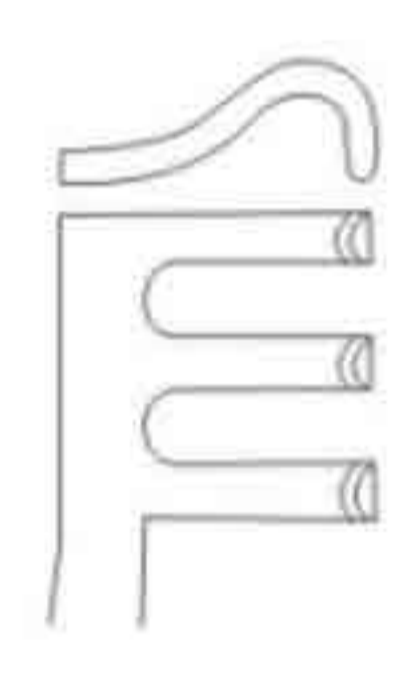
SAWEEZ SAWEEZ SAWEEZ SAWEEZ



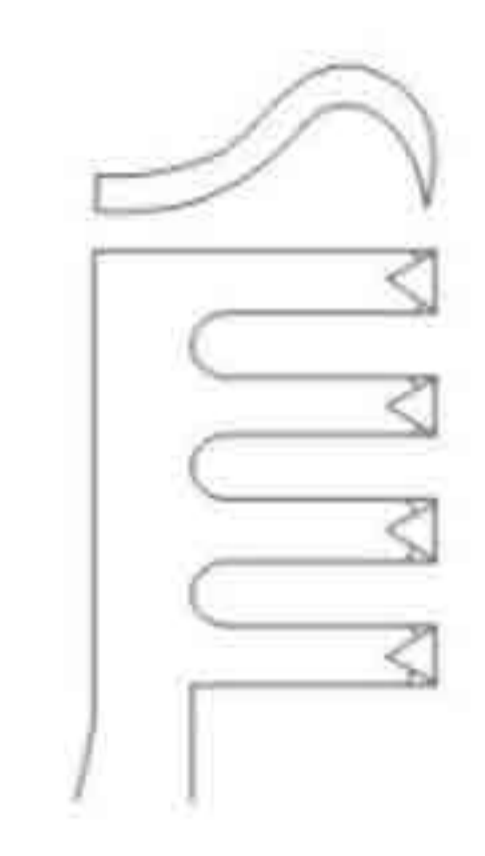
Finsen
5.0 cm / 2"
3 x 4 teeth



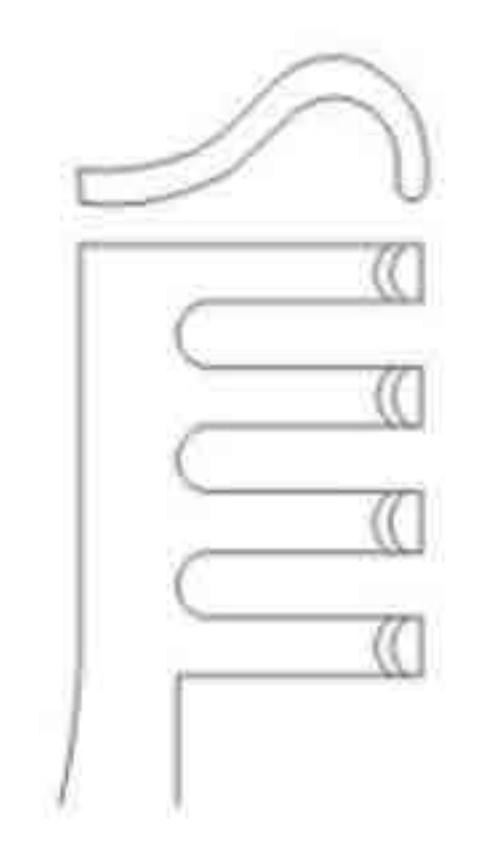
SSC-11-21-44
sharp



SSC-11-21-45
blunt



SSC-11-21-46
sharp

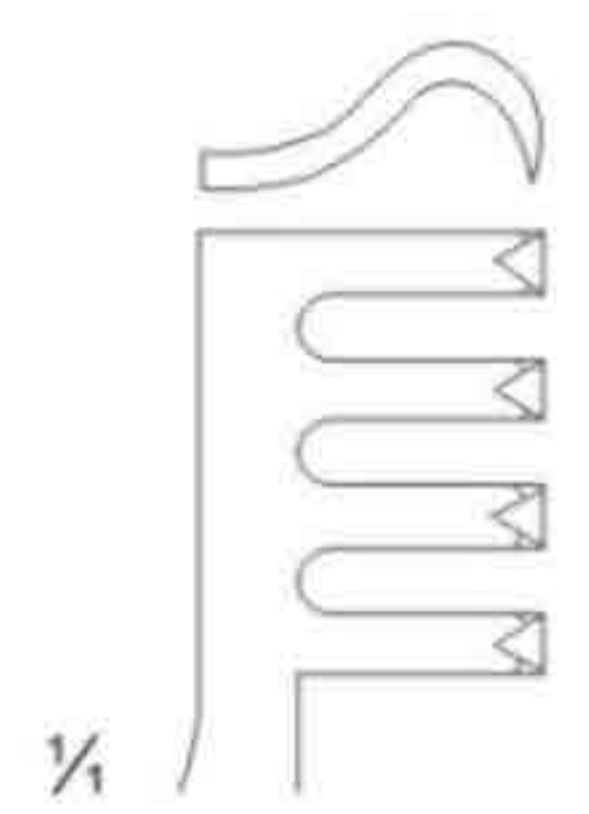


SSC-11-21-47
blunt

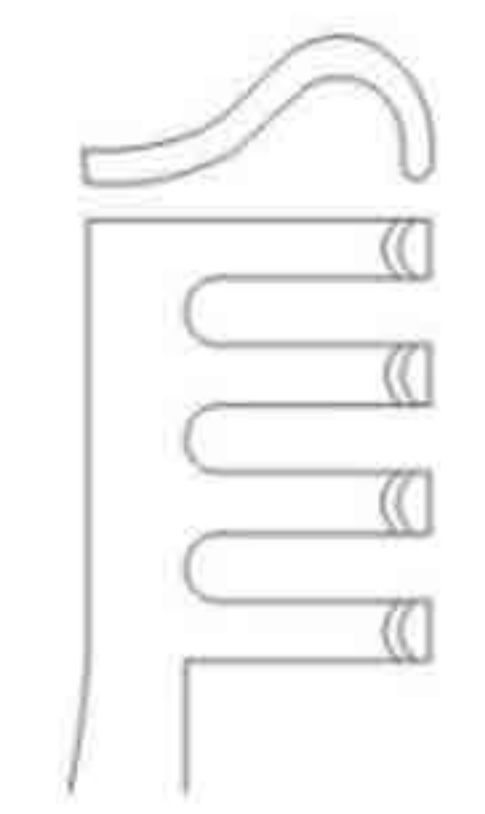
SAWEEZ SAWEEZ SAWEEZ SAWEEZ



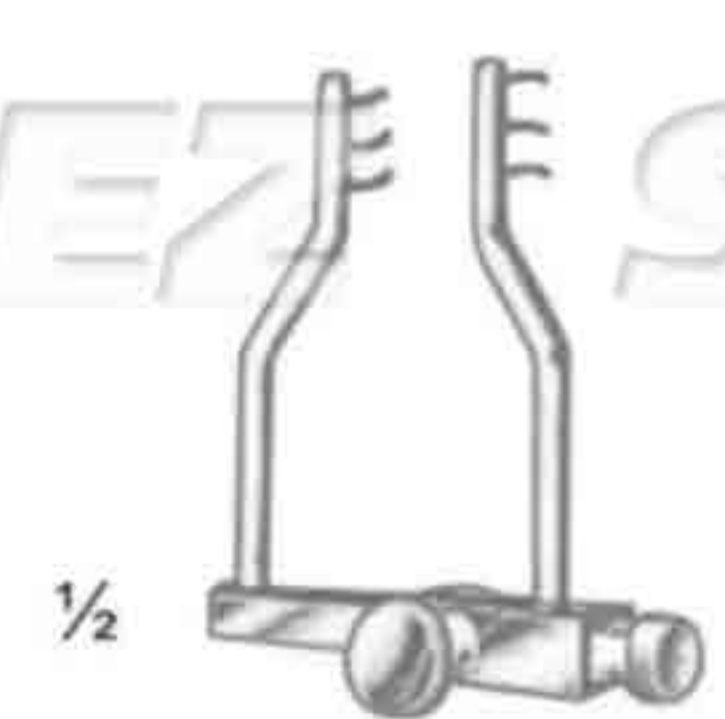
Special Model
7.0 cm / 2¾"
3 x 4 teeth



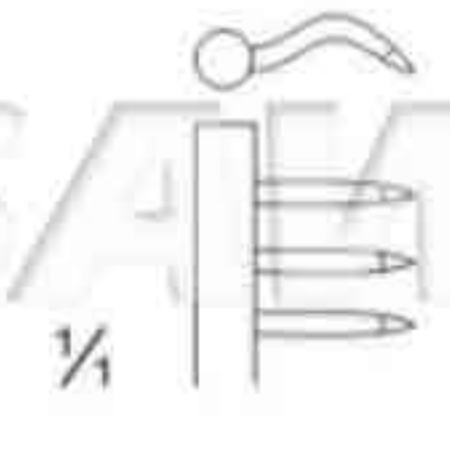
SSC-11-21-48
sharp



SSC-11-21-49
blunt

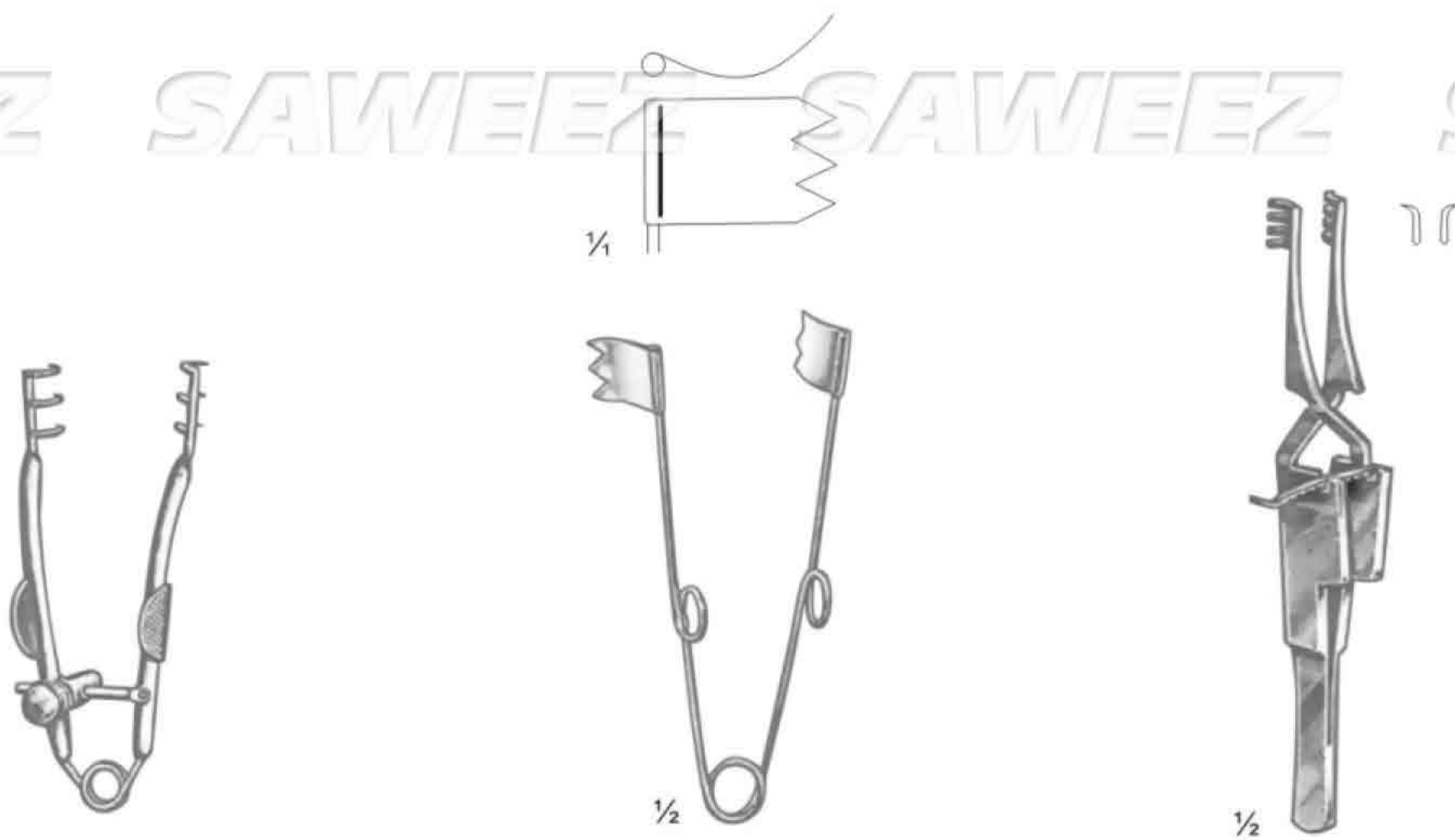


Logan
SSC-11-21-50
4.0 cm / 1½"
3 x 3 teeth





SAWEEZ SAWEEZ SAWEEZ SAWEEZ



SSC-11-21-51
8.0 cm / 3 1/4"
3 x 3 teeth

SSC-11-21-52
10.0 cm / 4"
4 x 4 teeth
blunt

SAWEEZ SAWEEZ SAWEEZ SAWEEZ



SSC-11-21-53
7.0 cm / 2 3/4"
sharp

SSC-11-21-54
10.0 cm / 4"
sharp

SSC-11-21-55
7.0 cm / 2 3/4"
blunt

SSC-11-21-56
10.0 cm / 4"
semi sharp

SSC-11-21-57
10.0 cm / 4"
blunt

SAWEEZ SAWEEZ SAWEEZ SAWEEZ



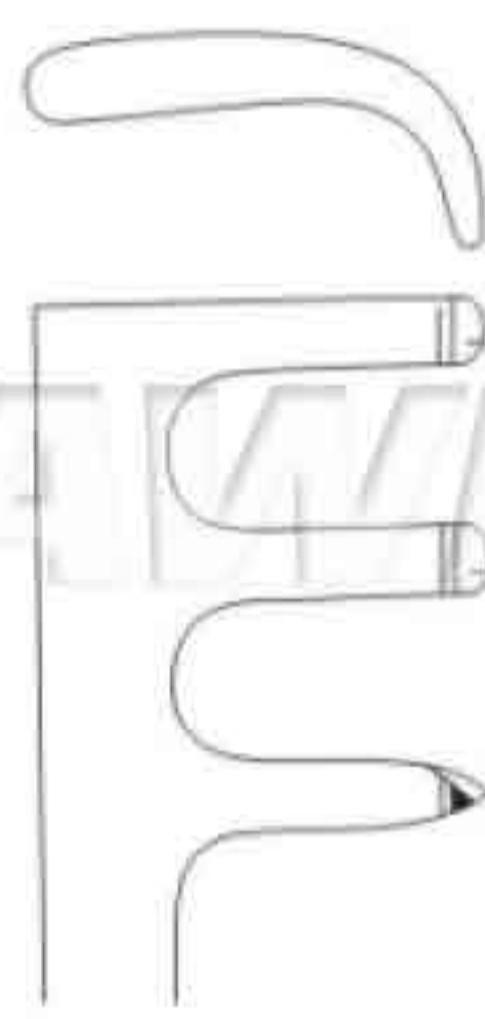
1/2

Jansen
10.0 cm / 4"
3 x 3 teeth

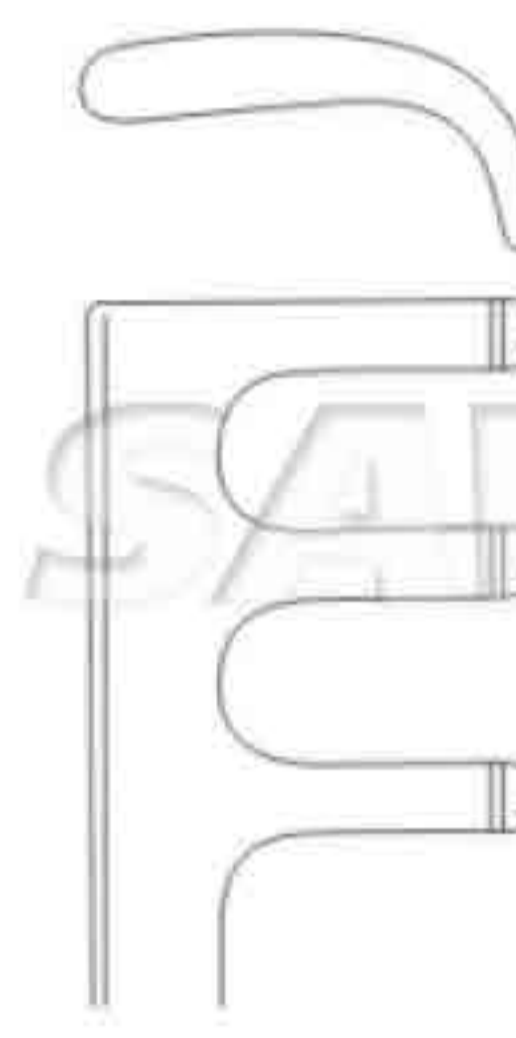


1/4

SSC-11-21-58
sharp

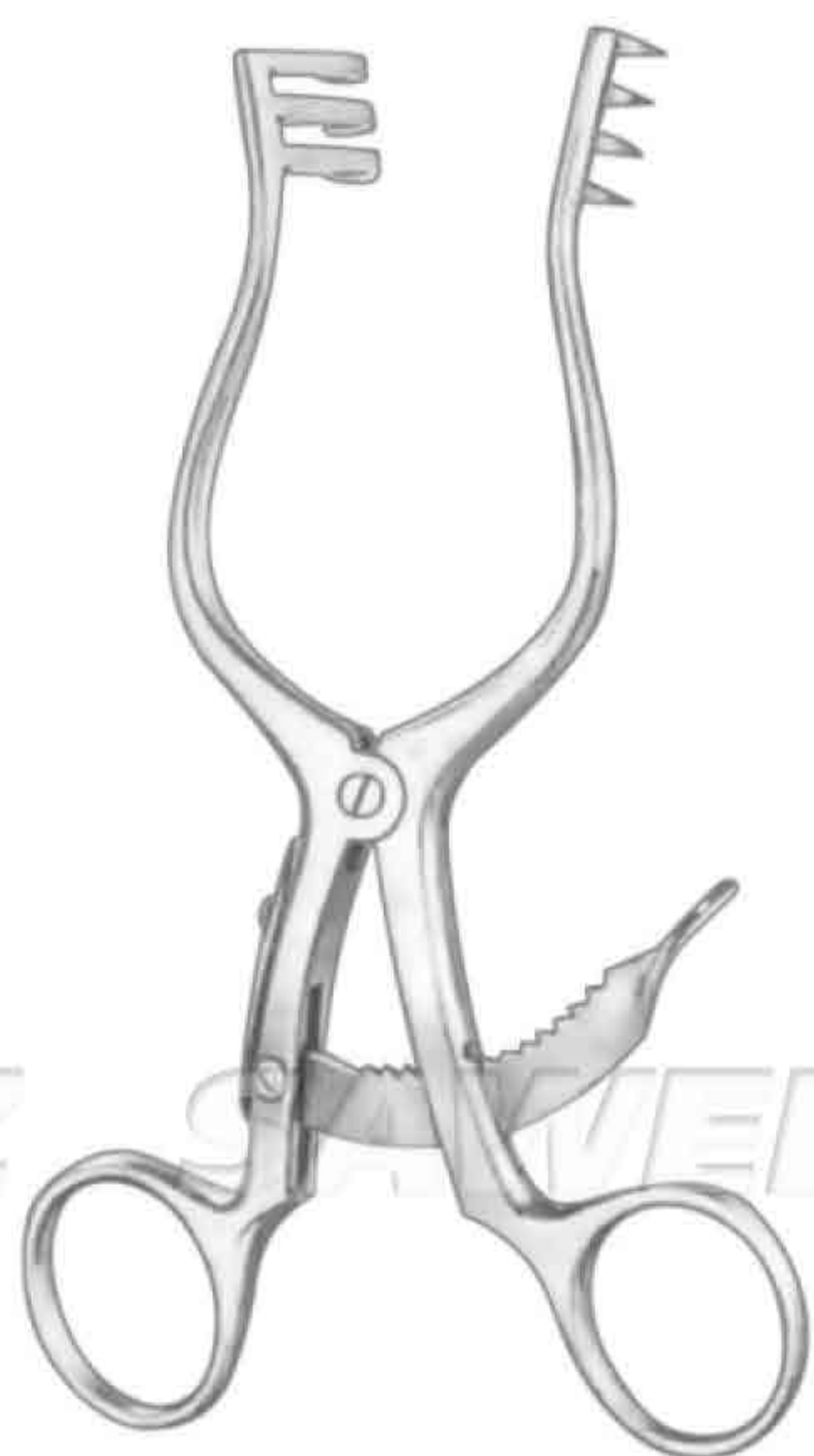


SSC-11-21-59
with 1 sharp and
2 blunt prongs each



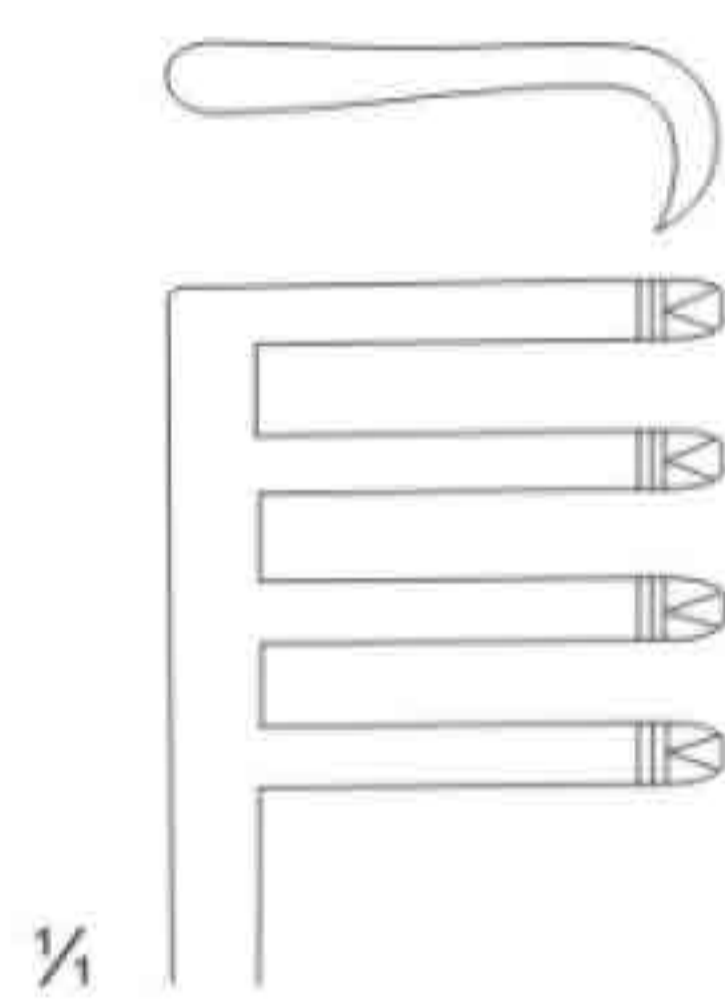
SSC-11-21-60
blunt

SAWEEZ SAWEEZ SAWEEZ SAWEEZ



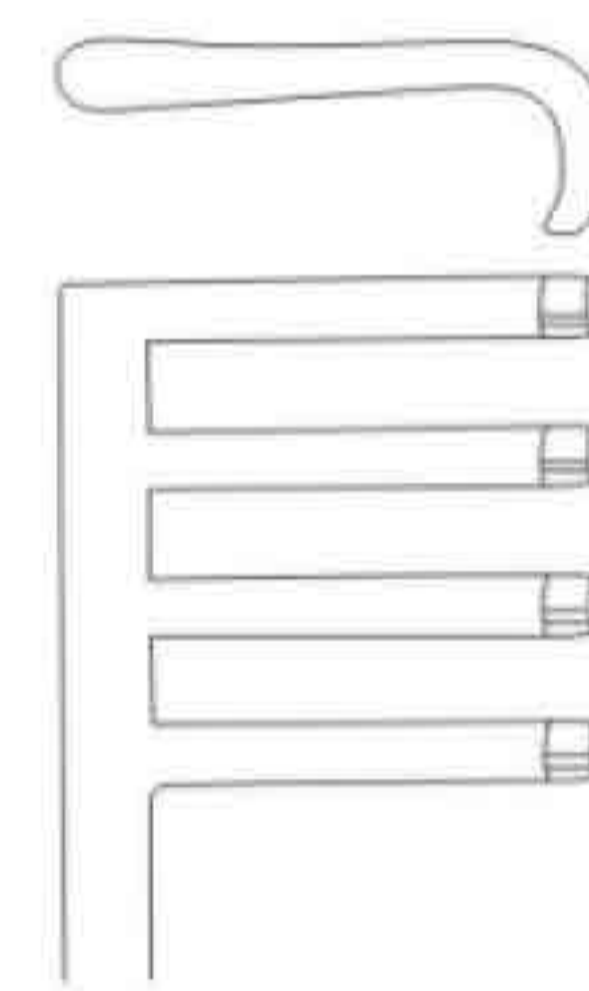
1/2

Scalp Contour
14.0 cm / 5 1/2"
3 x 4 teeth



1/4

SSC-11-21-61
sharp

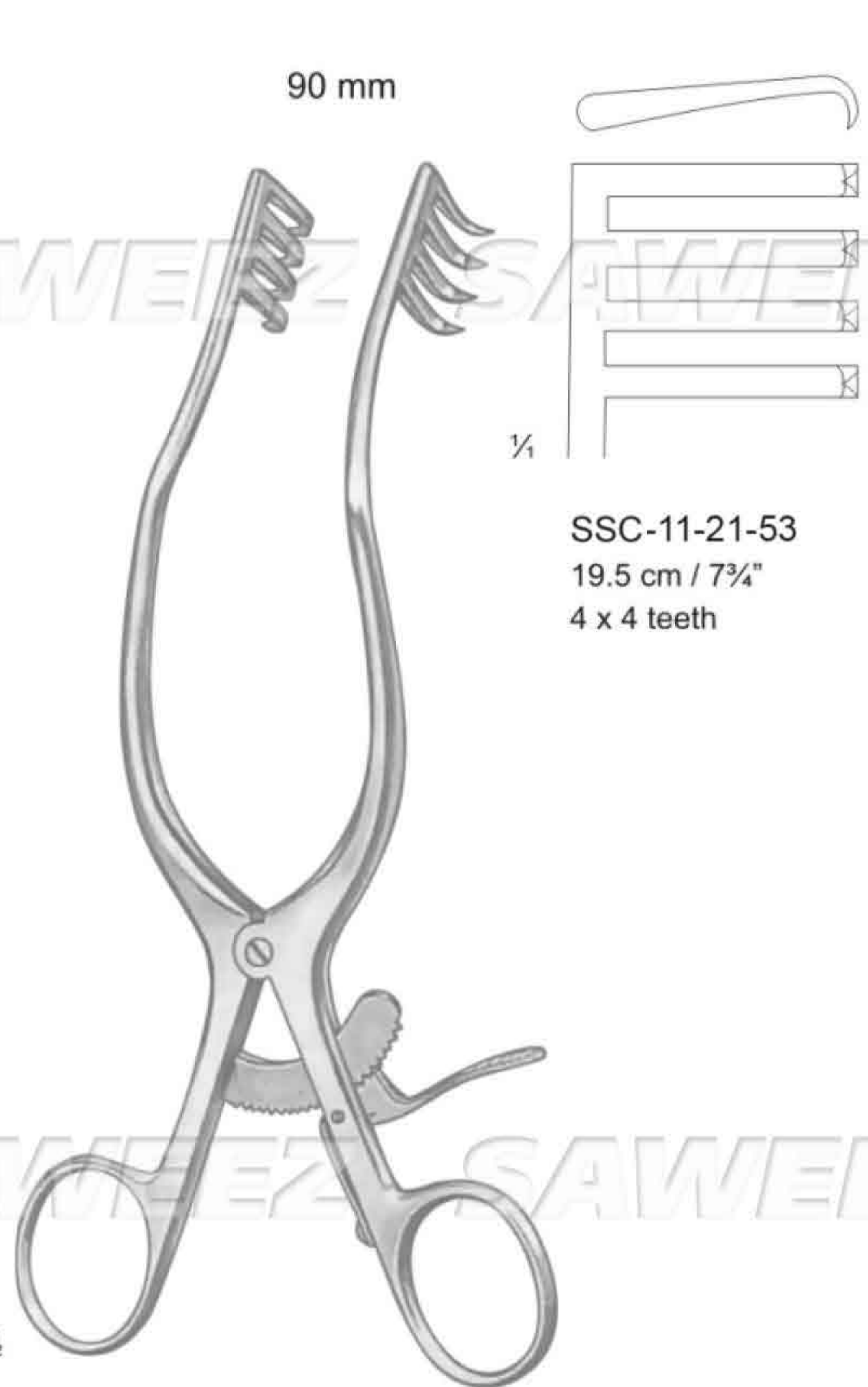


SSC-11-21-52
blunt

SAWEEZ SAWEEZ SAWEEZ SAWEEZ



SAWEEZ SAWEEZ SAWEEZ SAWEEZ

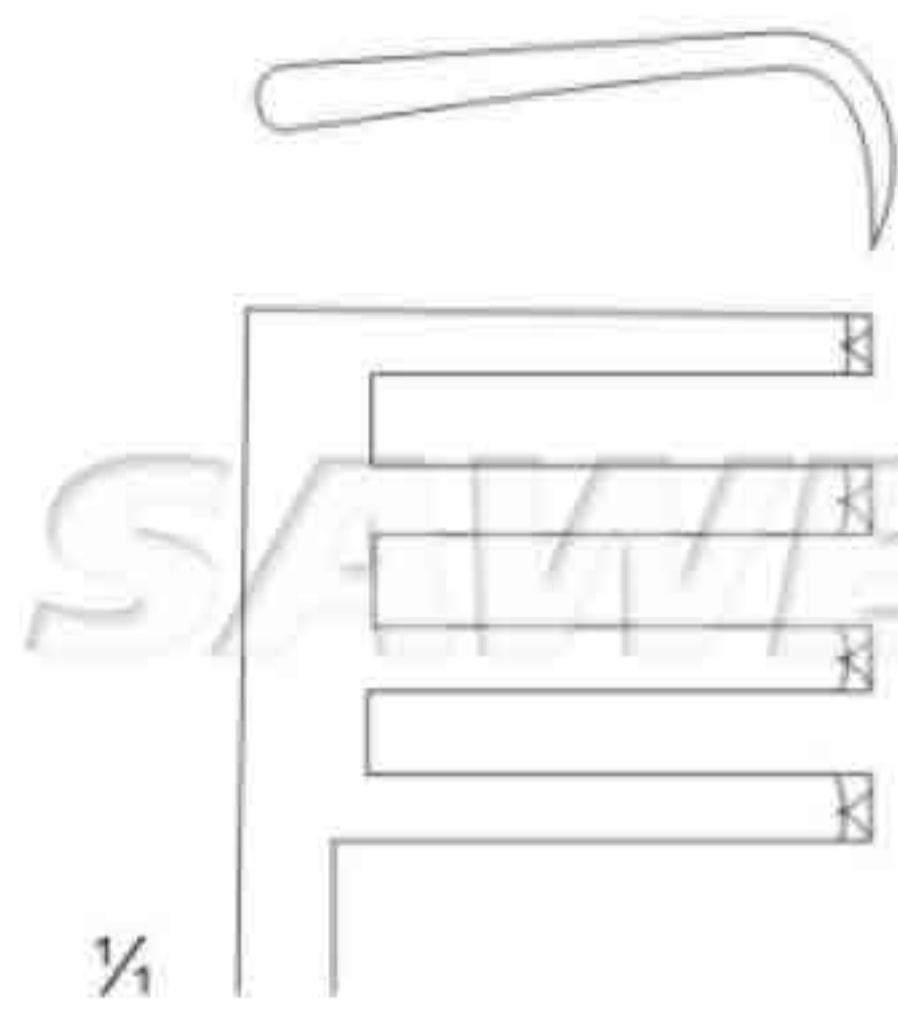


SSC-11-21-53
19.5 cm / 7 3/4"
4 x 4 teeth

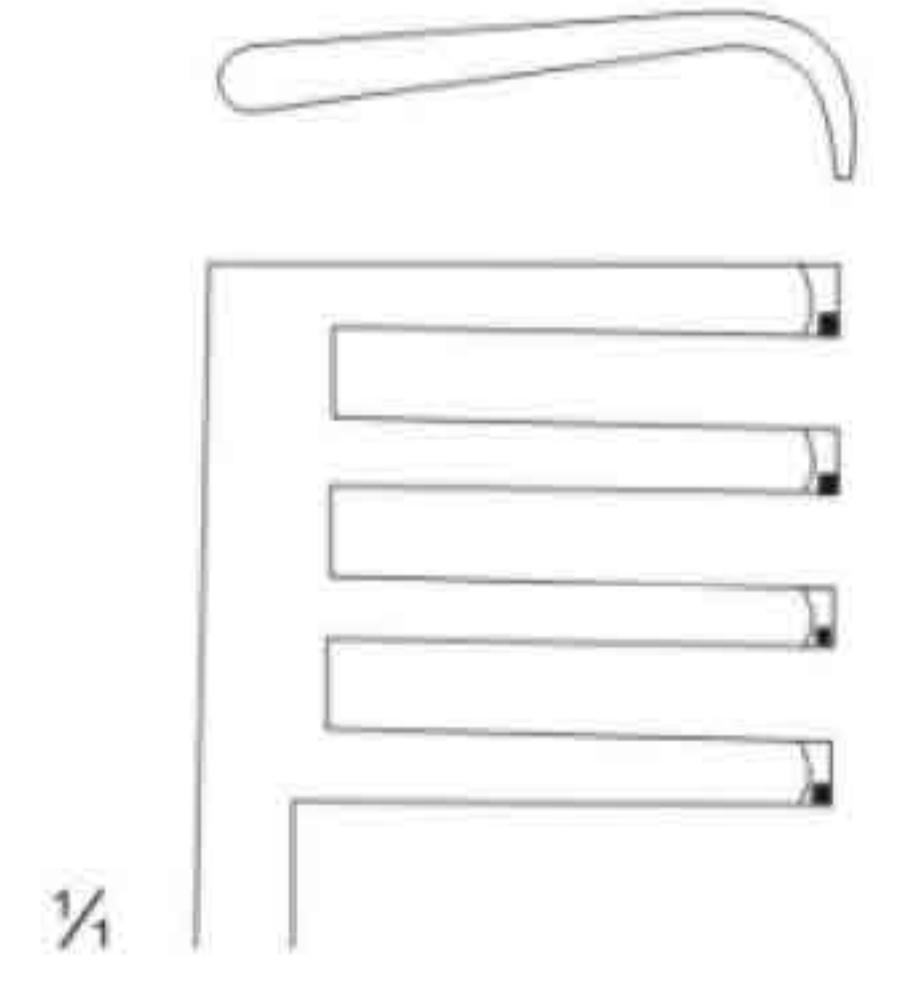
Anderson-Adson



Weitlaner
20.0 cm / 8"



SSC-11-21-54
sharp



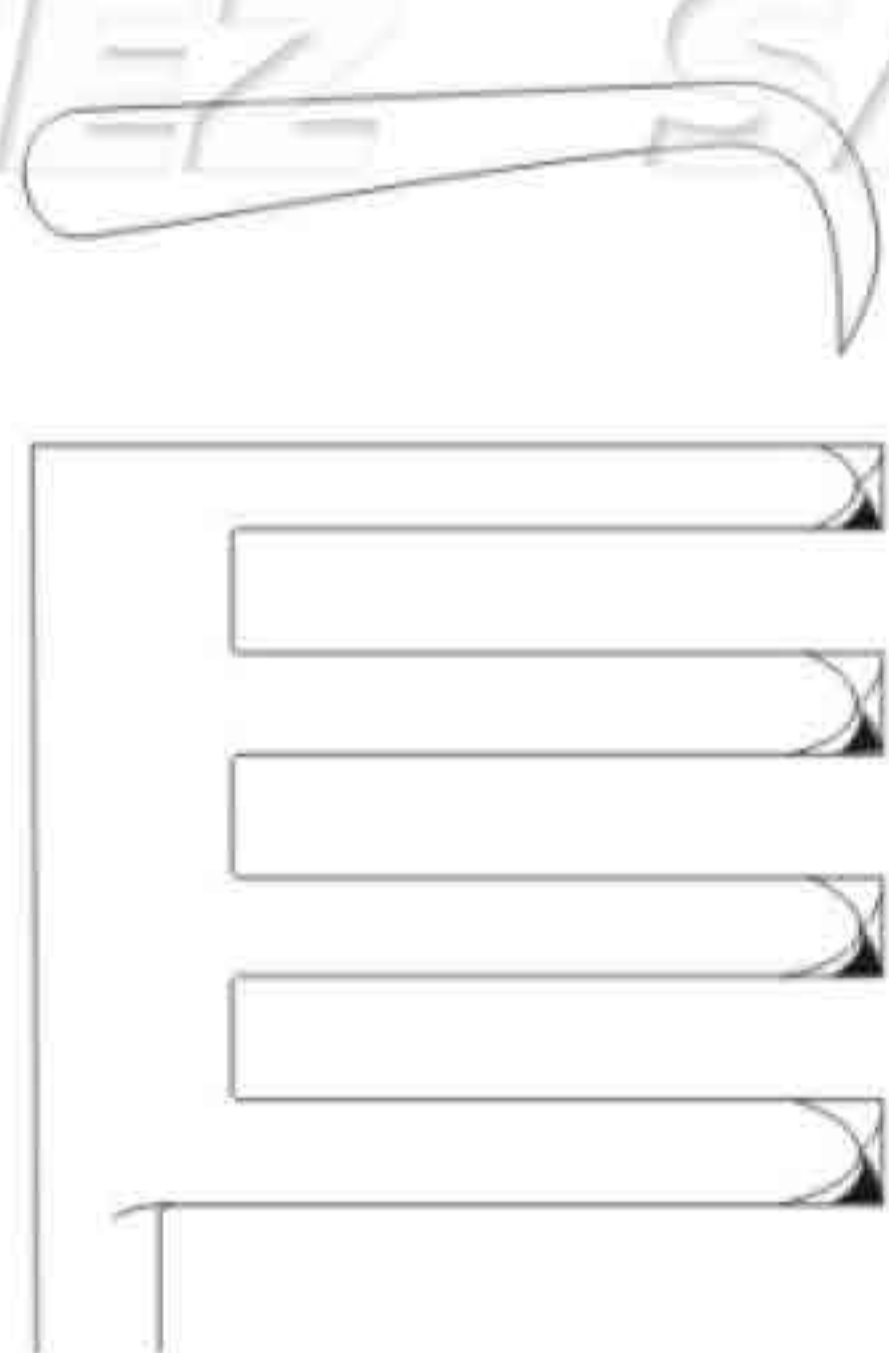
SSC-11-21-55
blunt



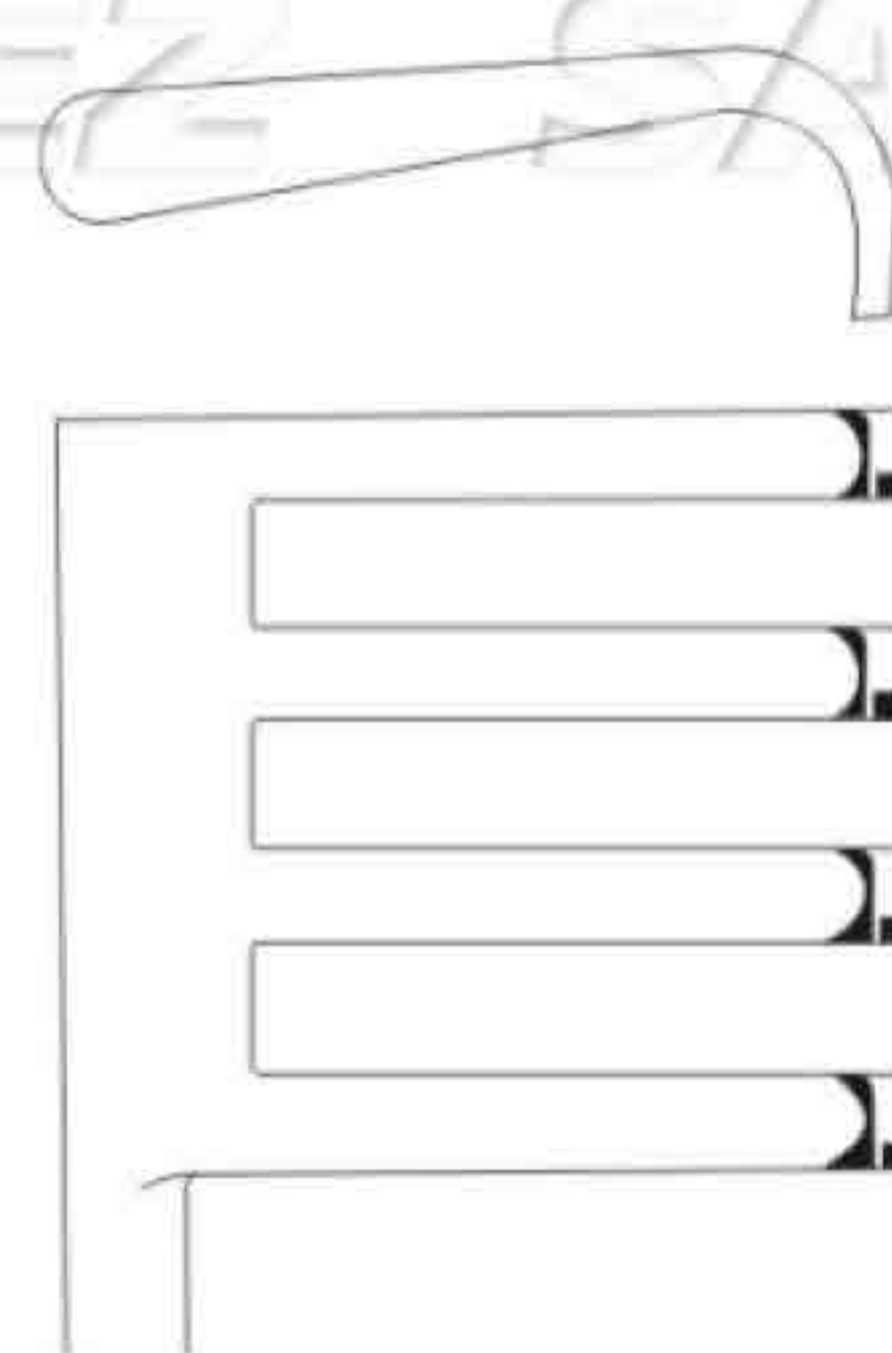
SAWEEZ SAWEEZ SAWEEZ SAWEEZ



Adson
26.5 cm / 10 1/2"

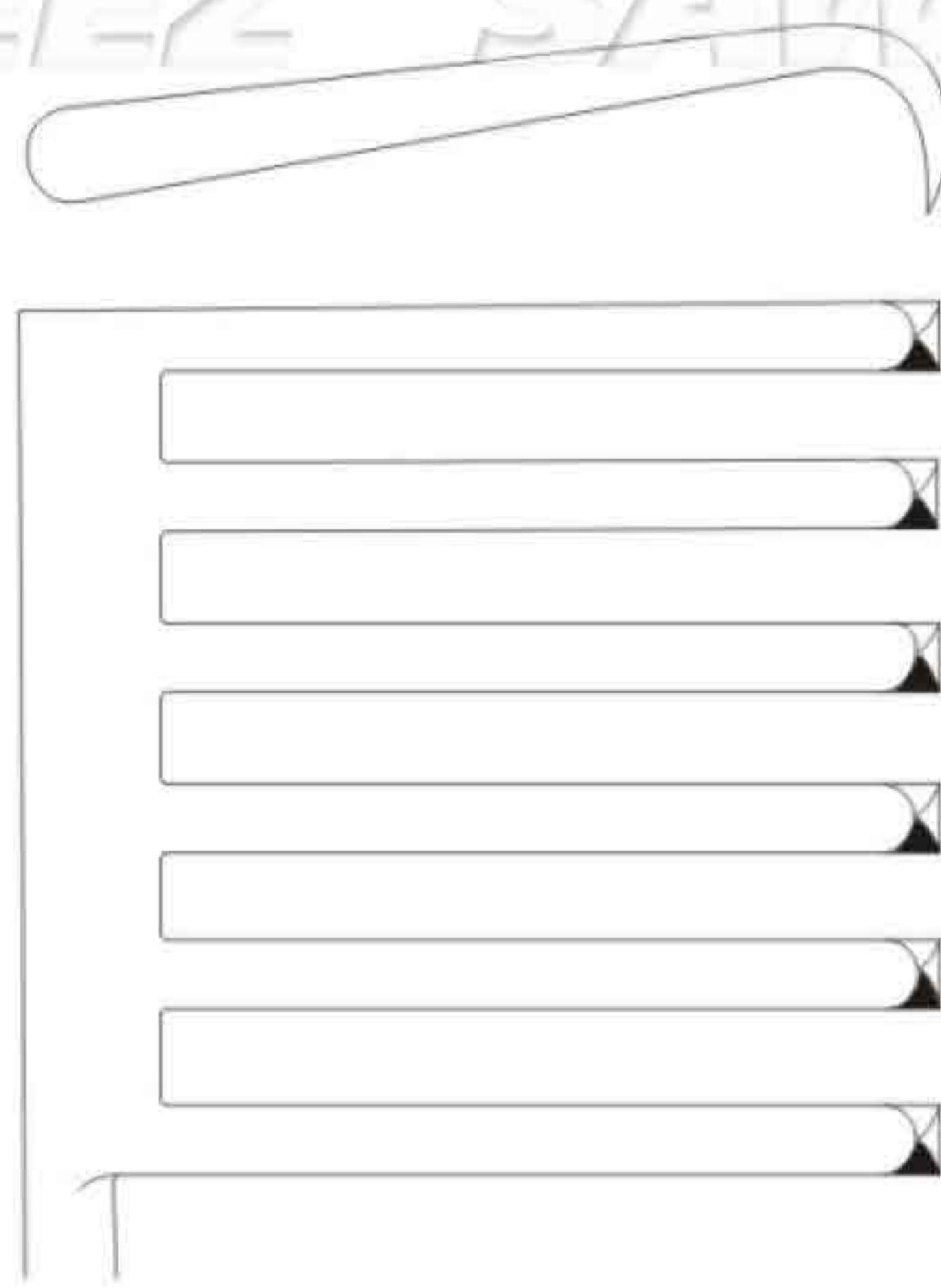


SSC-11-21-56
3 x 4 teeth
sharp

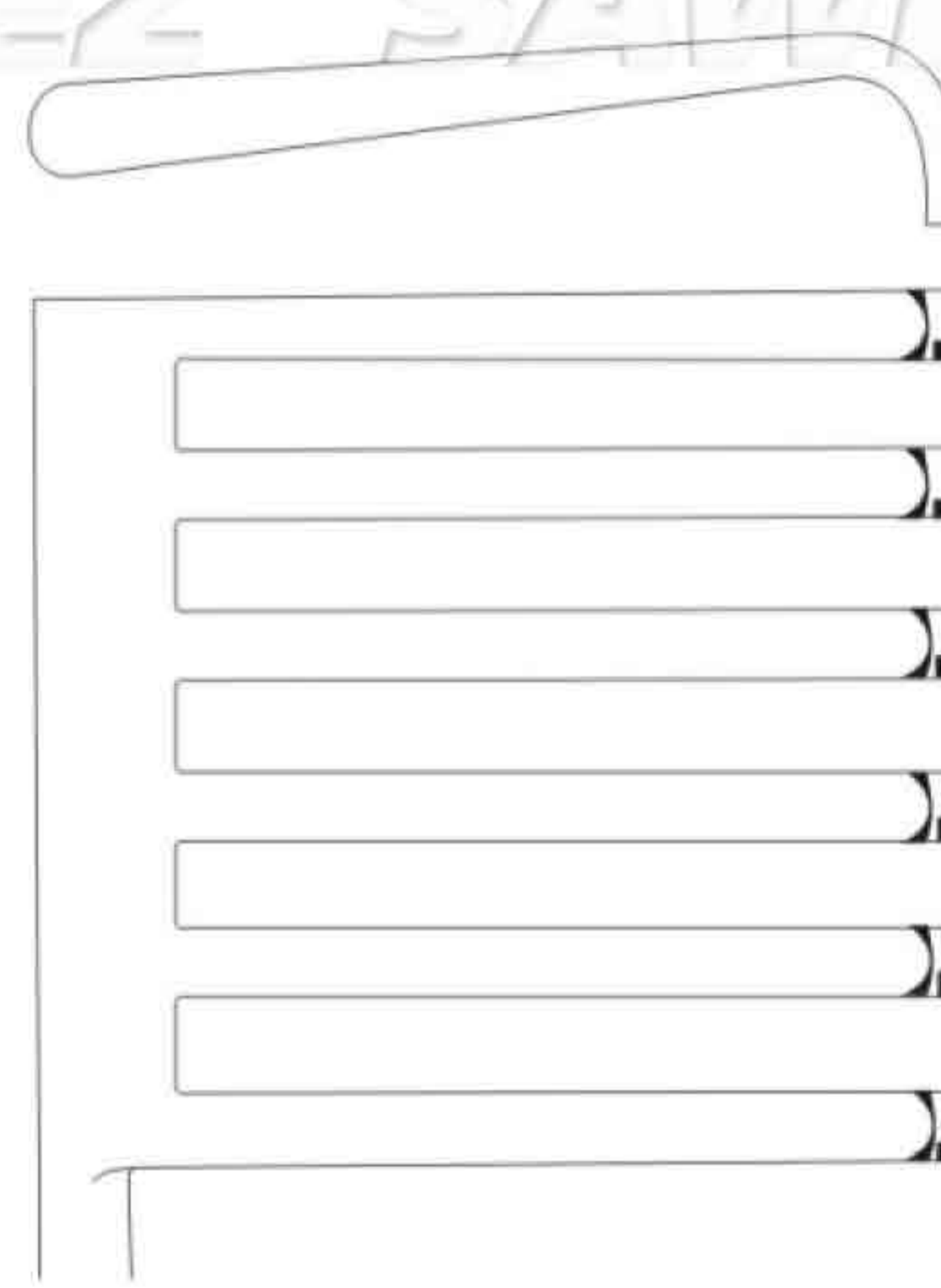


SSC-11-21-57
3 x 4 teeth
blunt

SAWEEZ SAWEEZ SAWEEZ SAWEEZ

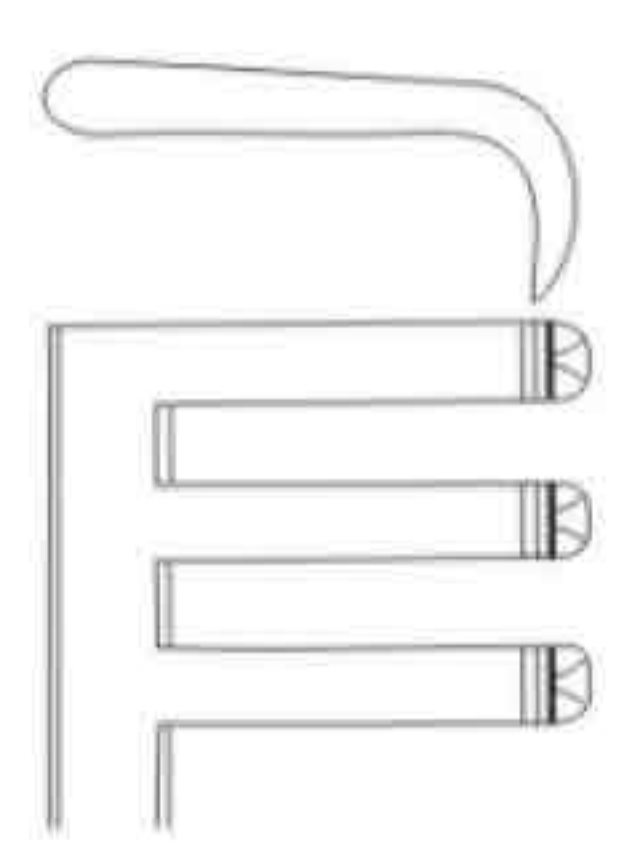


SSC-11-21-58
6 x 6 teeth
sharp

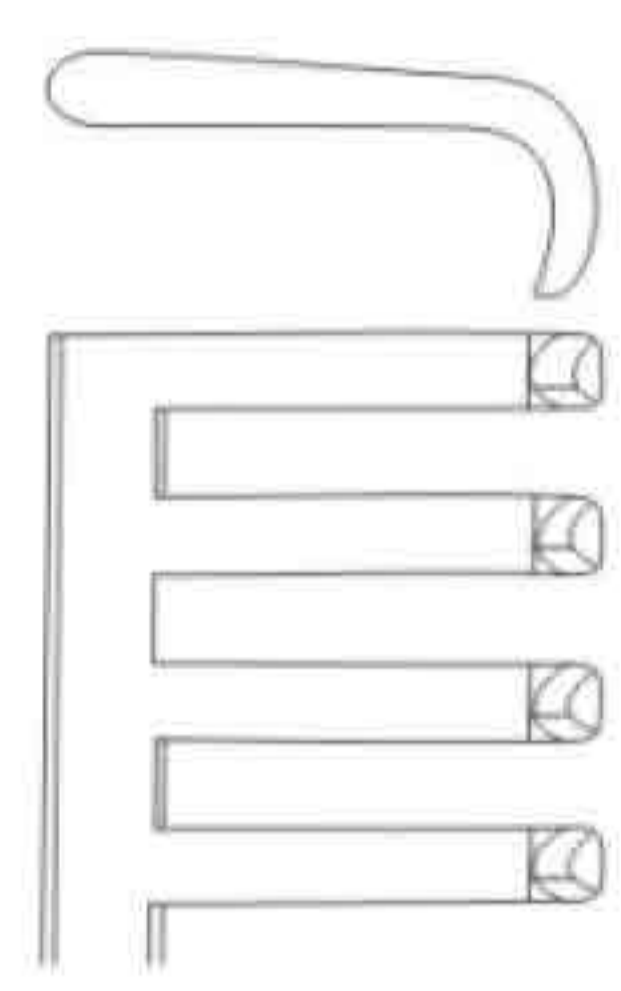


SSC-11-21-59
6 x 6 teeth
blunt

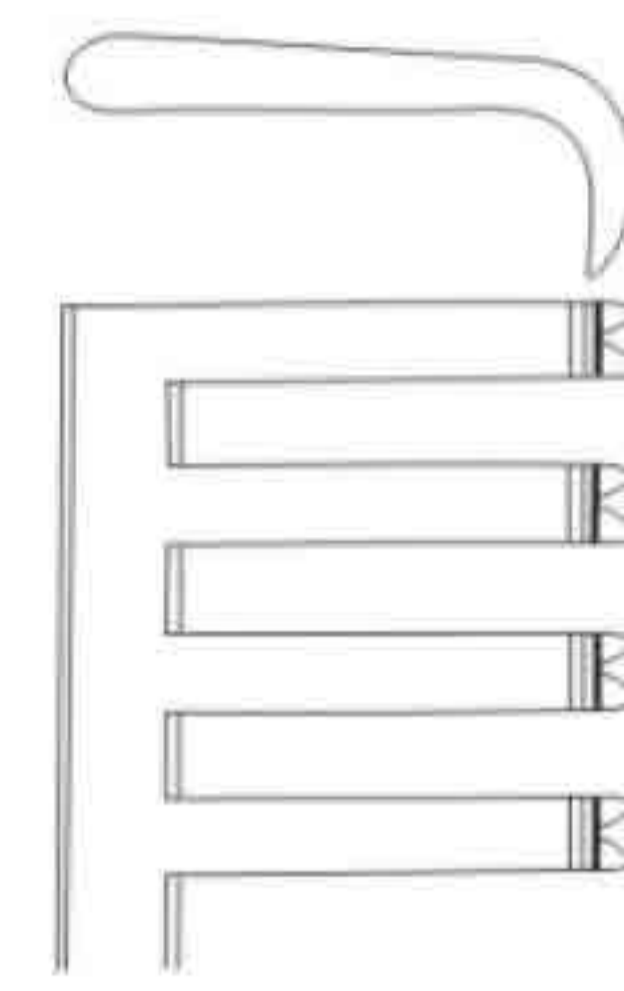
SAWEEZ SAWEEZ SAWEEZ SAWEEZ



SSC-11-21-60
10.5 cm / 6 1/4"
2 x 3 teeth
sharp

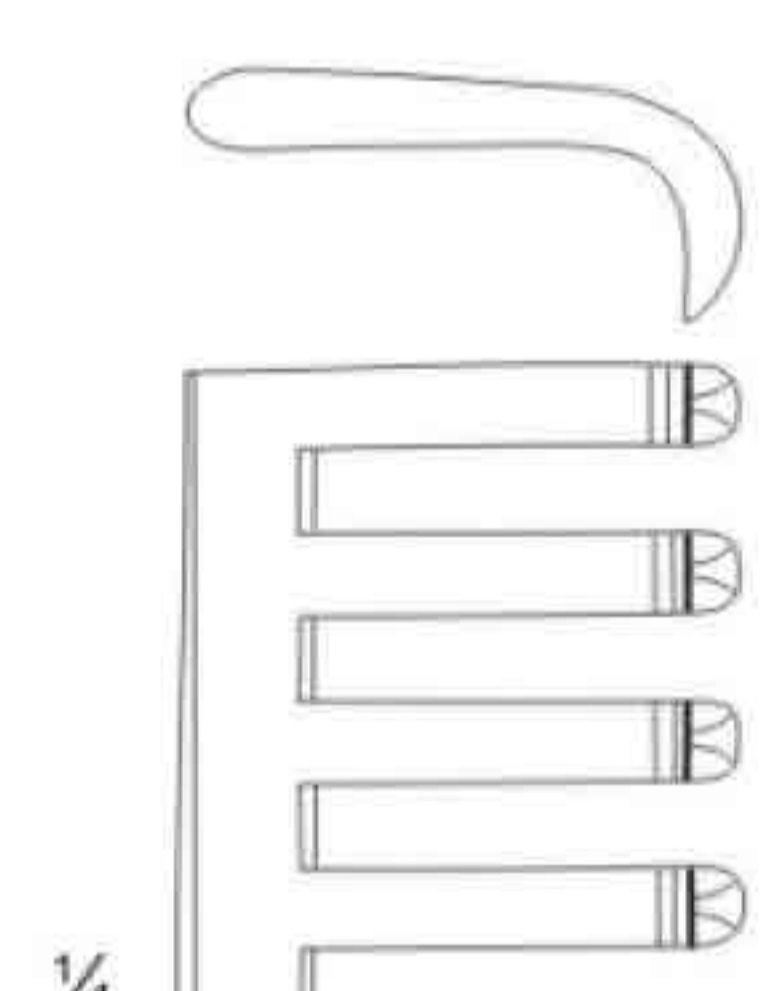
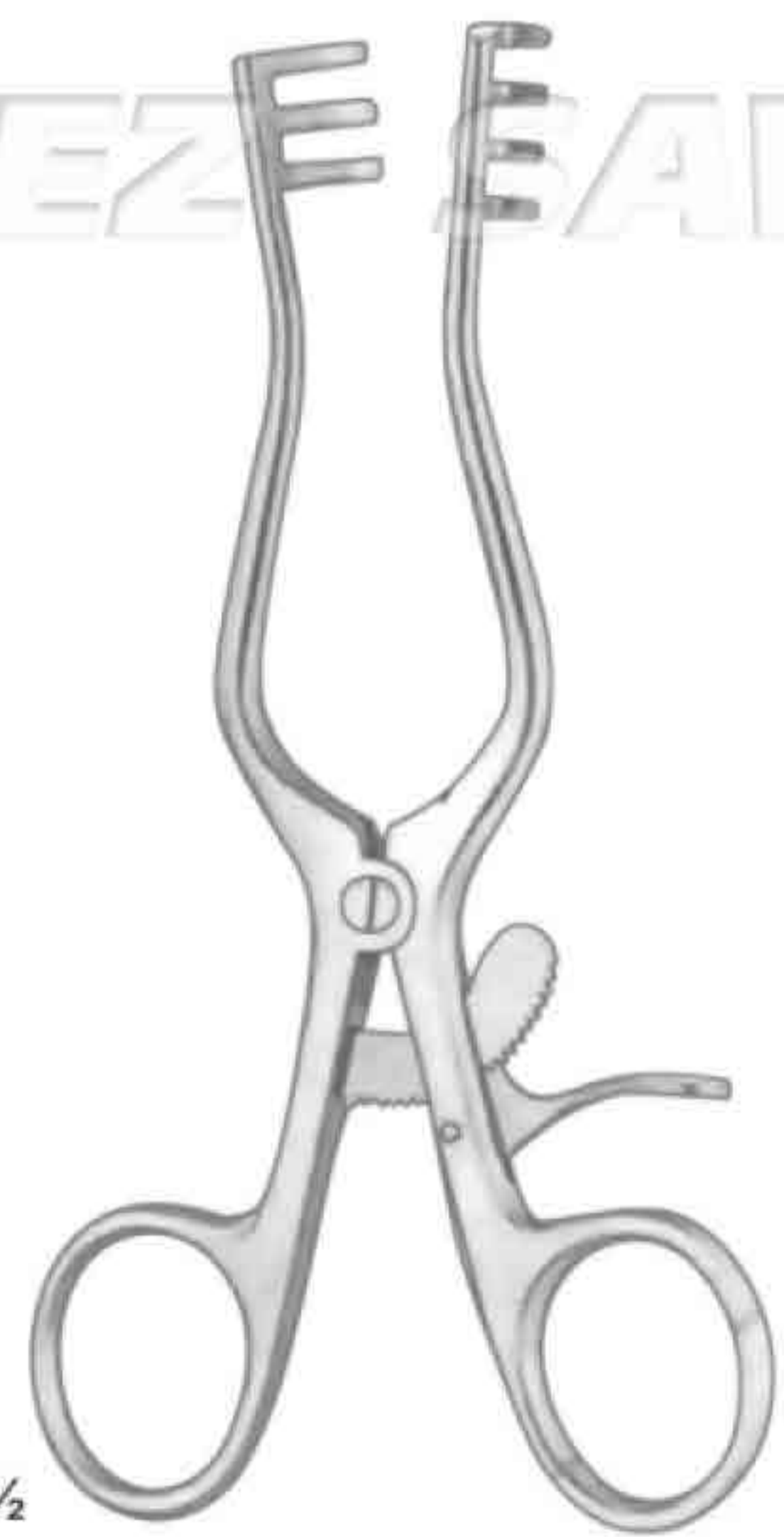


SSC-11-21-62
3.0 cm / 5"
13 x 4 teeth
sharp

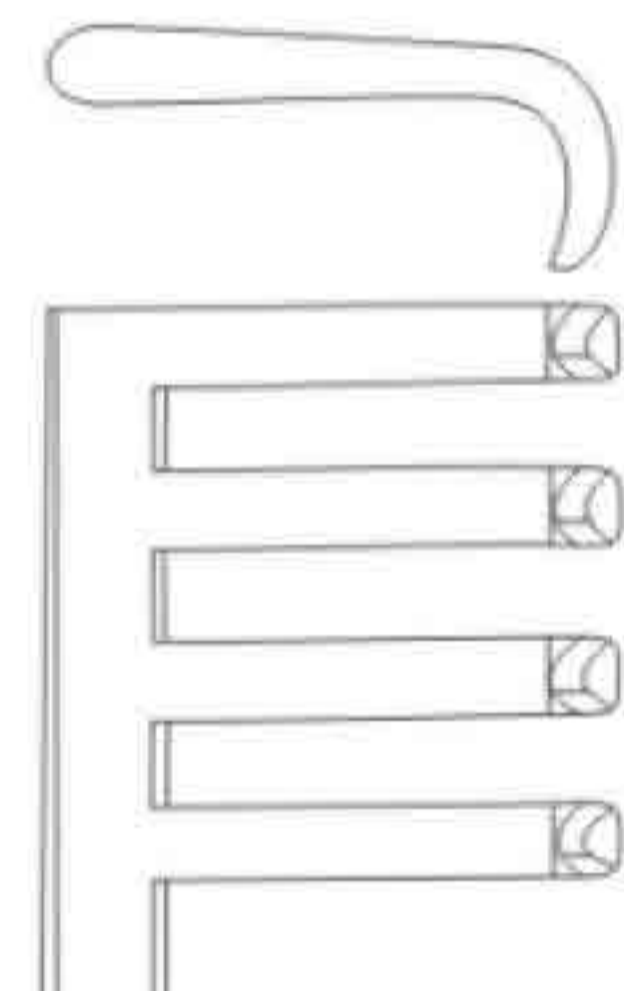


SSC-11-21-63
16.5 cm / 6 1/2"
3 x 4 teeth
sharp

65 mm 80mm

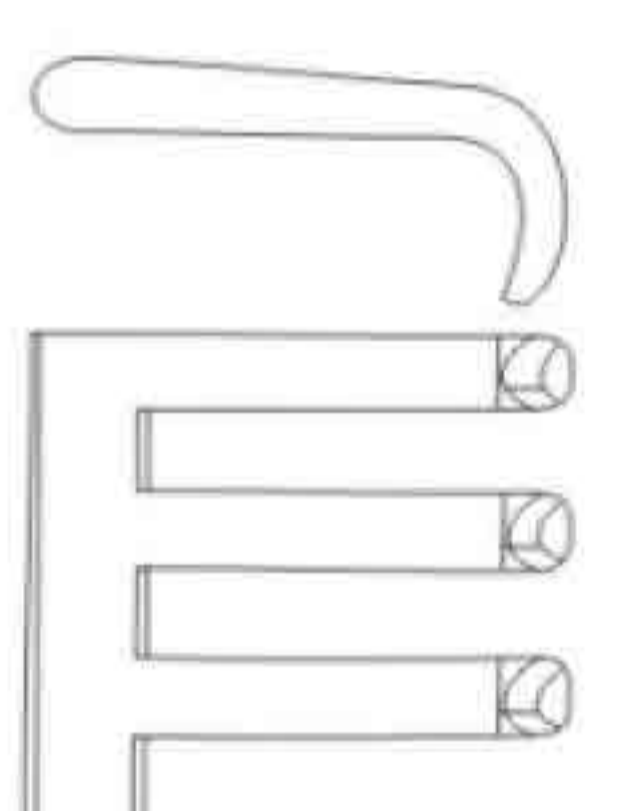


SSC-11-21-64
13.0 cm / 5"
3 x 4 teeth
blunt



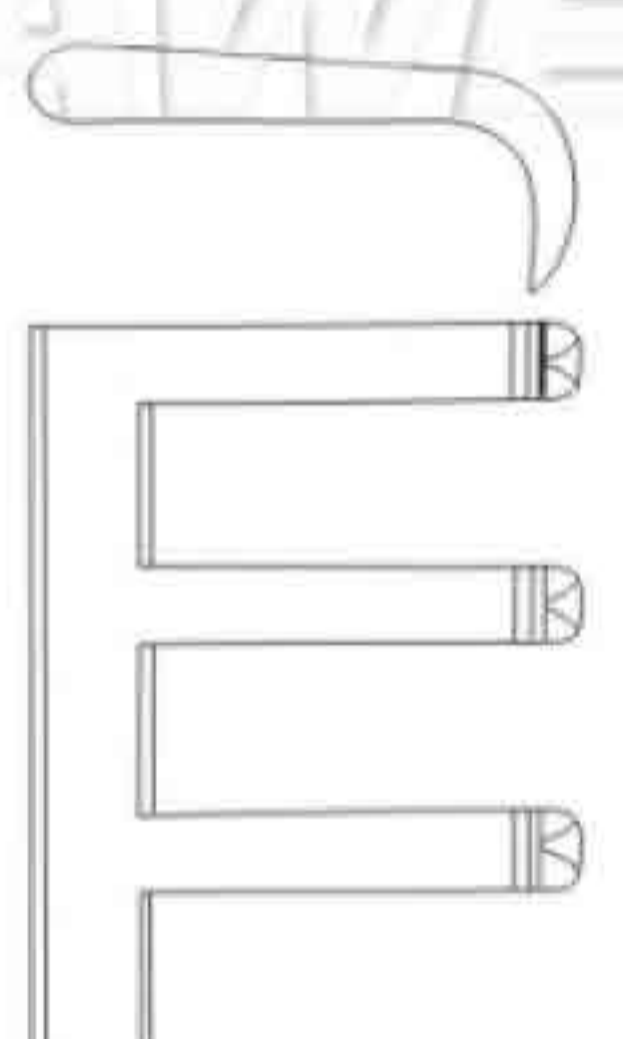
SSC-11-21-65
16.5 cm / 6 1/2"
3 x 4 teeth
blunt

35 mm



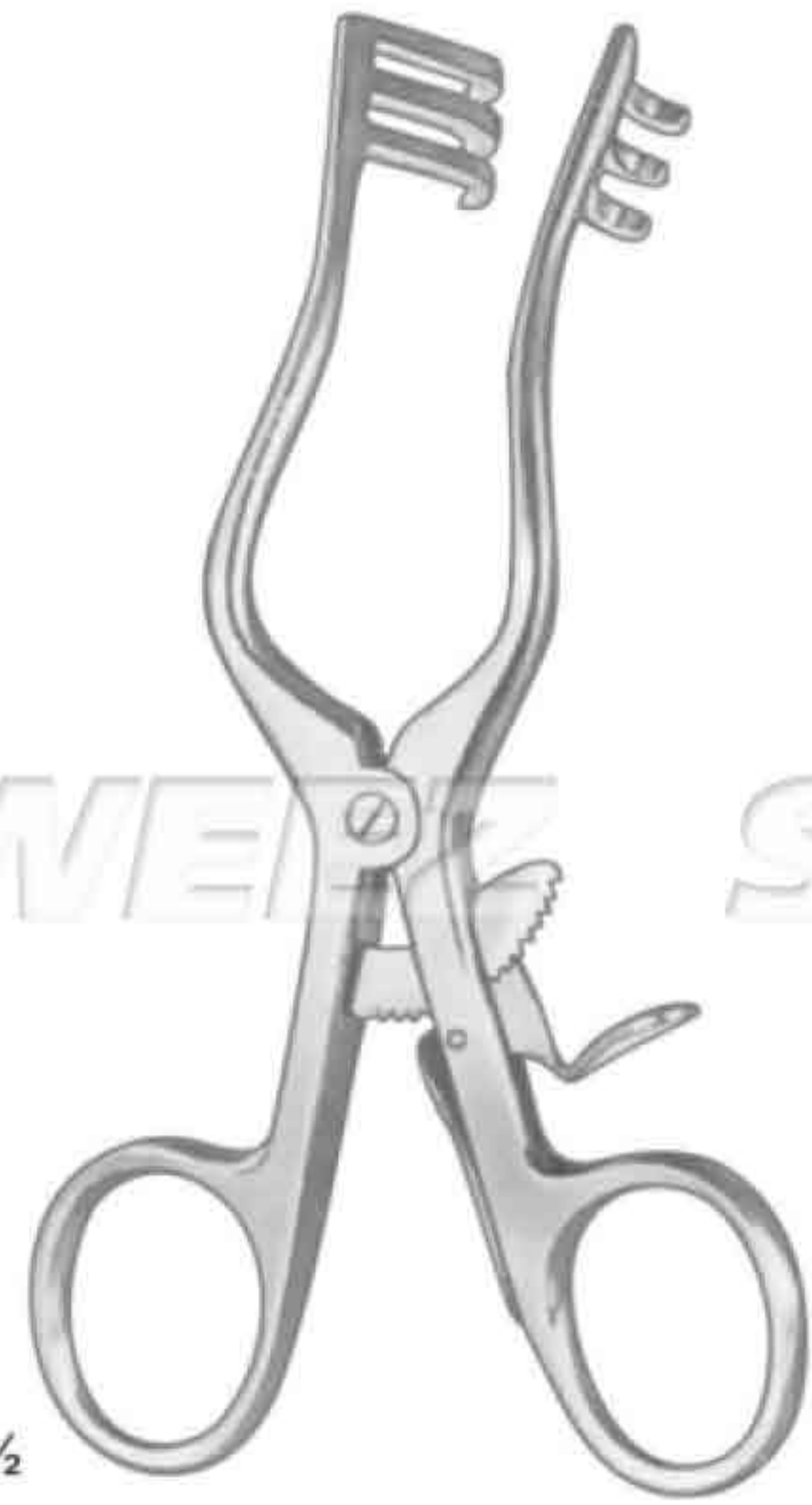
SSC-11-21-61
10.5 cm / 6 1/4"
2 x 3 teeth
blunt

Weitlaner-Loktite

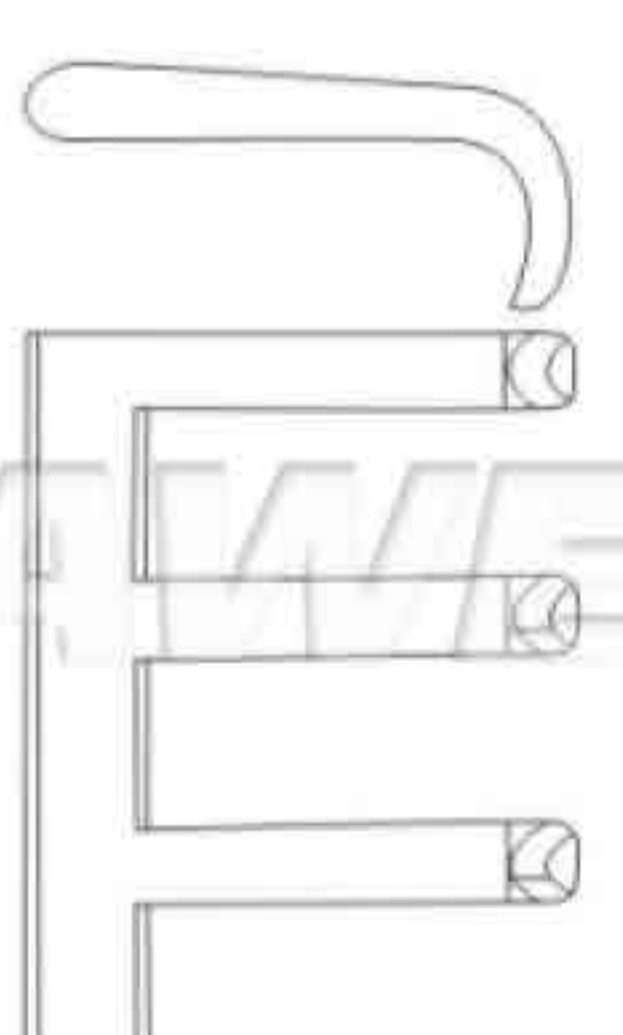


SSC-11-21-66
13.0 cm / 5"
sharp

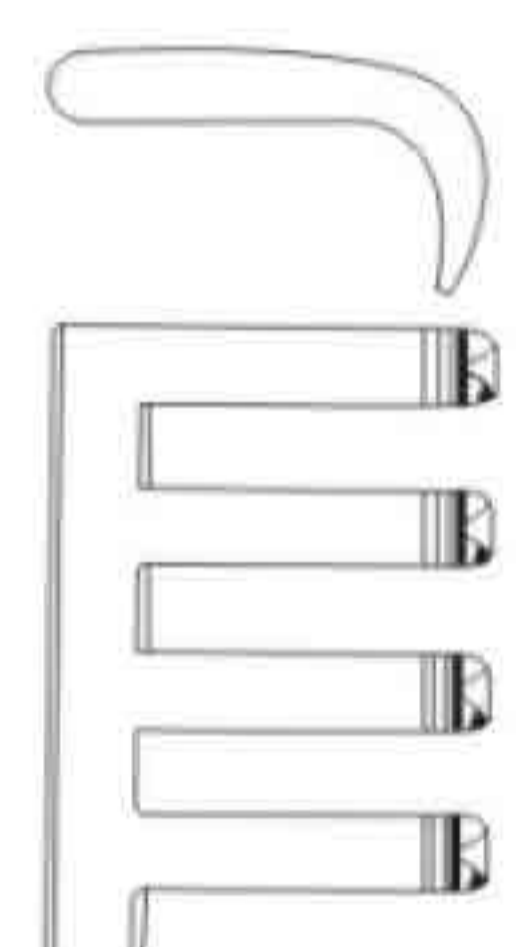
50 mm



Weitlaner-Wullstein



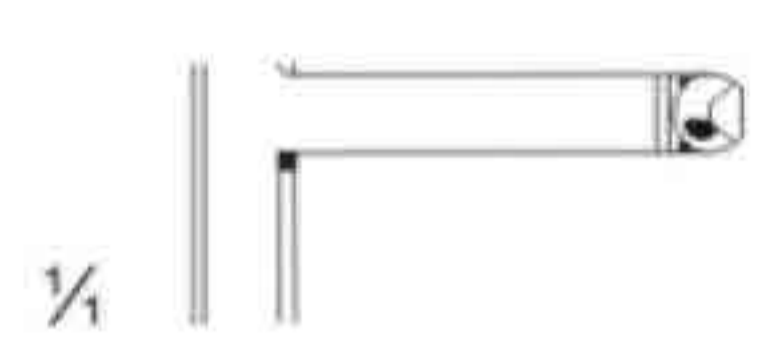
SSC-11-21-67
13.0 cm / 5"
blunt



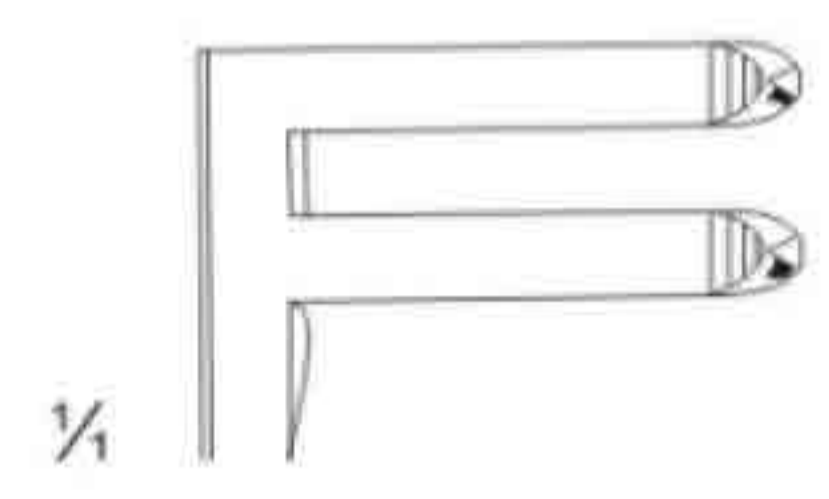
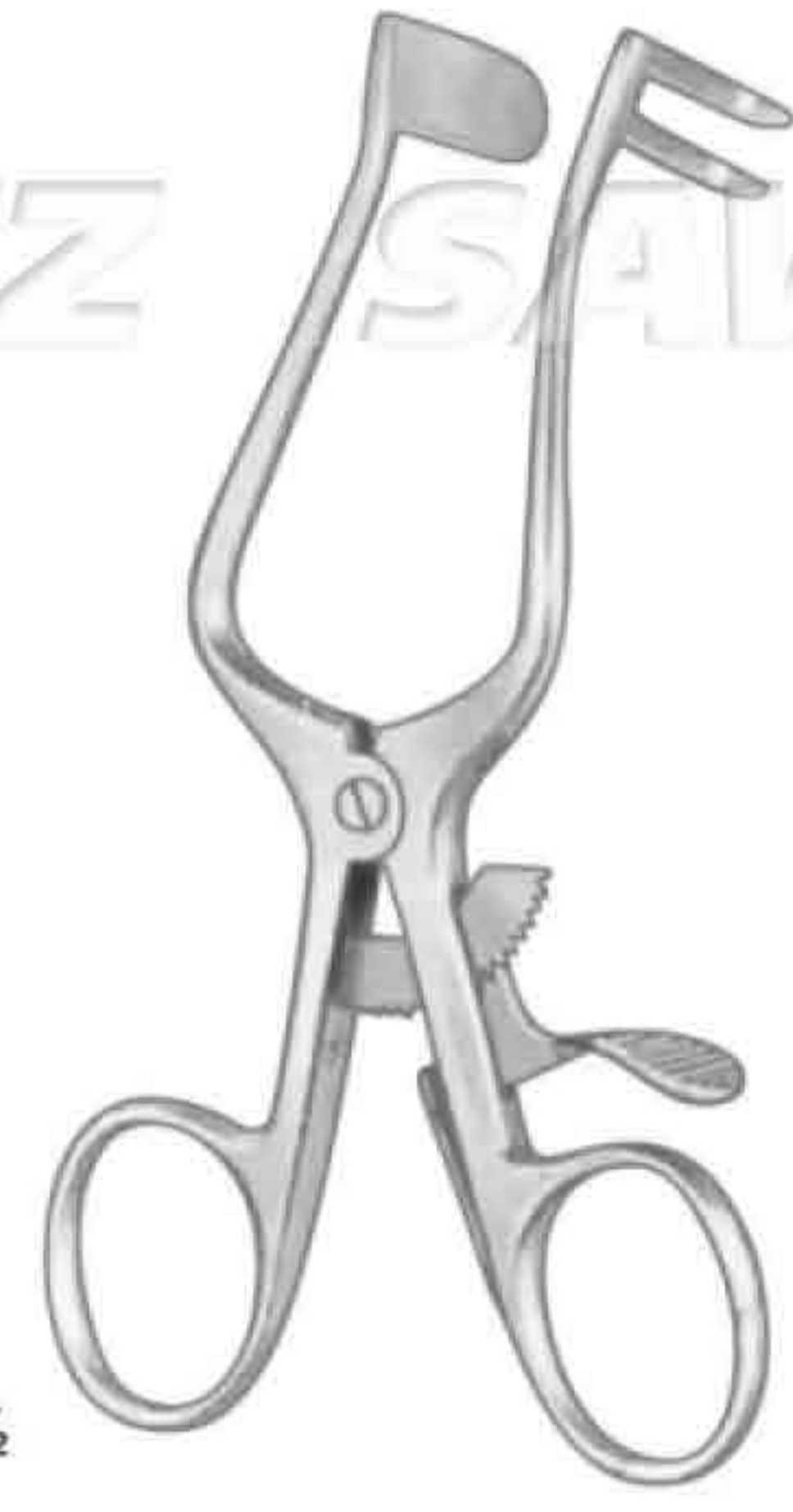
SSC-11-21-68
15.0 cm / 6"
Sharp



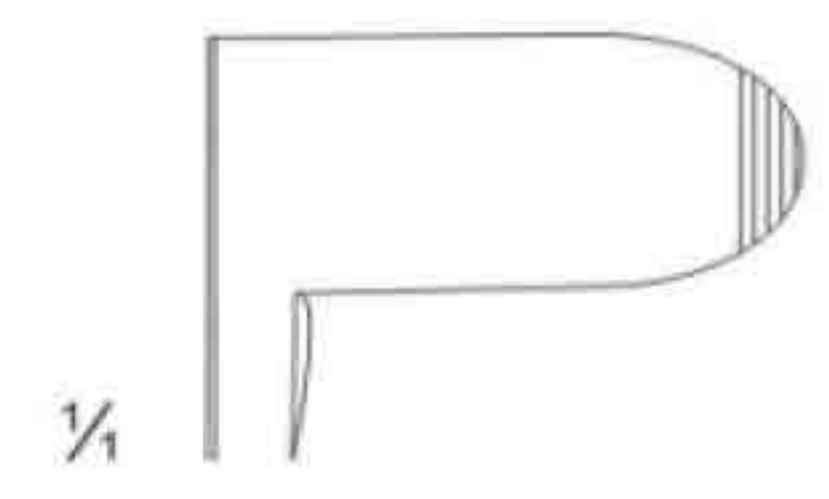
Mollison



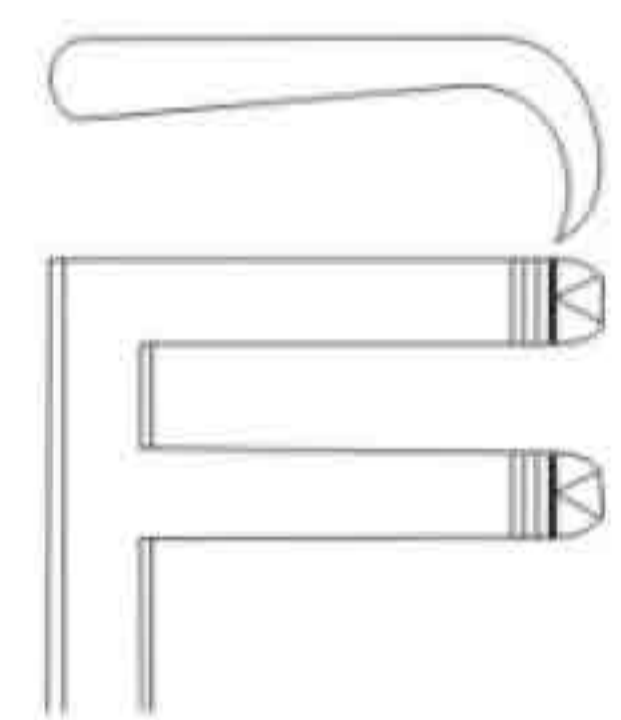
SSC-11-21-69
13.0 cm / 5"
2 x 2 teeth
blunt



SSC-11-21-71
11.0 cm / 4 1/4"
2 teeth
blunt



SSC-11-21-72
11.0 cm / 4 1/4"
2 teeth
blunt



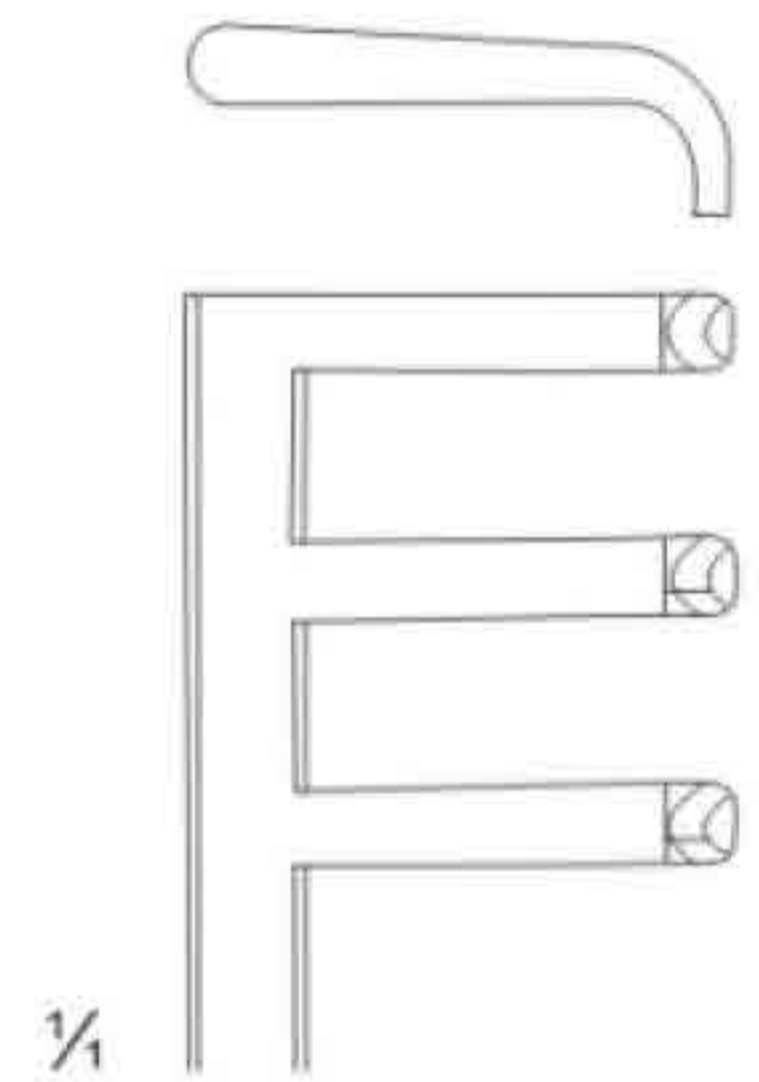
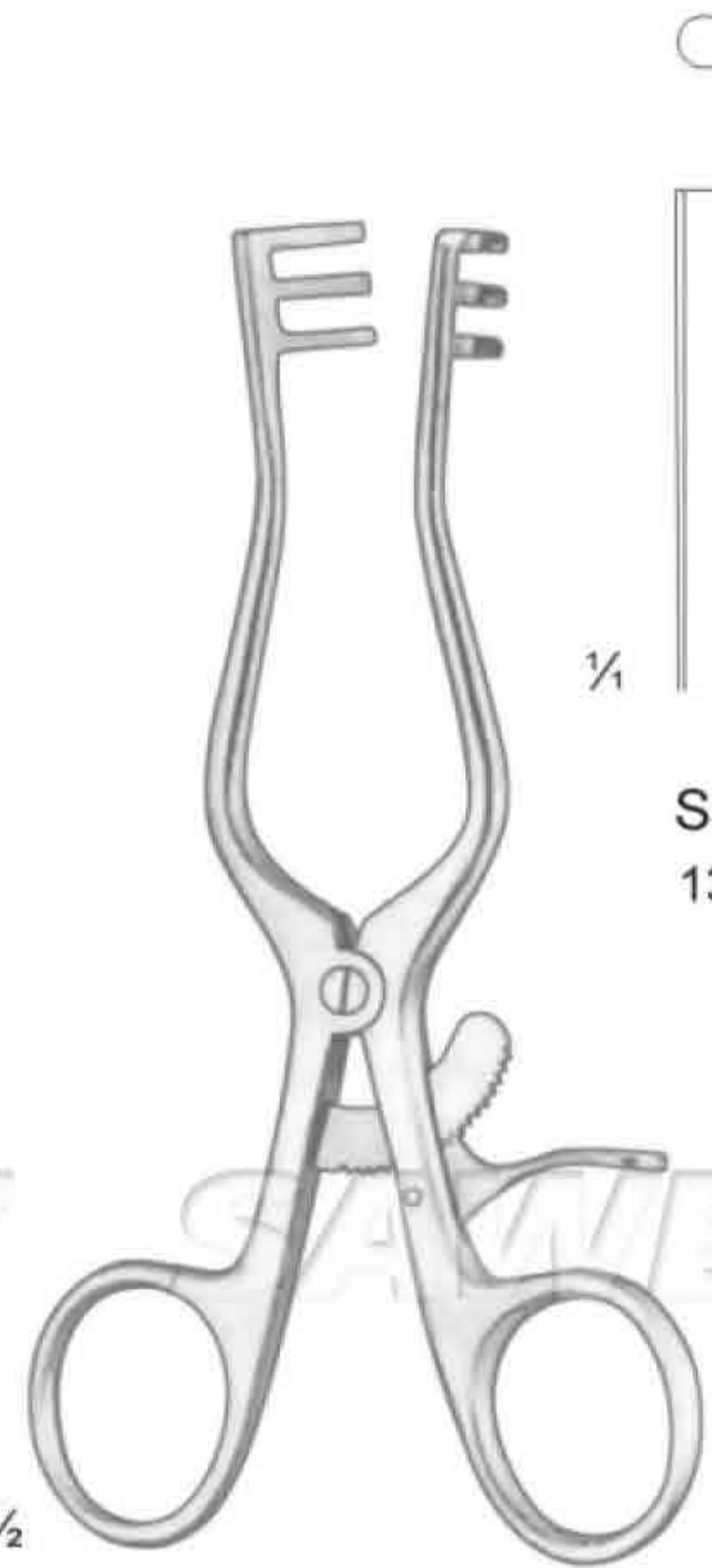
SSC-11-21-70
13.0 cm / 5"
2 x 2 teeth
sharp

Plester

Plester

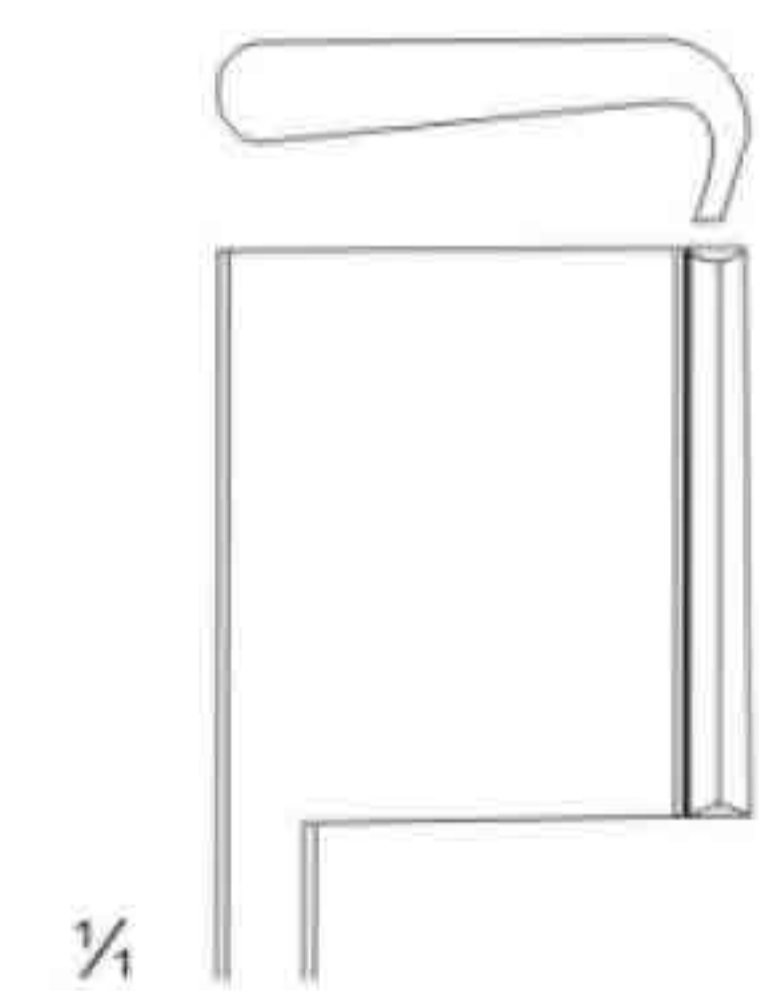
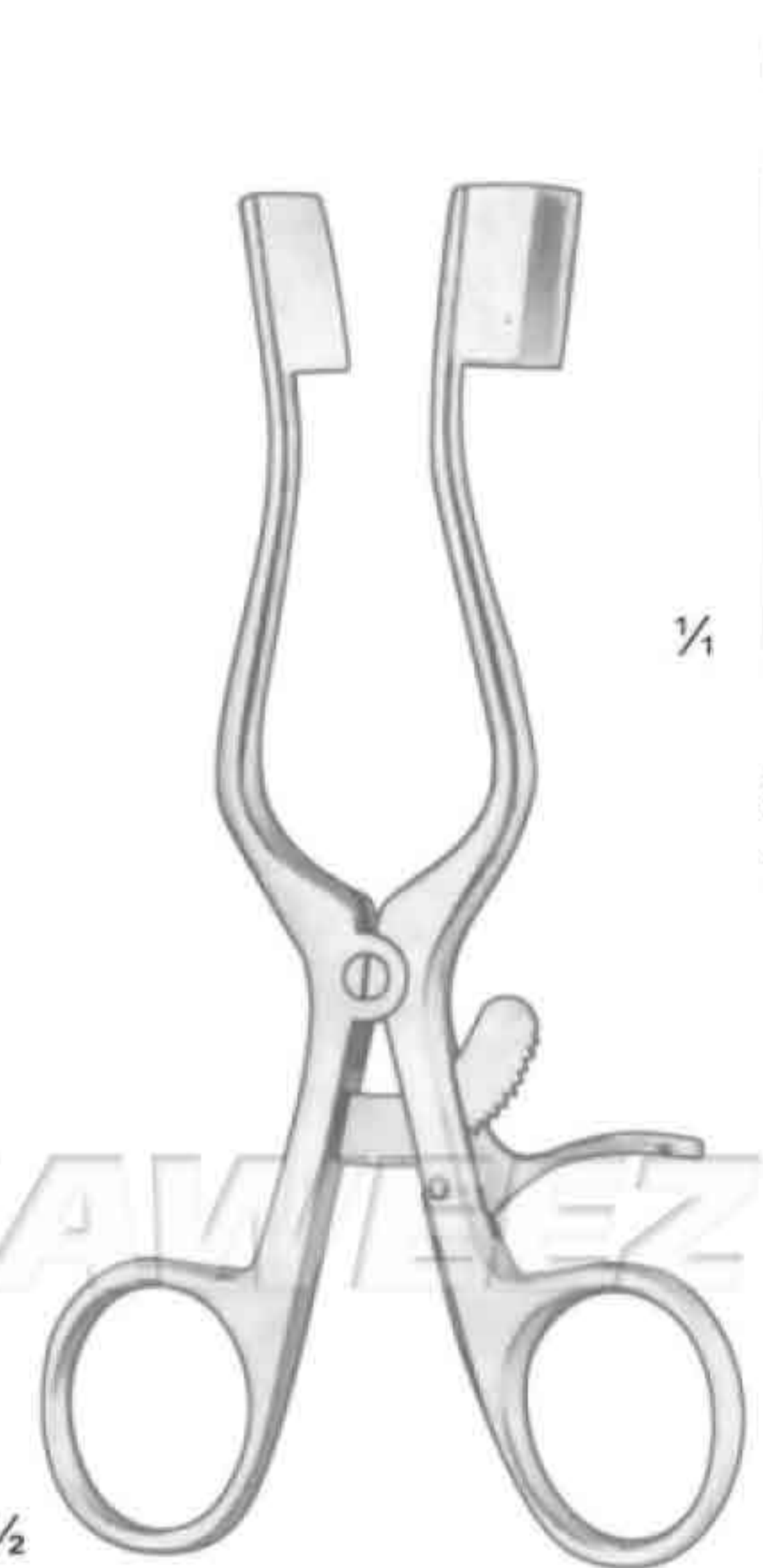
Plester

SAWEEZ SAWEEZ SAWEEZ SAWEEZ



SSC-11-21-73
13.0 cm / 5"

Milligan



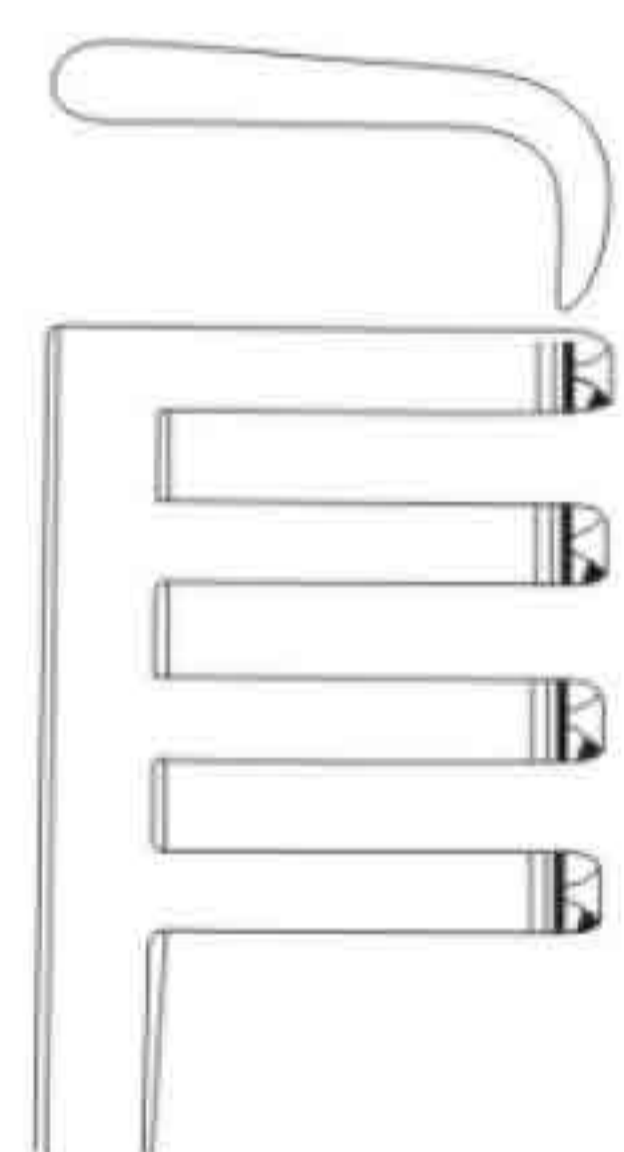
SSC-11-21-74
13.0 cm / 5"

Weitlaner-Baby

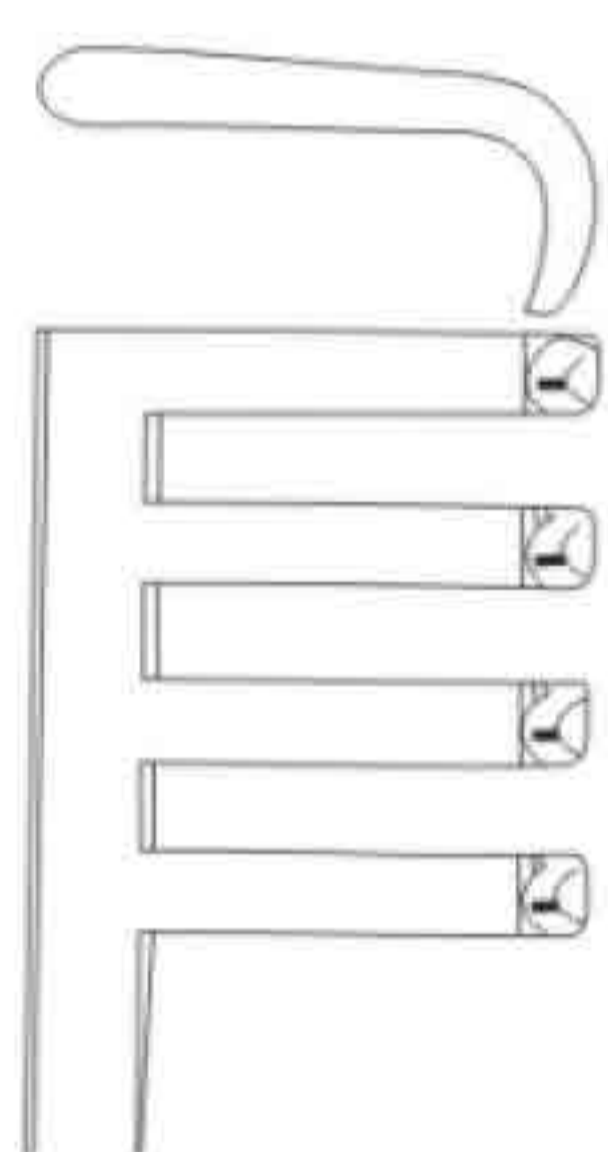
SAWEEZ SAWEEZ SAWEEZ SAWEEZ



SAWEEZ SAWEEZ SAWEEZ SAWEEZ



SSC-11-21-75
sharp



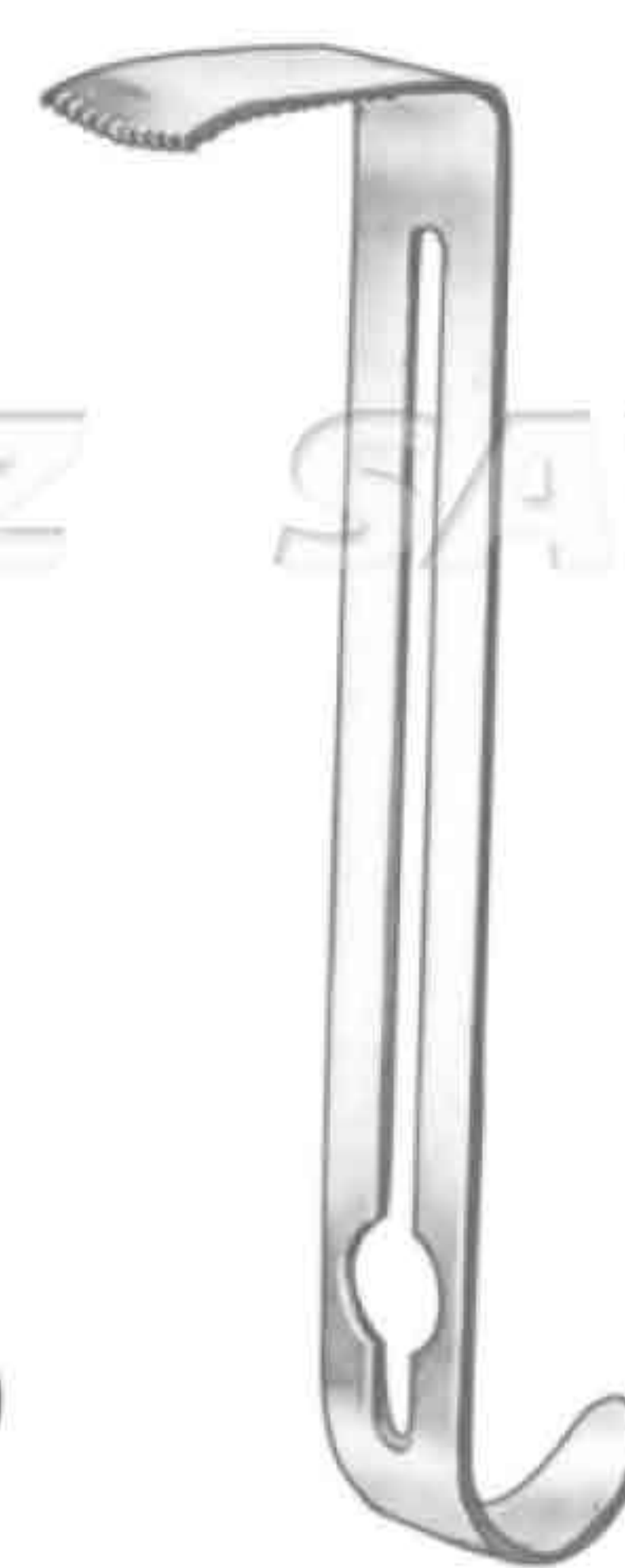
SSC-11-21-76
blunt



SSC-11-21-77
16 mm x 19 mm
5/8" x 3/4"

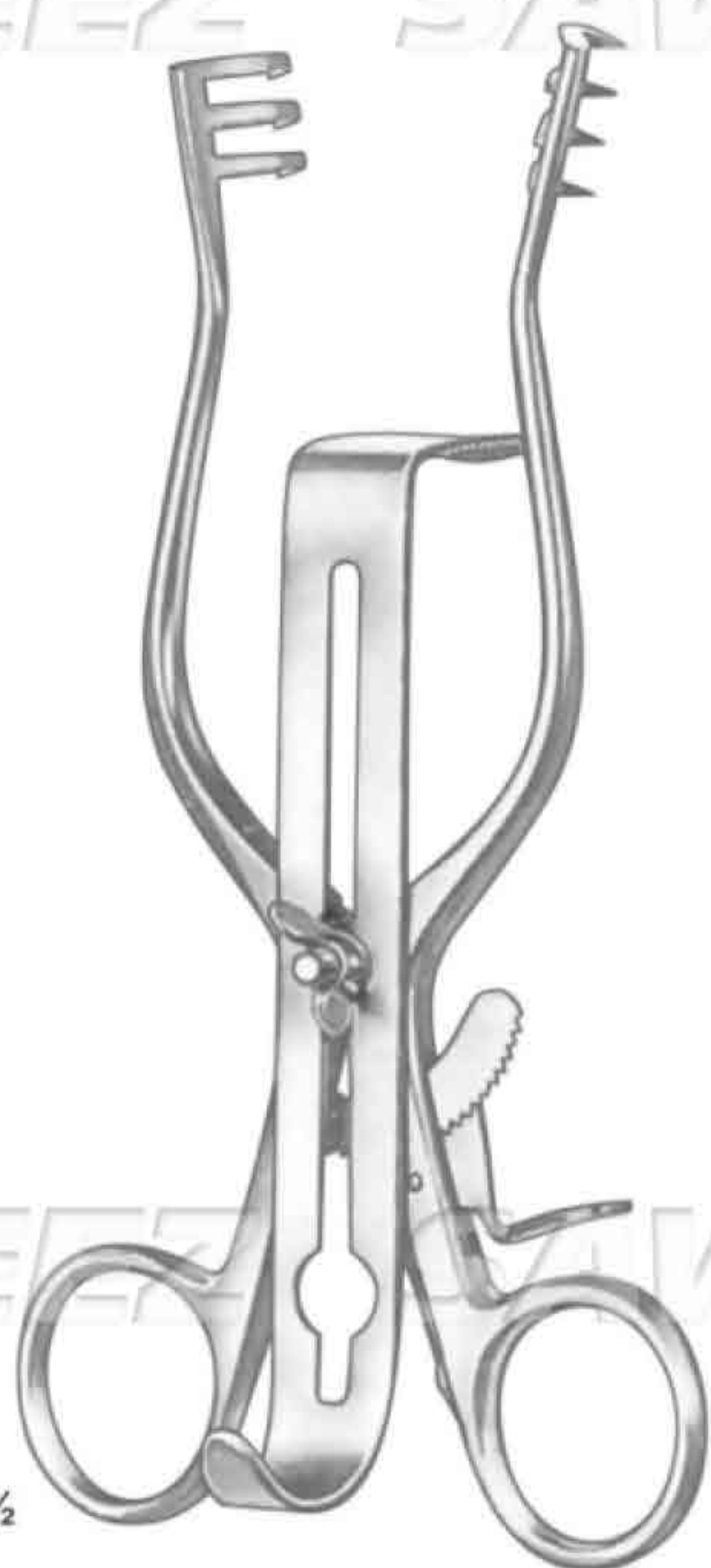


SSC-11-21-78
16 mm x 25 mm
5/8" x 1"



SSC-11-21-79
16 mm x 32 mm
5/8" x 1 1/4"

SAWEEZ SAWEEZ SAWEEZ SAWEEZ



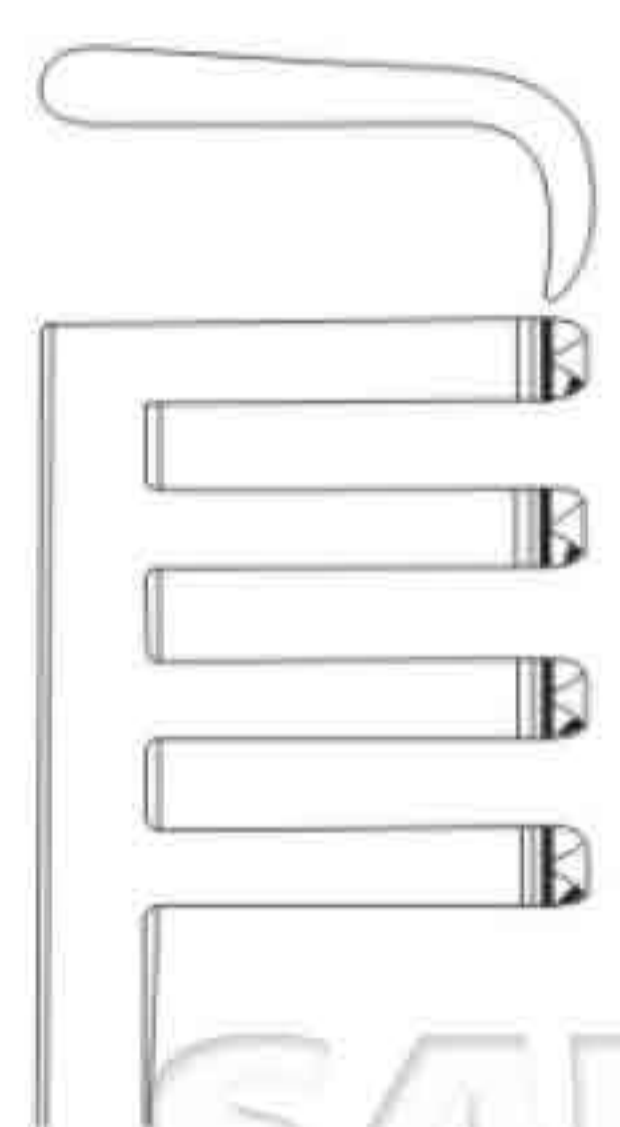
1/2

Henley
16.5 cm / 6 1/2"
3 x 4 teeth

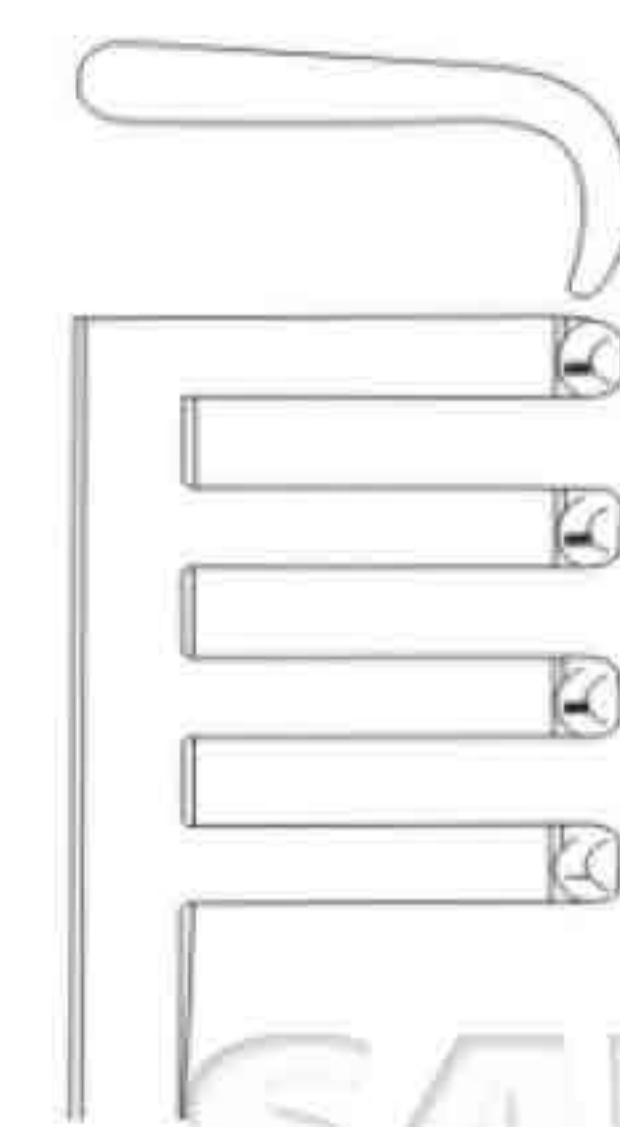
SAWEEZ SAWEEZ SAWEEZ SAWEEZ



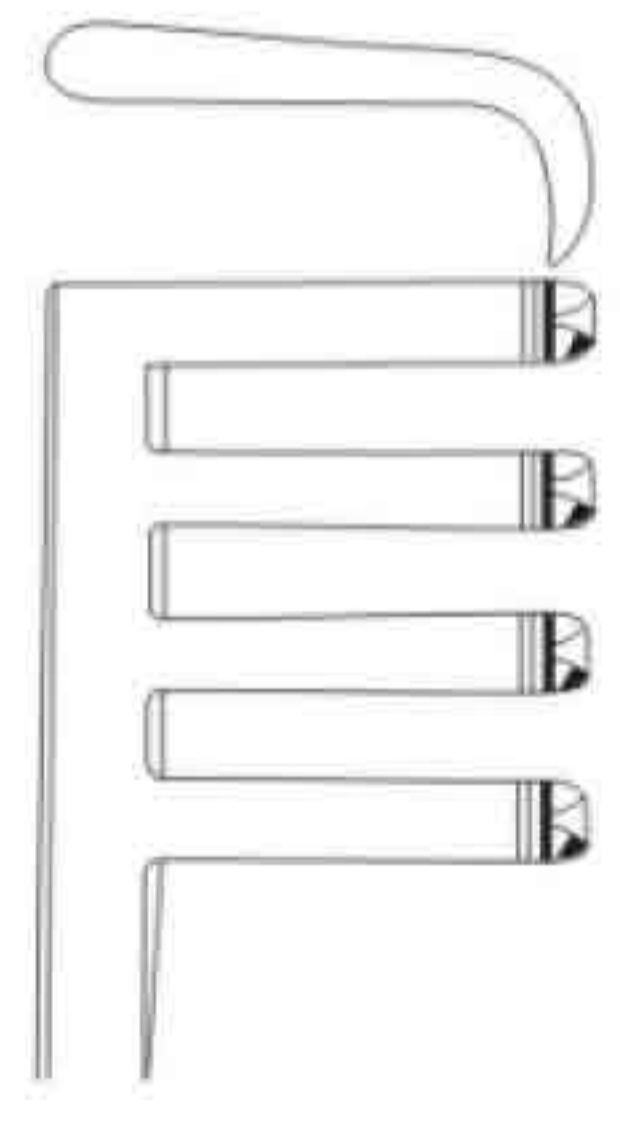
SAWEEZ SAWEEZ ¼ SAWEEZ SAWEEZ



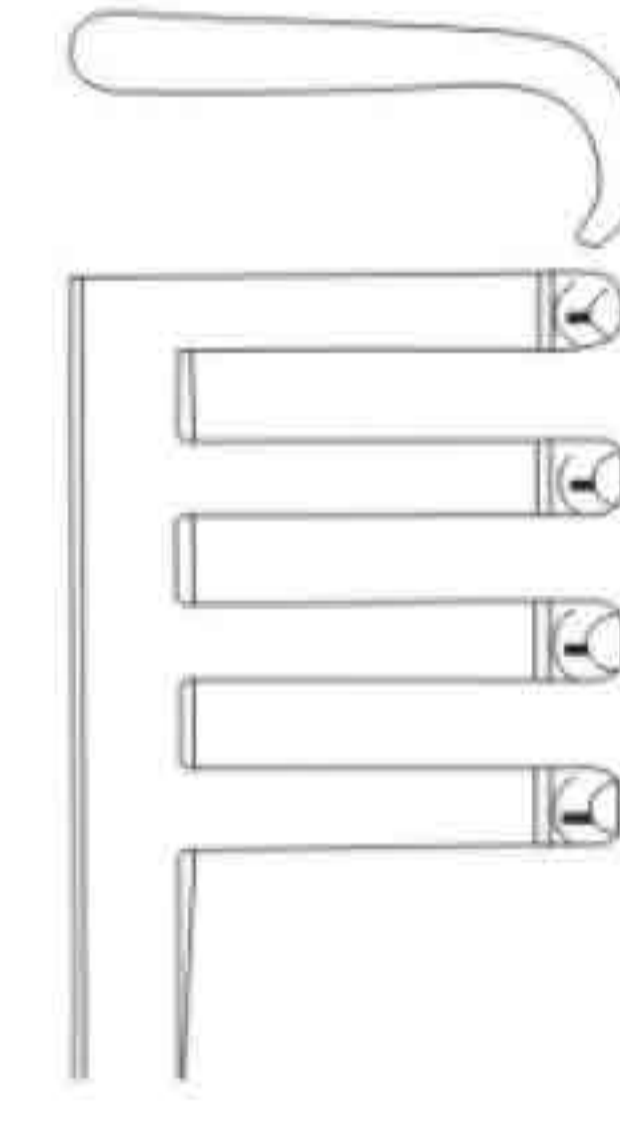
SSC-11-21-80
13.0 cm / 5"



SSC-11-21-81
13.0 cm / 5"



SSC-11-21-82
16.0 cm / 6¼"



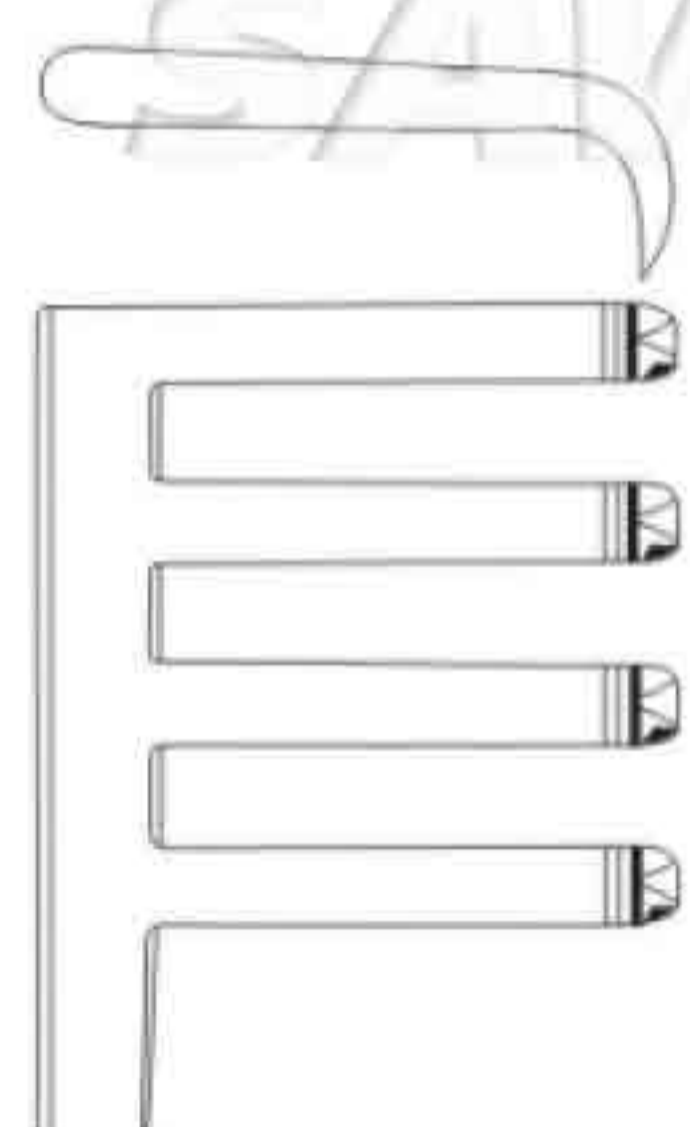
SSC-11-21-83
16.0 cm / 6¼"

SAWEEZ SAWEEZ SAWEEZ SAWEEZ

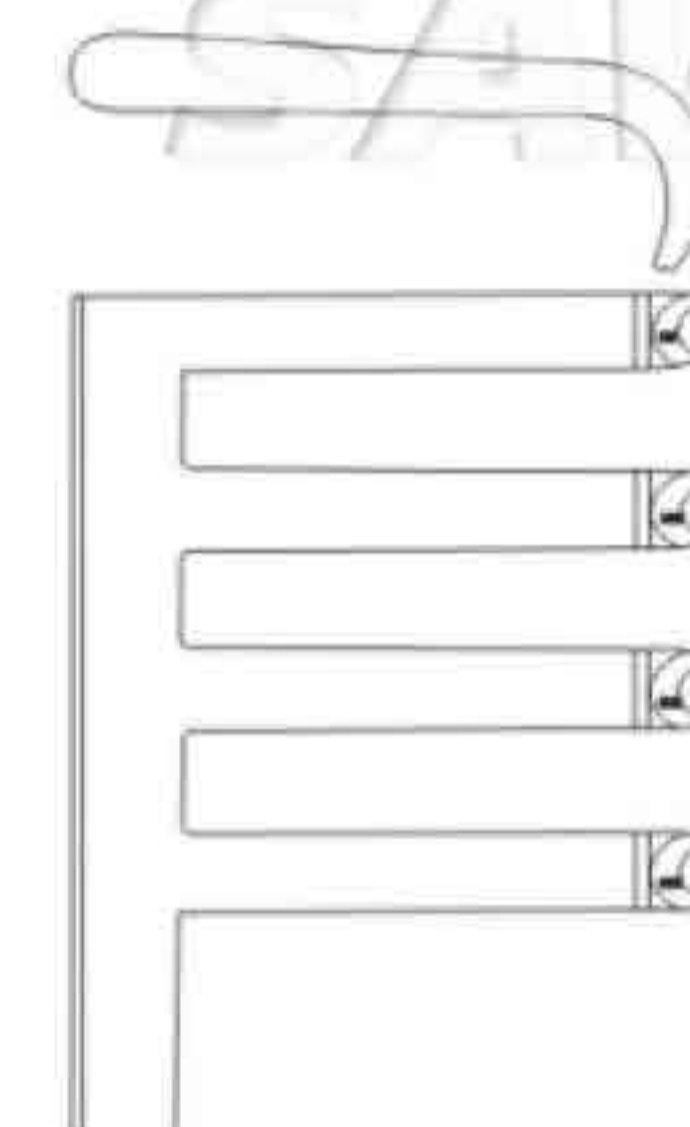


½

Adson
3 x 4 teeth

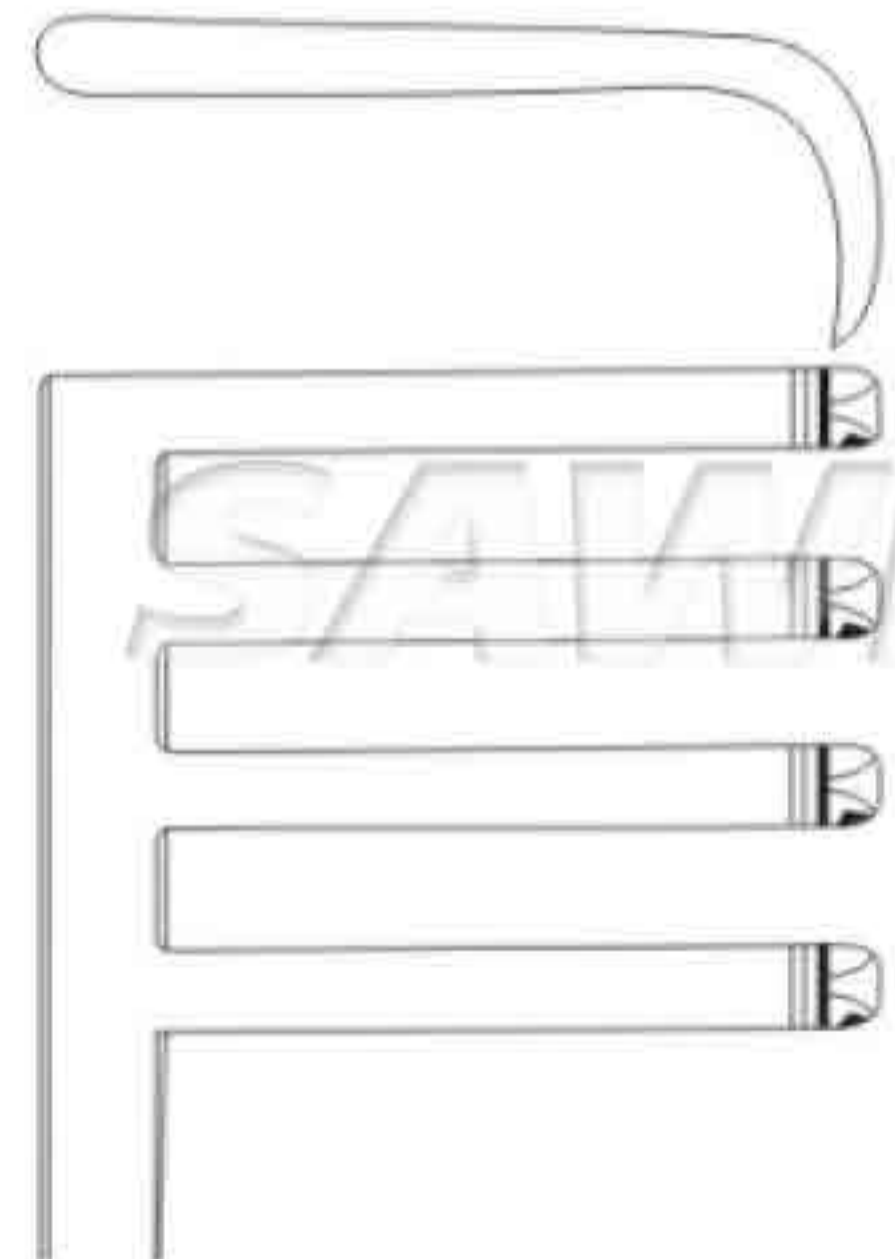


SSC-11-21-84
20.0 cm / 8"



SSC-11-21-85
20.0 cm / 8"

SAWEEZ SAWEEZ SAWEEZ SAWEEZ



SSC-11-21-86
26.0 cm / 10¼"
sharp

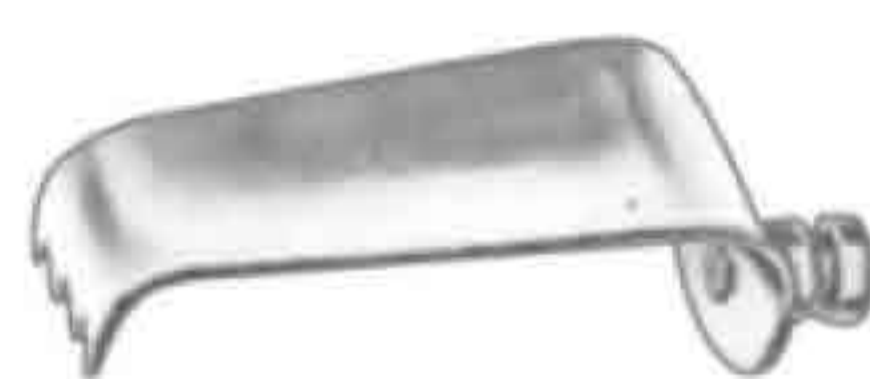


SSC-11-21-87
26.0 cm / 10¼"
blunt



EXCHANGEABLE BLADES

SAWEEZ SAWEEZ SAWEEZ SAWEEZ



SSC-11-21-88 = 40.0 mm



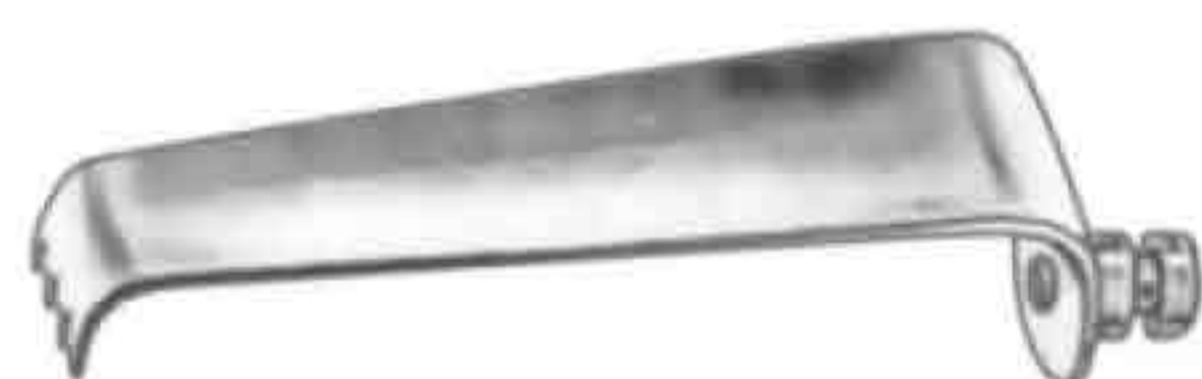
SSC-11-21-89 = 45.0 mm



SSC-11-21-90 = 50.0 mm



SSC-11-21-91 = 55.0 mm



SSC-11-21-92 = 60.0 mm

SAWEEZ SAWEEZ SAWEEZ SAWEEZ

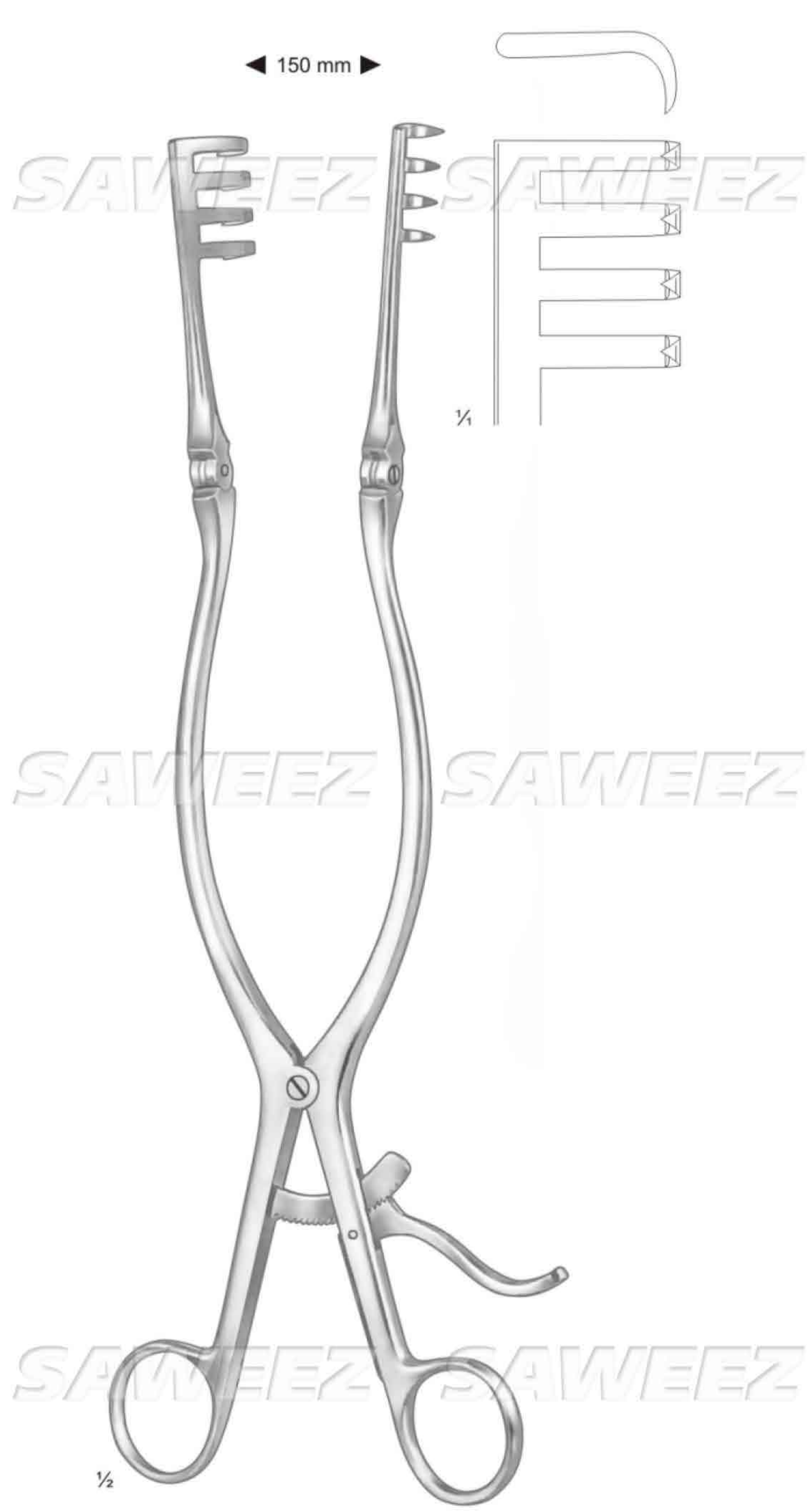
SAWEEZ SAWEEZ SAWEEZ SAWEEZ



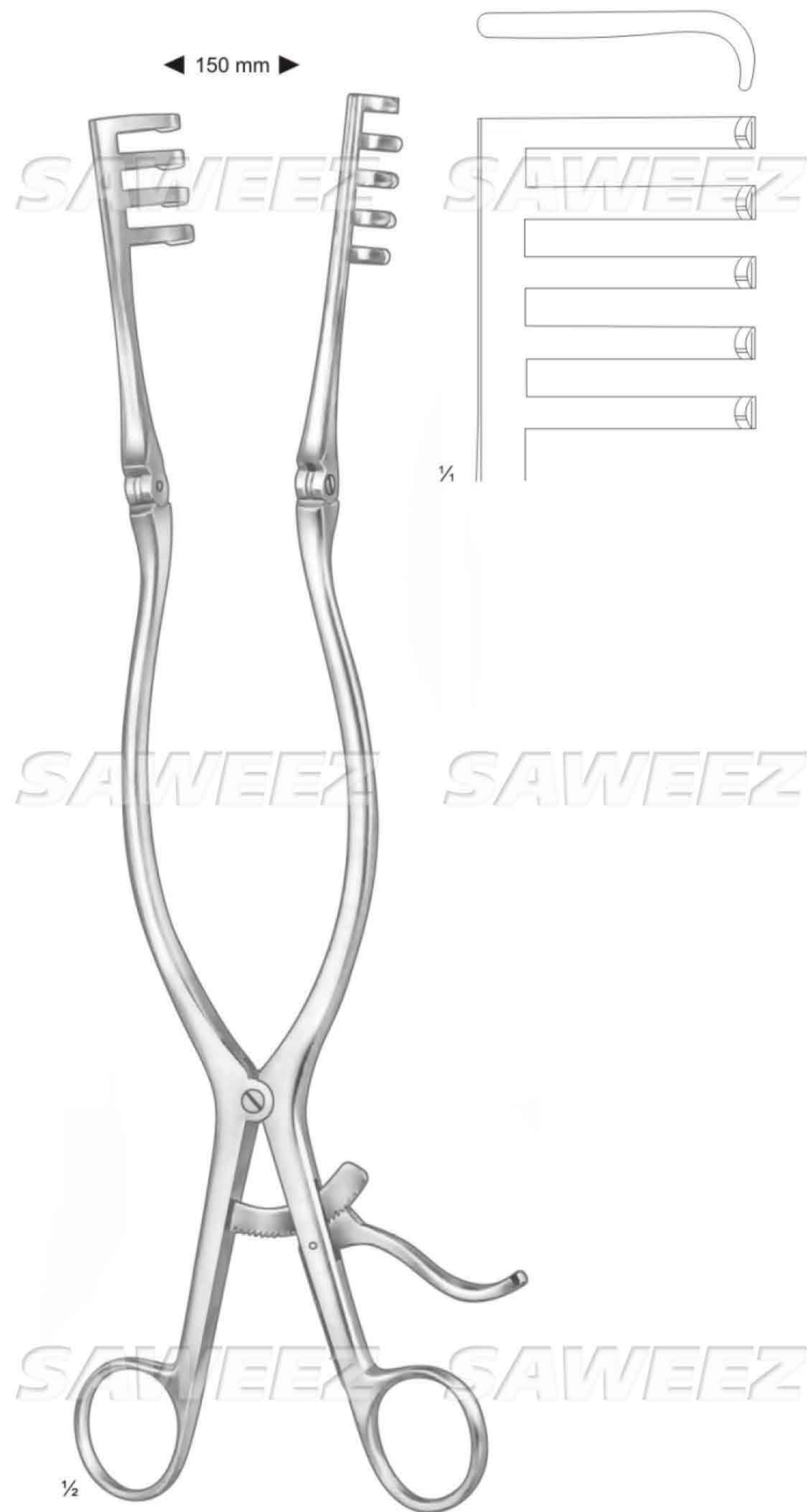
Cloward

SSC-140-1090 Retractor without blades
25.0 cm / 10"

SSC-140-1091 Retractor complete with two blades
25.0 cm / 10"



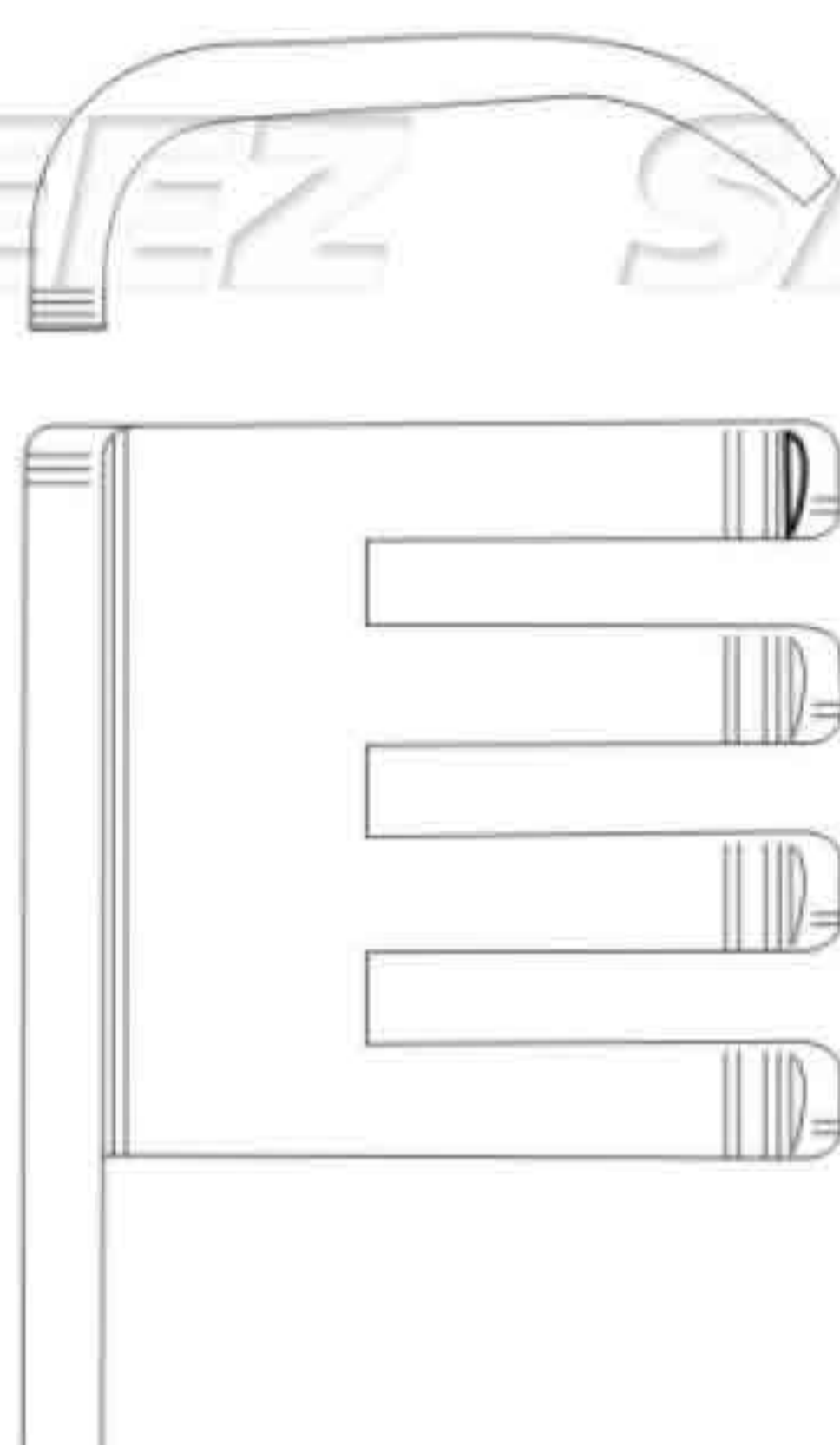
Beckmann
 SSC-11-21-93
 31.0 cm / 12 1/4"
 4 x 4 teeth



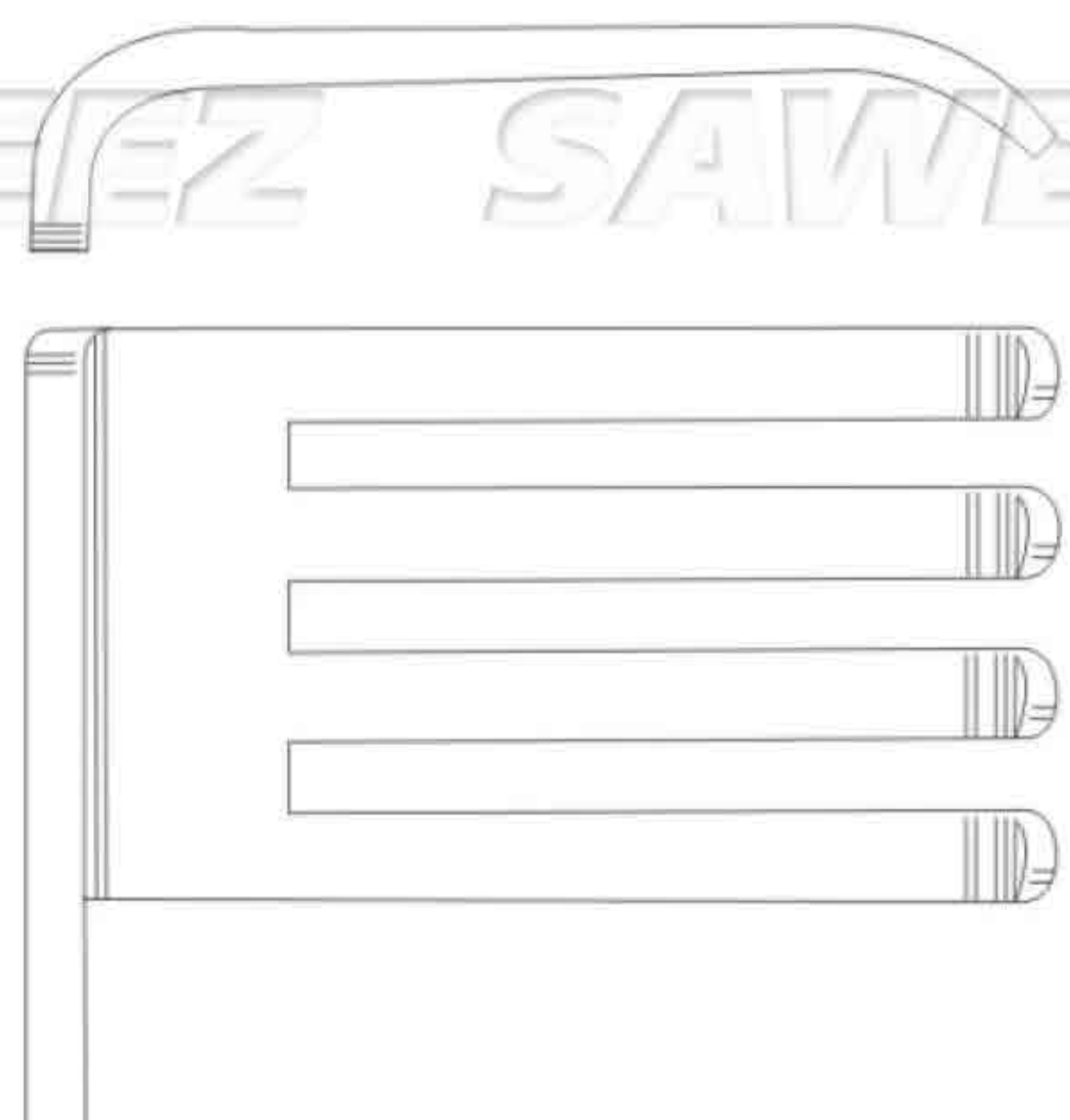
Adson
 SSC-11-21-94
 32.0 cm / 12 1/2"
 4 x 5 teeth



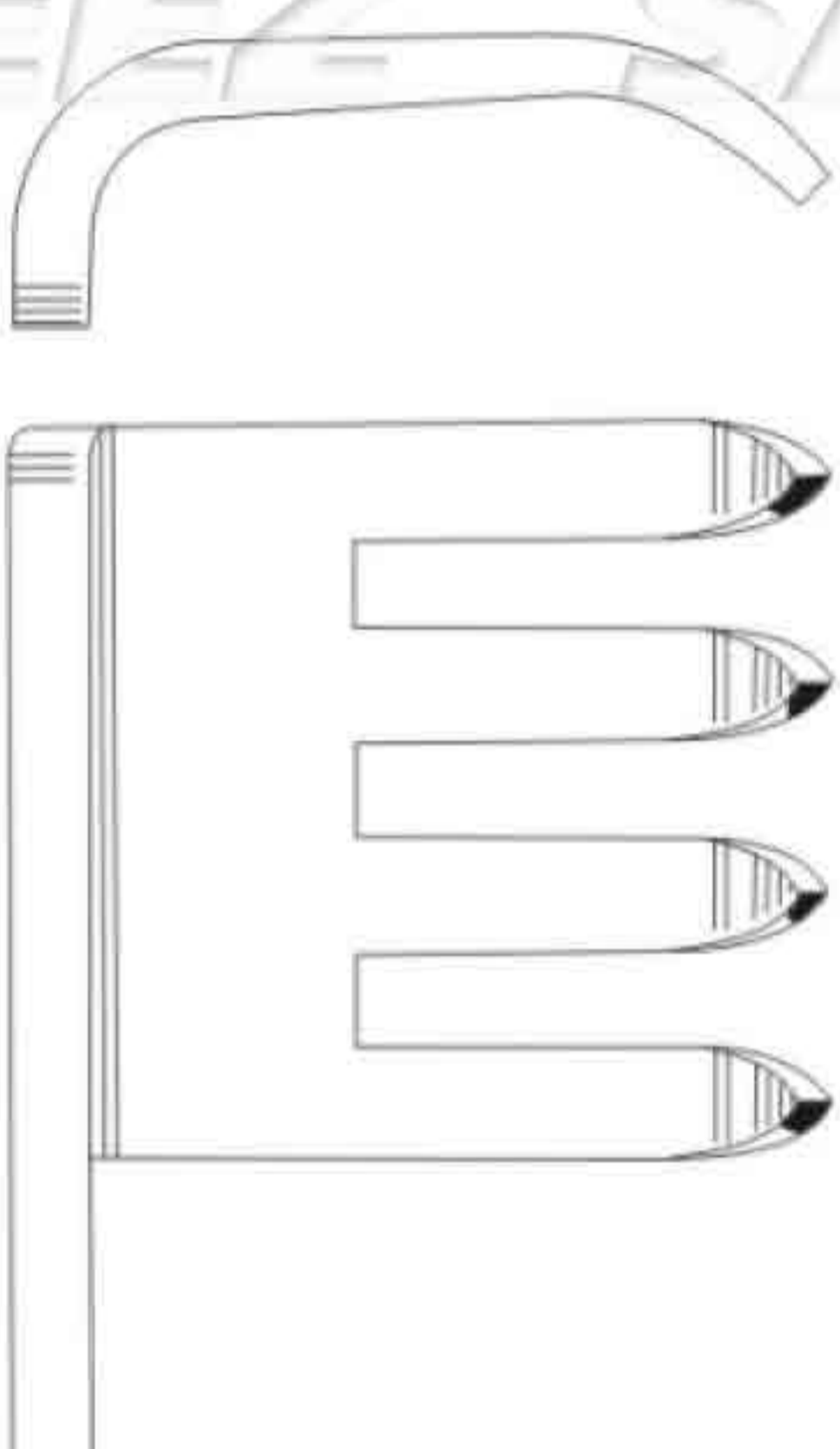
Beckmann-Adson
31.0 cm / 12¼"
4 x 4 teeth



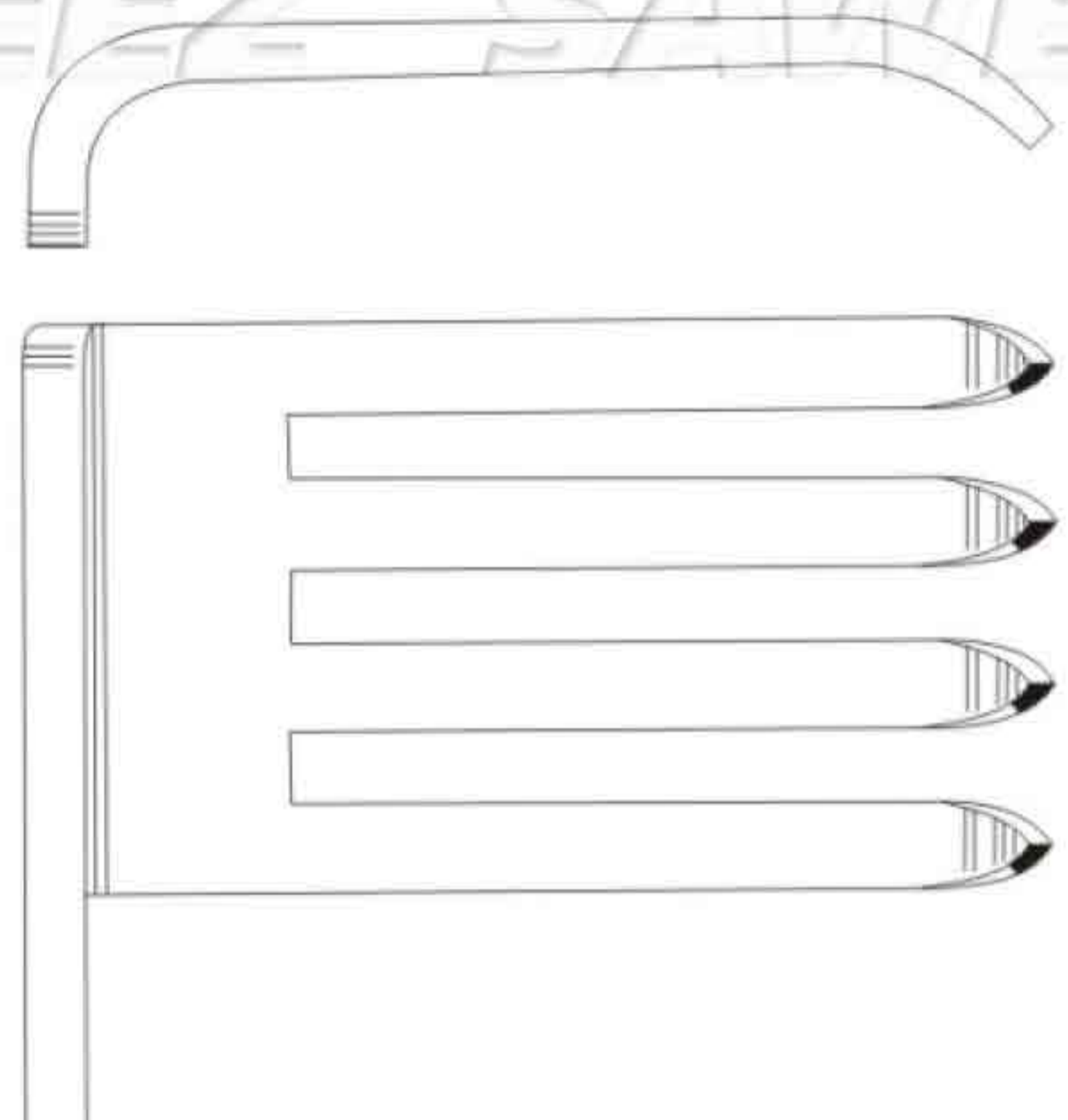
SSC-11-21-96
blunt



SSC-11-21-97
blunt



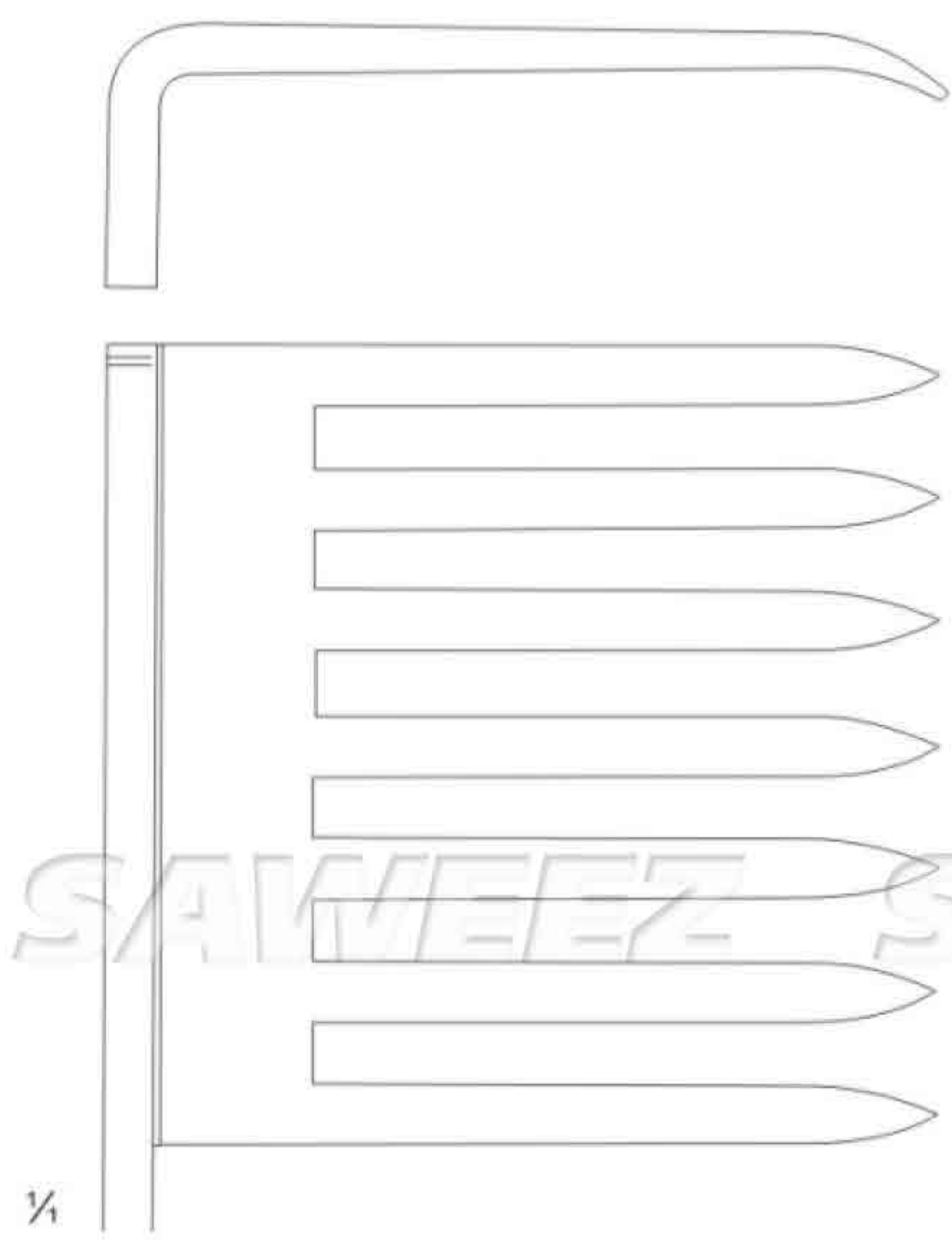
SSC-11-21-98
sharp



SSC-11-21-99
sharp



SAWEEZ SAWEEZ SAWEEZ SAWEEZ



SAWEEZ SAWEEZ SAWEEZ SAWEEZ

SAWEEZ SAWEEZ SAWEEZ SAWEEZ

1/2

Beckmann-Eaton
SSC-11-21-95
32.0 cm / 12 1/2"

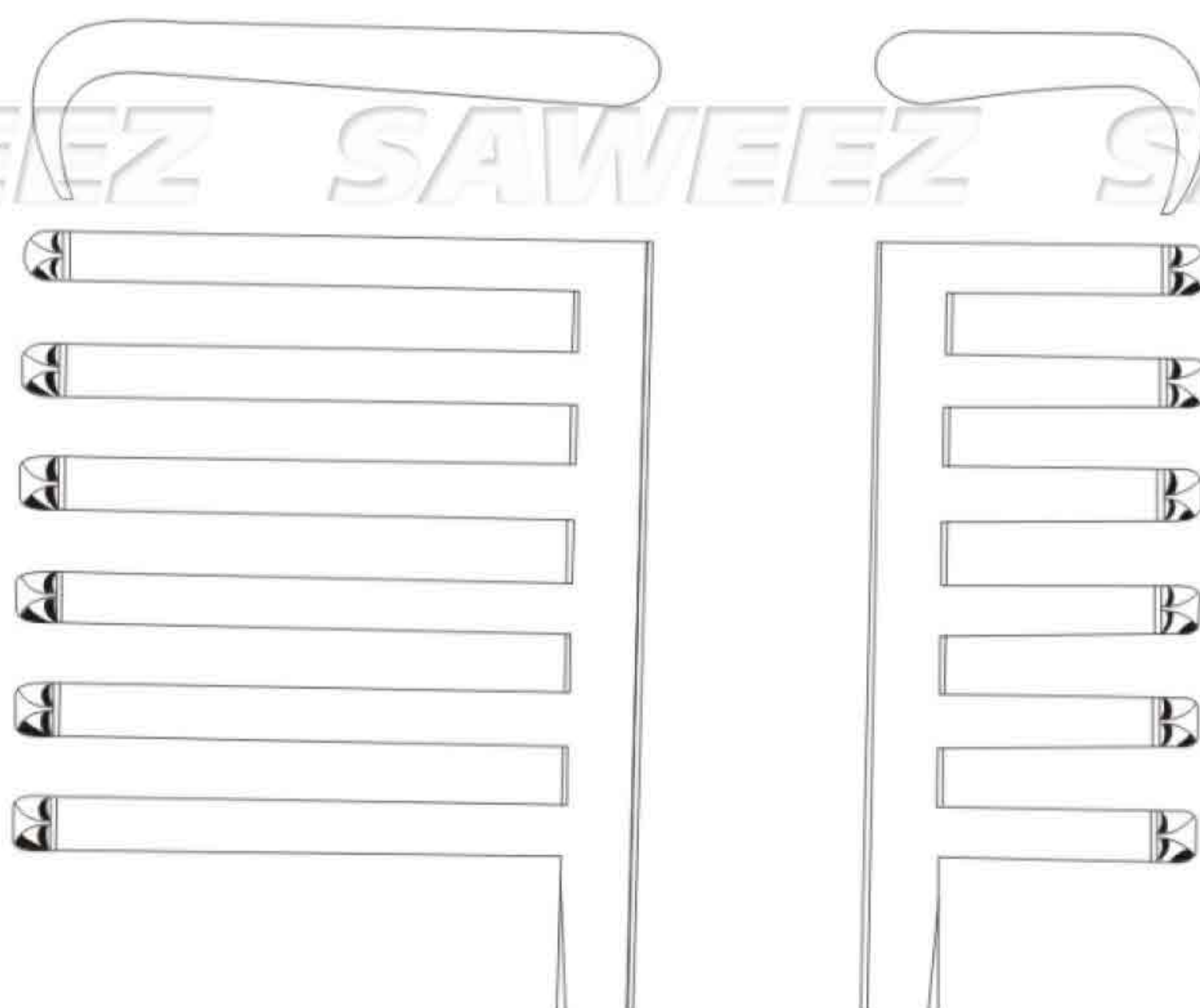


SAWEEZ SAWEEZ SAWEEZ SAWEEZ



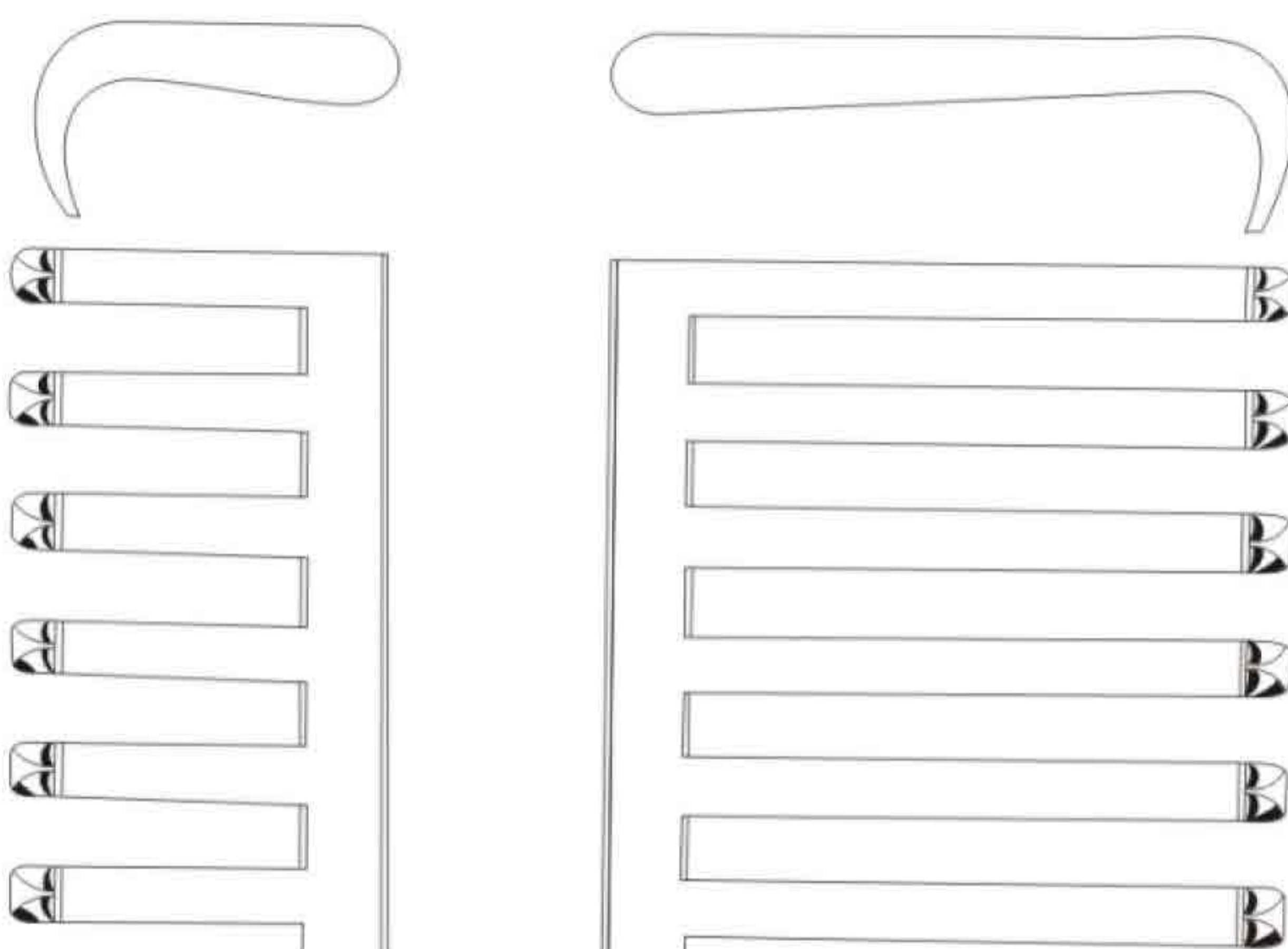
1/2

Hemi-Laminectomy
27.0 cm / 10 3/4"
6 x 6 teeth



SSC-11-22-00

SAWEEZ SAWEEZ SAWEEZ SAWEEZ

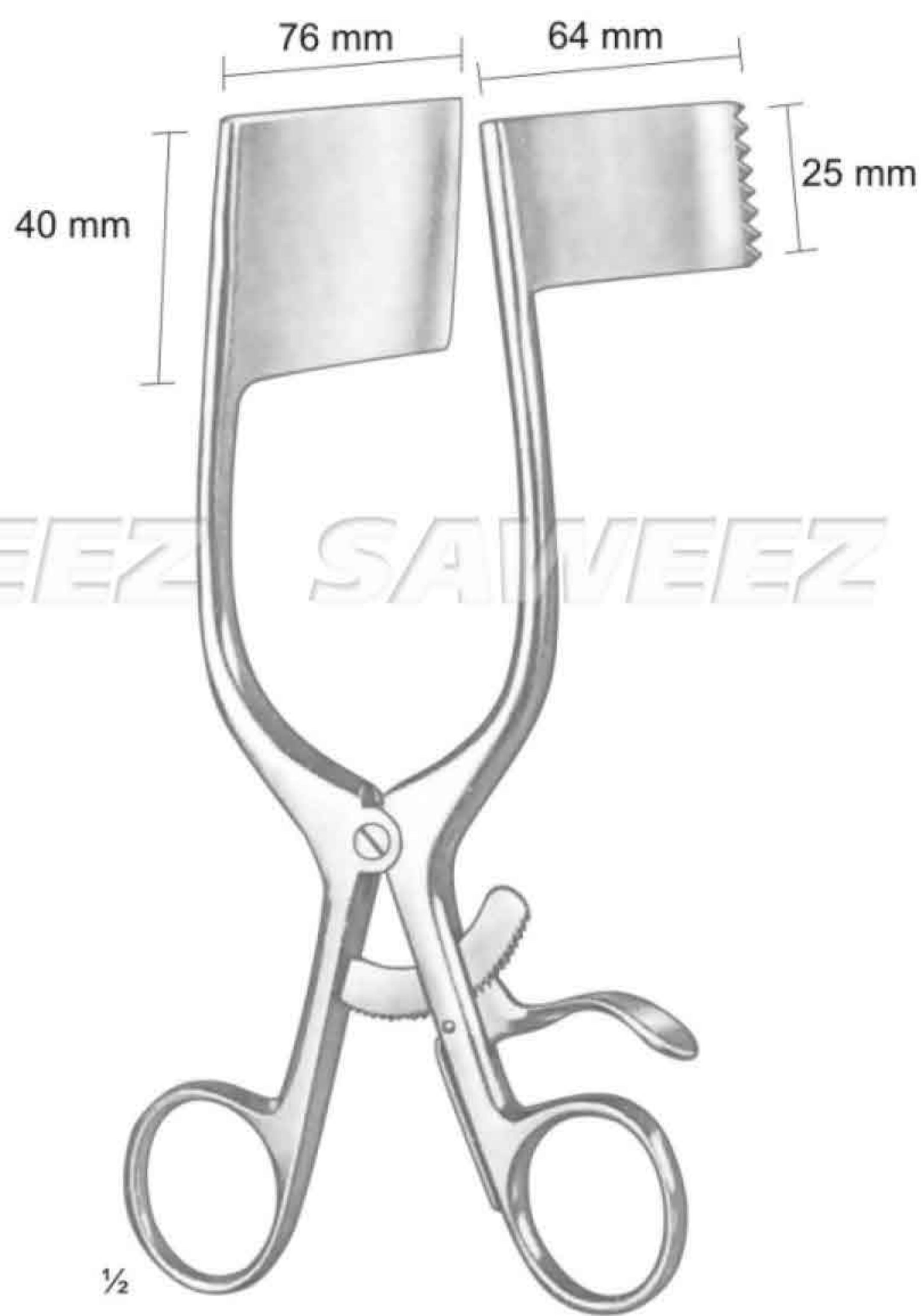


SAWEEZ SAWEEZ SAWEEZ SAWEEZ

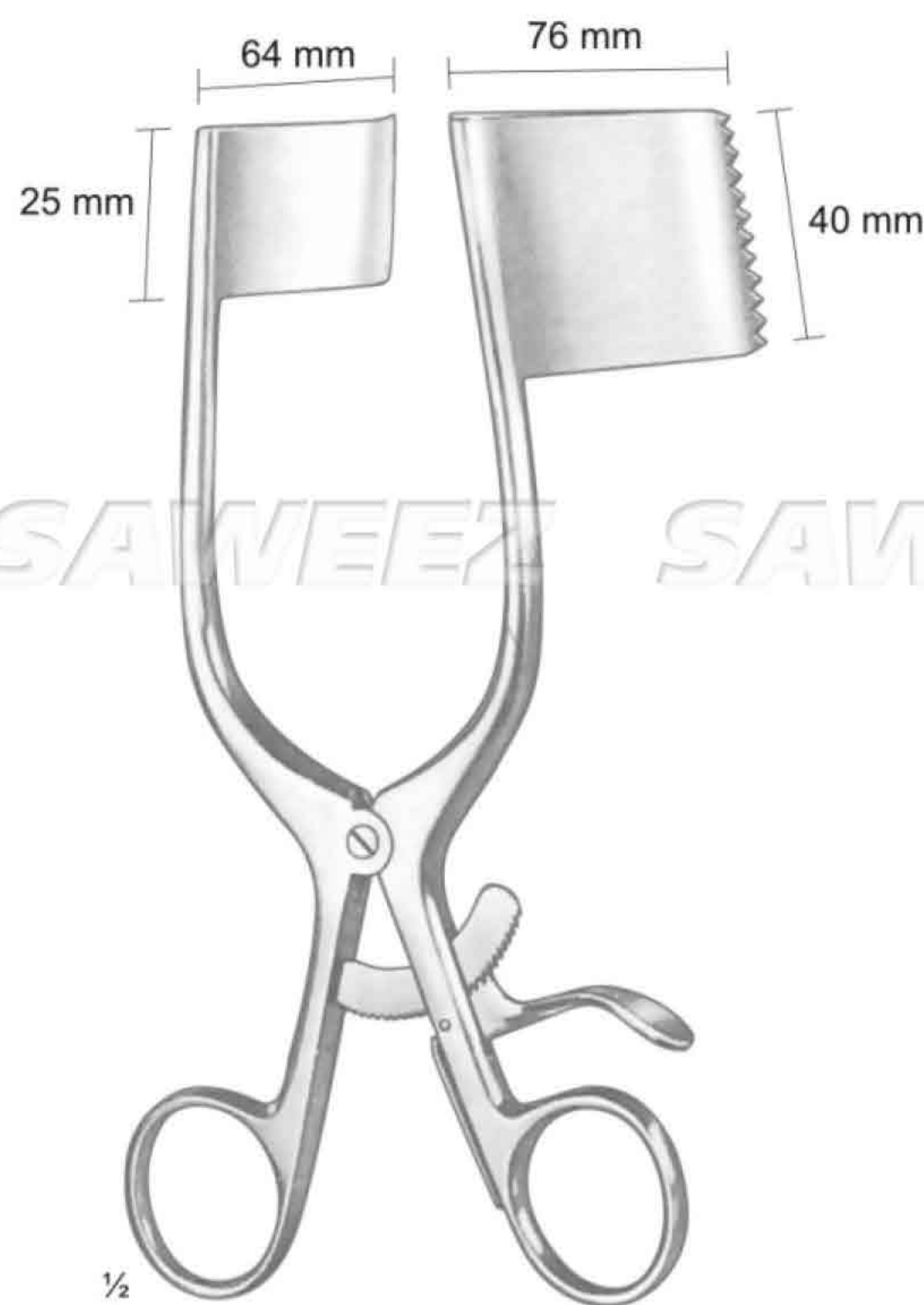
SSC-11-22-01



SAWEEZ SAWEEZ SAWEEZ SAWEEZ

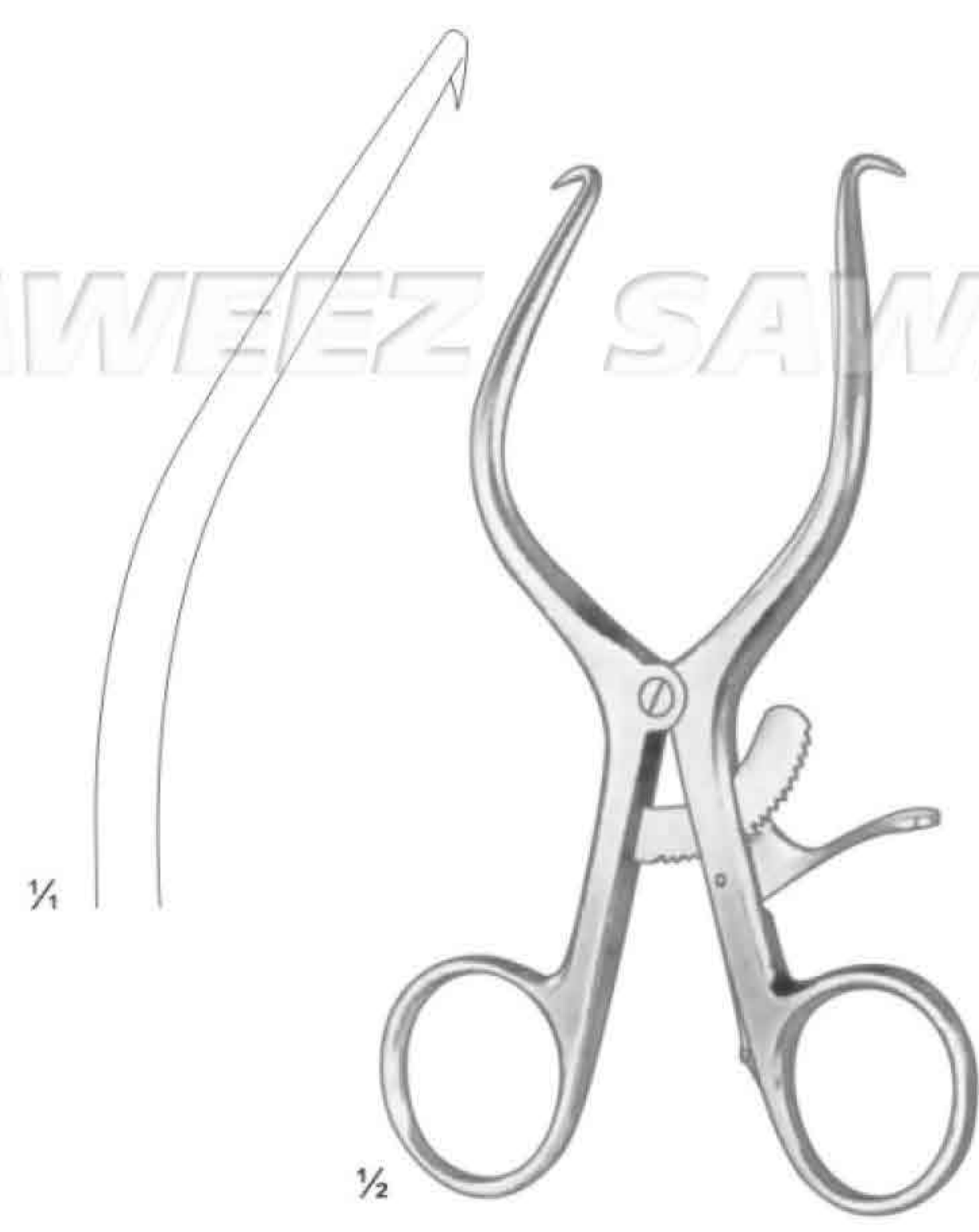


Darling
 SSC-11-22-02
 18.0 cm / 7"
 (Poplitea)

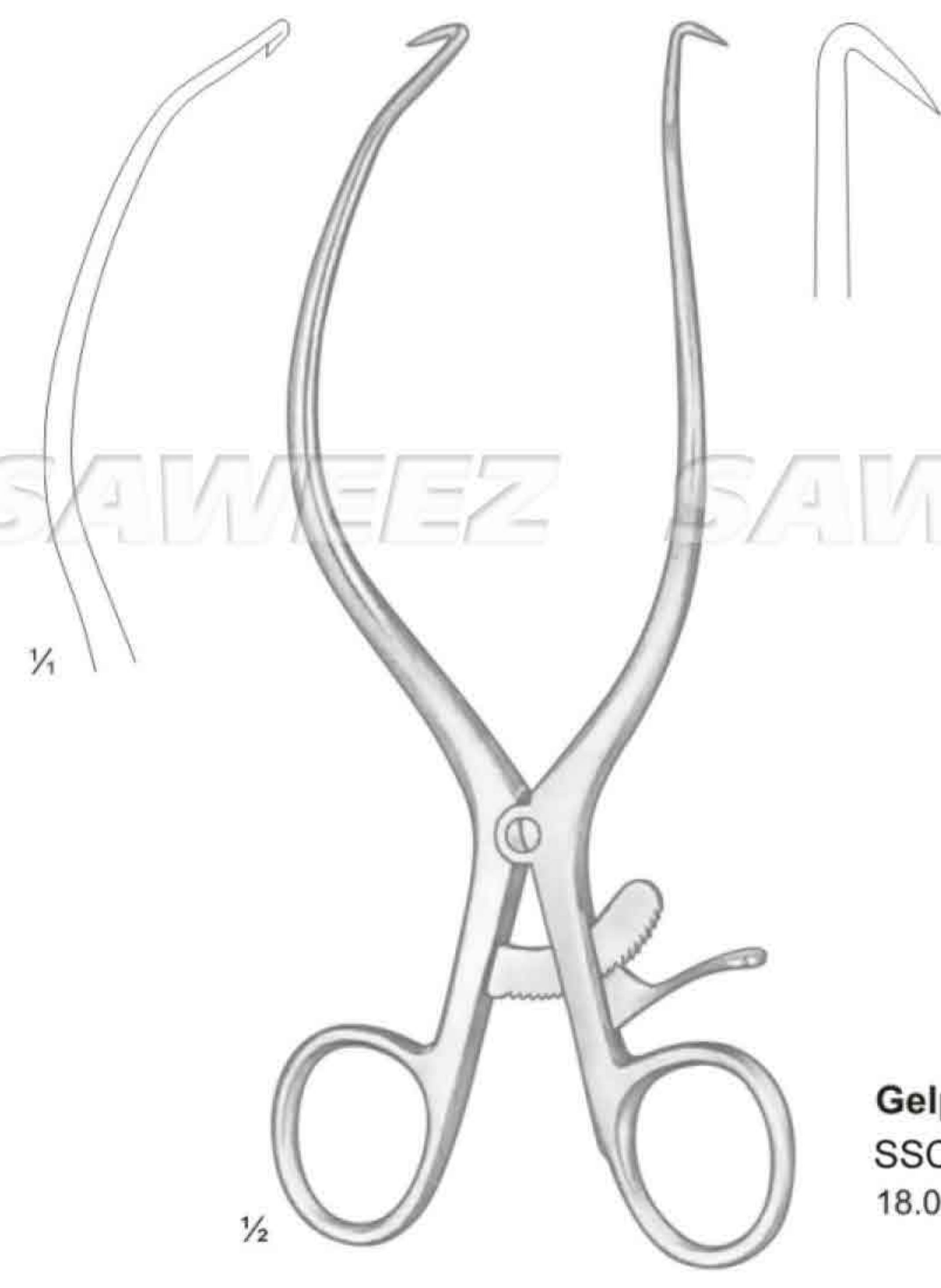


Darling
 SSC-11-22-03
 18.0 cm / 7"
 (Poplitea)

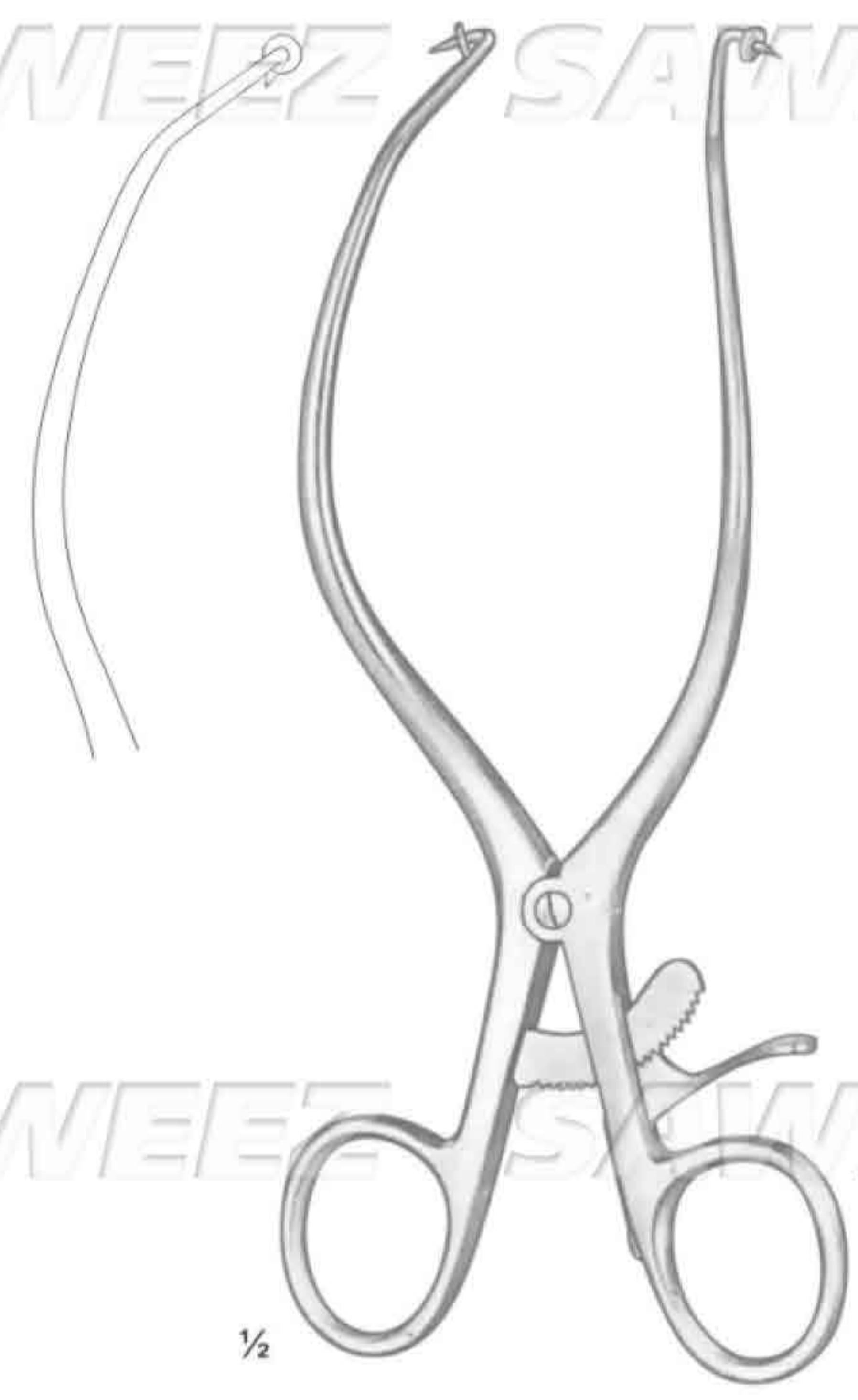
SAWEEZ SAWEEZ SAWEEZ SAWEEZ



Gelpi-Loktite
SSC-11-22-04
13.0 cm / 5"



Gelpi-Loktite
SSC-11-22-05
18.0 cm / 7"



Gelpi-Loktite
SSC-11-22-06
18.0 cm / 7"



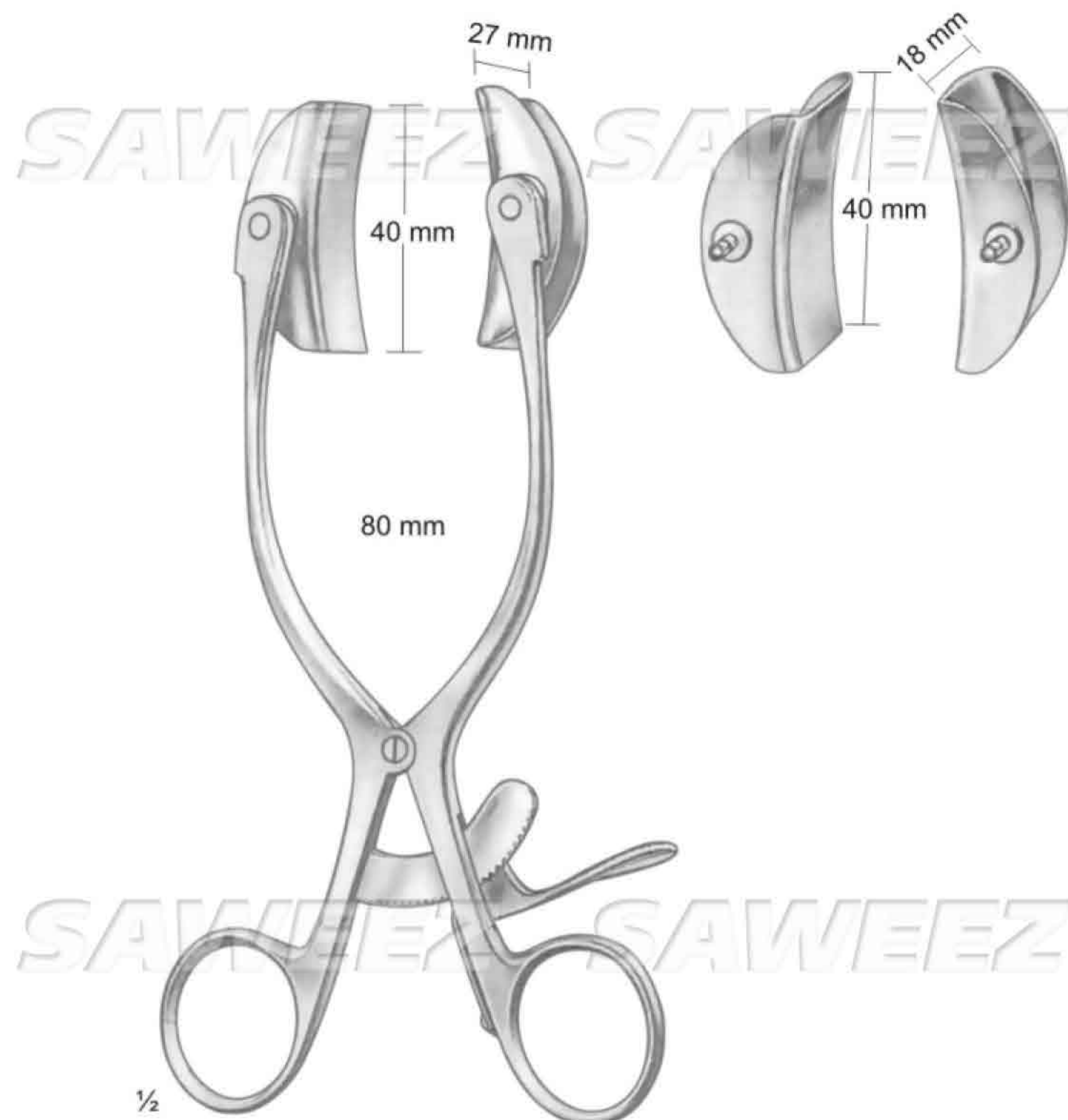
Gelpi-Seiletz
SSC-11-22-07
15.0 cm / 6"



SAWEEZ SAWEEZ SAWEEZ SAWEEZ

EXCHANGEABLE BLADES

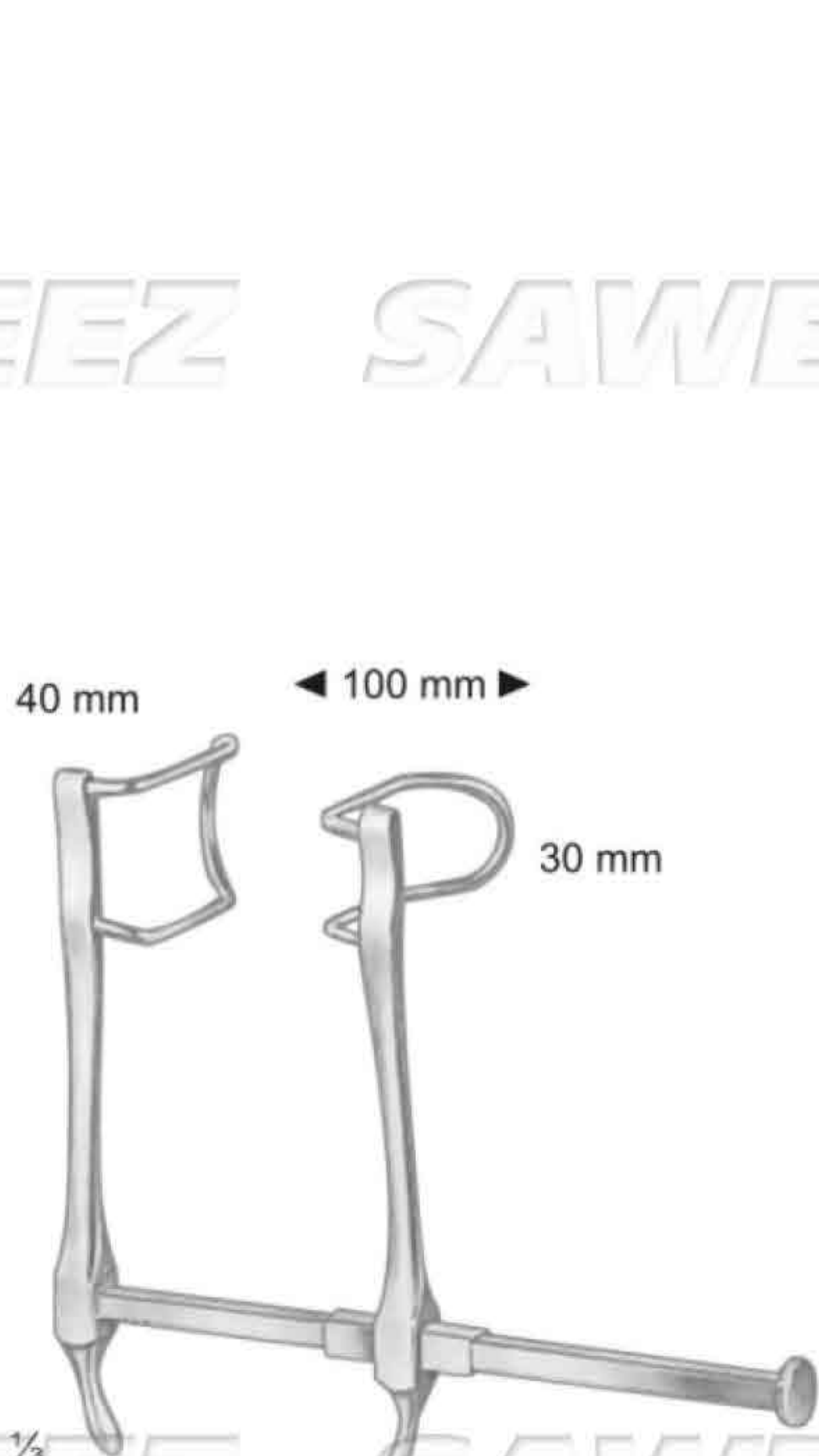
Measurements of blades: Depth x width



Baby-Collin
SSC-11-22-08
complete, with 2 pairs of blades



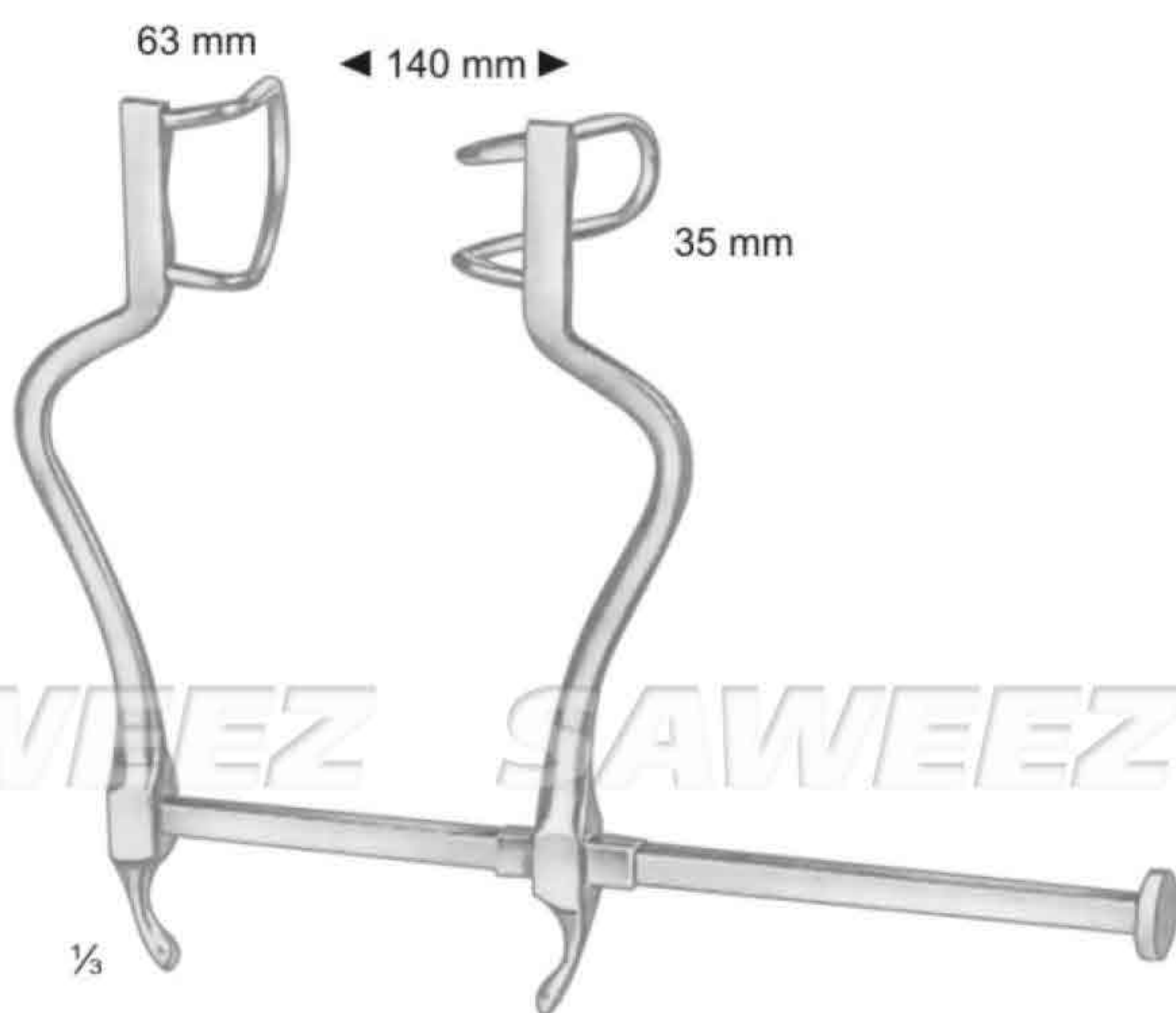
Collin
SSC-11-22-09
complete, with 1 pairs of blades 38 x 60 mm



Gosset
SSC-11-22-10



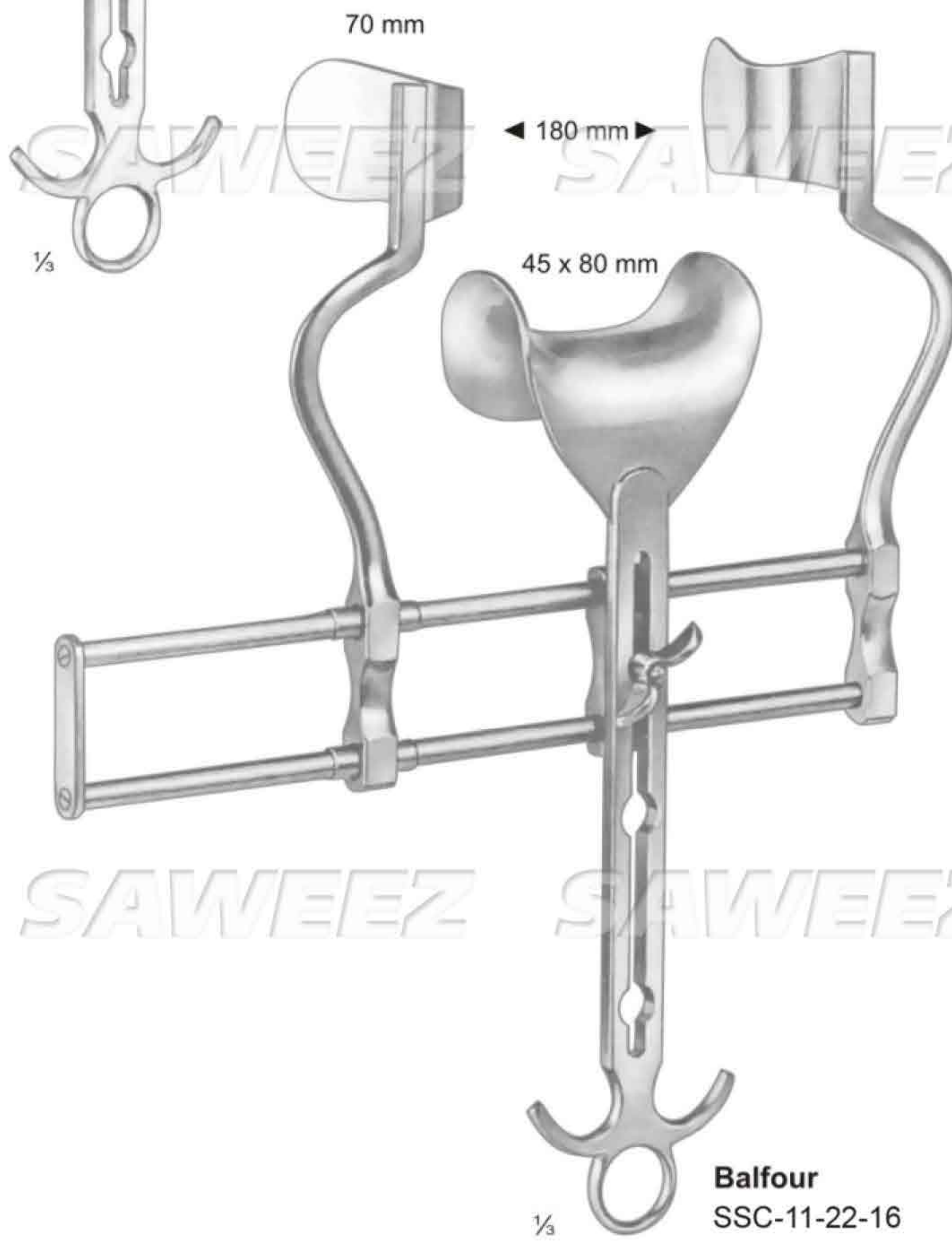
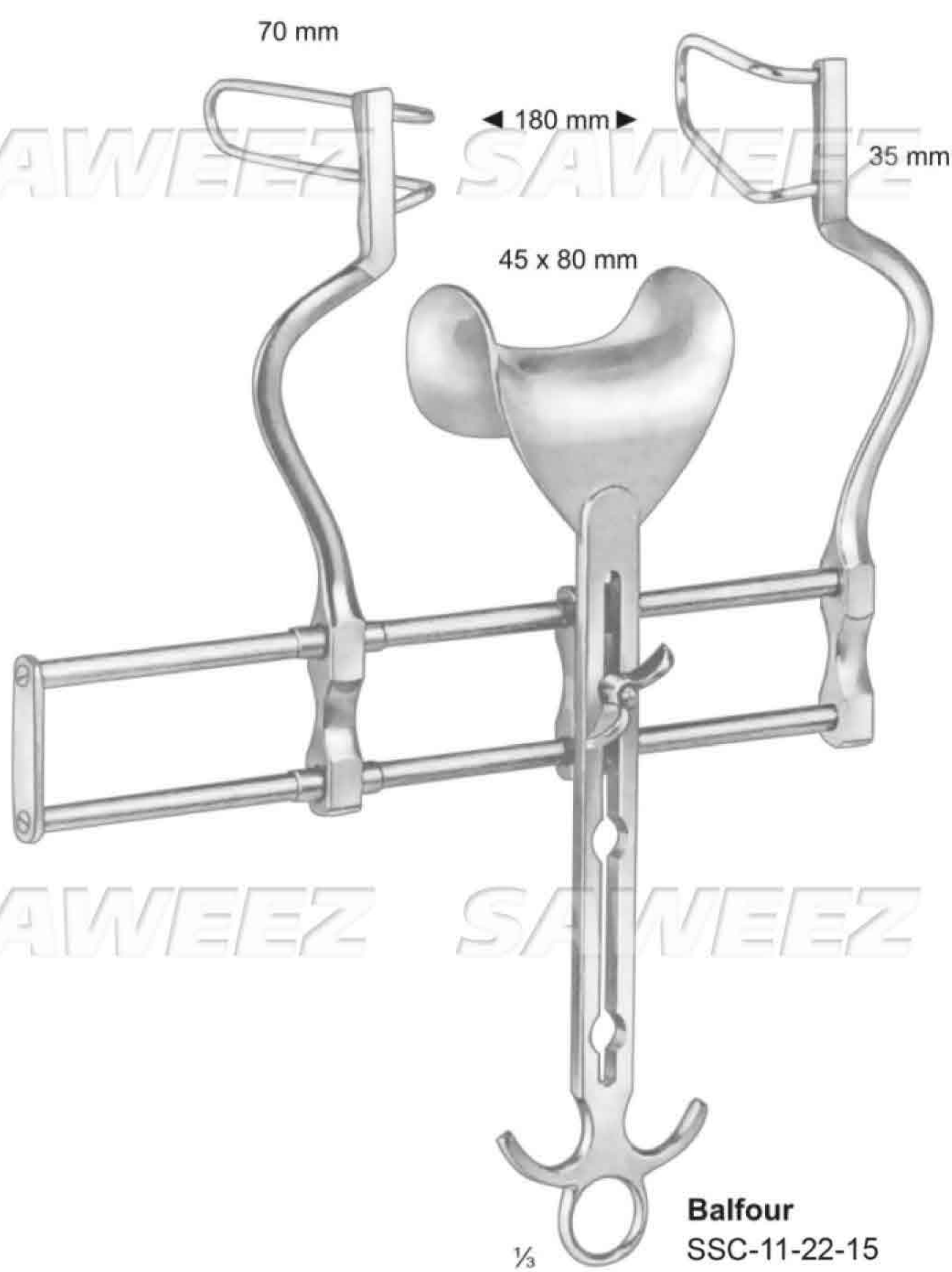
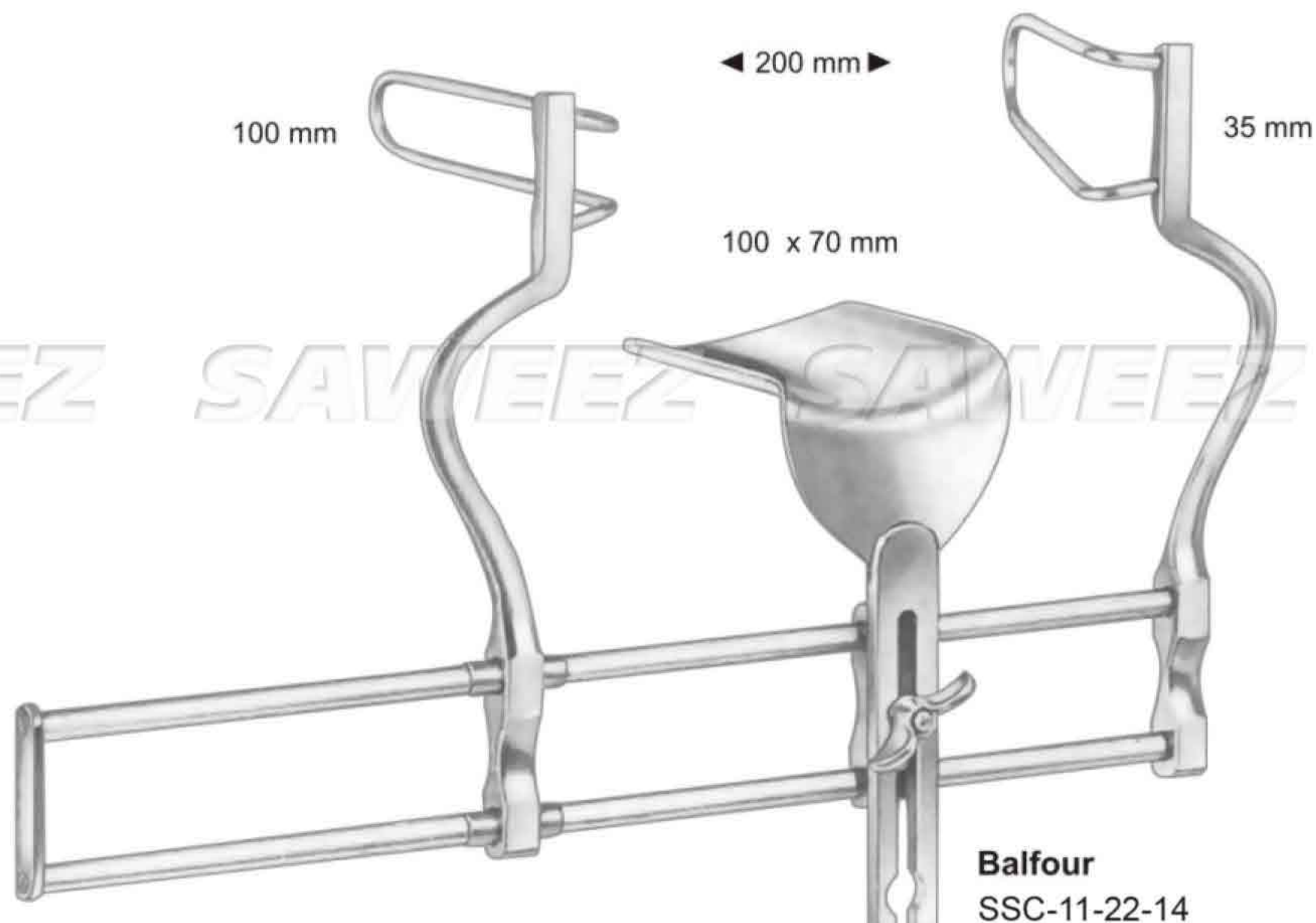
Gosset
SSC-11-22-11

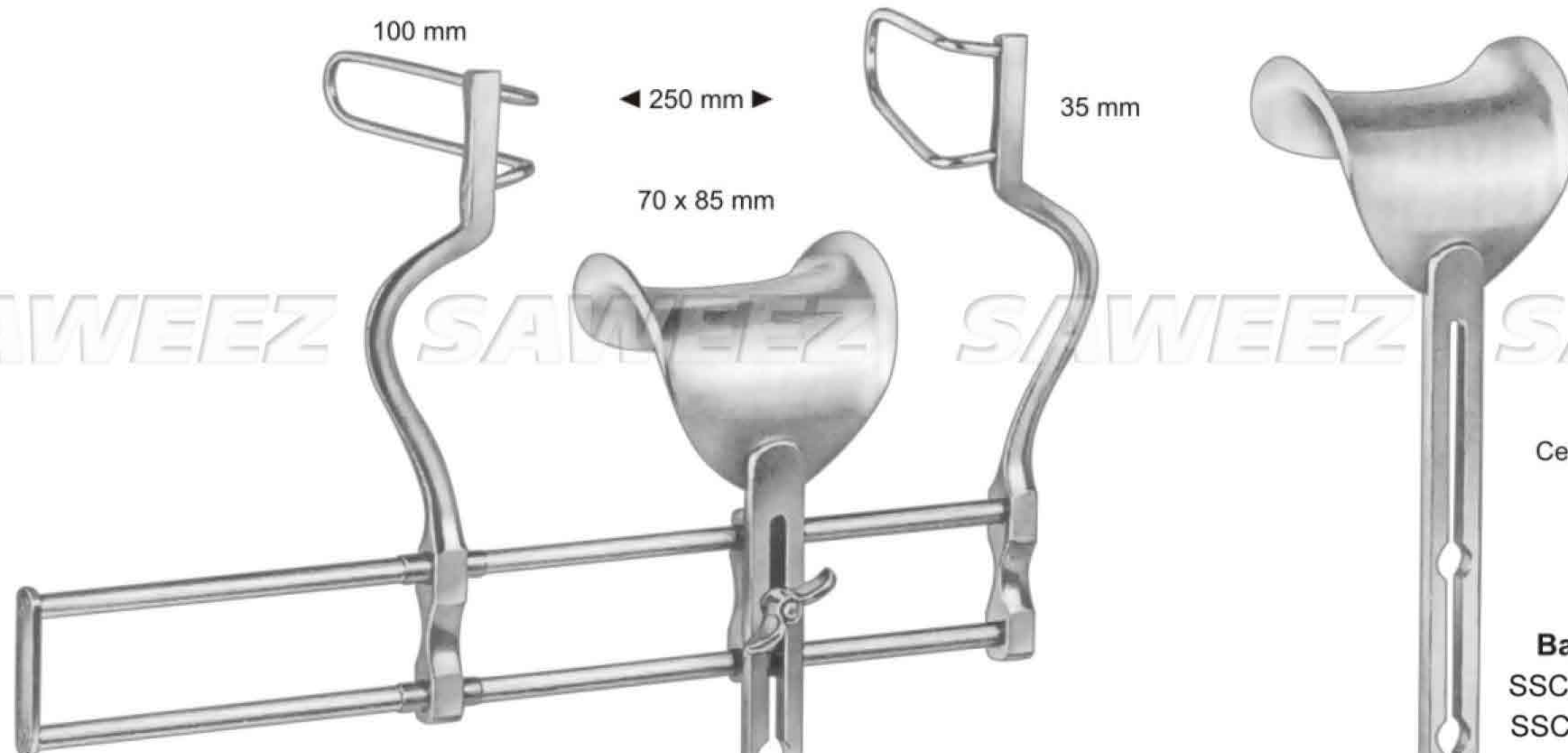


Gosset
SSC-11-22-12



Baby-Balfour
SSC-11-22-13





Balfour
SSC-11-22-17

Centre Blade Only

Balfour
SSC-11-22-18 45 x 80 mm
SSC-11-22-19 70 x 85 mm

1/3

1/3



2 x



O'Sullivan-O'Connor
SSC-11-22-20



SAWEEZ SAWEEZ SAWEEZ SAWEEZ



Reverdin
SSC-11-22-21 33.0 cm / 13", 30 mm
28.0 cm / 11"



Ribbon
SSC-11-22-22 33.0 cm / 13", 30 mm
SSC-11-22-23 33.0 cm / 13", 40 mm
SSC-11-22-24 33.0 cm / 13", 50 mm



Haberer
SSC-11-22-25 20.0 cm / 8", 18/25 mm
SSC-11-22-26 28.0 cm / 11", 25/30 mm
SSC-11-22-27 30.0 cm / 12", 45 mm



Special Model Soft
SSC-11-22-28 20.0 cm x 12mm
SSC-11-22-29 20.0 cm x 17 mm
SSC-11-22-30 25.0 cm x 25 mm

SAWEEZ SAWEEZ SAWEEZ SAWEEZ

SAWEEZ flexible SAWEEZ flexibles SAWEEZ malleable and very soft SAWEEZ

SSC-11-22-31 20.0 cm x 6,5 mm
SSC-11-22-32 20.0 cm x 9,5 mm
SSC-11-22-33 20.0 cm x 13 mm
SSC-11-22-34 20.0 cm x 16 mm
SSC-11-22-35 20.0 cm x 19 mm
SSC-11-22-36 20.0 cm x 25 mm



SAWEEZ SAWEEZ SAWEEZ SAWEEZ



Rabiner
SSC-13-11-11
23.0 cm / 9"
40 mm ø



Buck
SSC-13-11-12
18.0 cm / 7"



telescopic

Buck
SSC-13-11-13
18.0 cm / 7"

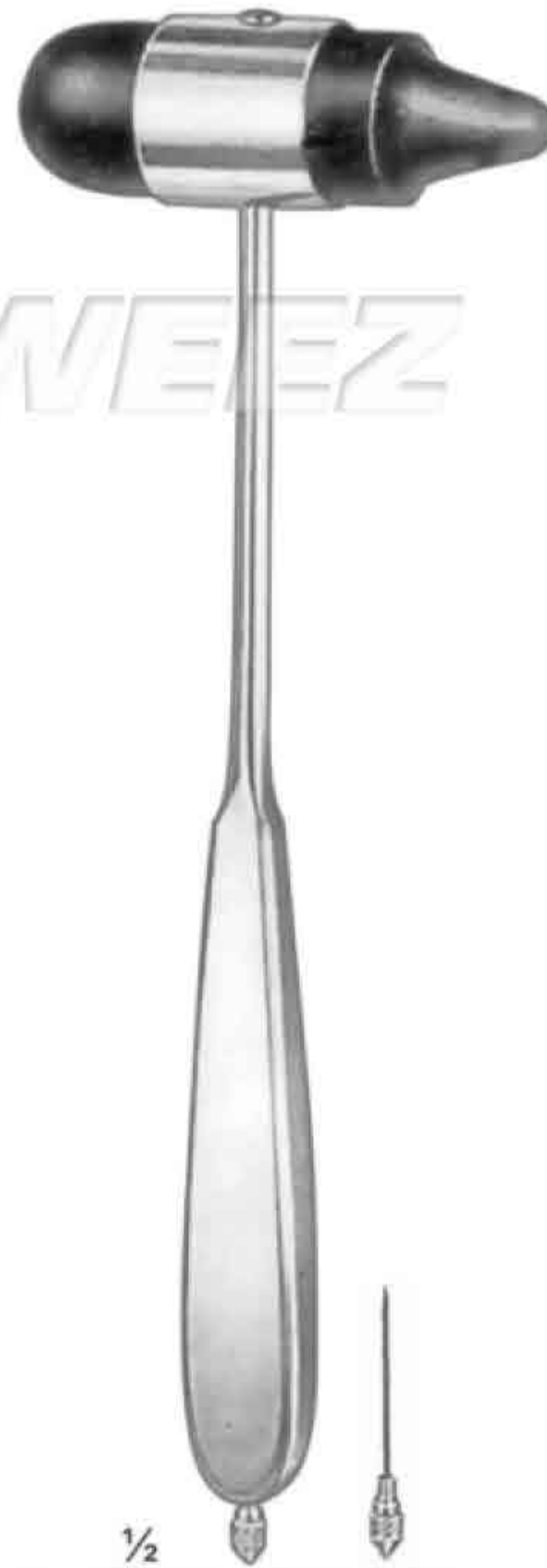


Special-Mobile
SSC-13-11-14
19.0 cm / 7½"

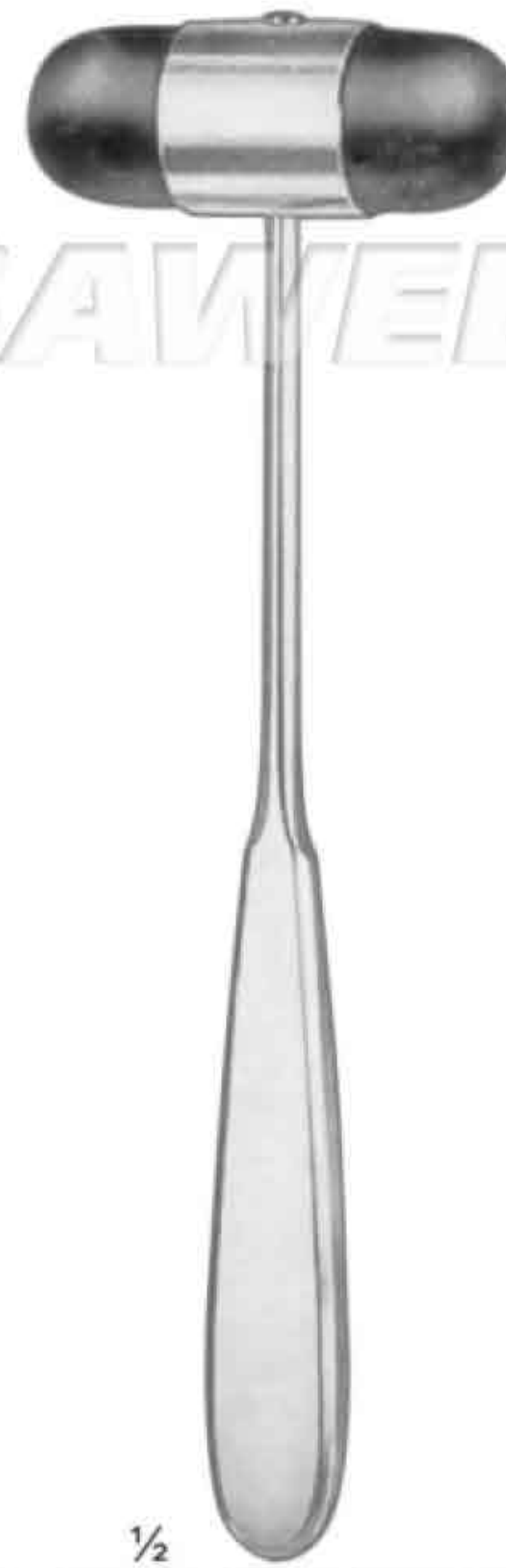
SAWEEZ SAWEEZ SAWEEZ SAWEEZ



1/2
Troemner
BI-153-1145
24.0 cm / 9 1/2"



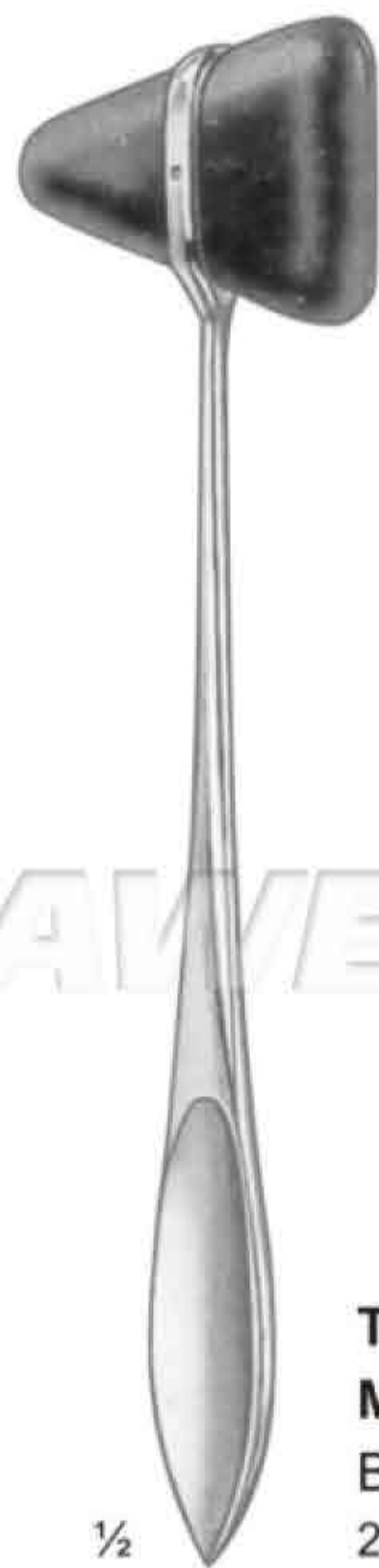
1/2
**Neuro-Duoflex
Mod. Dejerine**
BI-153-1146
22.0 cm / 8 1/4"



1/2
Dejerine
BI-153-1147
20.0 cm / 8"



1/2
Dejerine
BI-153-1148
21.0 cm / 8 1/4"



1/2
**Taylor
Mod. USA**
BI-153-1149
20.0 cm / 8"



1/2
Berliner
BI-153-1150
20.0 cm / 8"



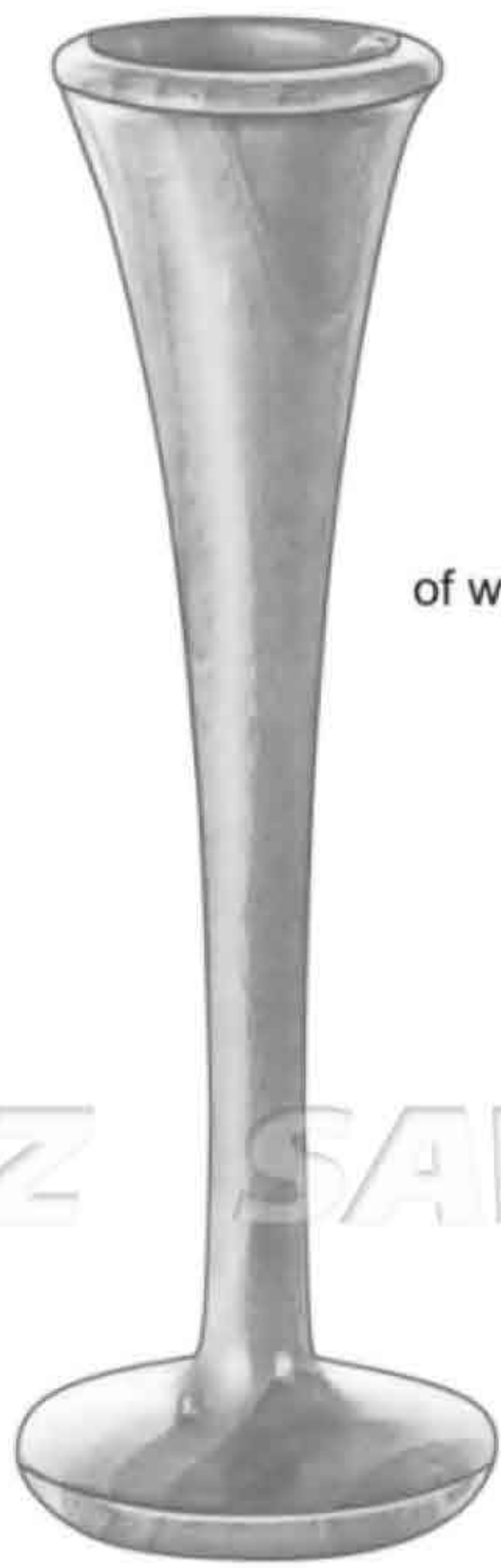
Aly
SSC-13-11-21
17.0 cm / 6¾"



Wartenberg
SSC-13-11-22
19.0 cm / 7½"



Weber
SSC-13-11-23
9.0 cm / 3½"



of wood

½

Pinard
SSC-13-11-24
18.0 cm / 7"



of aluminium

½

Pinard
SSC-13-11-25
15.0 cm / 6"



1/2

Universal
SSC-15-11-11
Set of 3 Pieces

SSC-15-11-12
Set of 4 Pieces



1/2

Standard
11.0 cm / 4 1/2"
SSC-15-11-13 = 3 mm ø
SSC-15-11-14 = 4 mm ø
SSC-15-11-15 = 5 mm ø
SSC-15-11-16 = 6 mm ø



1/2

Standard
12.0 cm / 4 3/4"
SSC-15-11-17 = 3 mm ø
SSC-15-11-18 = 4 mm ø
SSC-15-11-19 = 5 mm ø
SSC-15-11-20 = 6 mm ø



1/2

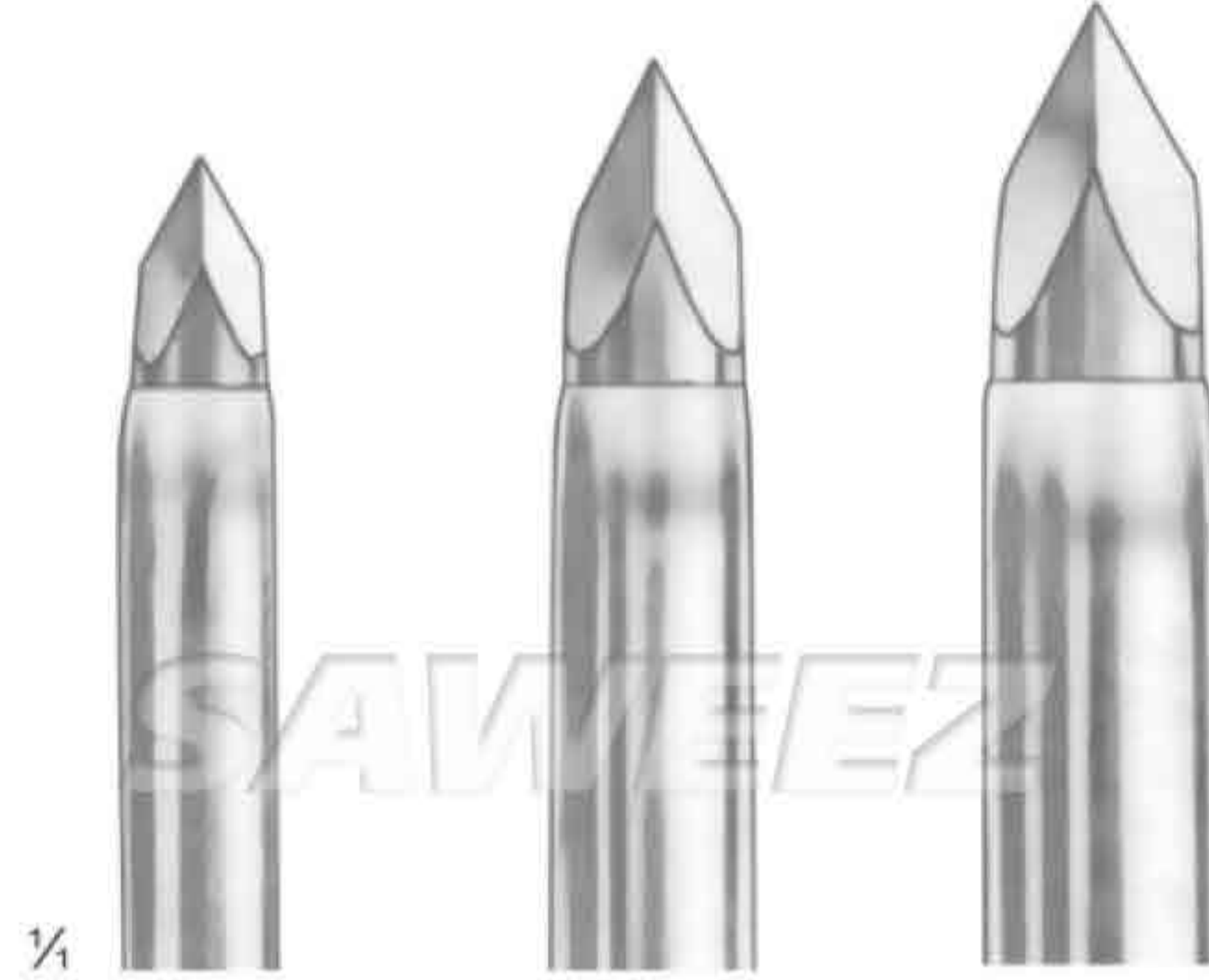
Standard
12.0 cm / 4 3/4"
SSC-15-11-21 = 3 mm ø
SSC-15-11-22 = 4 mm ø
SSC-15-11-23 = 5 mm ø
SSC-15-11-24 = 6 mm ø



Duke
SSC-15-11-25
11.0 cm / 4½"
5.5 mm / ø



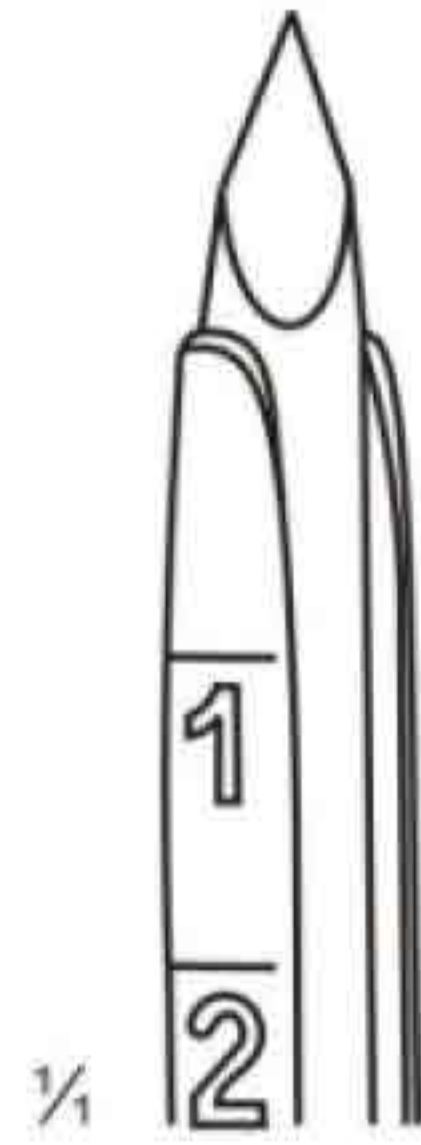
Nelson
21.0 cm / 8¼"



SSC-15-11-26 SSC-15-11-27 SSC-15-11-28



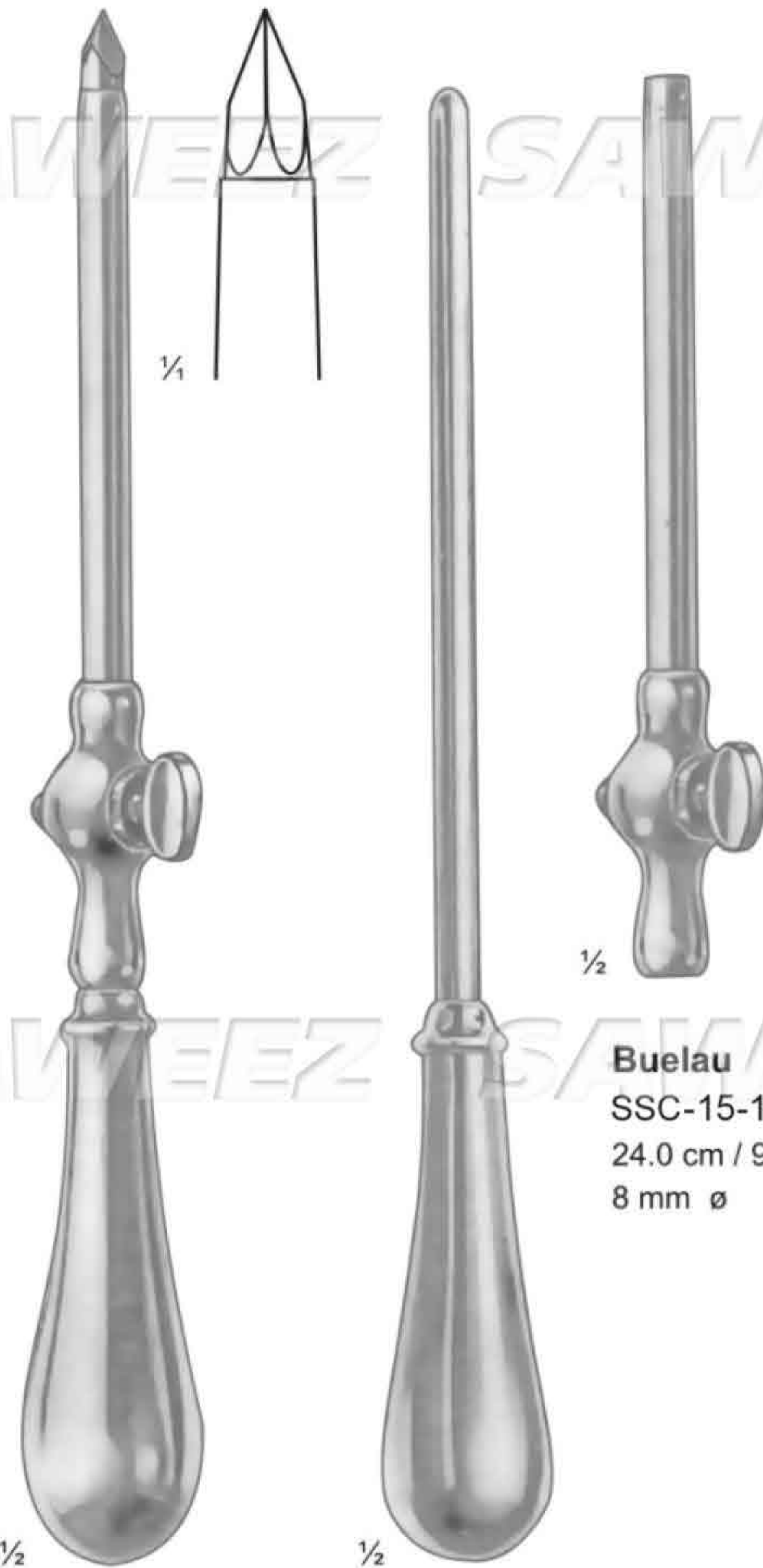
Campbell
16.0 cm / 6½"



SSC-15-11-29
6 mm / ø



SSC-15-11-30
8 mm / ø



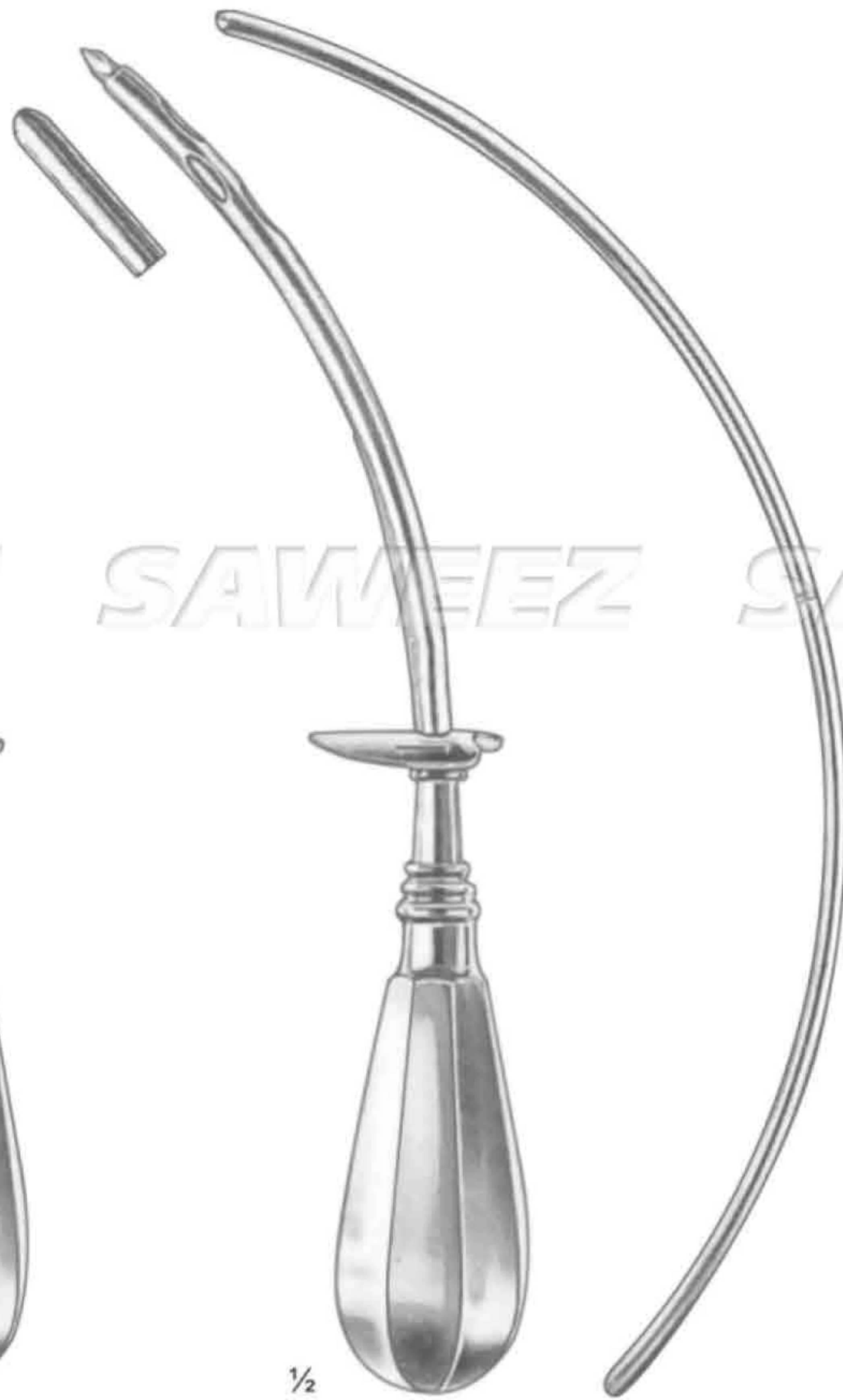
Buelau
SSC-15-11-31
24.0 cm / 9½"
8 mm ø



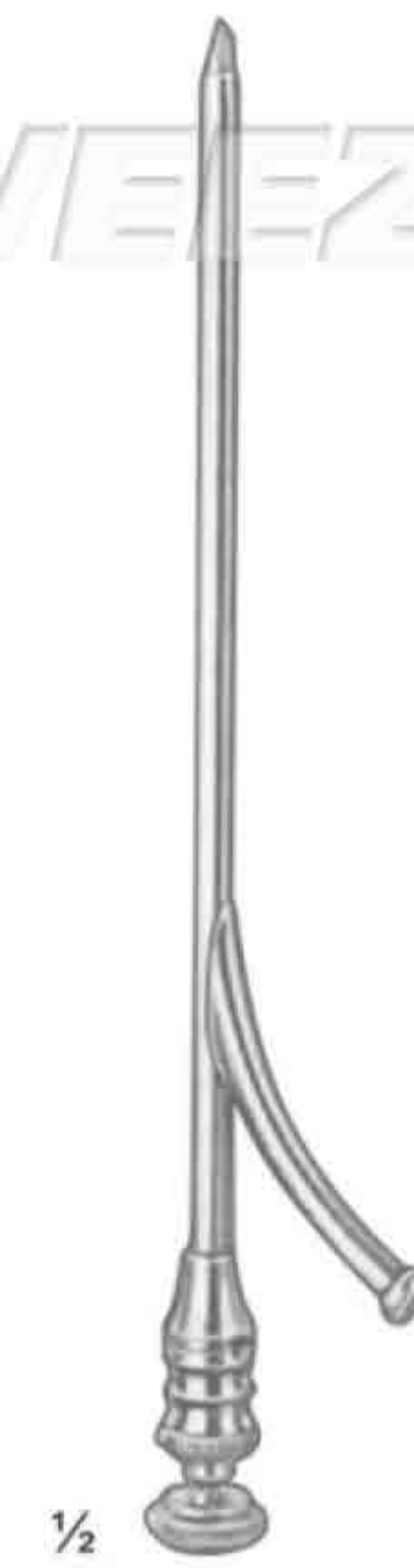
SAWEEZ SAWEEZ SAWEEZ SAWEEZ



1/2



1/2



1/2



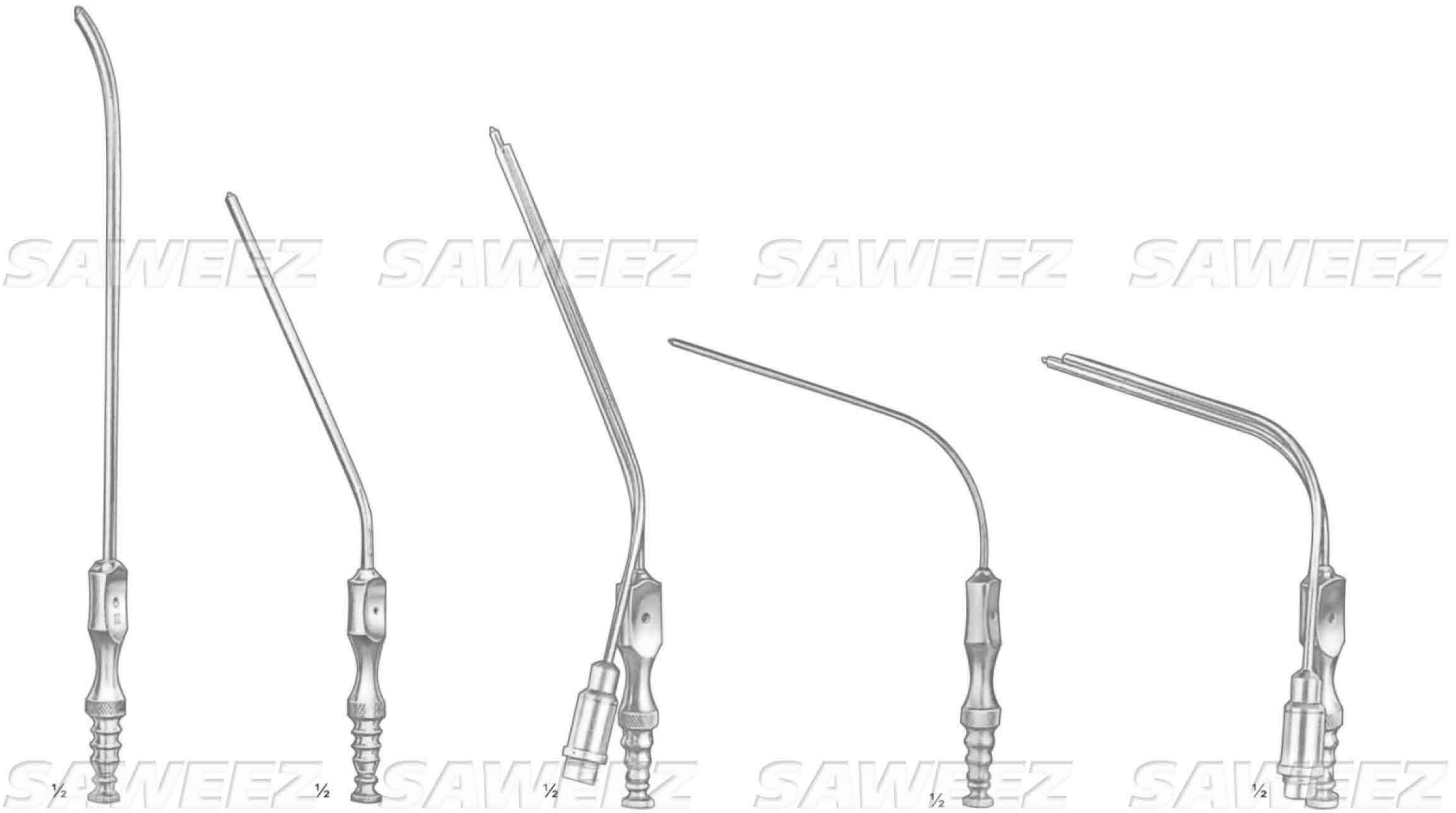
1/2

Fleurant
SSC-15-11-32
23.0 cm / 9"
5 mm ø

Fleurant
SSC-15-11-33
23.0 cm / 9"
5 mm ø

Ochsner
14.0 cm / 5 1/2"
SSC-15-11-34 = 4 mm ø
SSC-15-11-35 = 5.5 mm ø
SSC-15-11-36 = 6.5 mm ø

Billrot
SSC-15-11-37
24.0 cm / 10"
6 mm ø



Adson
SSC-15-11-38
4 mm ø
21.0 cm / 18 1/4"

Frazier
SSC-15-11-39, SSC-15-11-42
19.0 cm / 7 1/2"
Fr.
6 SSC-15-11-39
8 SSC-15-11-40
10 SSC-15-11-41
12 SSC-15-11-42

Frazier
SSC-15-11-43, SSC-15-11-44
19.0 cm / 7 1/2"
Fr.
8 SSC-15-11-43
10 SSC-15-11-44

Poppen
SSC-15-11-45, SSC-15-11-48
13.0 cm / 5"
Fr.
6 SSC-15-11-45
8 SSC-15-11-46
10 SSC-15-11-47
12 SSC-15-11-48

Poppen
SSC-15-11-49, SSC-15-11-50
13.0 cm / 5"
Fr.
8 SSC-15-11-49
10 SSC-15-11-50



Wullstein
SSC-15-11-51
14.0 cm / 5 1/2"



SSC-15-11-52



SSC-15-11-53



SSC-15-11-54

SSC-15-11-43, SSC-15-11-44 - with Fiber Optics
SSC-15-11-49, SSC-15-11-50 - with Fiber Optics

SSC-15-11-51 - with Micro suction tube, complete
consisting of:

SSC-15-11-52 - micro suction cannula, ø 0.4 mm
SSC-15-11-53 - ditto ø 0.6 mm
SSC-15-11-54 - ditto ø 0.8 mm



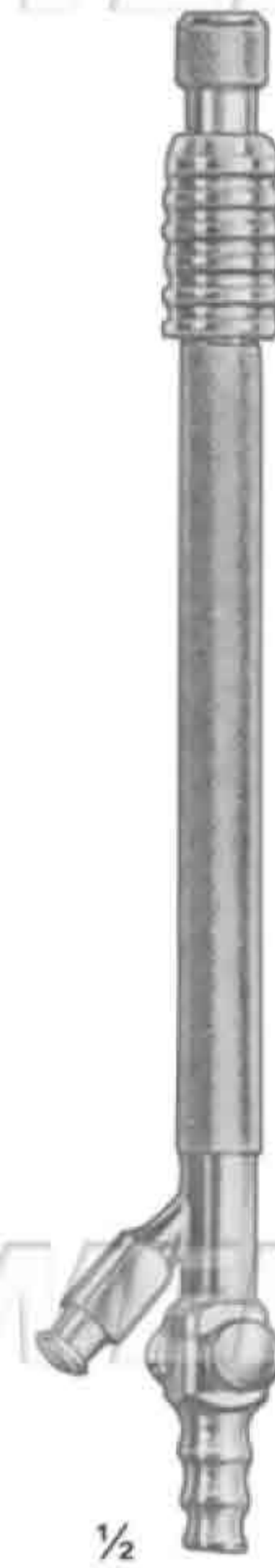
SAWEEZ SAWEEZ SAWEEZ SAWEEZ



Gomel
SSC-15-11-55
15.0 cm / 6"



Hepp/Scheidel
SSC-15-11-56
22.5 cm / 9"

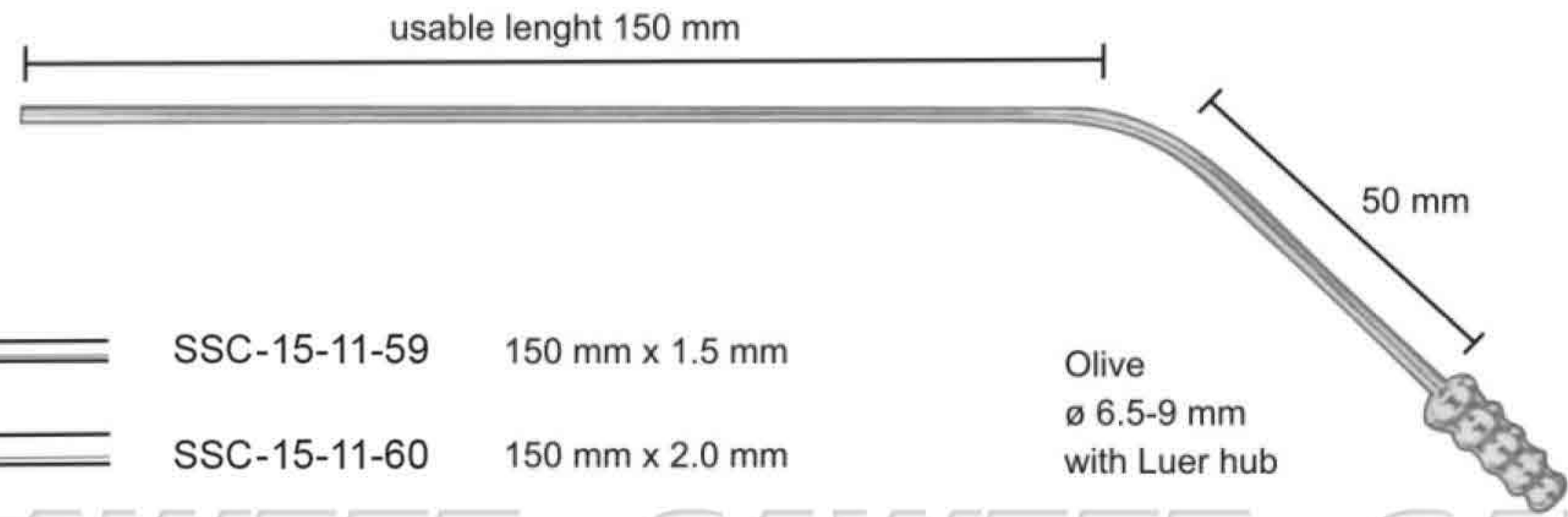


SSC-15-11-57
16.0 cm / 6¼"



SSC-15-11-58
6.5 cm / 2½"

SAWEEZ SAWEEZ SAWEEZ SAWEEZ



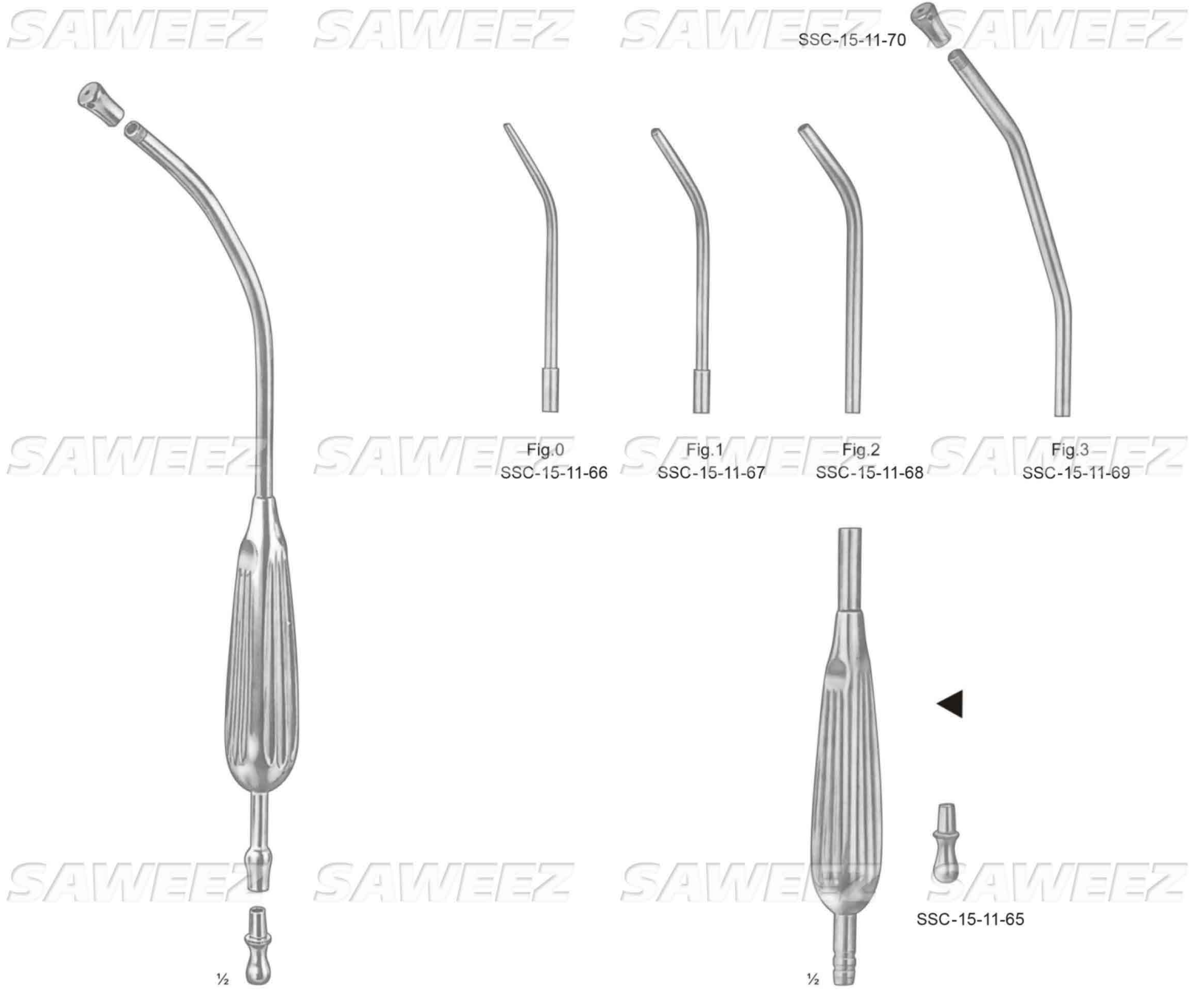
- SSC-15-11-59 150 mm x 1.5 mm
- SSC-15-11-60 150 mm x 2.0 mm
- SSC-15-11-61 150 mm x 2.5 mm
- SSC-15-11-62 150 mm x 3.5 mm

Olive
ø 6.5-9 mm
with Luer hub

Yasargil
11.0 cm / 4¼"

SAWEEZ SAWEEZ SAWEEZ SAWEEZ

Irrigator for Microsurgery
Irrigator/Aspirator complete with cannula
Irrigator/Aspirator only
Suction and Irrigation, cannula only



Yankauer
 SSC-15-11-63
 27.0 cm / 11"

Yankauer
 SSC-15-11-64
 27.0 cm / 11"
 Fig. 0-3



Poole
SSC-15-11-71
22.0 cm / 8¾", 10 mm ø
(Fr.30)

Poole
SSC-15-11-72
22.0 cm / 8¾", 8 mm ø
(Fr.23)

Cooley
SSC-15-11-73
35.0 cm / 14"

Cooley
SSC-15-11-74
31.0 cm / 12½"

Cooley
SSC-15-11-75
30.0 cm / 12"

Cooley
SSC-15-11-76
33.0 cm / 13¼"



6 mm round

6 mm oval



Nuboer
SSC-15-11-77
21.0 cm / 8¼"

Nuboer
SSC-15-11-78
21.0 cm / 8¼"



Coupland
SSC-15-11-79
17.0 cm / 6¾"



- ¼ ○ SSC-15-11-80
1.5 mm ø
- SSC-15-11-81
2.0 mm ø
- SSC-15-11-82
2.5 mm ø
- SSC-15-11-83
3.5 mm ø



- ¼ ○ SSC-15-11-84
1.5 mm ø
- SSC-15-11-85
2.0 mm ø
- SSC-15-11-86
2.5 mm ø
- SSC-15-11-87
3.5 mm ø

with additional side holes

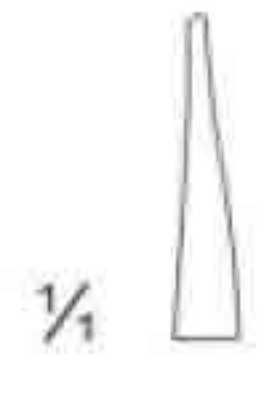


- SSC-15-11-88
1.5 mm ø
- SSC-15-11-89
2.5 mm ø
- SSC-15-11-90
3.5 mm ø

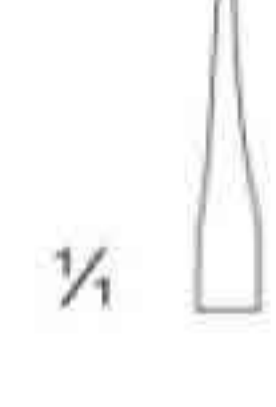
Byrd
20.0 cm / 8"



Cogoswell
SSC-15-11-91
23 cm / 9"



SSC-17-11-11 SSC-17-11-12



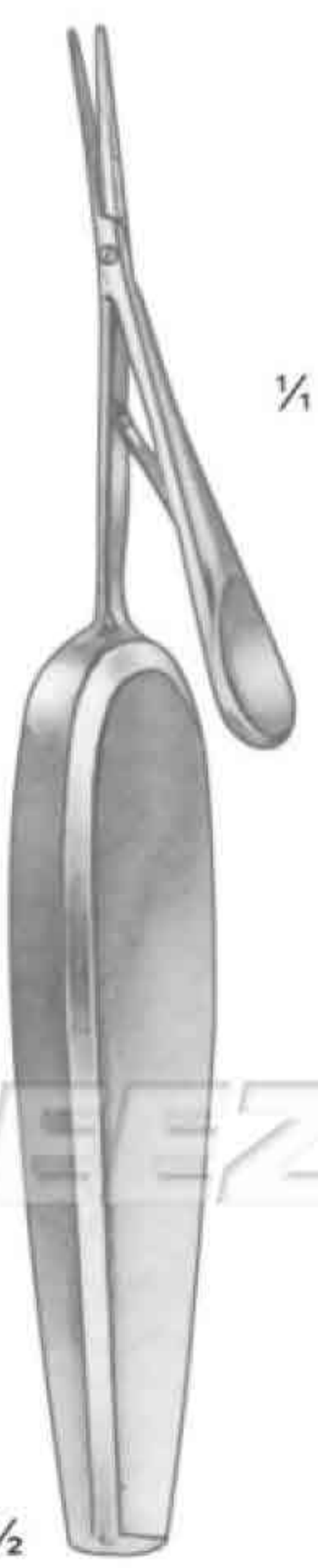
SSC-17-11-13 SSC-17-11-14

1/2

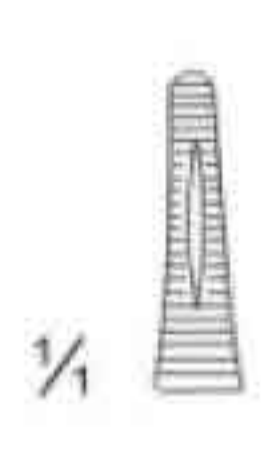
1/2

18.0 cm / 7"

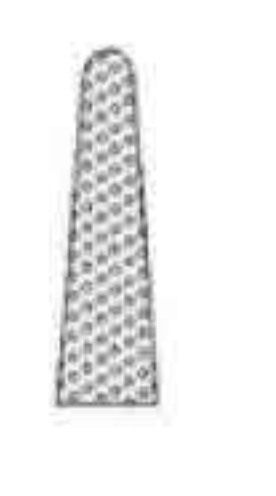
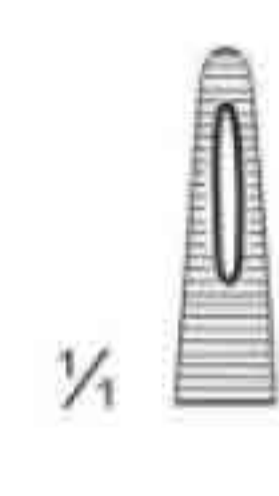
18.0 cm / 7"



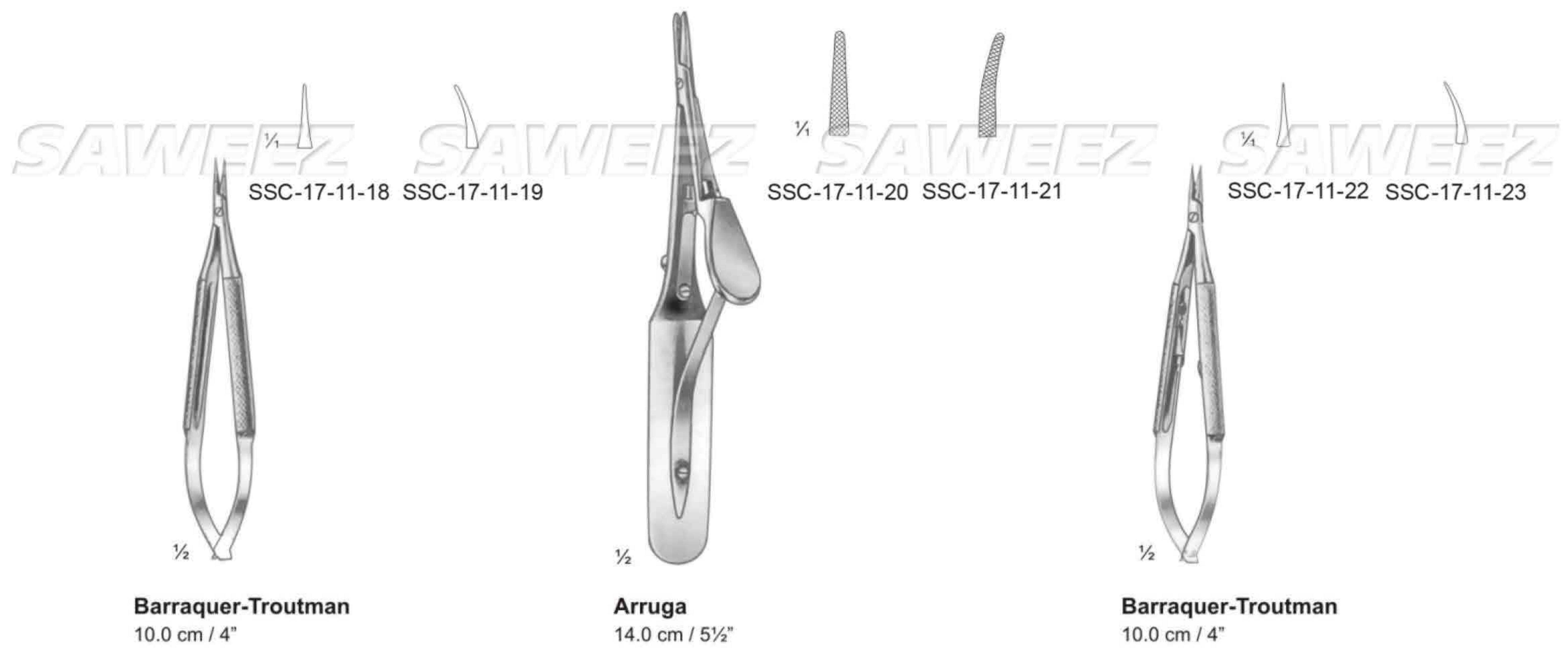
Barraquer
SSC-17-11-15
16.0 cm / 6 1/4"



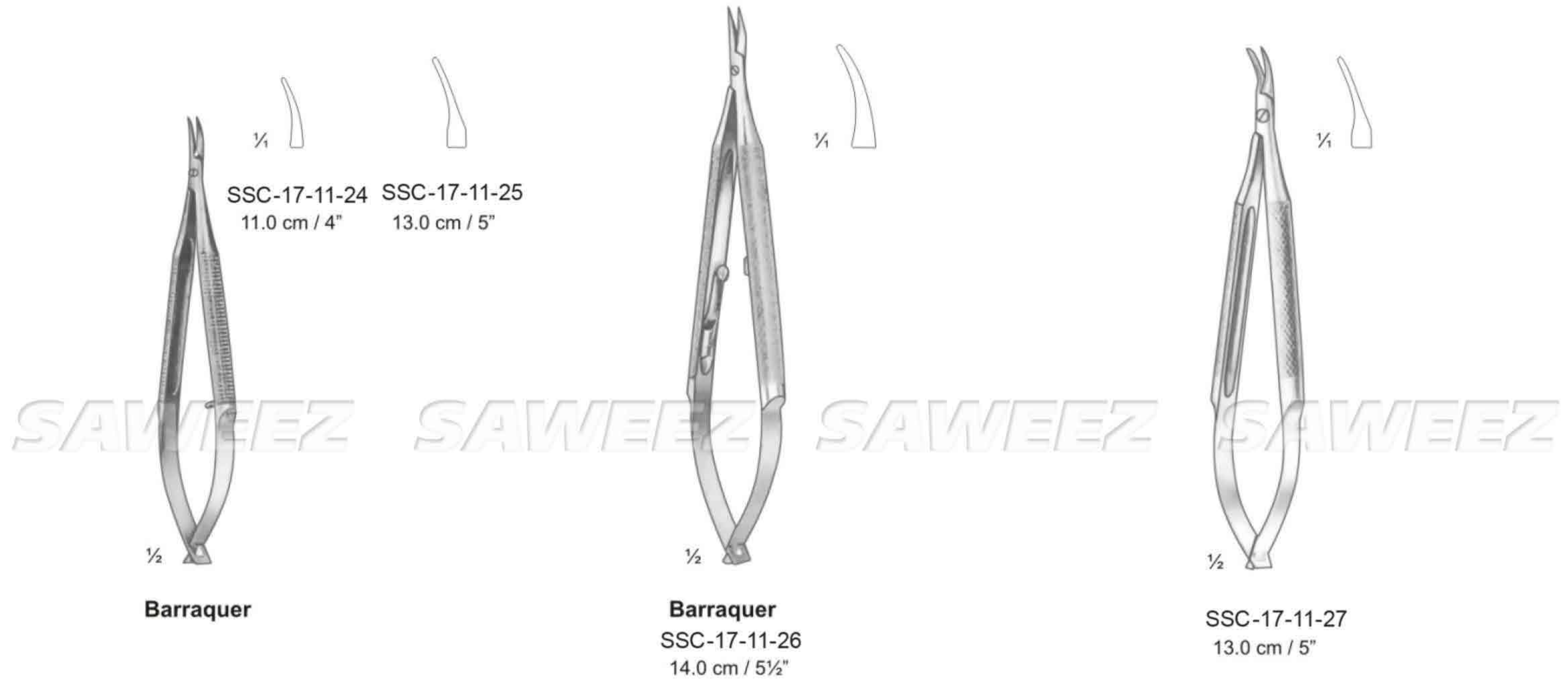
Barraquer
SSC-17-11-16
14.0 cm / 5 1/2"

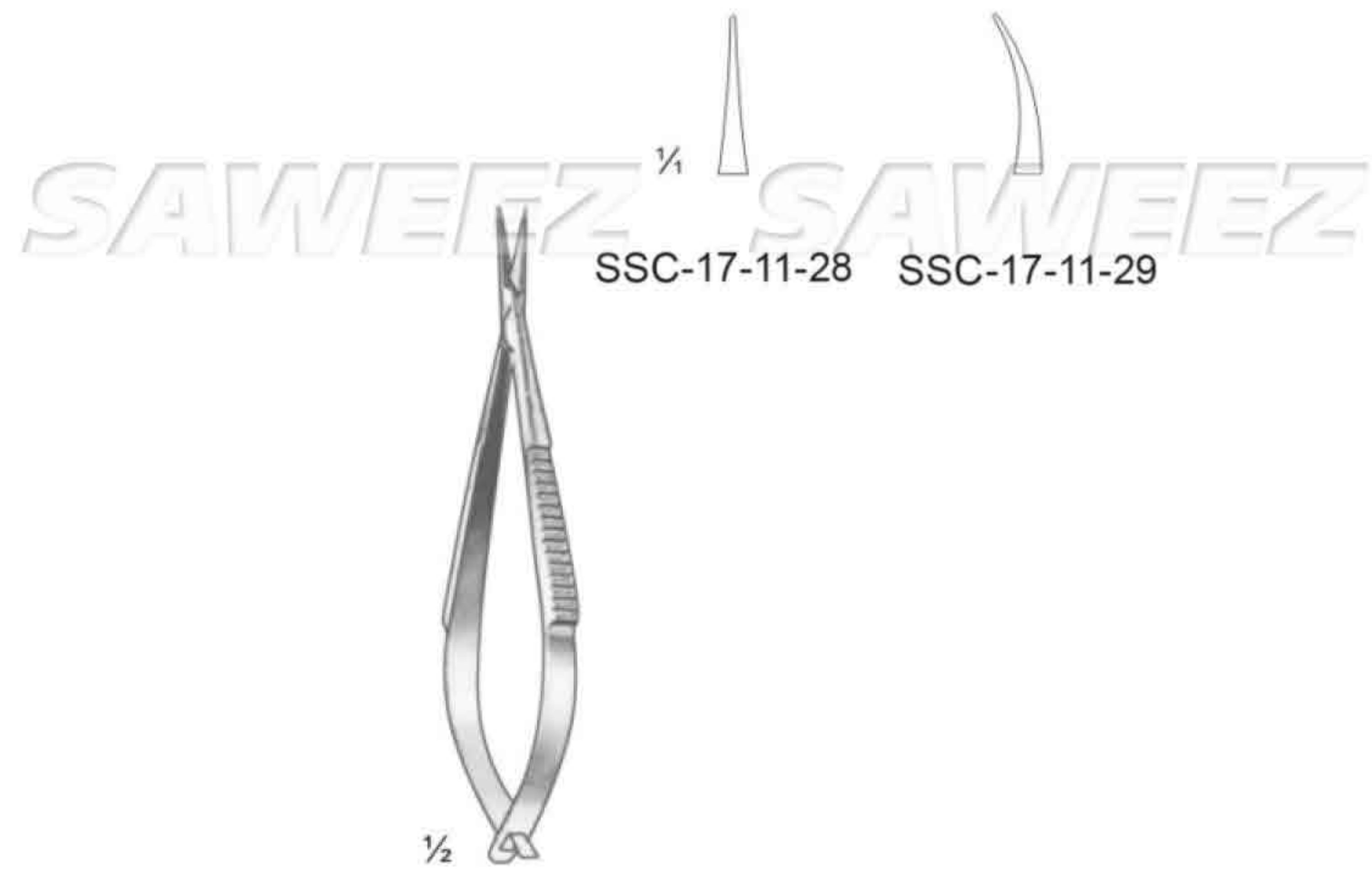


Kalt
SSC-17-11-17
14.0 cm / 5 1/2"



SAWEEZ SAWEEZ SAWEEZ SAWEEZ



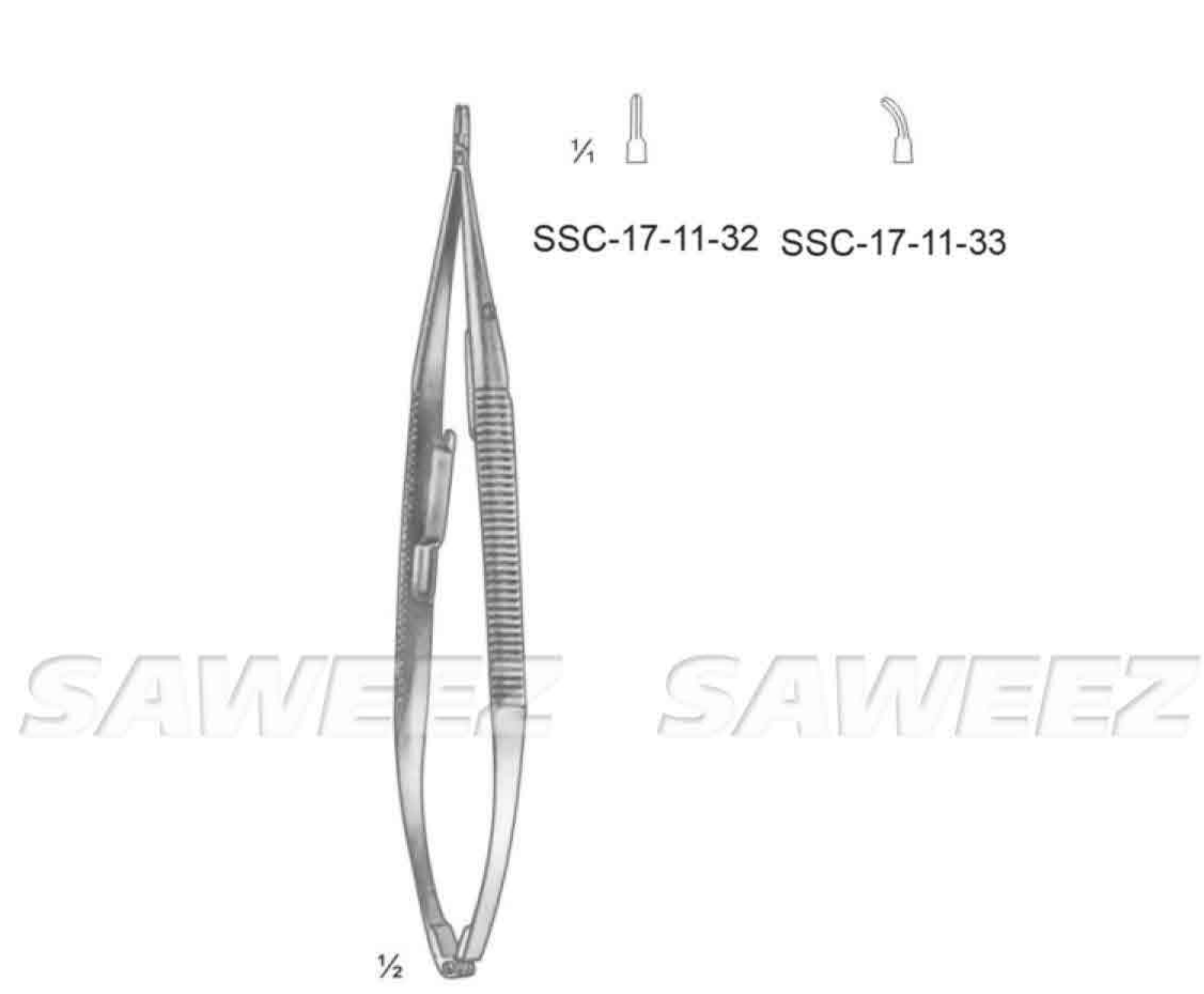


Castroviejo
9.0 cm / 3 1/2"

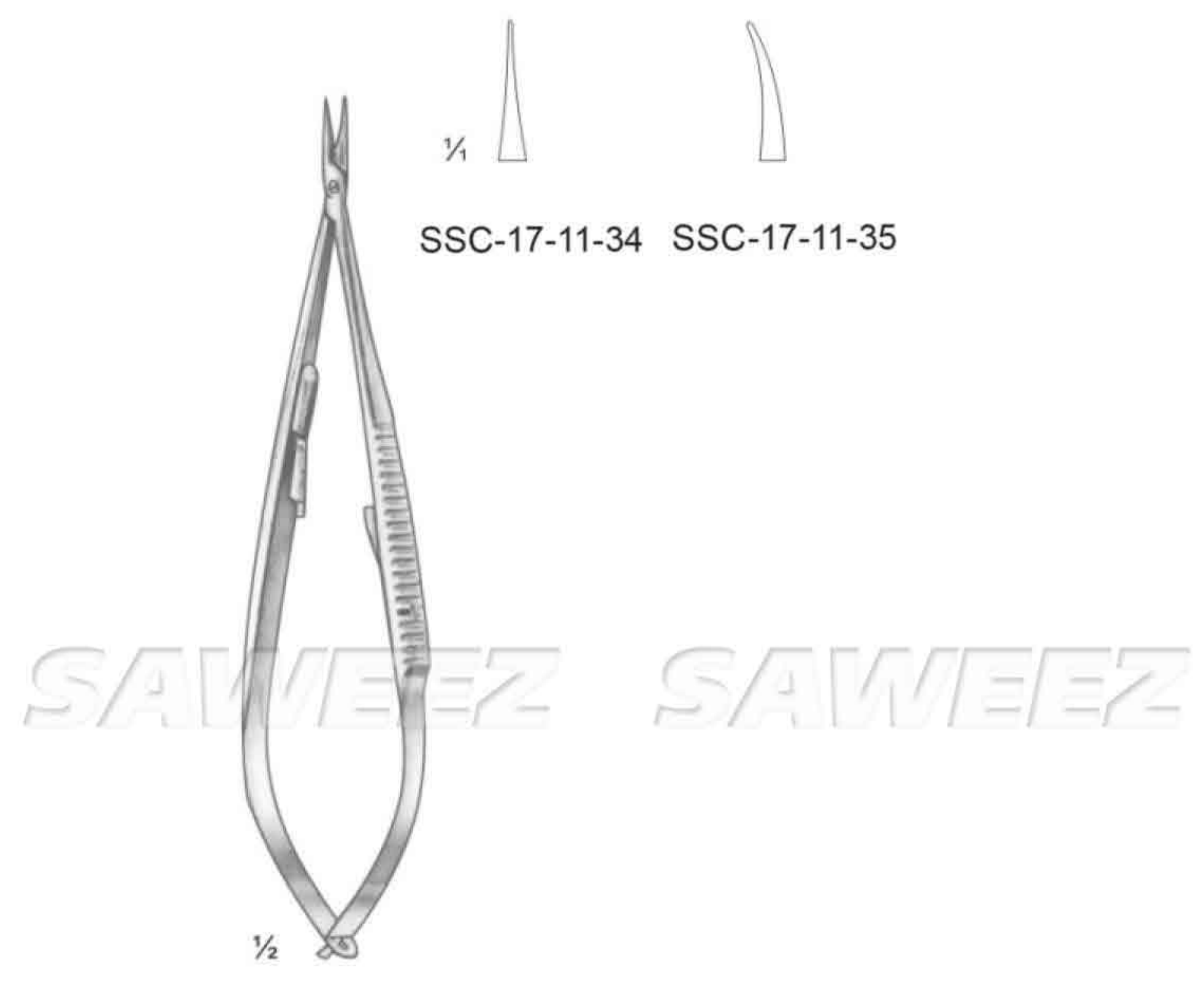


Castroviejo
9.0 cm / 3 1/2"

SAWEEZ SAWEEZ SAWEEZ SAWEEZ



Castroviejo
14.0 cm / 5 1/2"



Castroviejo
14.0 cm / 5 1/2"

SAWEEZ SAWEEZ SAWEEZ SAWEEZ

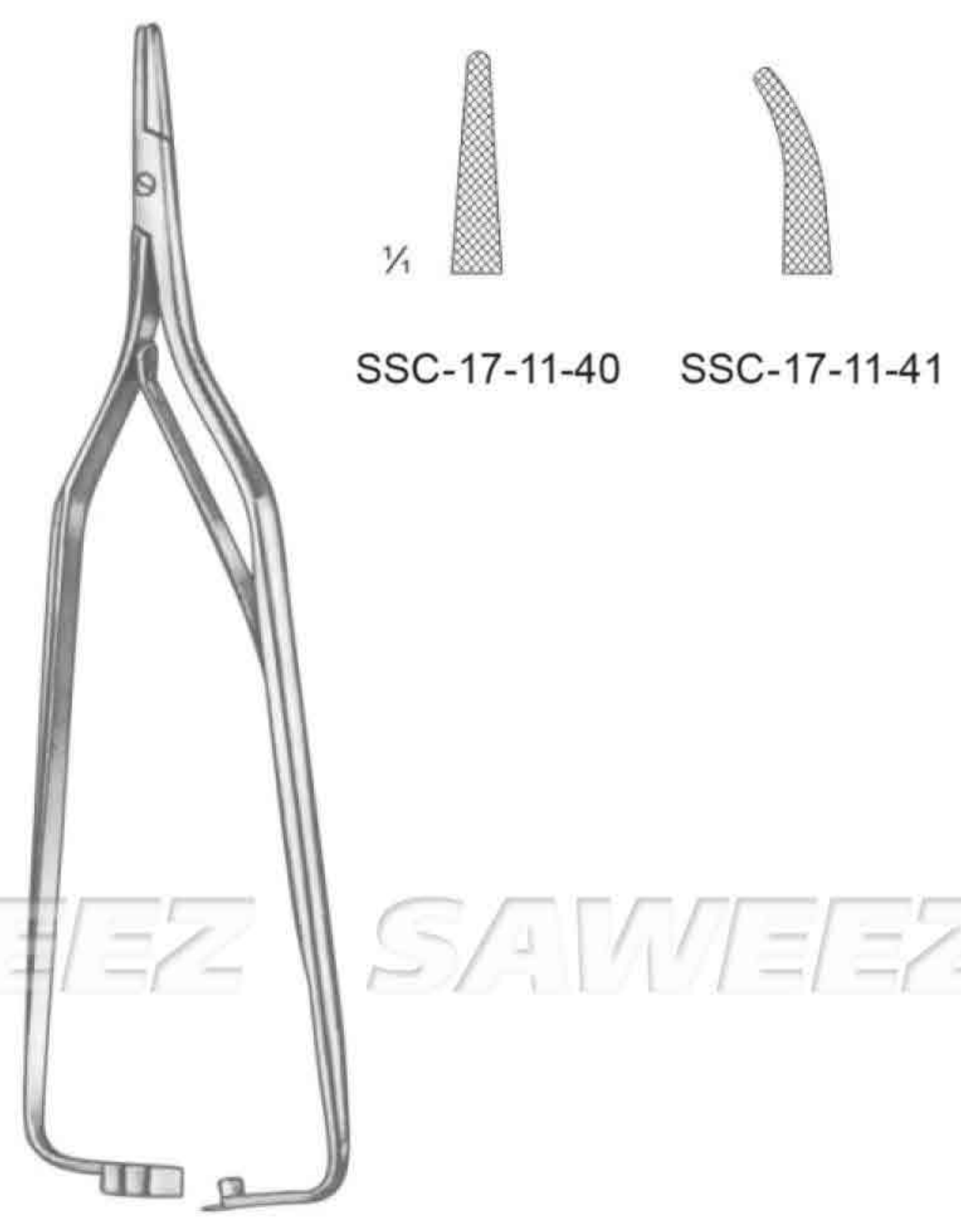


Castrovieijo

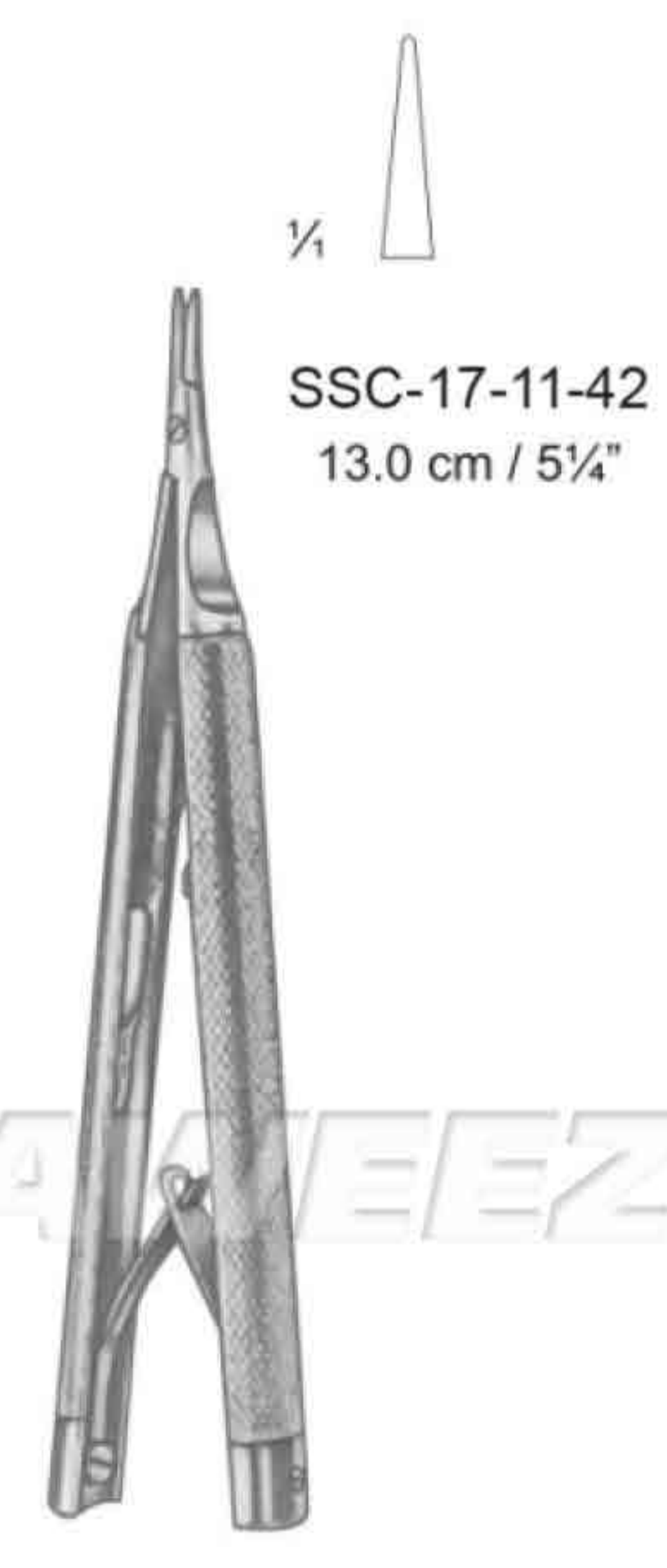


Castrovieijo

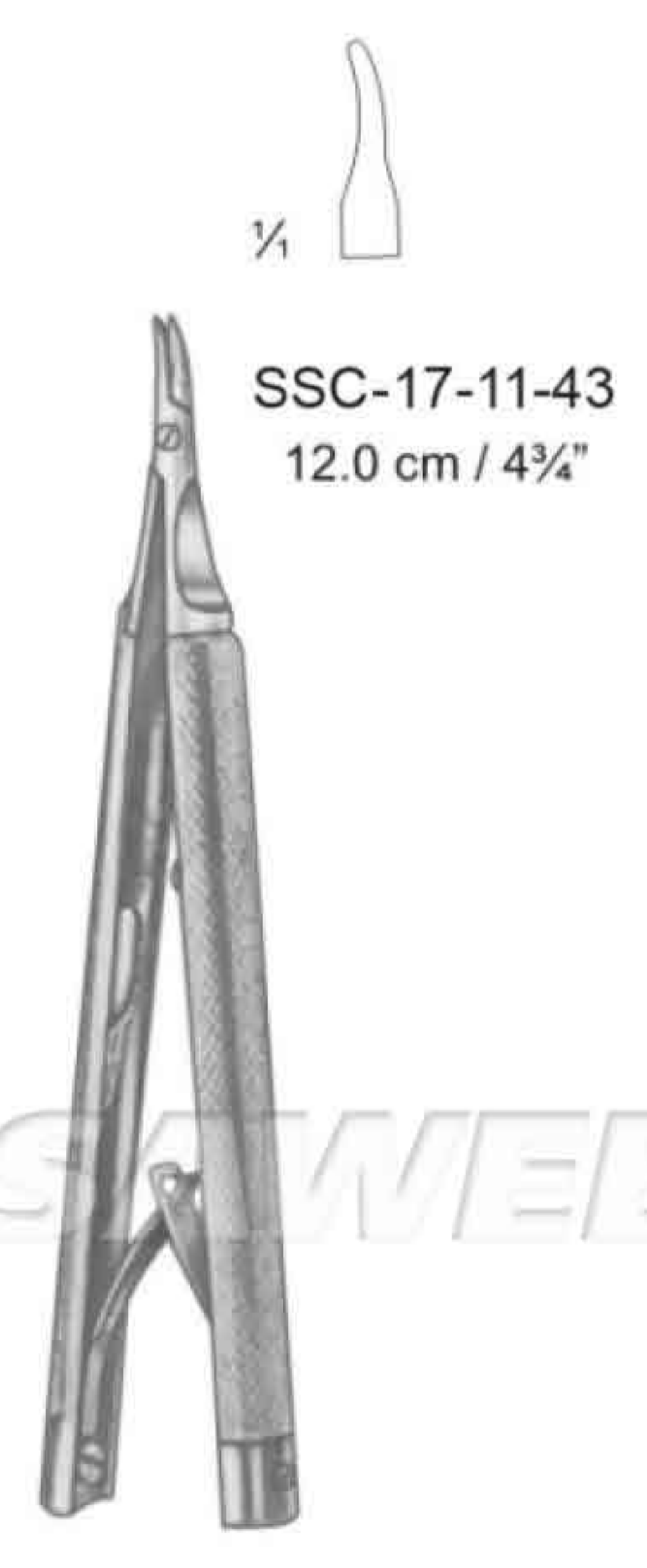
SAWEEZ SAWEEZ SAWEEZ SAWEEZ



Arruga
16.0 cm / 6 1/4"



Castrovieijo



Castrovieijo-Barraquer

SAWEEZ SAWEEZ SAWEEZ SAWEEZ

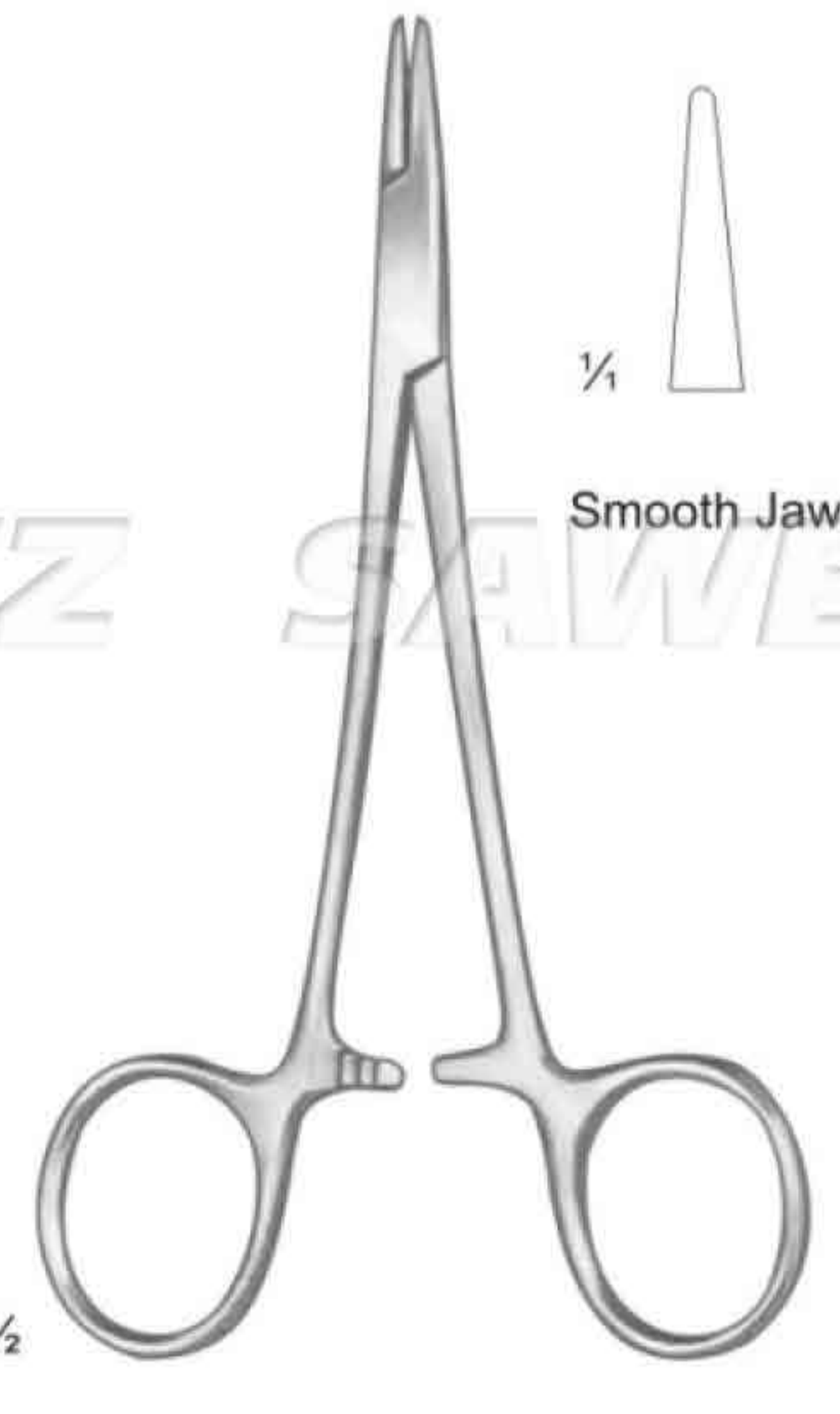


SSC-17-11-44 12.0 cm / 4 3/4"
SSC-17-11-45 12.5 cm / 5"

Derf



Collier
SSC-17-11-46
12.5 cm / 5"



Webster
SSC-17-11-47
13.0 cm / 5"

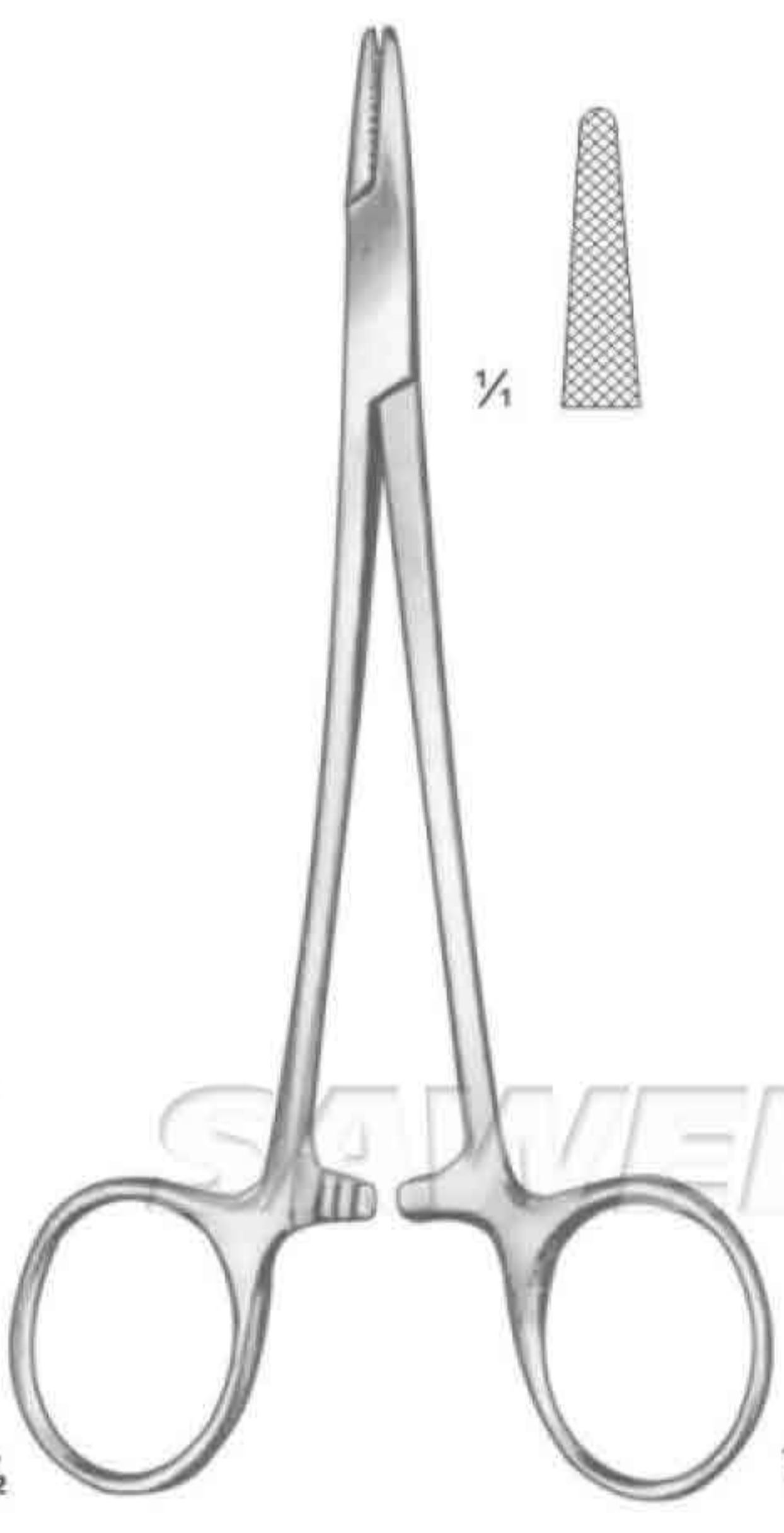
SAWEEZ SAWEEZ SAWEEZ SAWEEZ
Smooth Jaws, with special groove



Halsey
SSC-17-11-48
13.0 cm / 5"



Neivert
SSC-17-11-49
13.0 cm / 5"



Hegar-Baumgartner
SSC-17-11-50
14.0 cm / 5 1/2"



Brown
SSC-17-11-51 13.0 cm / 5"
SSC-17-11-52 18.0 cm / 7"



Crile-Murray
SSC-17-11-53
15.0 cm / 6"



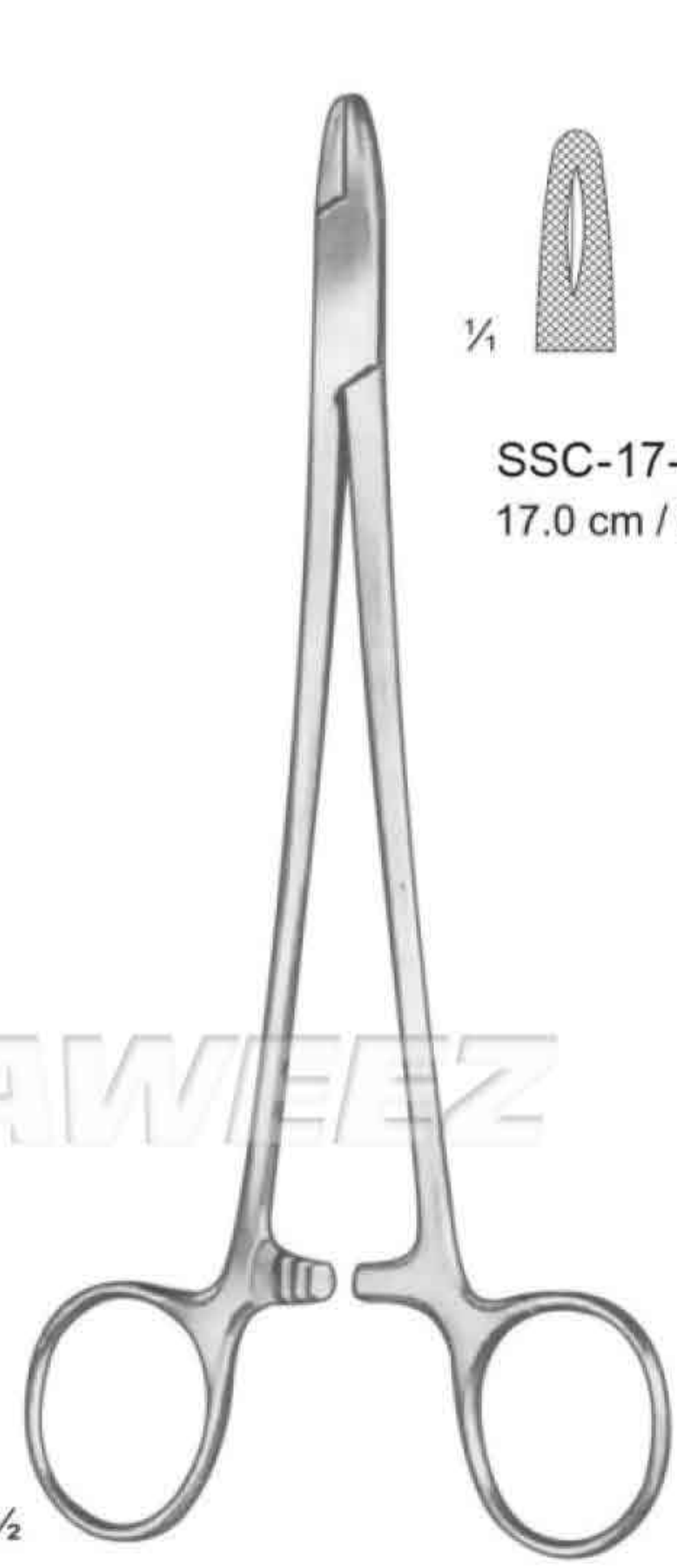
Crile-wood
SSC-17-11-54
15.0 cm / 6"



Adson
SSC-17-11-55
18.0 cm / 7"



Metzenbaum
SSC-17-11-56
18.0 cm / 7"

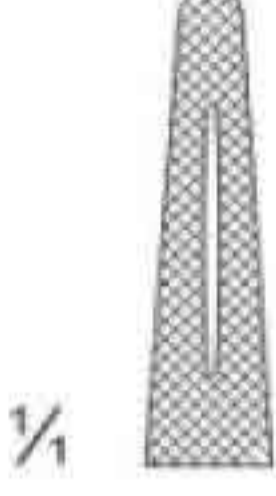
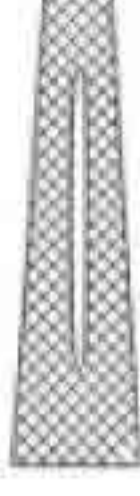






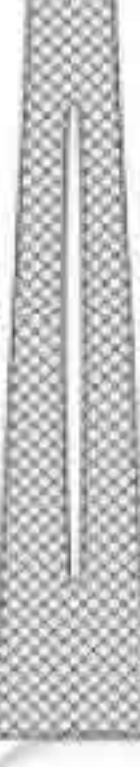
M.G.H (Mass-General-Hospital)

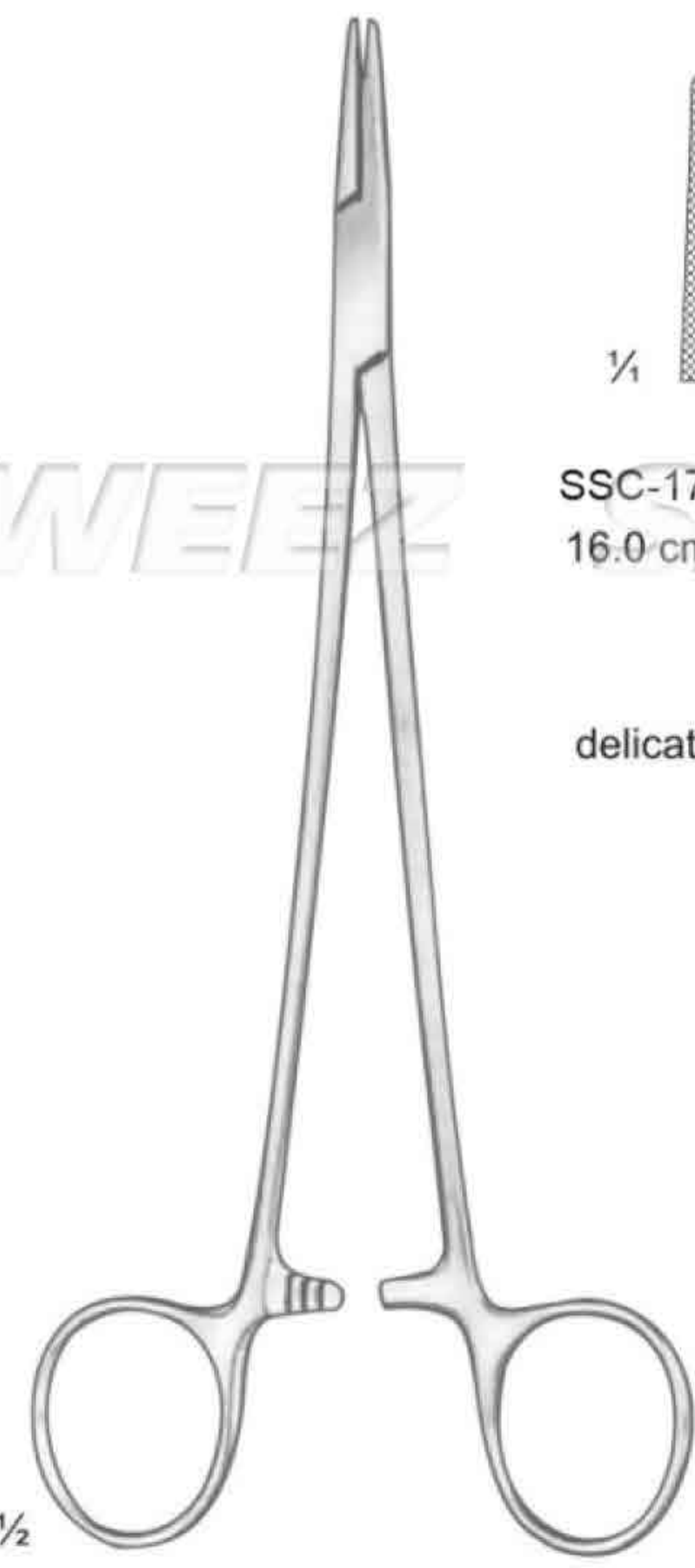


Mayo-Hegar

SSC-17-11-57
17.0 cm / 6 3/4"

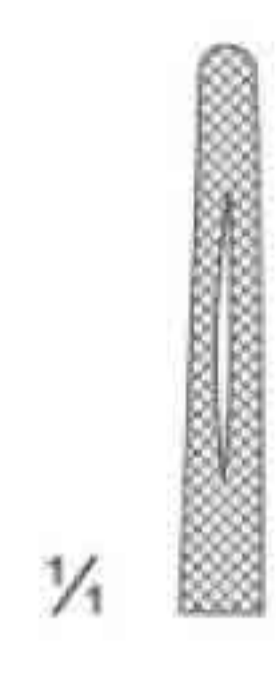
			
SSC-17-11-58 14.0 cm / 5 1/2"	SSC-17-11-59 16.0 cm / 6 1/4"	SSC-17-11-60 18.0 cm / 7"	SSC-17-11-61 20.0 cm / 8"

		
SSC-17-11-62 24.0 cm / 9 1/2"	SSC-17-11-63 26.0 cm / 10 1/4"	SSC-17-11-64 30.0 cm / 12"

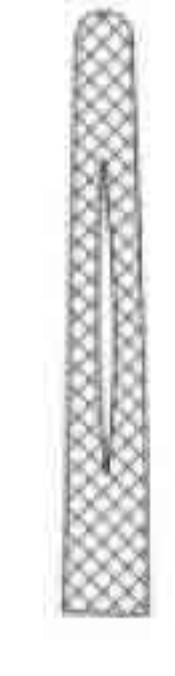


1/2

Mayo-Hegar



SSC-17-11-65
16.0 cm / 6 1/4"

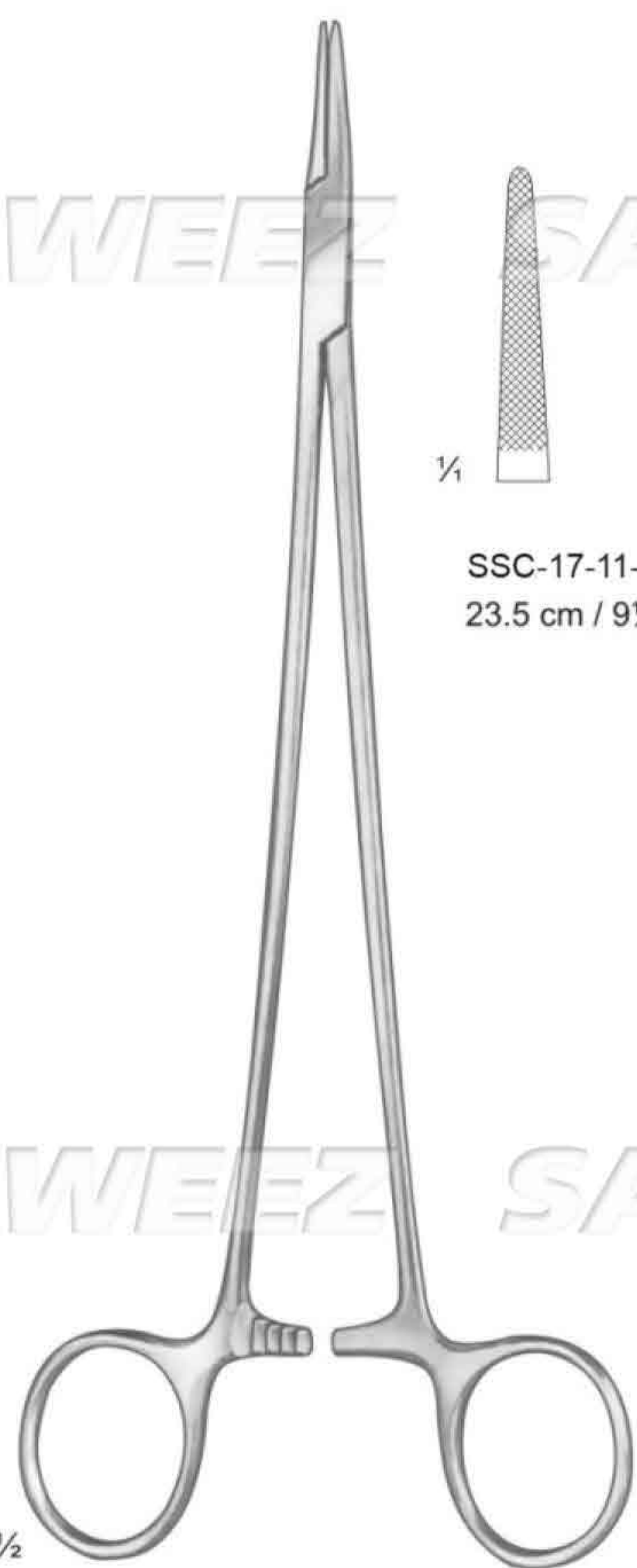


SSC-17-11-66
18.0 cm / 7"



SSC-17-11-67
20.0 cm / 8"

delicate pattern



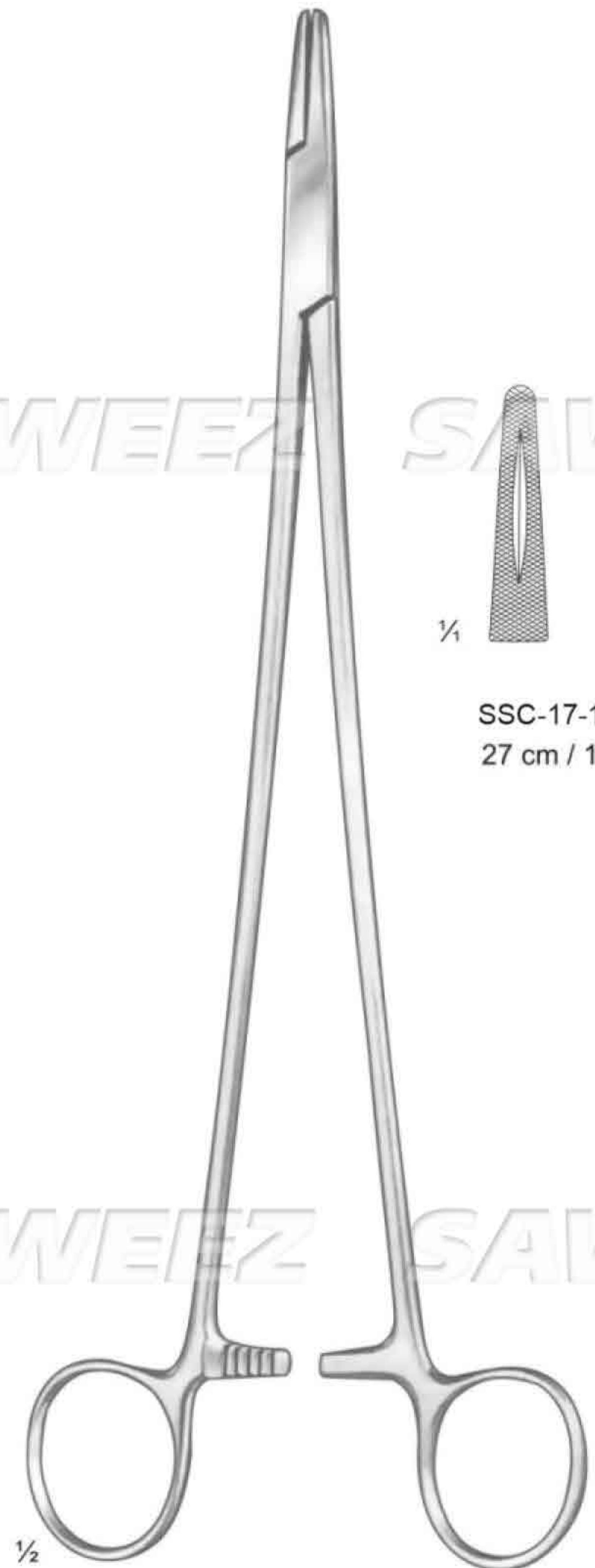
1/2

Jamison



1/4

SSC-17-11-68
23.5 cm / 9 1/4"



1/2

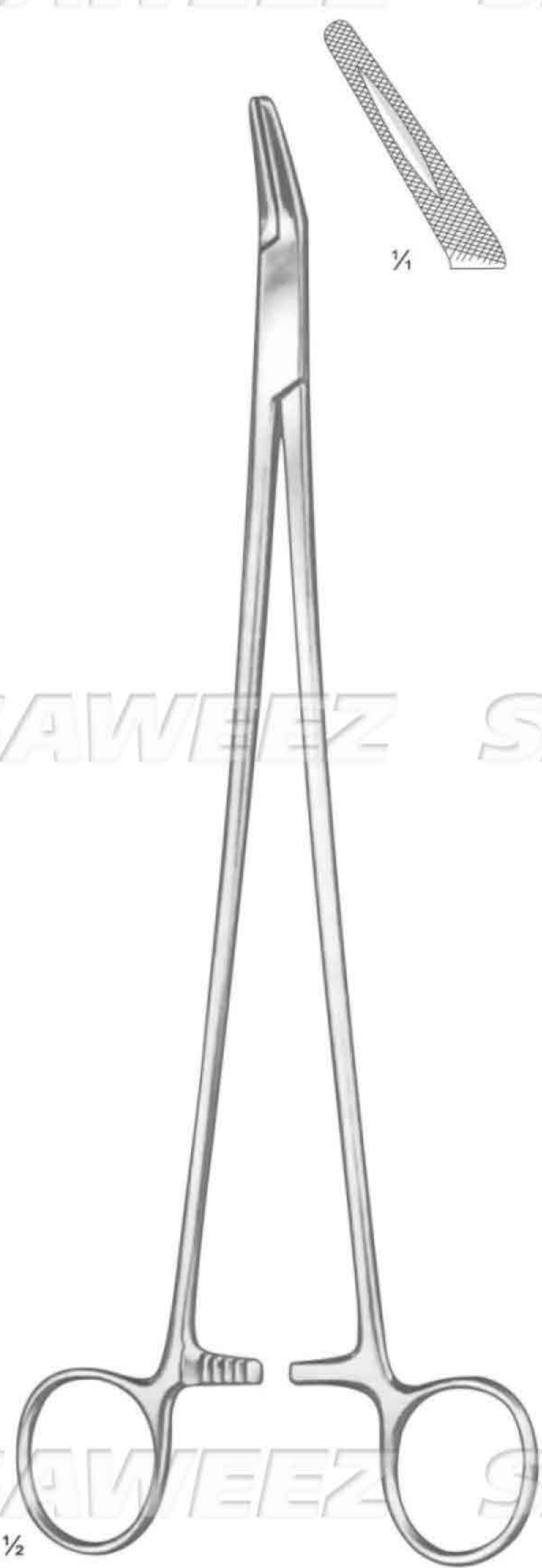
Masson



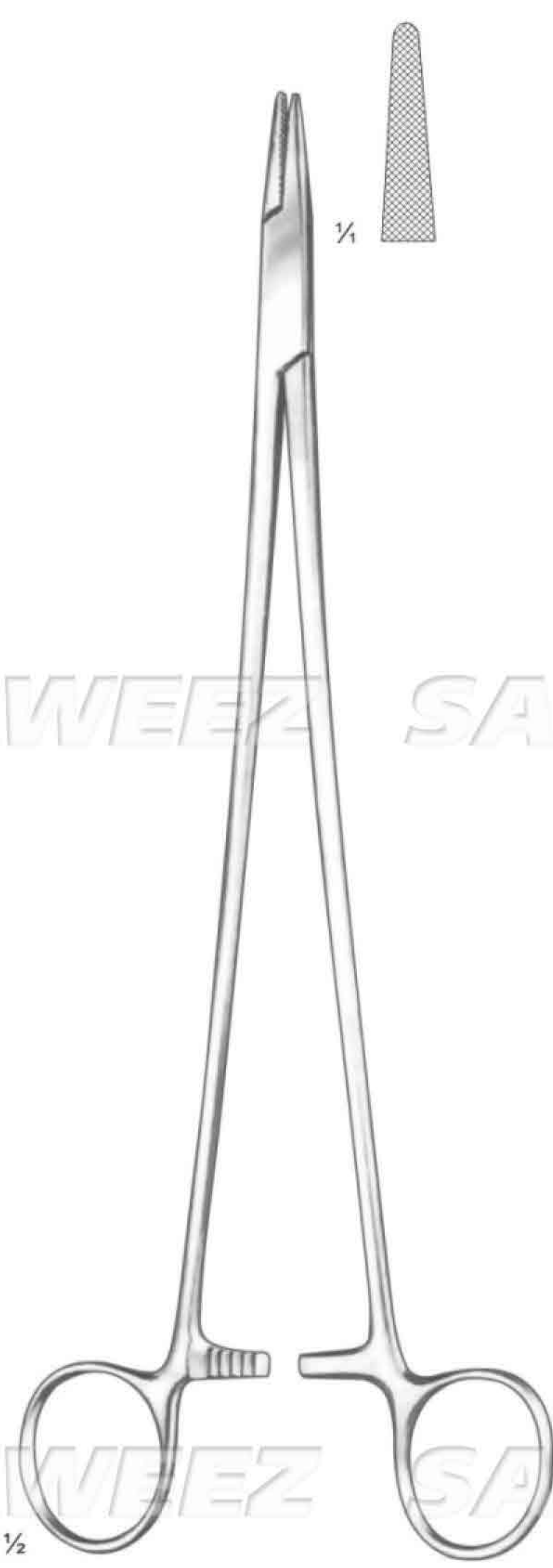
1/4

SSC-17-11-69
27 cm / 10 1/2"

SAWEEZ SAWEEZ SAWEEZ SAWEEZ



Finocchietto
SSC-17-11-70
27.0 cm / 10½"



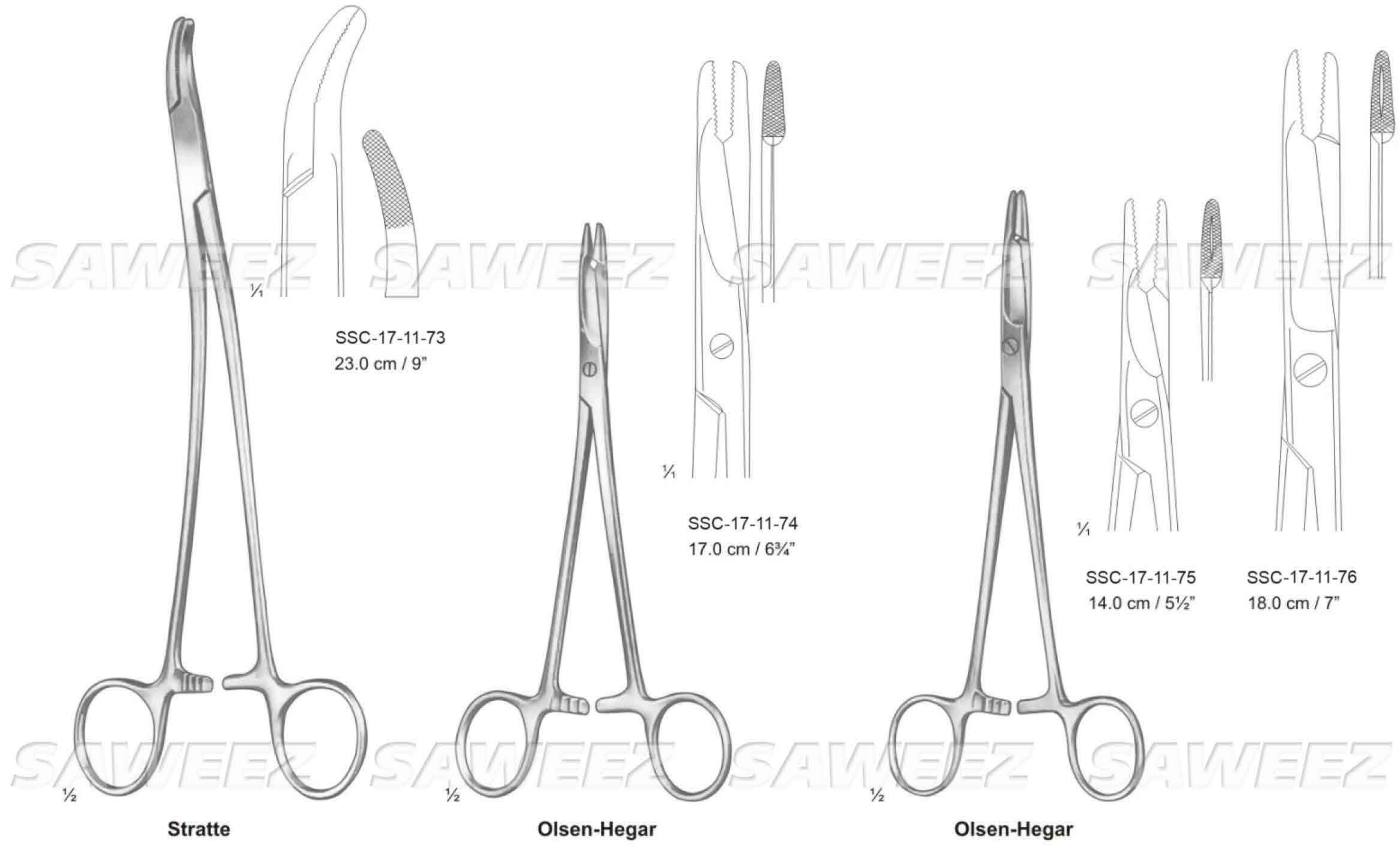
Wangenstein
SSC-17-11-71
27.0 cm / 10½"

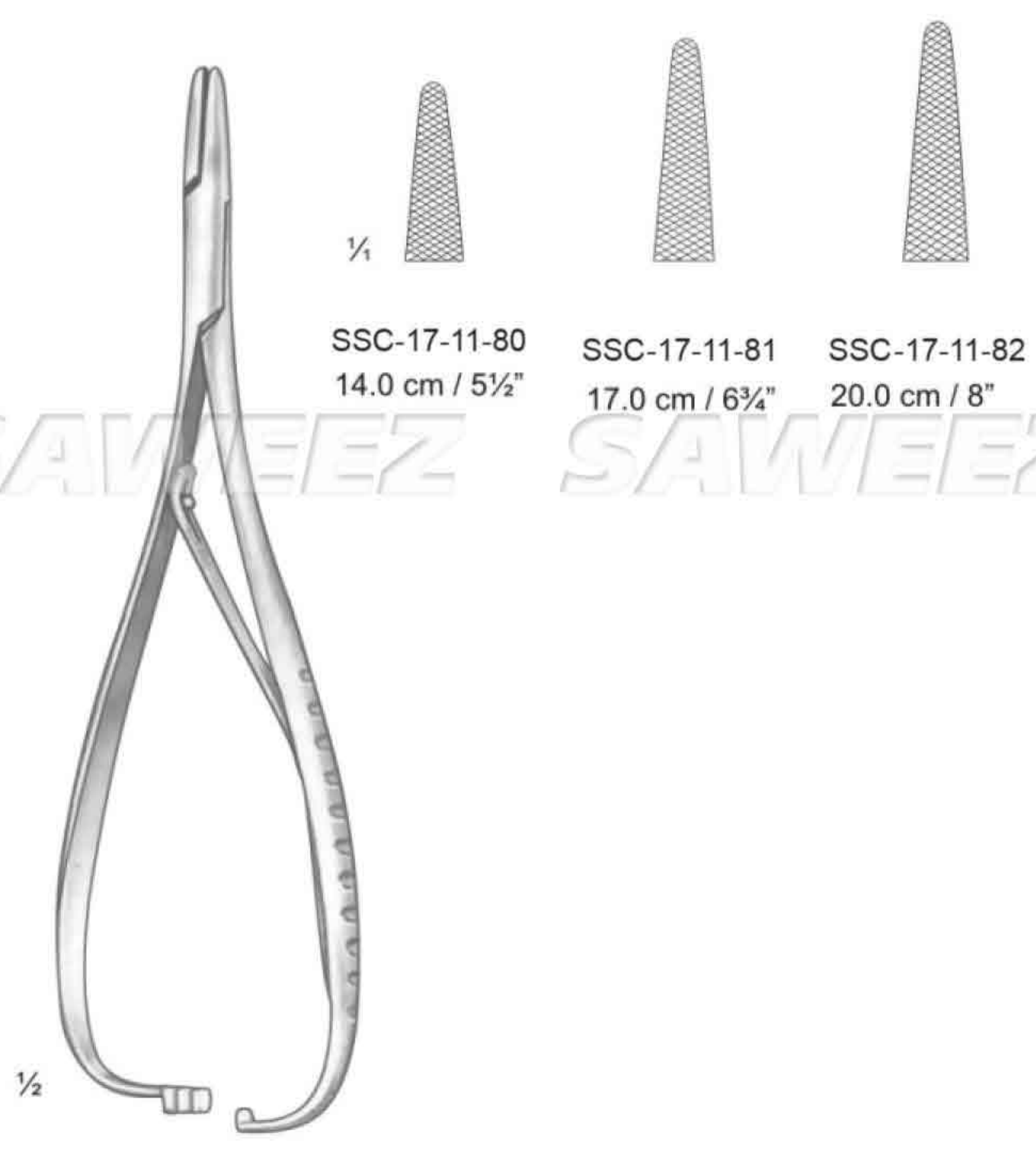


Johnson
SSC-17-11-72
27.0 cm / 10½"

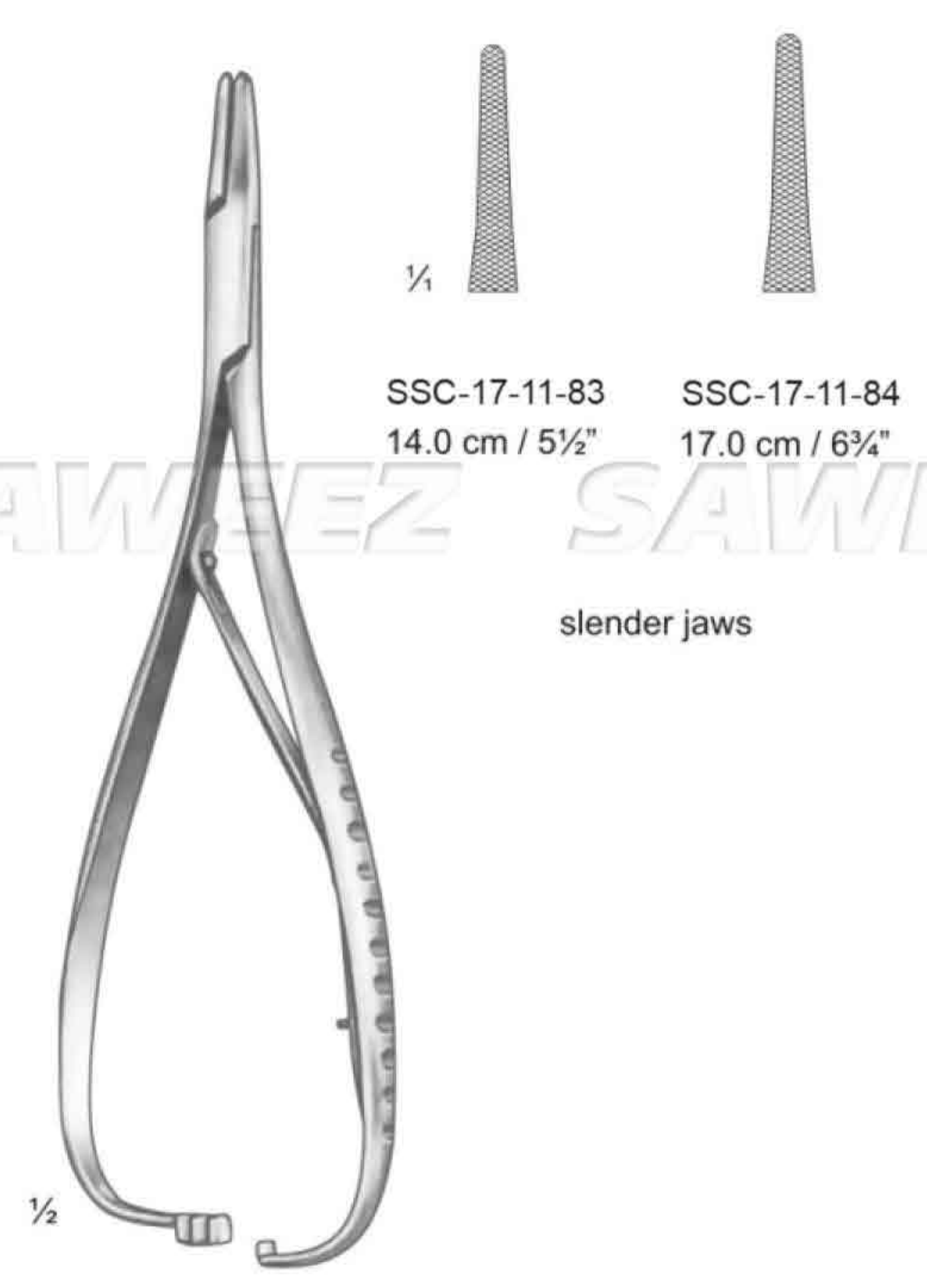
SAWEEZ SAWEEZ SAWEEZ SAWEEZ

SAWEEZ SAWEEZ SAWEEZ SAWEEZ

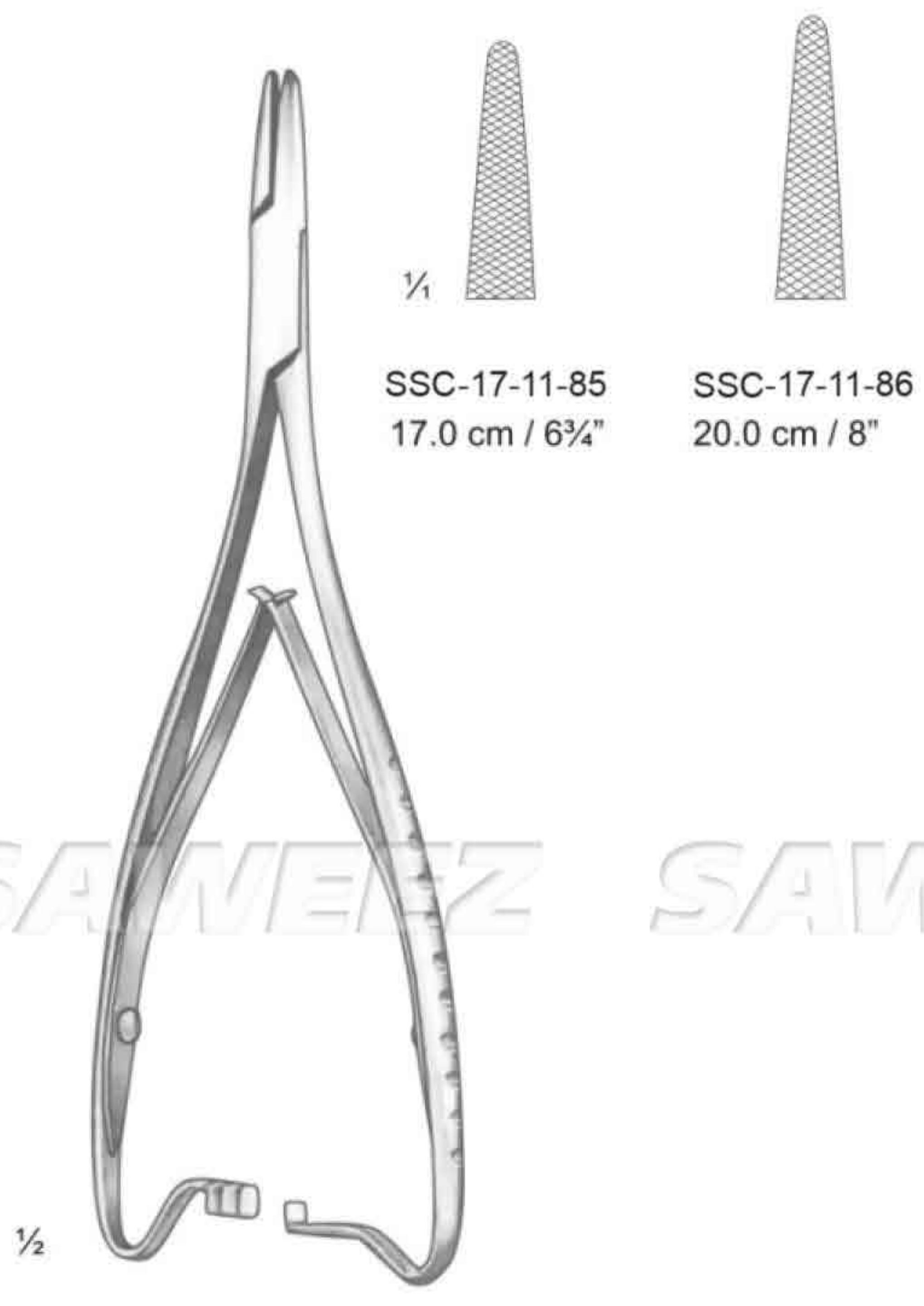




Mathieu



Mathieu



Mathieu



Toennis



Lichtenberg



1/2

Reverdin
14.0 cm / 5 1/2"



1/4

Fig. 1
SSC-17-11-89



Fig. 2
SSC-17-11-90



Fig. 3
SSC-17-11-91



Fig. 4
SSC-17-11-92



1/2

Reverdin
22.5 cm / 8 3/4"
SSC-17-11-93 SSC-17-11-96



1/4

Fig. 1
SSC-17-11-93
SSC-17-11-97



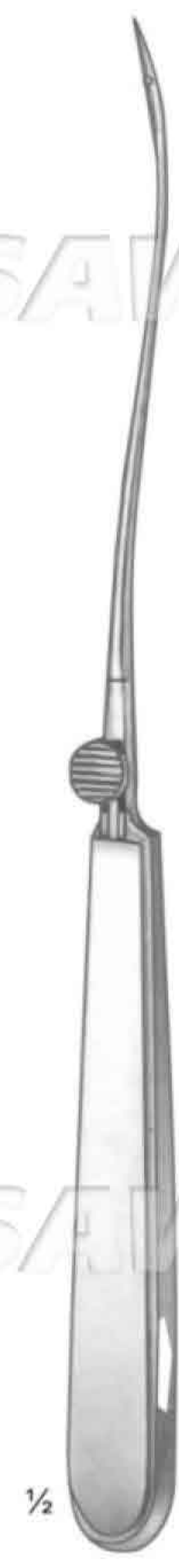
Fig. 2
SSC-17-11-94
SSC-17-11-98



Fig. 3
SSC-17-11-95
SSC-17-11-99

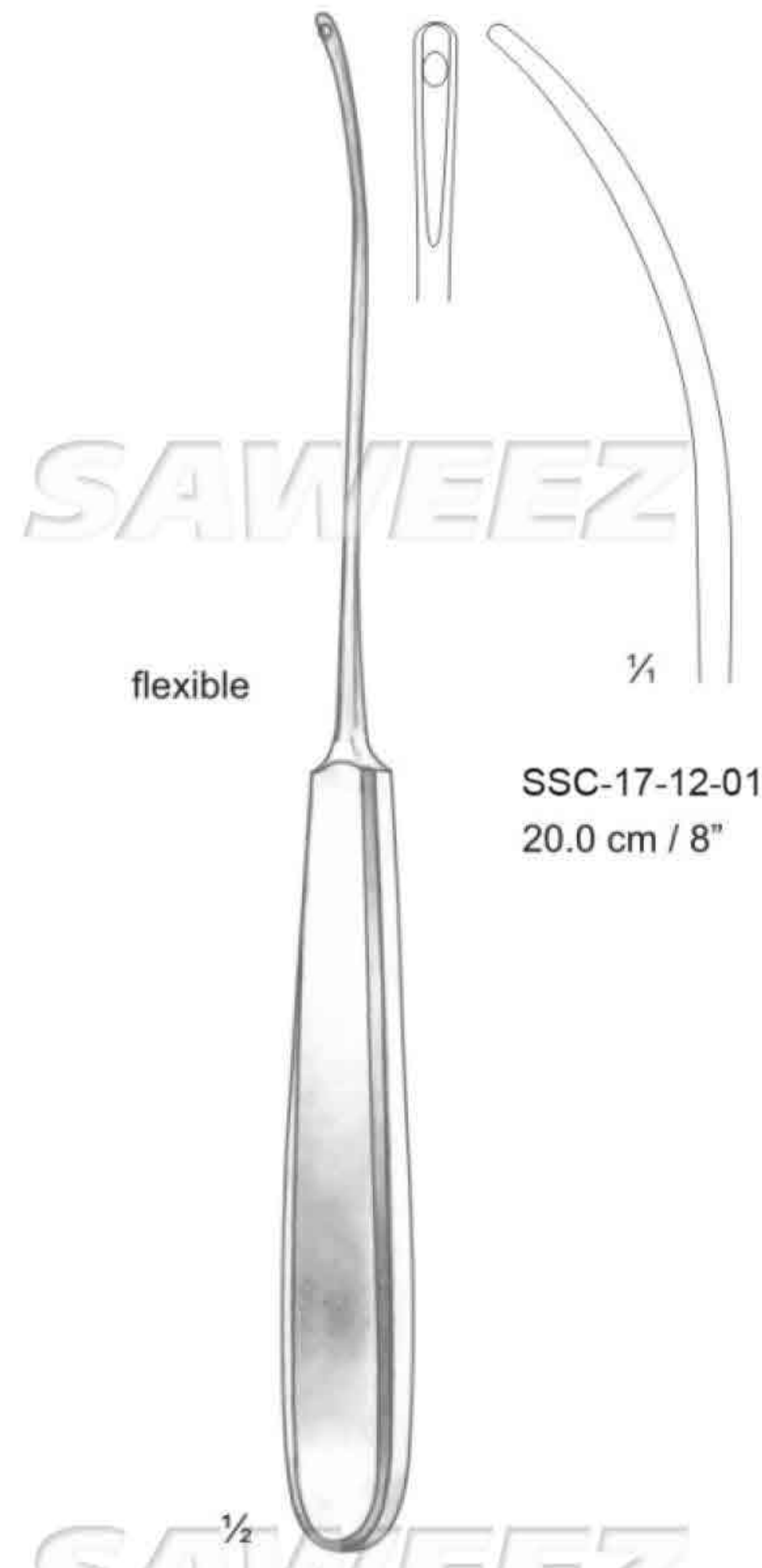


Fig. 4
SSC-17-11-96
SSC-17-12-00



1/2

Reverdin
19.5 cm / 7 3/4"
SSC-17-11-97 SSC-17-12-00



flexible

1/2

SSC-17-12-01
20.0 cm / 8"



1/2

SSC-17-12-02
19.0 cm / 7 1/2"

Cooper



curved to left,
for the right
Hand

1/2



curved to right,
for the right
Hand

1/2

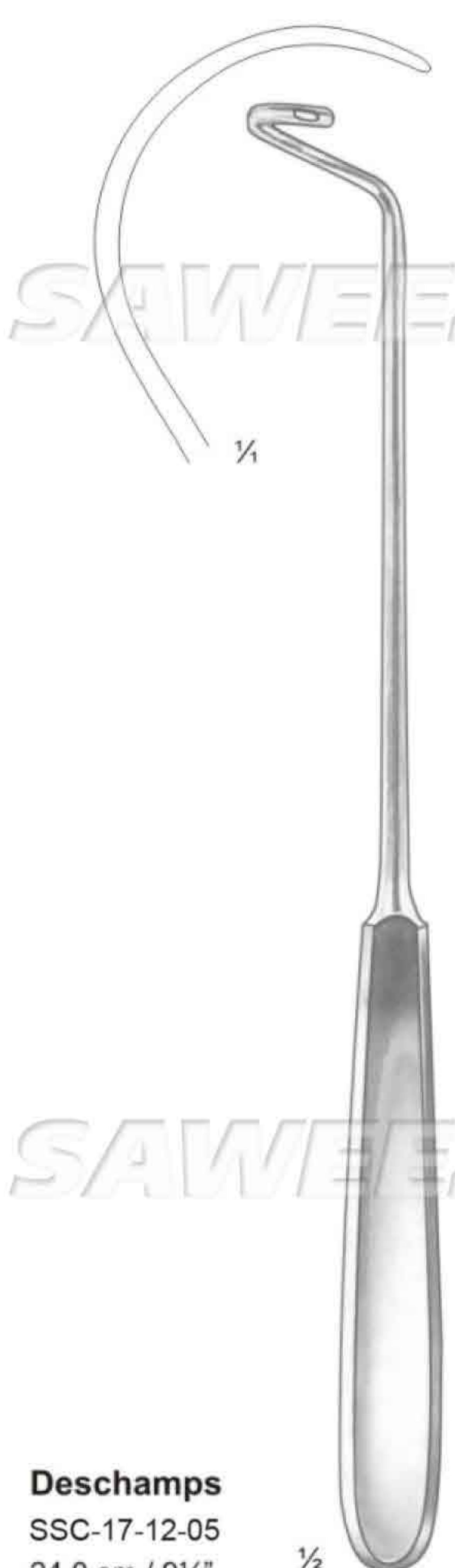


1/2

Kronecker
SSC-17-12-03
13.0 cm / 5"



Kronecker
SSC-17-12-04
13.0 cm / 5"



1/2

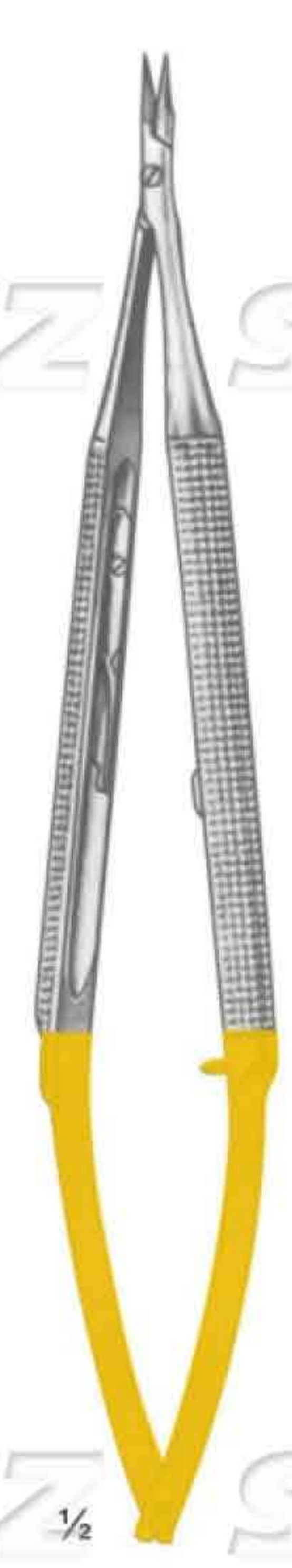
Deschamps
SSC-17-12-05
24.0 cm / 9 1/2"



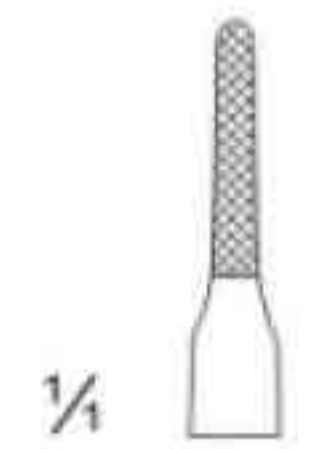
1/2

Deschamps
SSC-17-12-06
24.0 cm / 9 1/2"

TC GOLD



Vascular
18.0 cm / 7"



SSC-17-12-07
with lock



SSC-17-12-08
with lock



SSC-17-12-09
without lock



SSC-17-12-10
without lock

Micro profile



Dietrich



SSC-17-12-11
16.0 cm / 6¼"



SSC-17-12-12
18.0 cm / 7"



SSC-17-12-13
20.0 cm / 8"



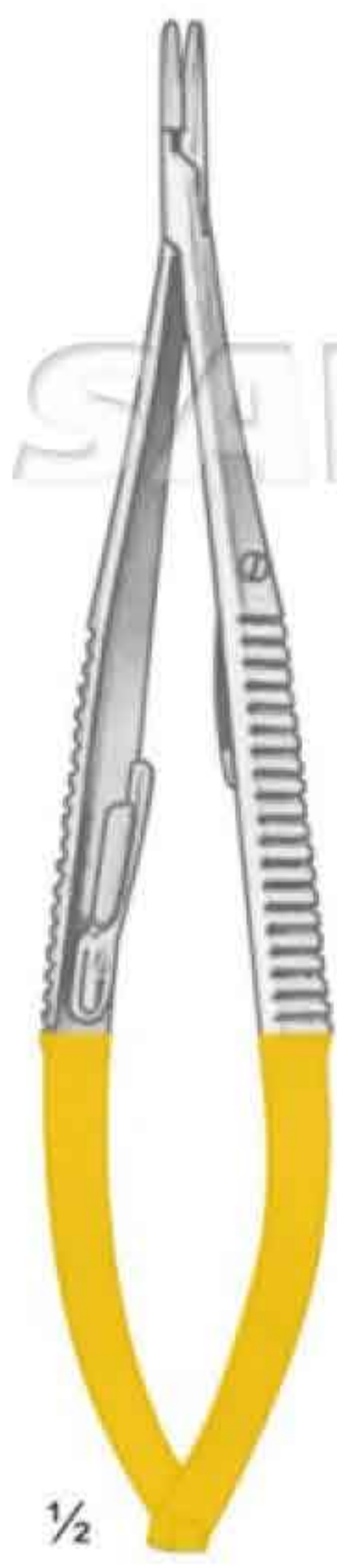
SSC-17-12-14
23.0 cm / 9"



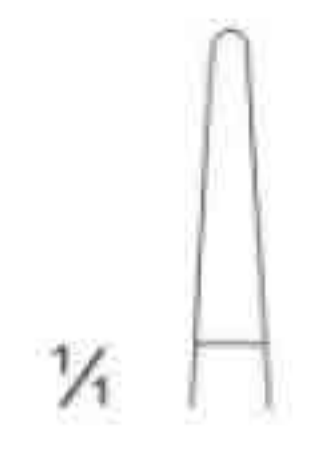
SSC-17-12-15
26.0 cm / 10¼"

Micro profile

TC GOLD



Castroviejo



SSC-17-12-16
14.0 cm / 5½"
smooth



SSC-17-12-17
18.0 cm / 7"
Micro profile



SSC-17-12-18
21.0 cm / 8¼"
Micro profile



SSC-17-12-19
14.0 cm / 5½"
smooth



SSC-17-12-20
18.0 cm / 7"
Micro profile



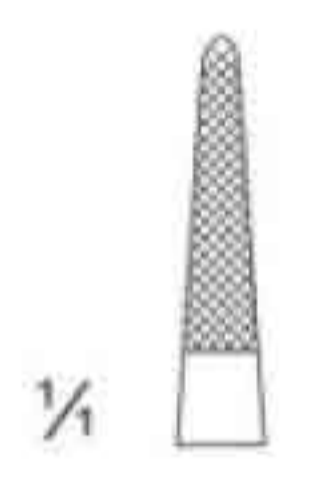
SSC-17-12-21
21.0 cm / 8¼"
Micro profile

SAWEEZ SAWEEZ SAWEEZ SAWEEZ

SAWEEZ SAWEEZ SAWEEZ SAWEEZ

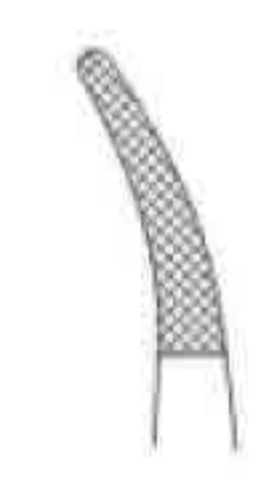


Arruga

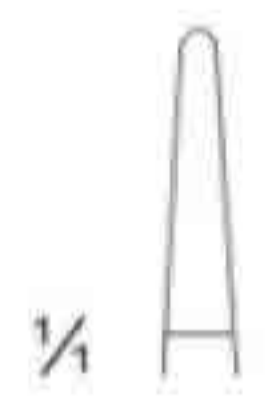


SSC-17-12-22
16.0 cm / 6¼"

Mini profile



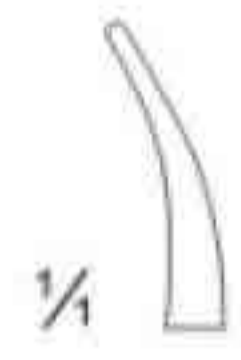
SSC-17-12-23
16.0 cm / 6¼"



SSC-17-12-24
13.0 cm / 5"
smooth



SSC-17-12-25
13.0 cm / 5"
smooth

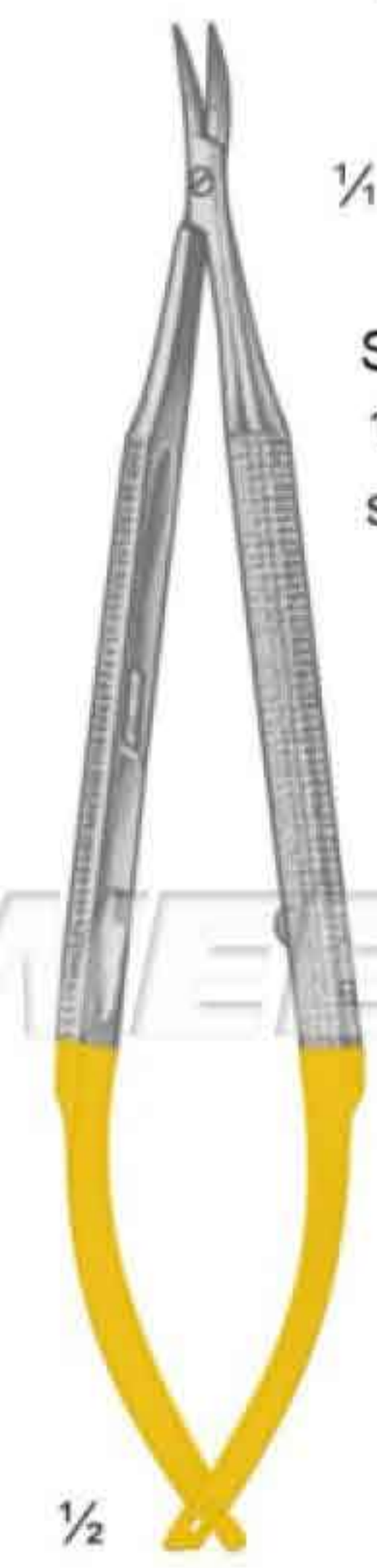


SSC-17-12-26
13.0 cm / 5"
smooth

SAWEEZ SAWEEZ SAWEEZ SAWEEZ



Castroviejo



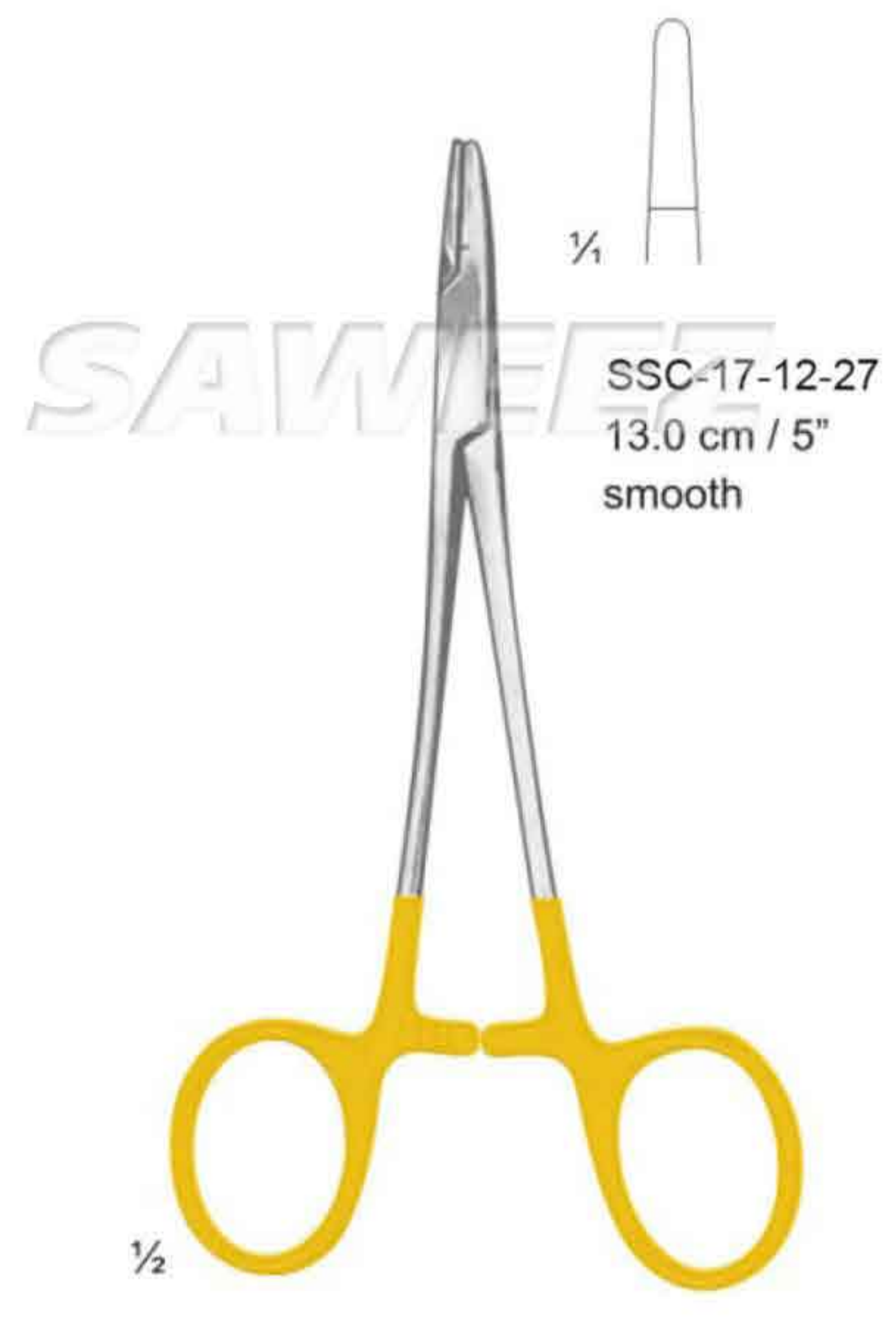
Barraquer



Barraquer



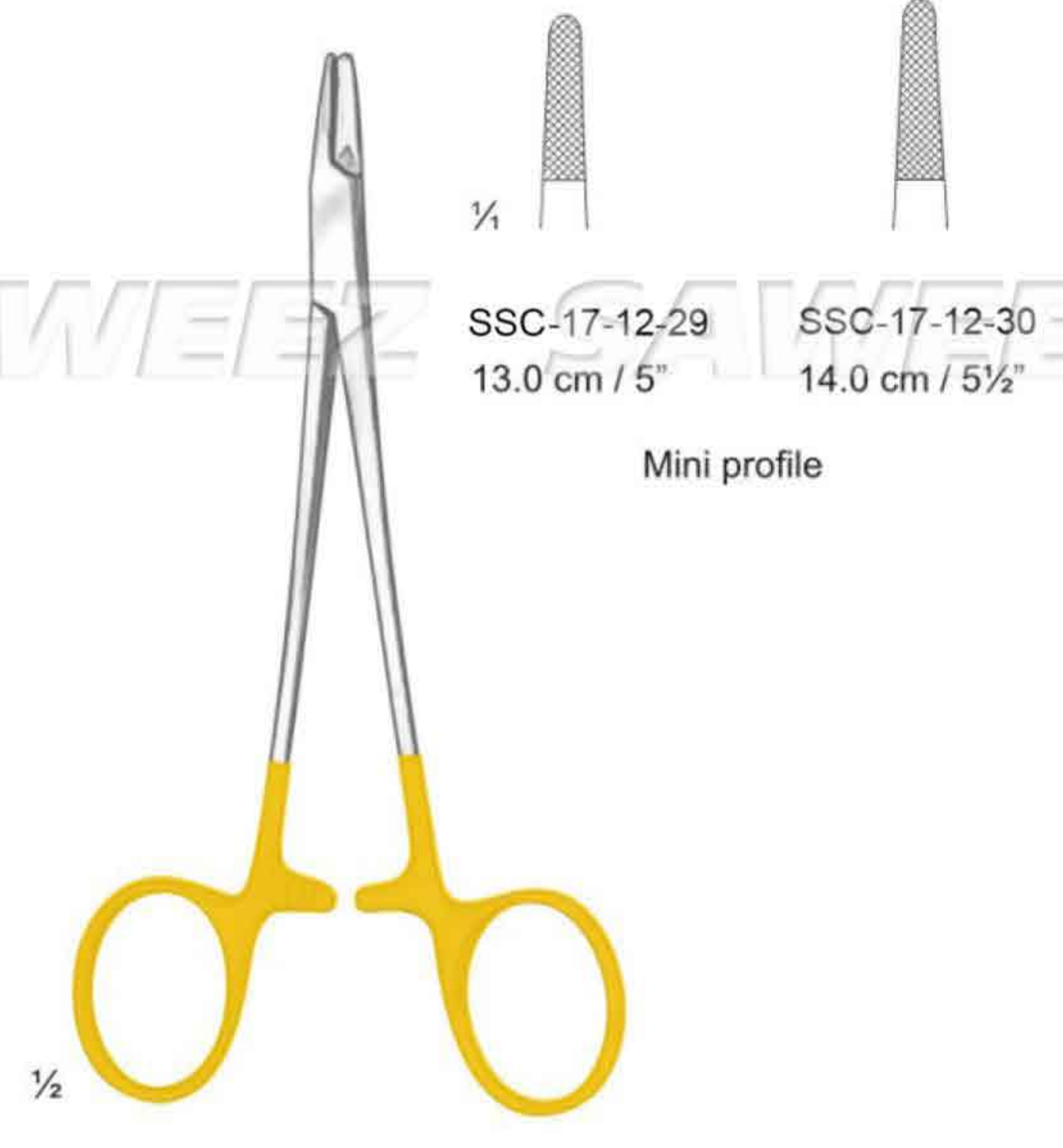
TC GOLD



Webster



Derf

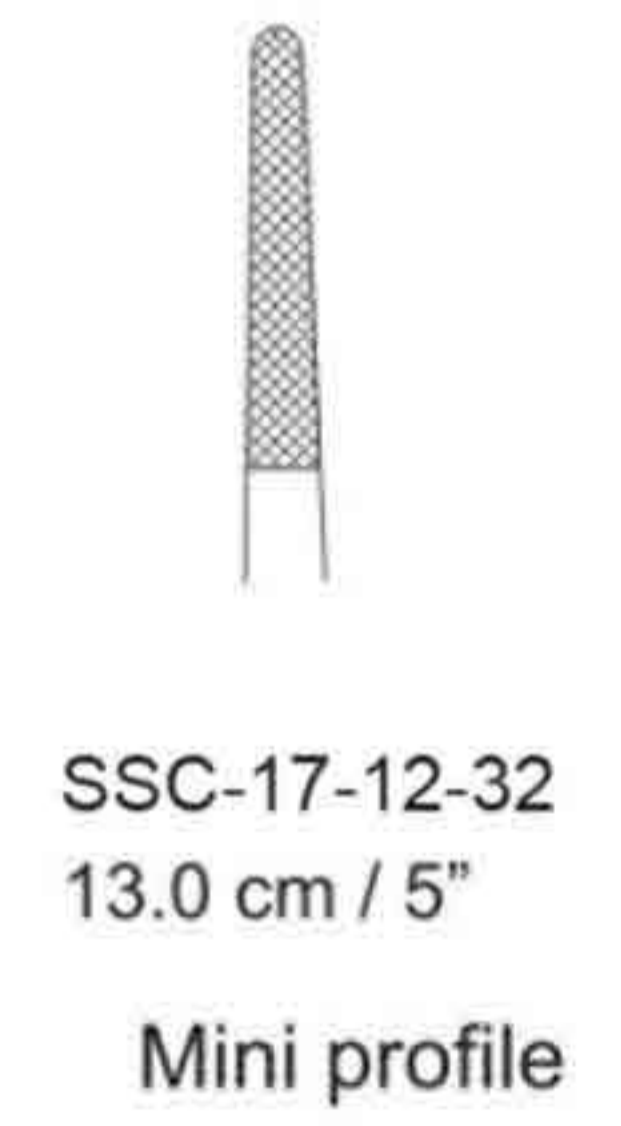


Hegar-Baumgartner

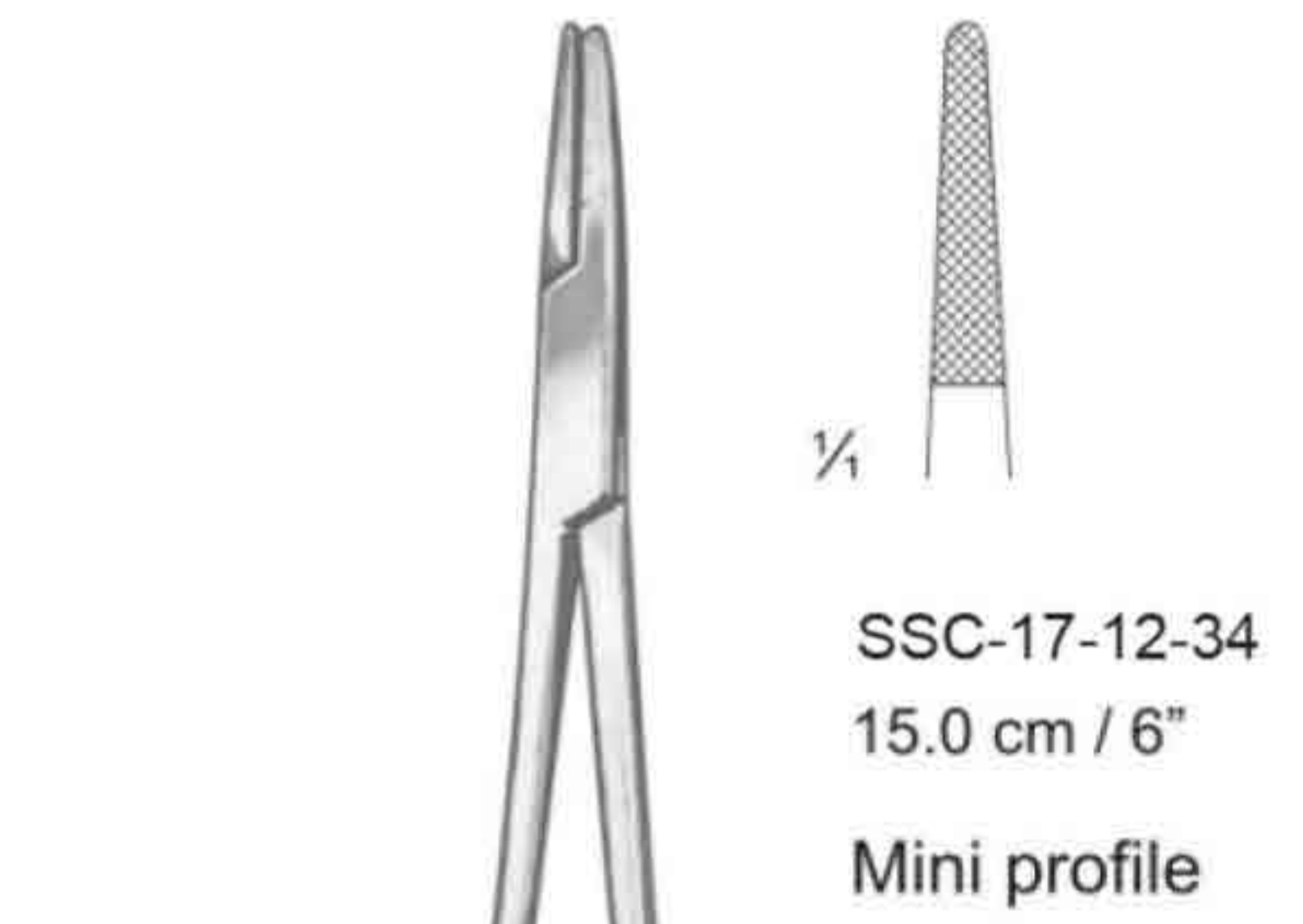
SAWEEZ SAWEEZ SAWEEZ SAWEEZ



Halsey



Webster



Crile-Wood

SAWEEZ SAWEEZ SAWEEZ SAWEEZ



TC / GOLD



Sarot

- SSC-17-12-35
20.0 cm / 8"
 - SSC-17-12-36
26.0 cm / 10 1/4"
- Normal profile



Mayo-Hegar

- SSC-17-12-37
16.0 cm / 6 1/4"
 - SSC-17-12-38
18.0 cm / 7"
 - SSC-17-12-39
20.0 cm / 8"
 - SSC-17-12-40
24.0 cm / 9 1/2"
 - SSC-17-12-41
26.0 cm / 10 1/4"
 - SSC-17-12-42
30.0 cm / 12"
- Normal profile



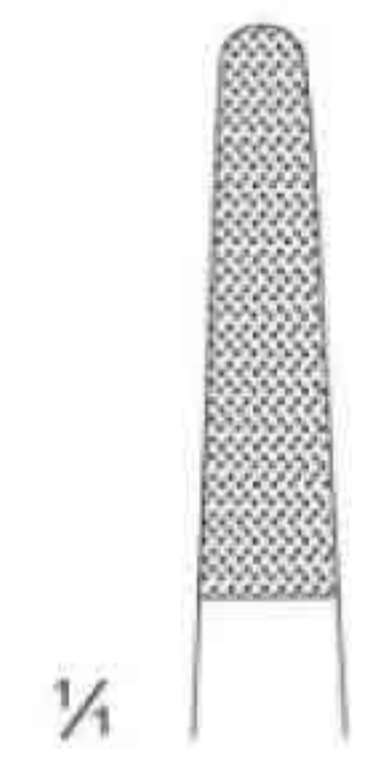
- SSC-17-12-43
20.0 cm / 8"
 - SSC-17-12-44
24.0 cm / 9 1/4"
 - SSC-17-12-45
26.0 cm / 10 1/4"
- Normal profile



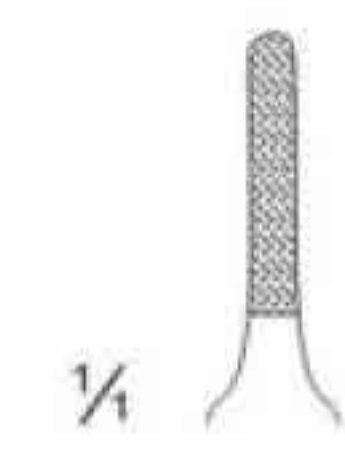
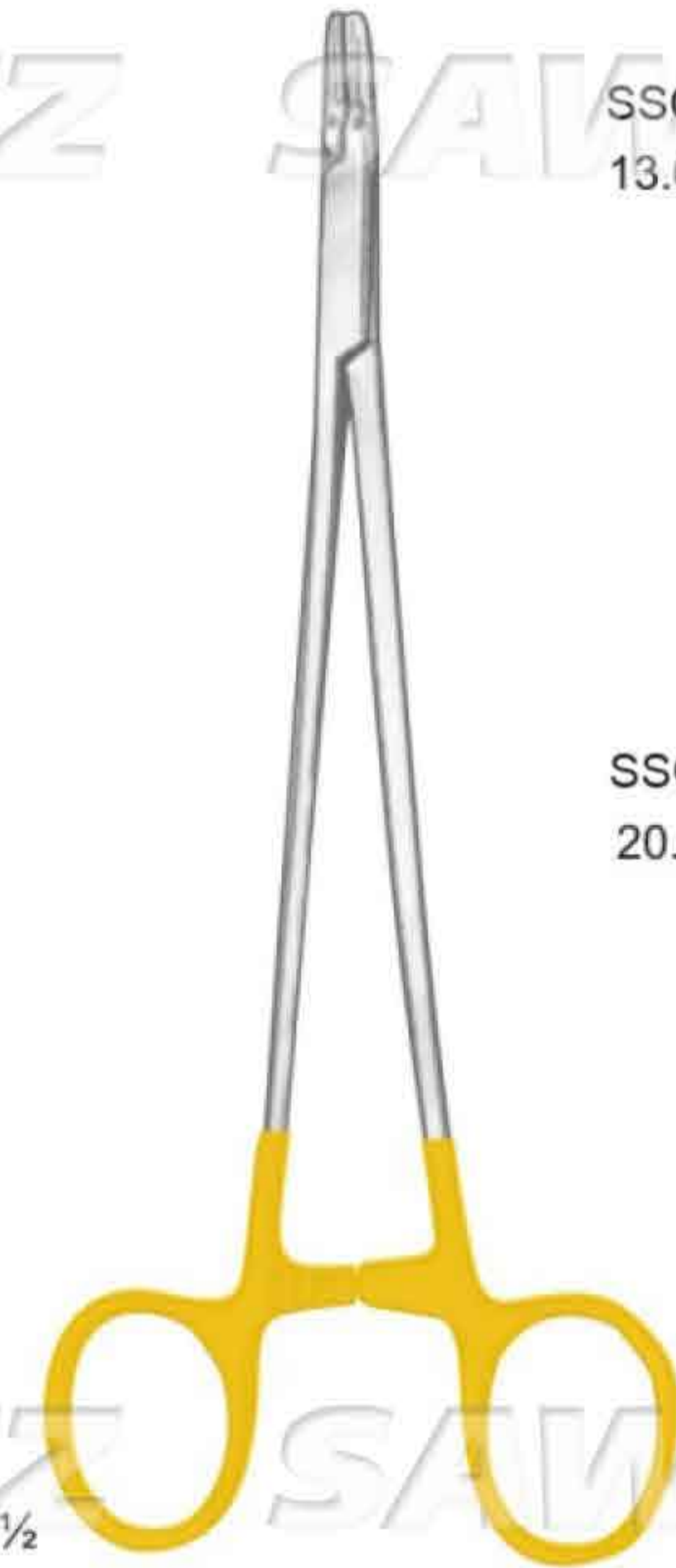
De Bakkey

- SSC-17-12-46
18.0 cm / 7"
 - SSC-17-12-47
20.0 cm / 8"
 - SSC-17-12-48
23.0 cm / 9"
 - SSC-17-12-49
26.0 cm / 10 1/4"
 - SSC-17-12-50
31.0 cm / 12 1/4"
 - SSC-17-12-51
37.0 cm / 14 1/2"
- Mini profile

TC GOLD



SSC-17-12-52
27.0 cm / 10½"
Normal profile



SSC-17-12-53
13.0 cm / 5"



SSC-17-12-54
15.0 cm / 6"



SSC-17-12-55
18.0 cm / 7"



SSC-17-12-56
20.0 cm / 8"



SSC-17-12-57
23.0 cm / 9"

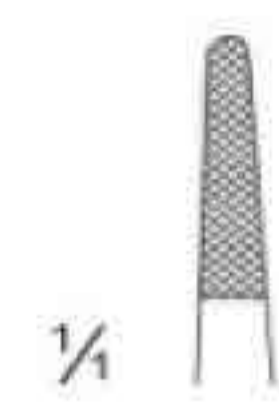


SSC-17-12-58
26.0 cm / 10¼"

Mini profile

Masson

Ryder



SSC-17-12-59
15.0 cm / 6"



SSC-17-12-60
17.0 cm / 6¾"



SSC-17-12-61
20.0 cm / 8"

Mini profile

Special Model

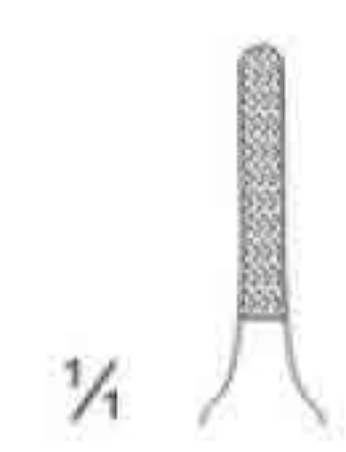
TC / GOLD

SAWEEZ SAWEEZ SAWEEZ SAWEEZ



SSC-17-12-62
27.0 cm / 10 1/2"
Normal profile

Finocchietto



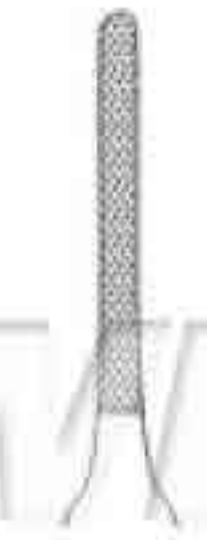
SSC-17-12-63
13.0 cm / 5"



SSC-17-12-64
15.0 cm / 6"



SSC-17-12-66
18.0 cm / 7"



SSC-17-12-67
20.0 cm / 8"

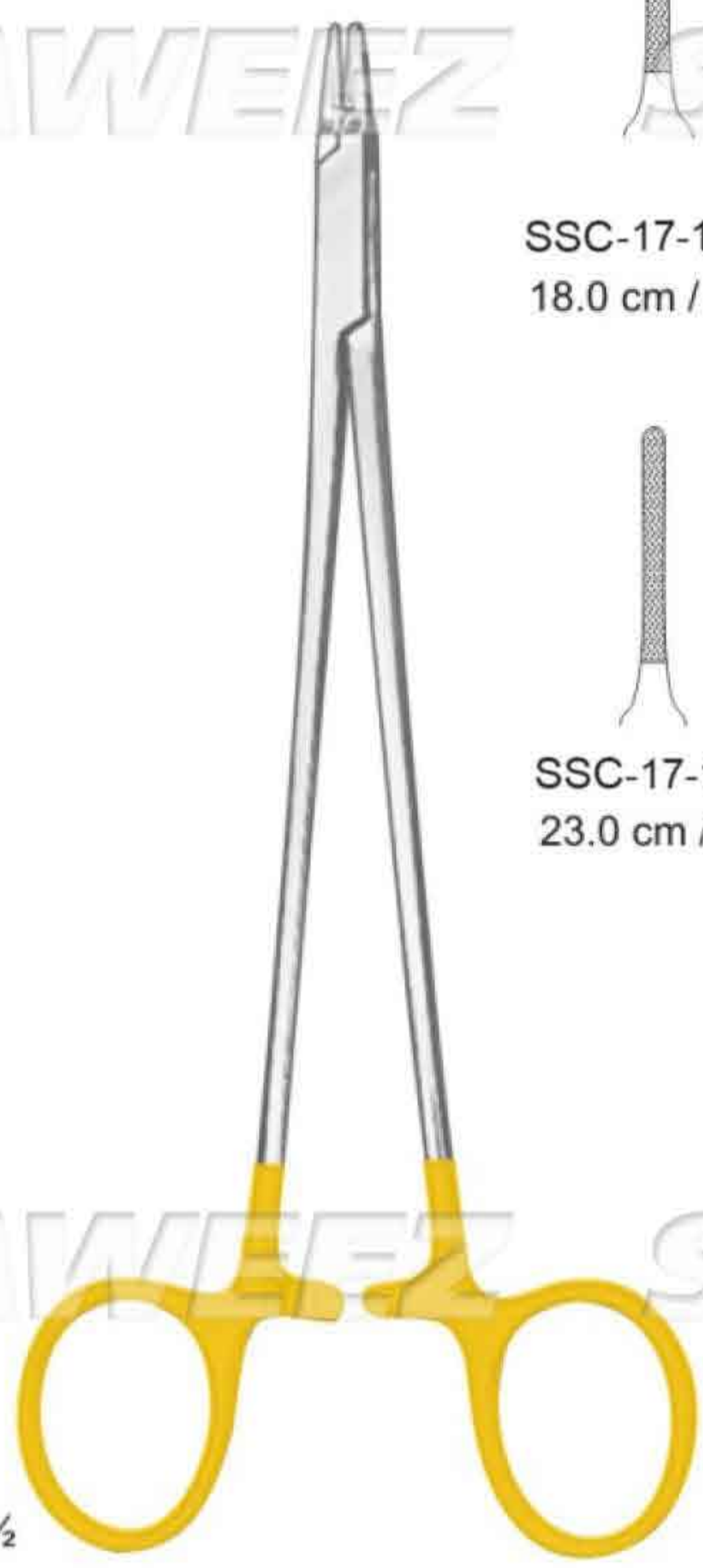


SSC-17-12-68
23.0 cm / 9"

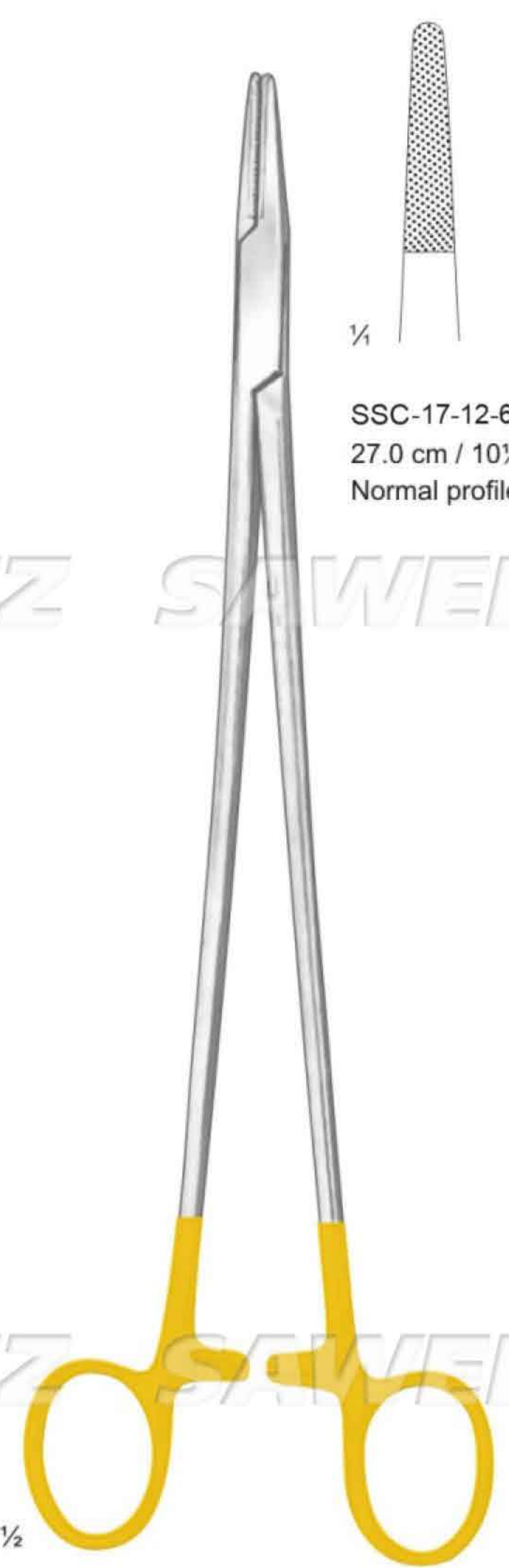


SSC-17-12-69
26.0 cm / 10 1/4"

Micro profile



Ryder-Vascular



SSC-17-12-65
27.0 cm / 10 1/2"
Normal profile

Wangenstein

SAWEEZ SAWEEZ SAWEEZ SAWEEZ

TC / GOLD

SAWEEZ SAWEEZ SAWEEZ SAWEEZ

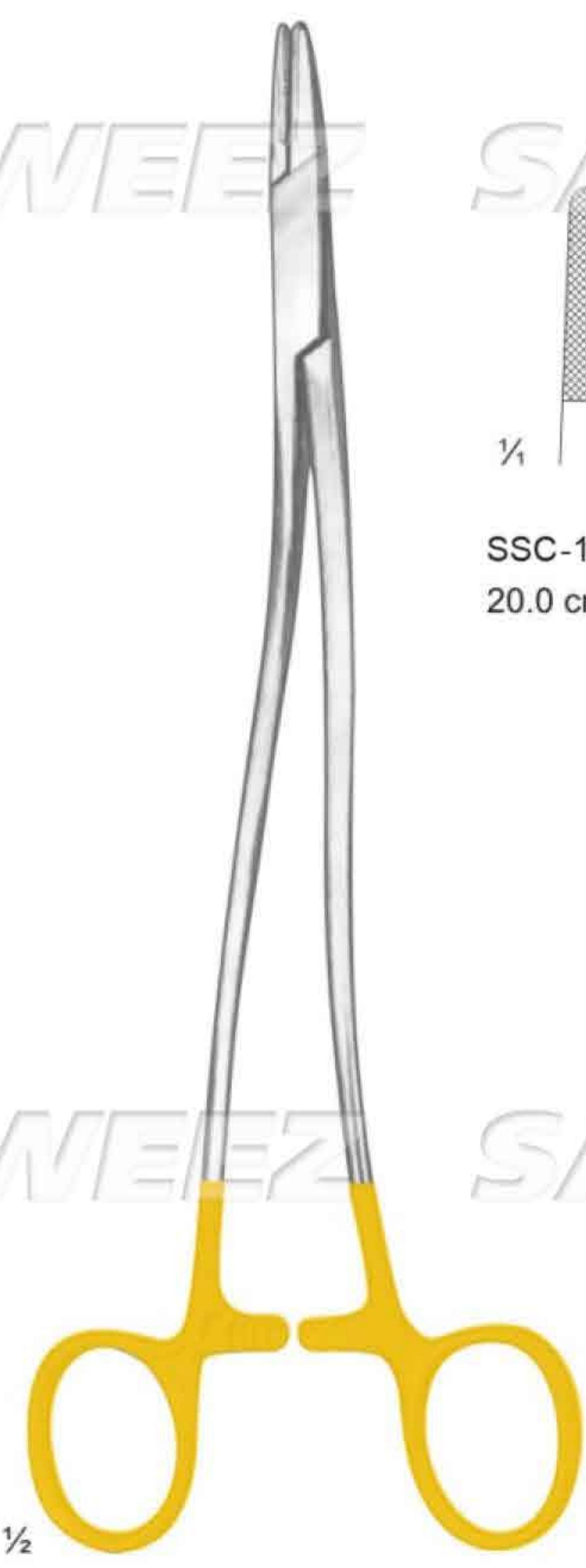





- $\frac{1}{4}$  SSC-17-12-70
14.0 cm / 5½"
- $\frac{1}{4}$  SSC-17-12-71
18.0 cm / 7"
- $\frac{1}{4}$  SSC-17-12-72
20.0 cm / 8"
- $\frac{1}{4}$  SSC-17-12-73
23.0 cm / 9"

Micro profile

Hegar-Vascular

SAWEEZ SAWEEZ SAWEEZ SAWEEZ





- $\frac{1}{4}$  SSC-17-12-74
20.0 cm / 8"
- $\frac{1}{4}$  SSC-17-12-75
24.0 cm / 9½"
- $\frac{1}{4}$  SSC-17-12-76
26.0 cm / 10¼"

Normal profile

Bozemann



- $\frac{1}{4}$  SSC-17-12-77
20.0 cm / 8"
- $\frac{1}{4}$  SSC-17-12-78
24.0 cm / 9½"

Normal profile

Hegar

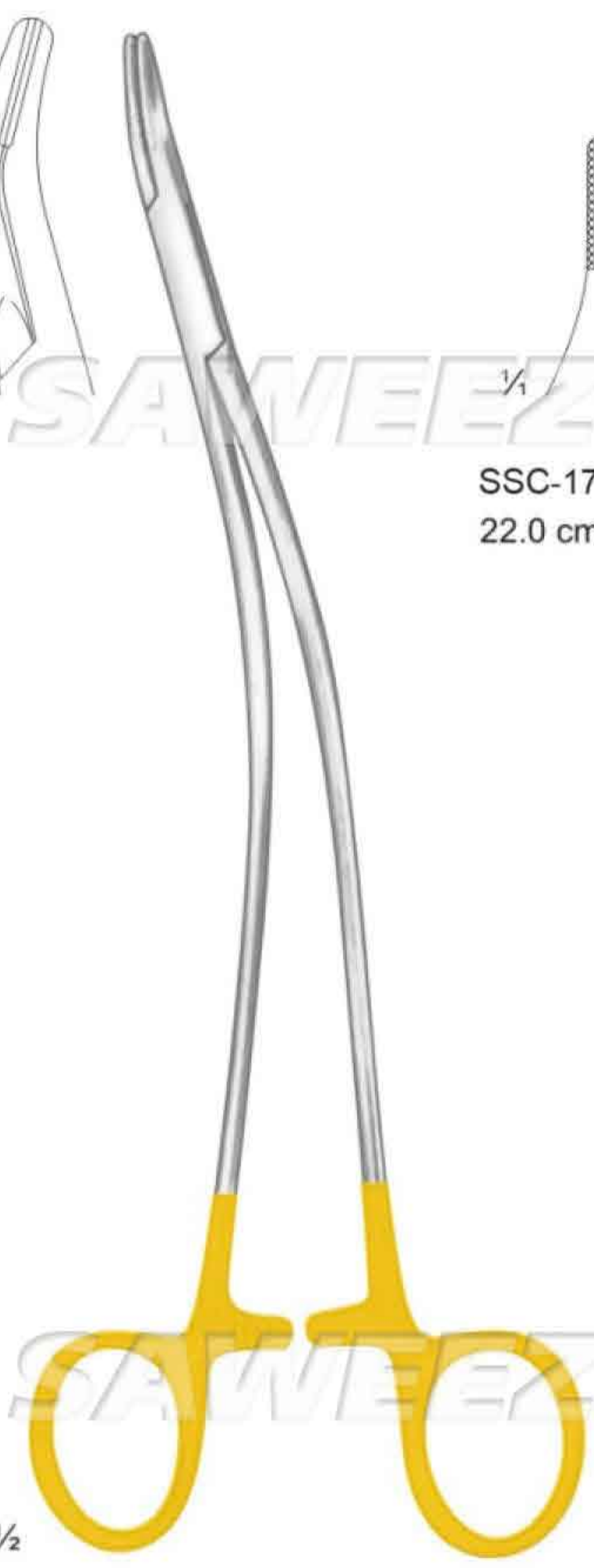
SAWEEZ SAWEEZ SAWEEZ SAWEEZ

TC / GOLD



SSC-17-12-79
22.0 cm / 8 1/2"
SSC-17-12-80
23.0 cm / 9"

Normal profile



Stratte

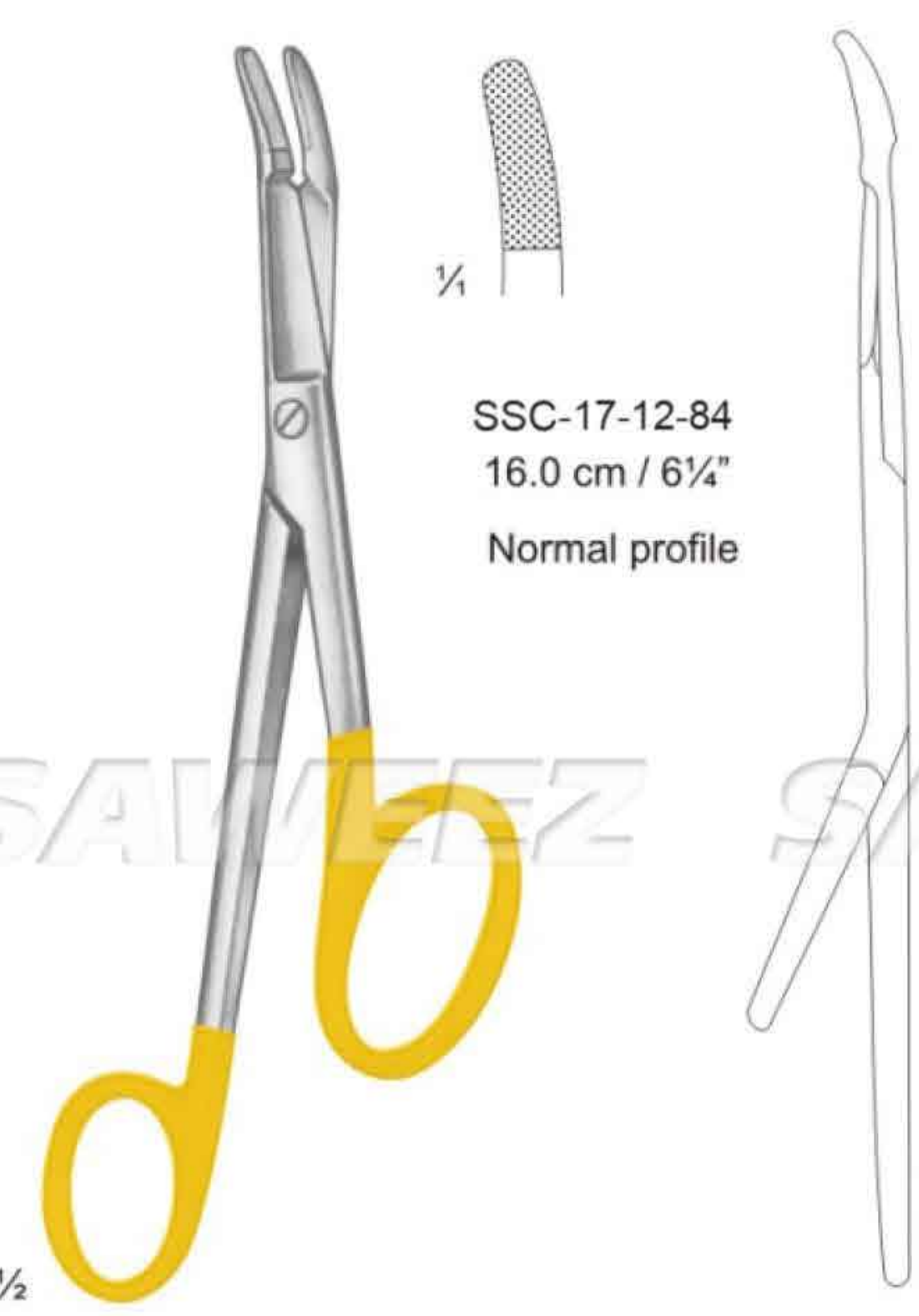


SSC-17-12-81 14.5 cm / 5 1/2"
SSC-17-12-82 16.5 cm / 6 1/2"
SSC-17-12-83 18.0 cm / 7"

Normal profile



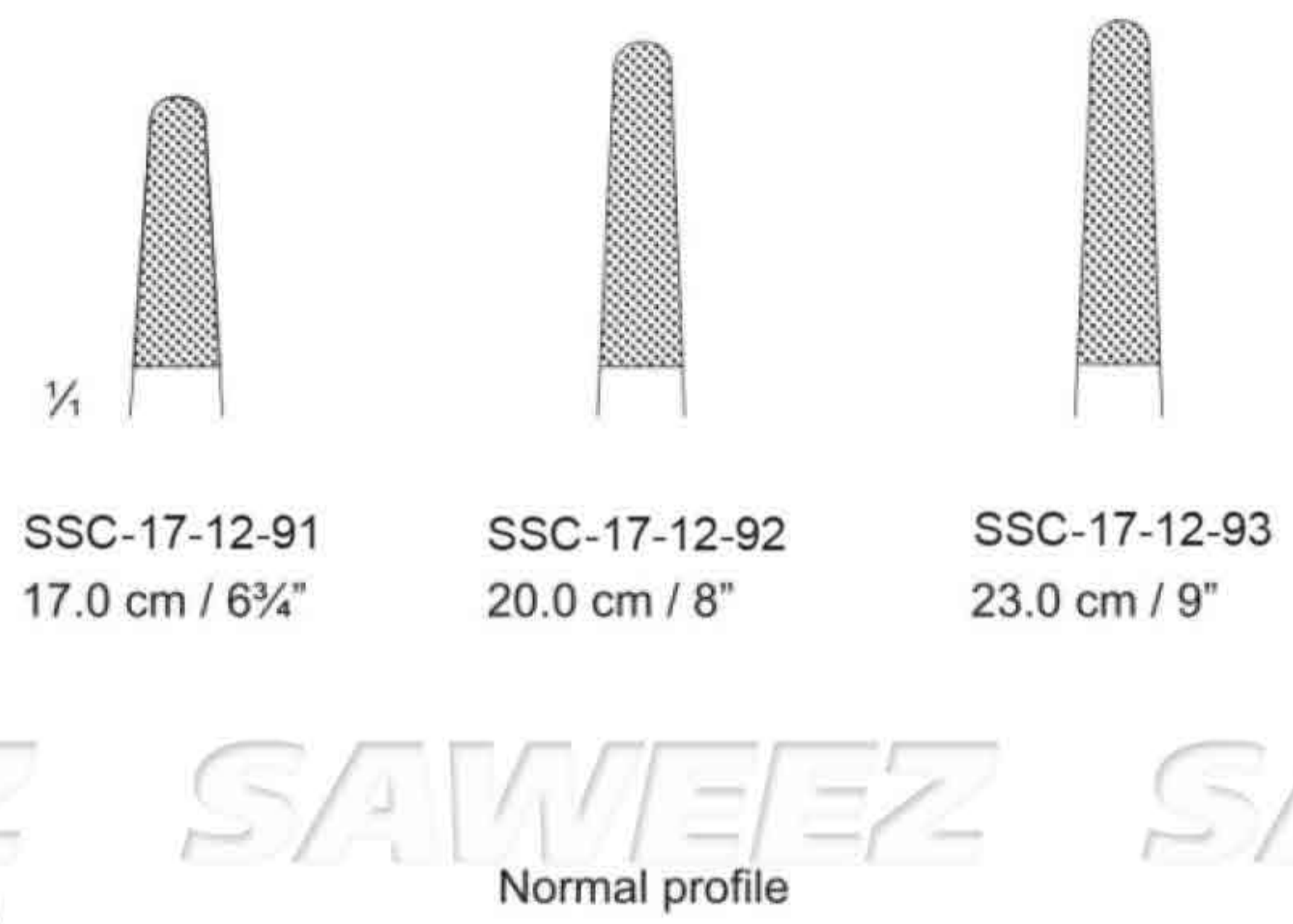
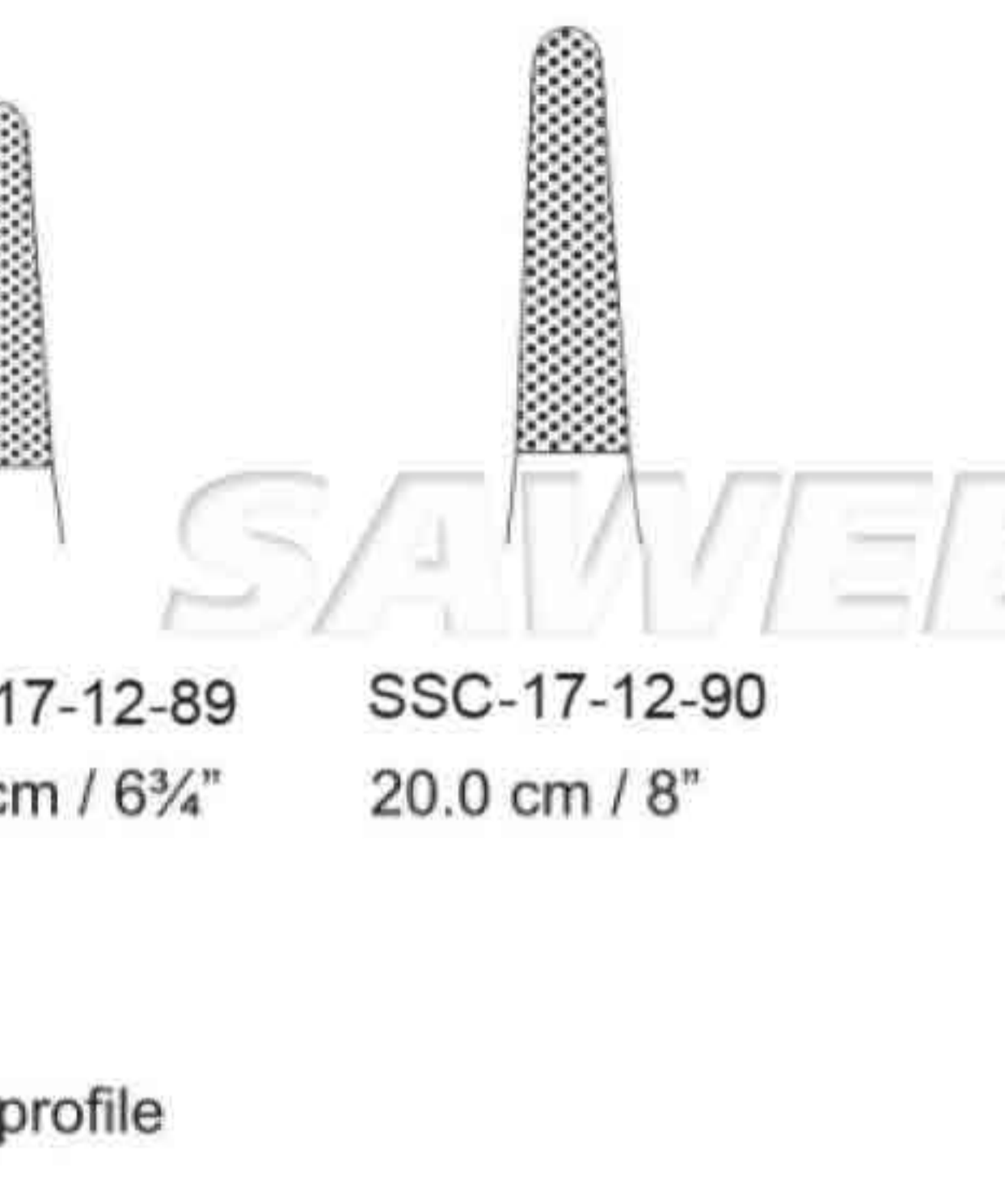
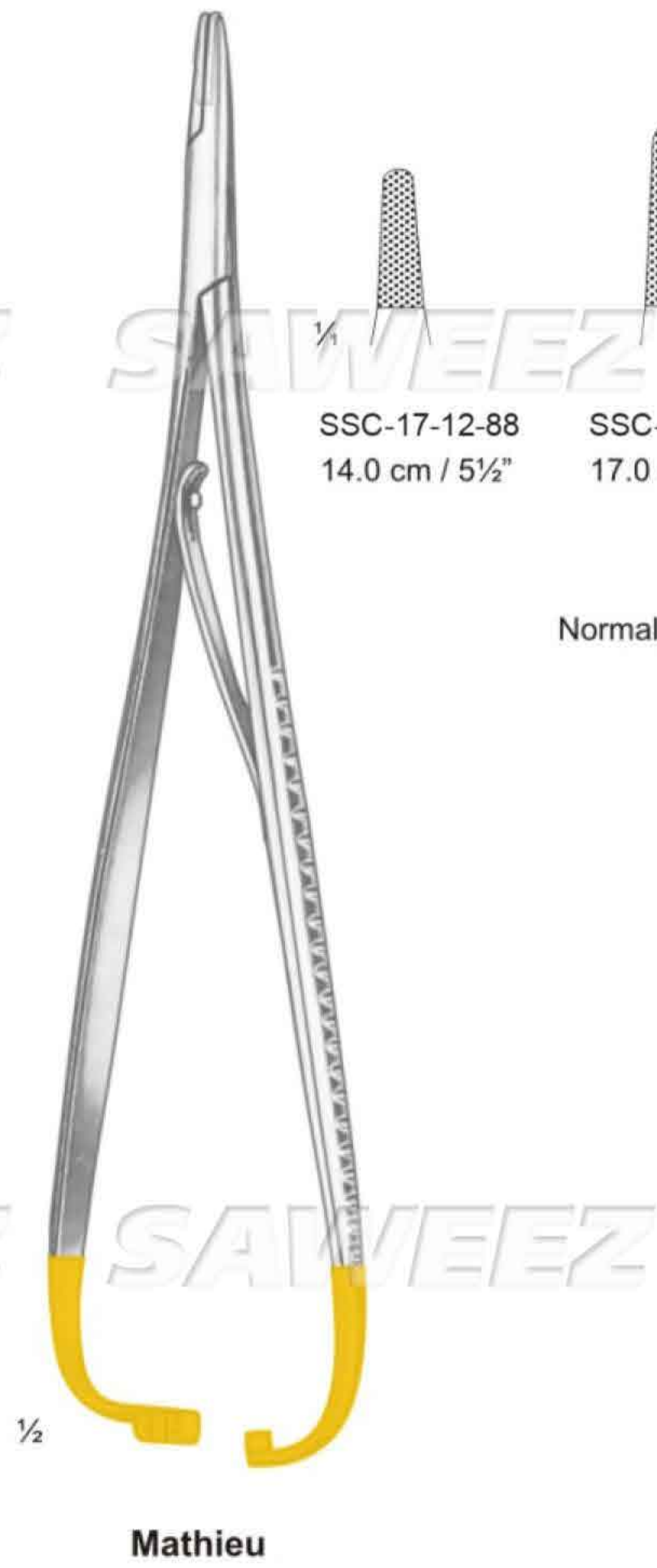
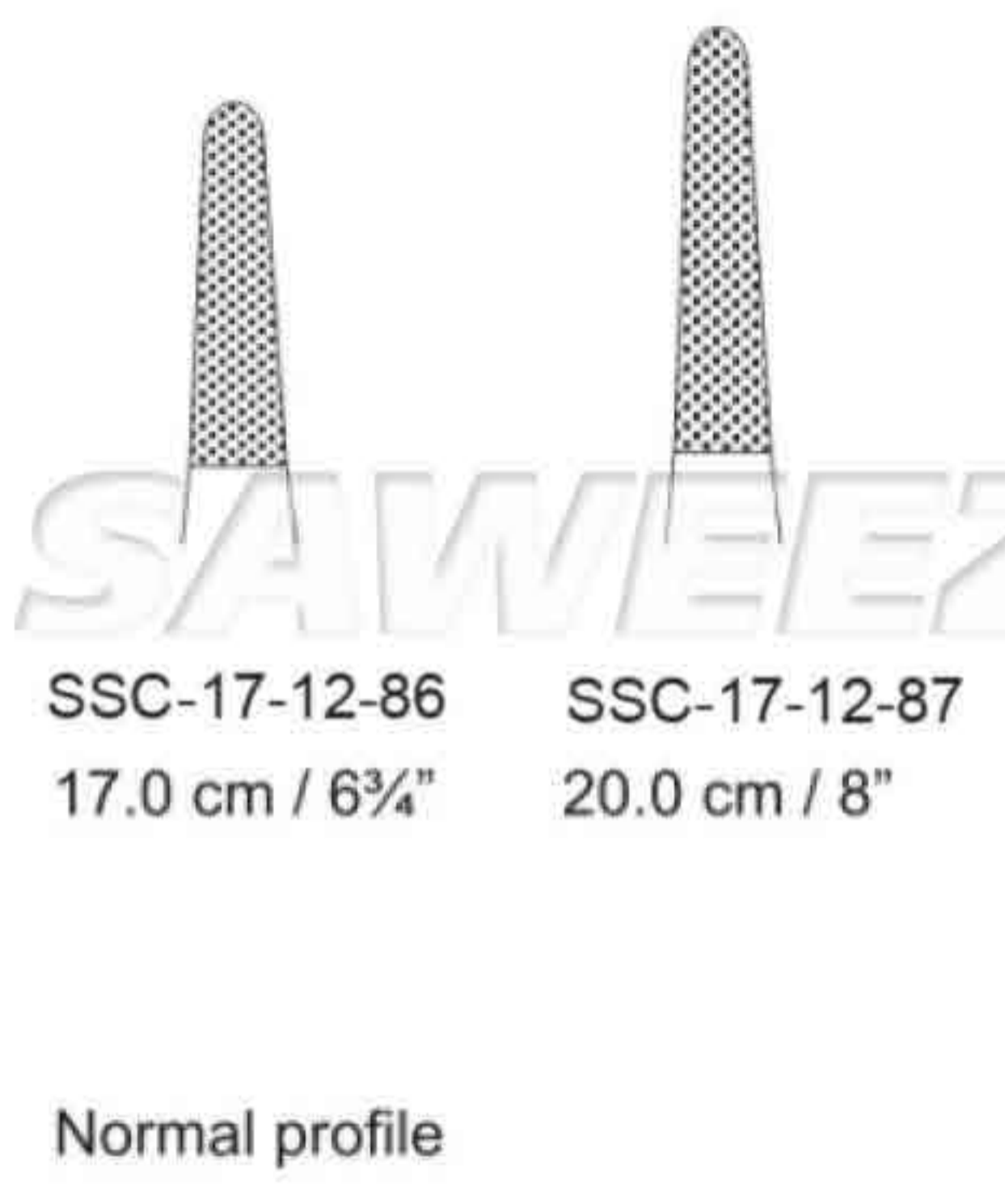
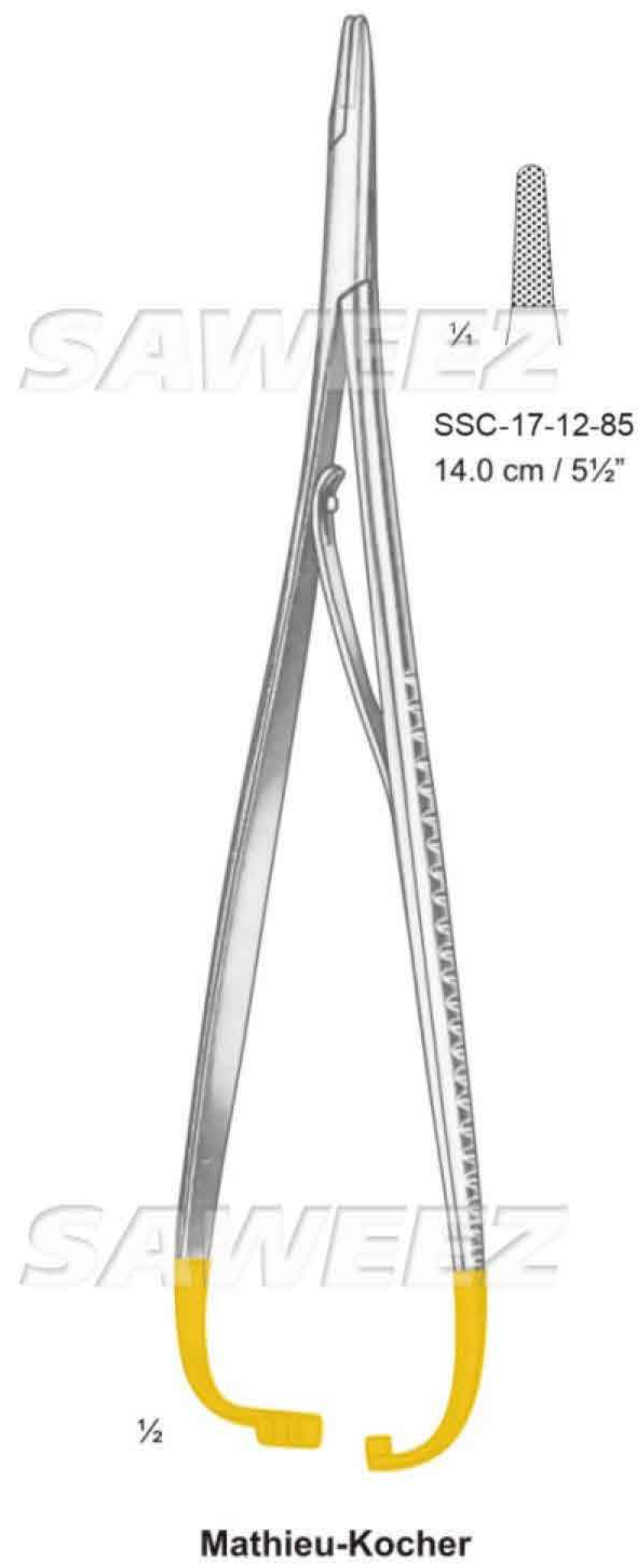
Olsen-Hegar



Gillies

SSC-17-12-84
16.0 cm / 6 1/4"
Normal profile

TC GOLD





TC / GOLD



SAWEEZ

SAWEEZ

SAWEEZ

SAWEEZ

SAWEEZ

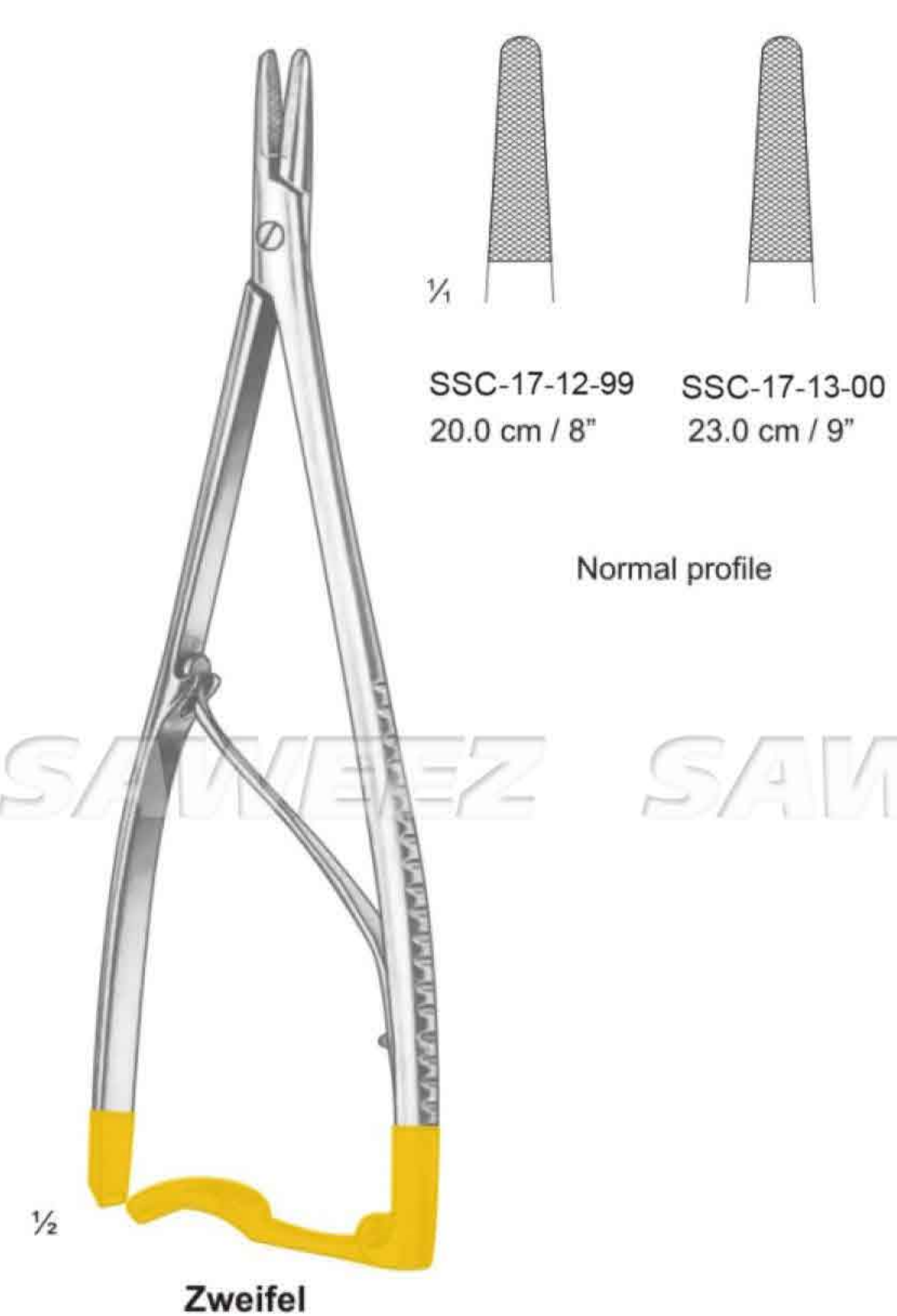
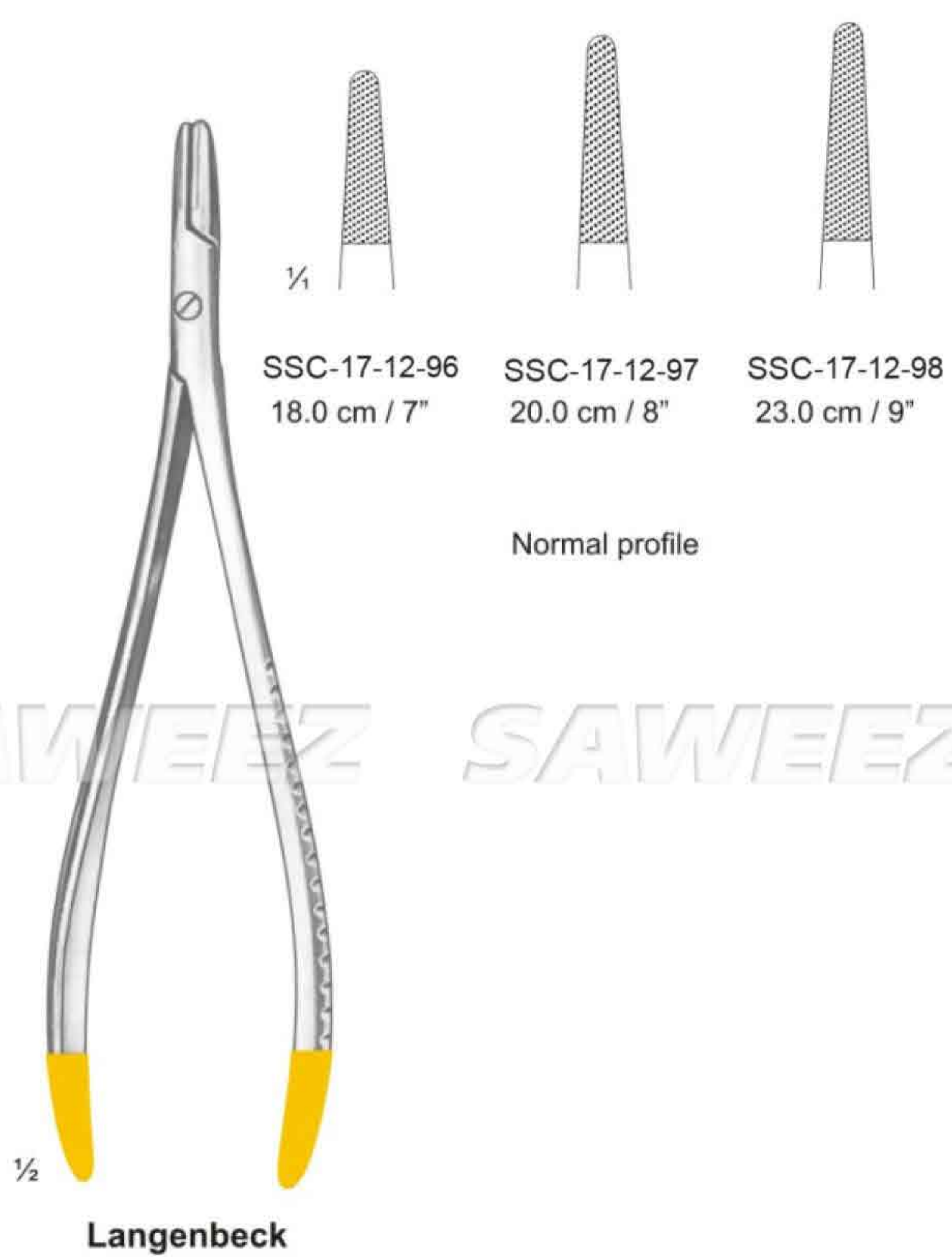
SAWEEZ

SAWEEZ

SAWEEZ

Toennis

Lichtenberg



SAWEEZ

SAWEEZ

SAWEEZ

SAWEEZ



For fingers



Lister

SSC-19-11-11 - 9.0 cm / 3½"
 SSC-19-11-12 - 14.0 cm / 5½"
 SSC-19-11-13 - 18.0 cm / 7"
 SSC-19-11-14 - 20.0 cm / 8"



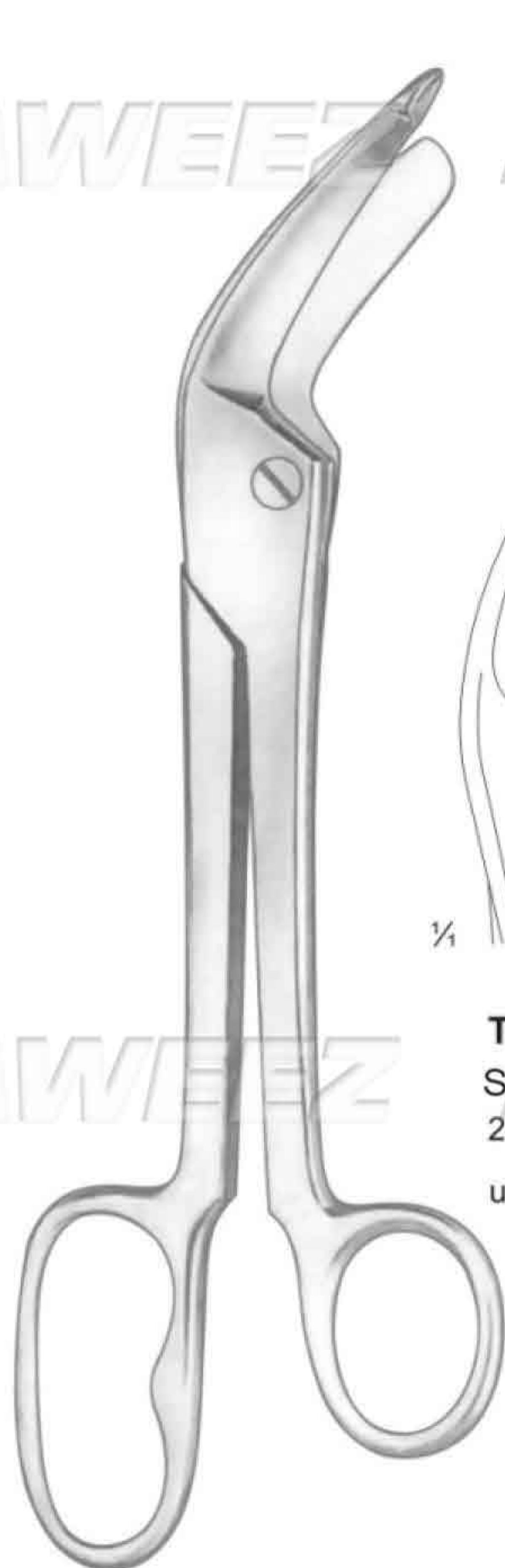
Excentric

SSC-19-11-15 - 16.0 cm / 6¼"
 SSC-19-11-16 - 19.0 cm / 7½"



Knowles

SSC-19-11-17
 14.0 cm / 5½"



Tornado

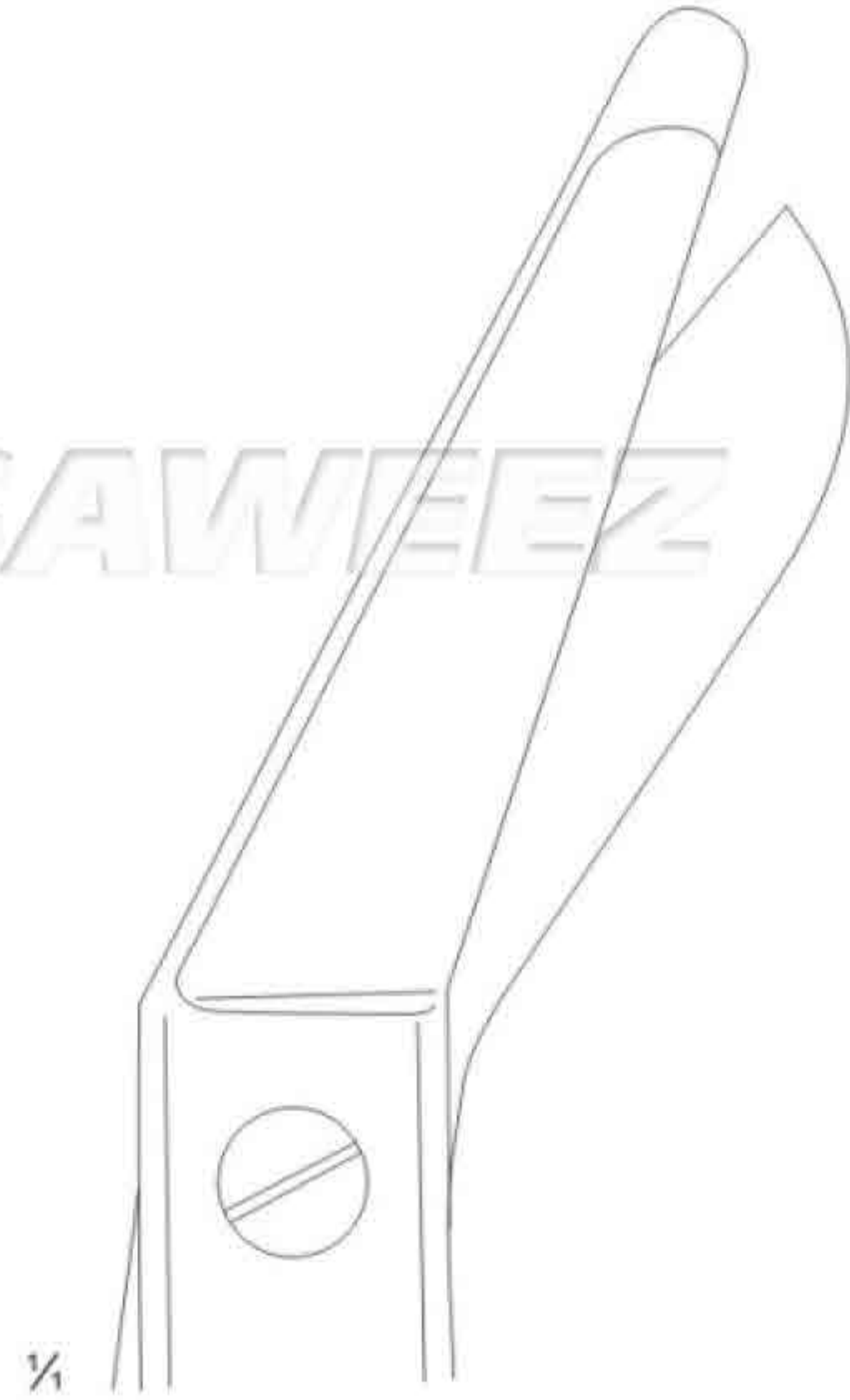
SSC-19-11-18
 24.0 cm / 9½"

undulated cutting edge



Bergmann

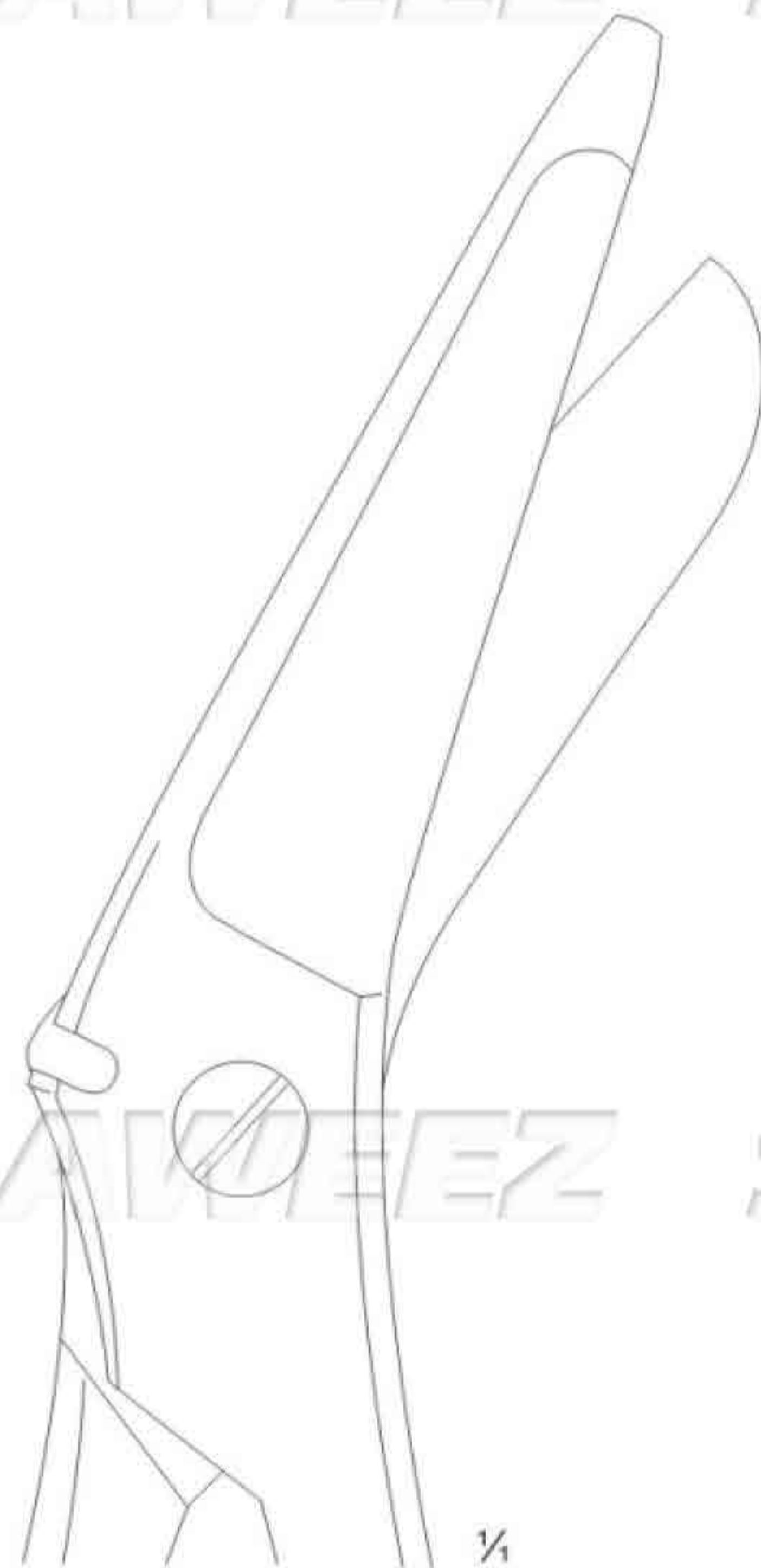
SSC-19-11-19
 23.0 cm / 9"



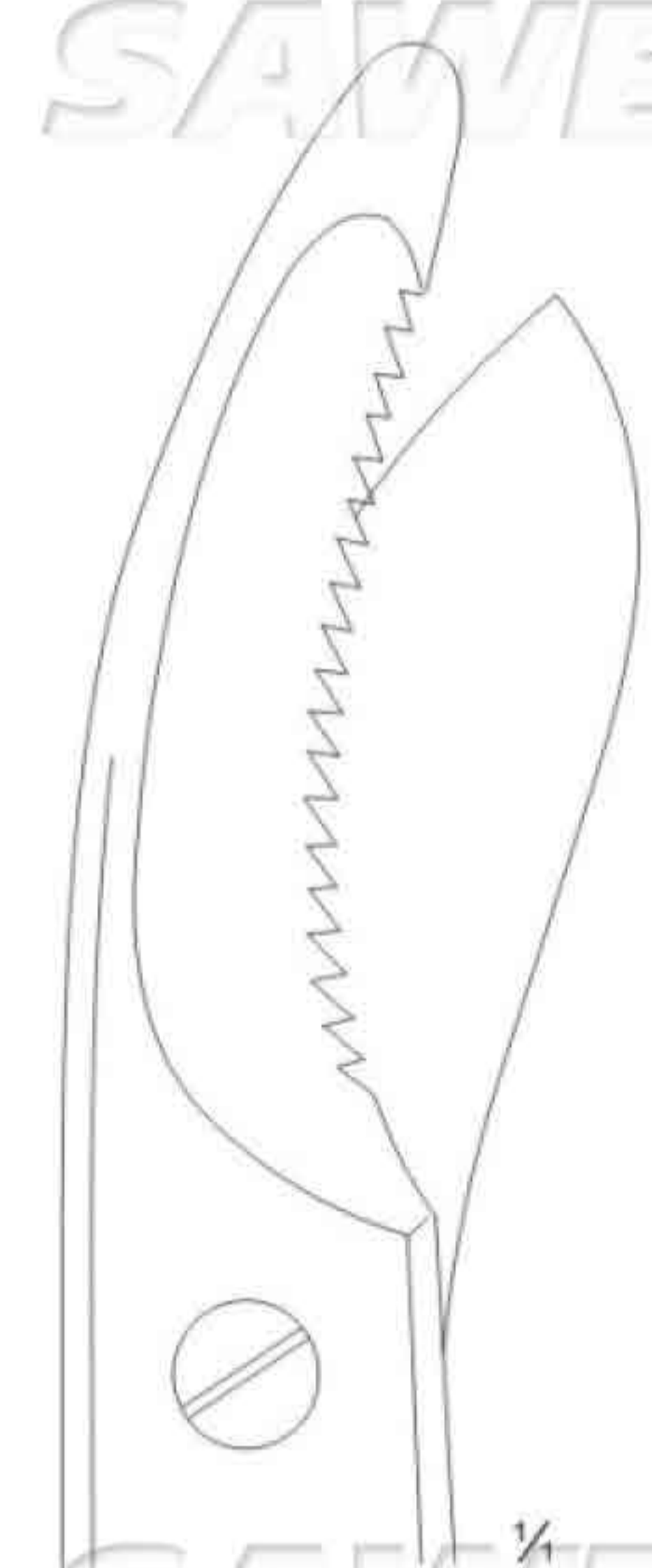
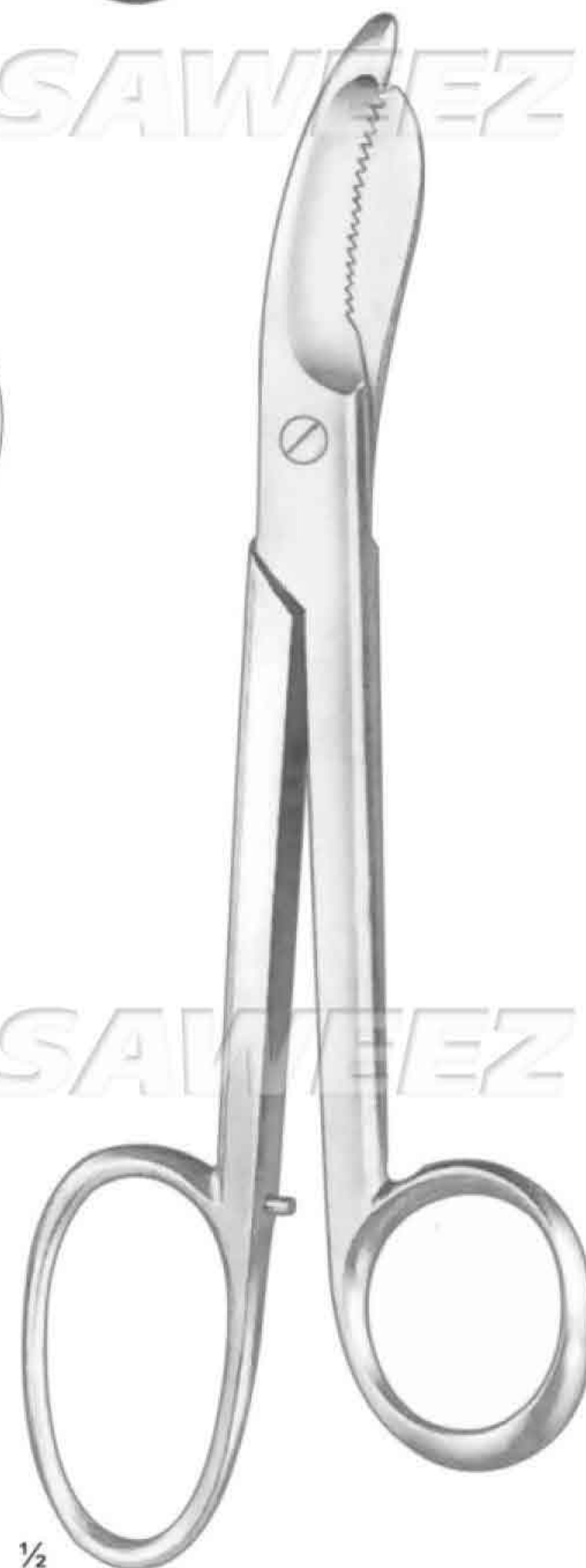
Esmarch
SSC-19-11-20 - 20.0 cm / 8"
SSC-19-11-21 - 22.0 cm / 8 3/4"



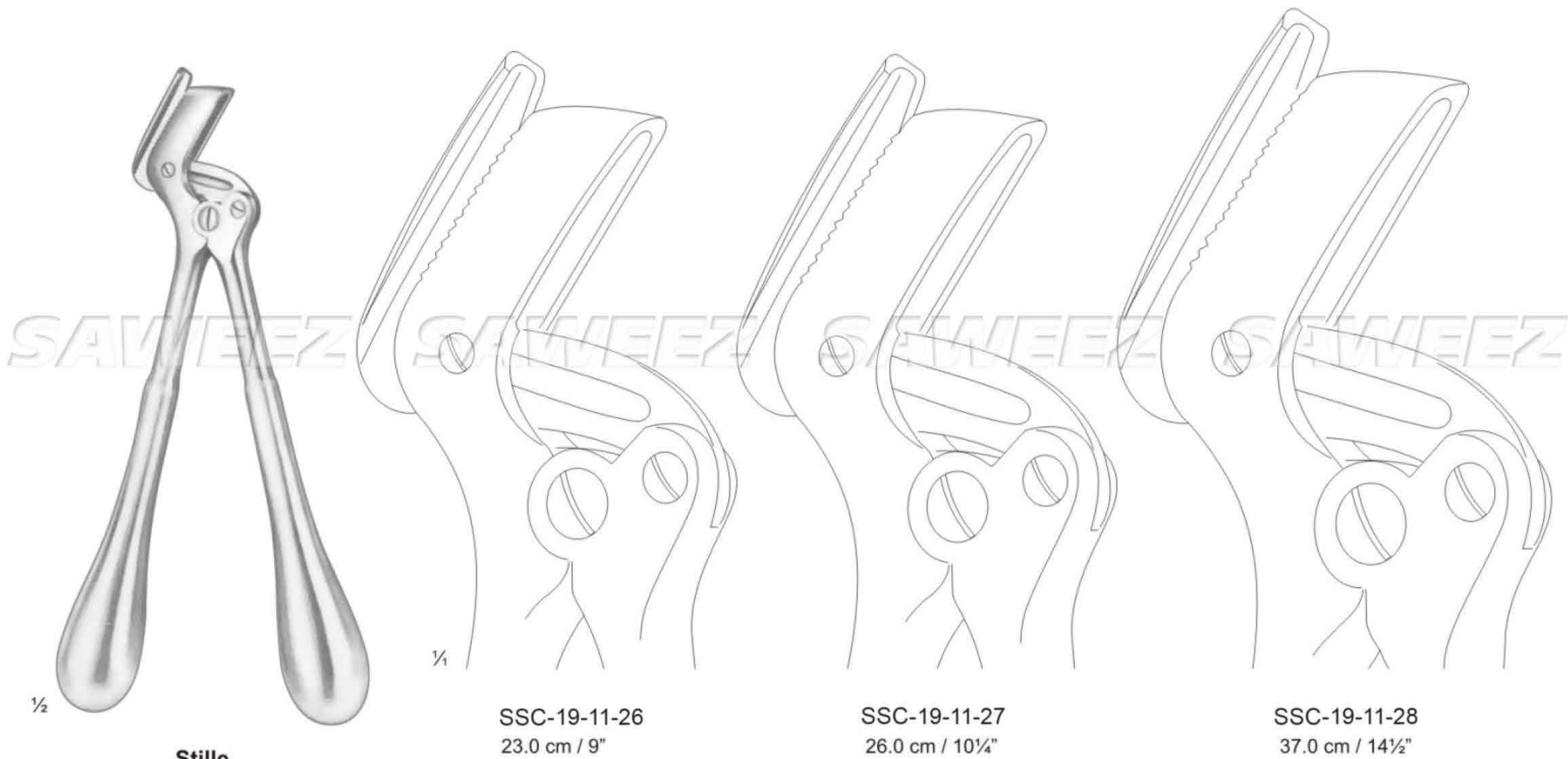
Lister
SSC-19-11-22 - 15.0 cm / 6"
SSC-19-11-23 - 17.0 cm / 7"



SSC-19-11-24
20.0 cm / 8"



Brun's
SSC-19-11-25
24.0 cm / 9 1/2"





1/2

Engel
SSC-19-11-31
14.0 cm / 5 1/2"



1/2

Hopkins
SSC-19-11-32
20.0 cm / 8"



1/2

Esmarch
SSC-19-11-33
18.0 cm / 7"



1/2

Reiner
SSC-19-11-34
18.5 cm / 7 1/4"



1/2

Special Mod. Britton
SSC-19-11-35
21.0 cm / 8 1/4"



Henning



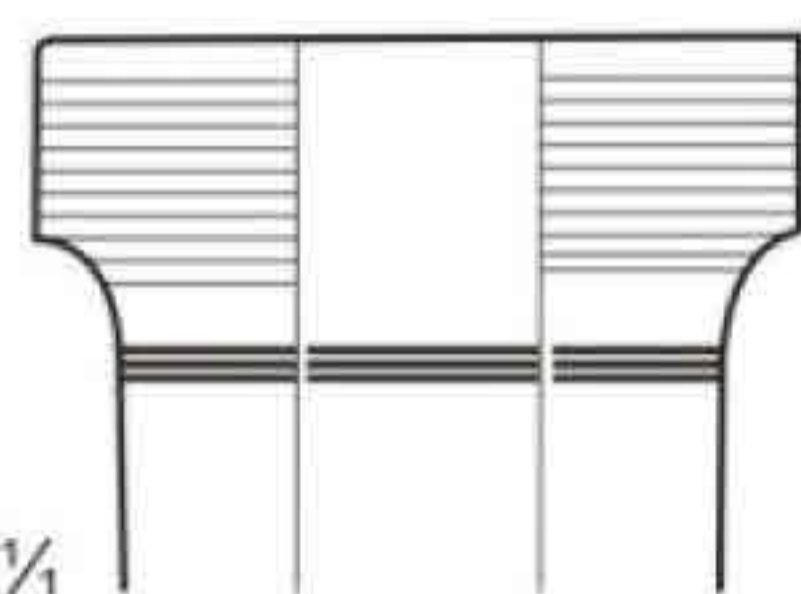
1/4

SSC-19-11-36
28.0 cm / 11"

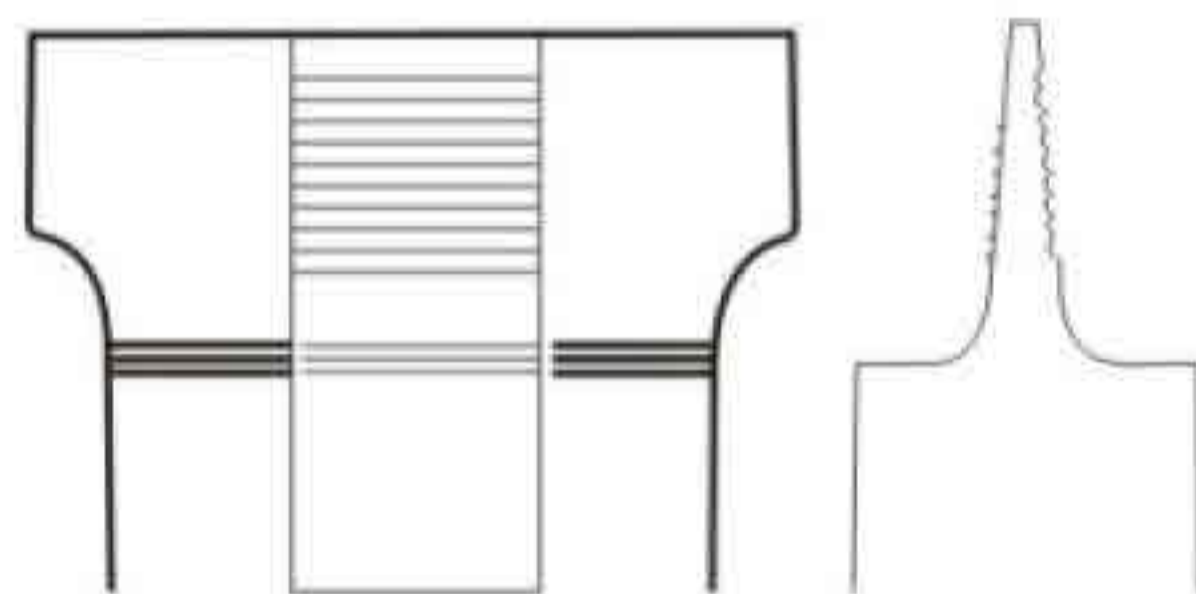
1/2

SAWEEZ SAWEEZ SAWEEZ SAWEEZ

SAWEEZ SAWEEZ SAWEEZ SAWEEZ

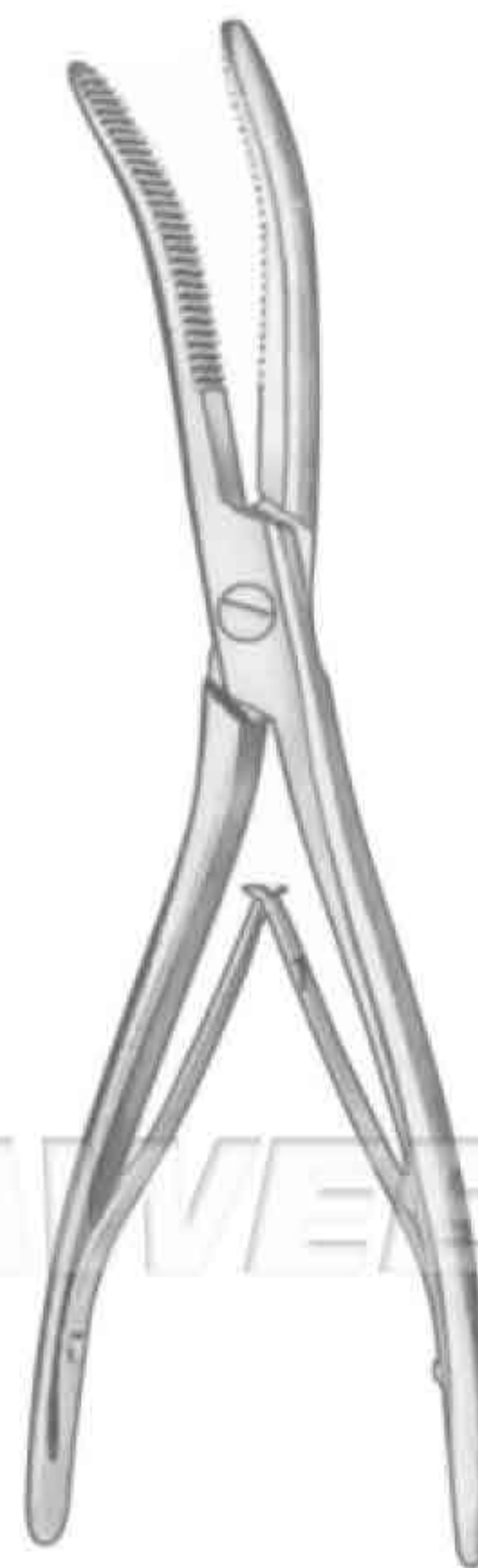


1/4

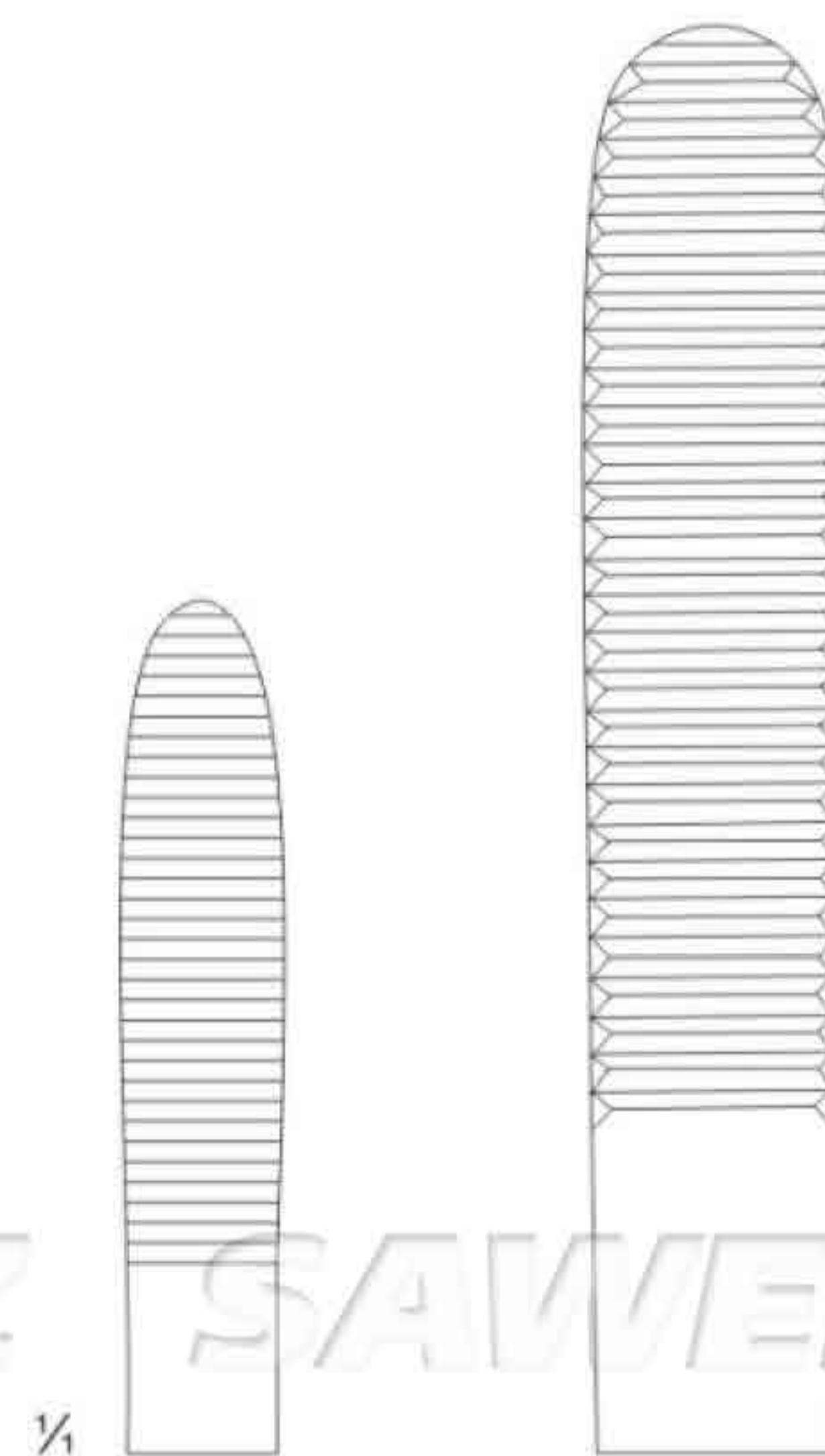


1/2

SSC-19-11-37
23.0 cm / 9"



Wolff

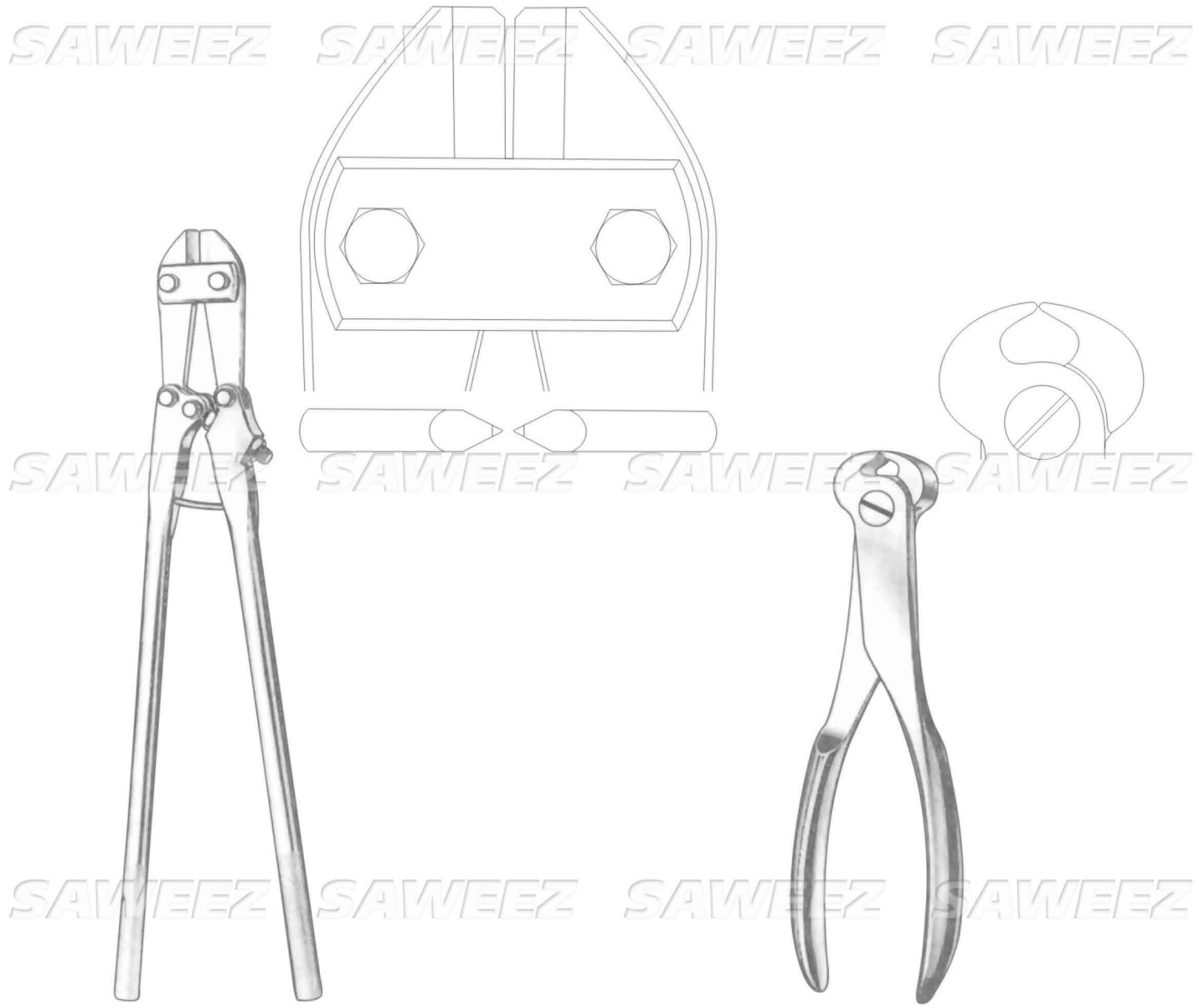


1/4

SSC-19-11-38
18.0 cm / 7"

SSC-19-11-39
24.0 cm / 9 1/2"

SAWEEZ SAWEEZ SAWEEZ SAWEEZ



Large Pin Cutter
SSC-21-11-11
55.6 cm / 22
cut rods up to .250" (6.3mm),
toggle joint transfers leverage to the cutting blades

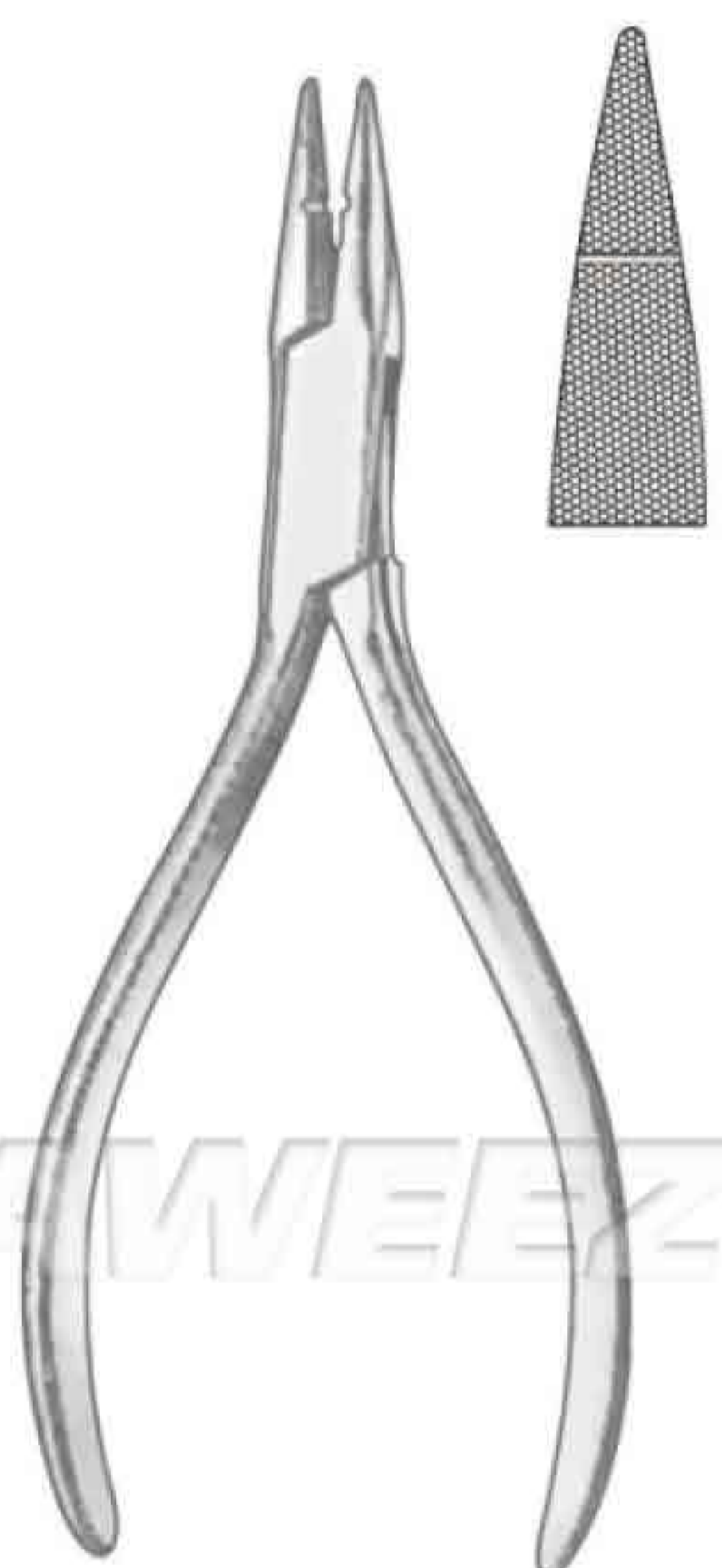
Cannulated Pin Cutter
SSC-21-11-12
19.0 cm / 7½", end cutting
maximum .062" (1.6mm)



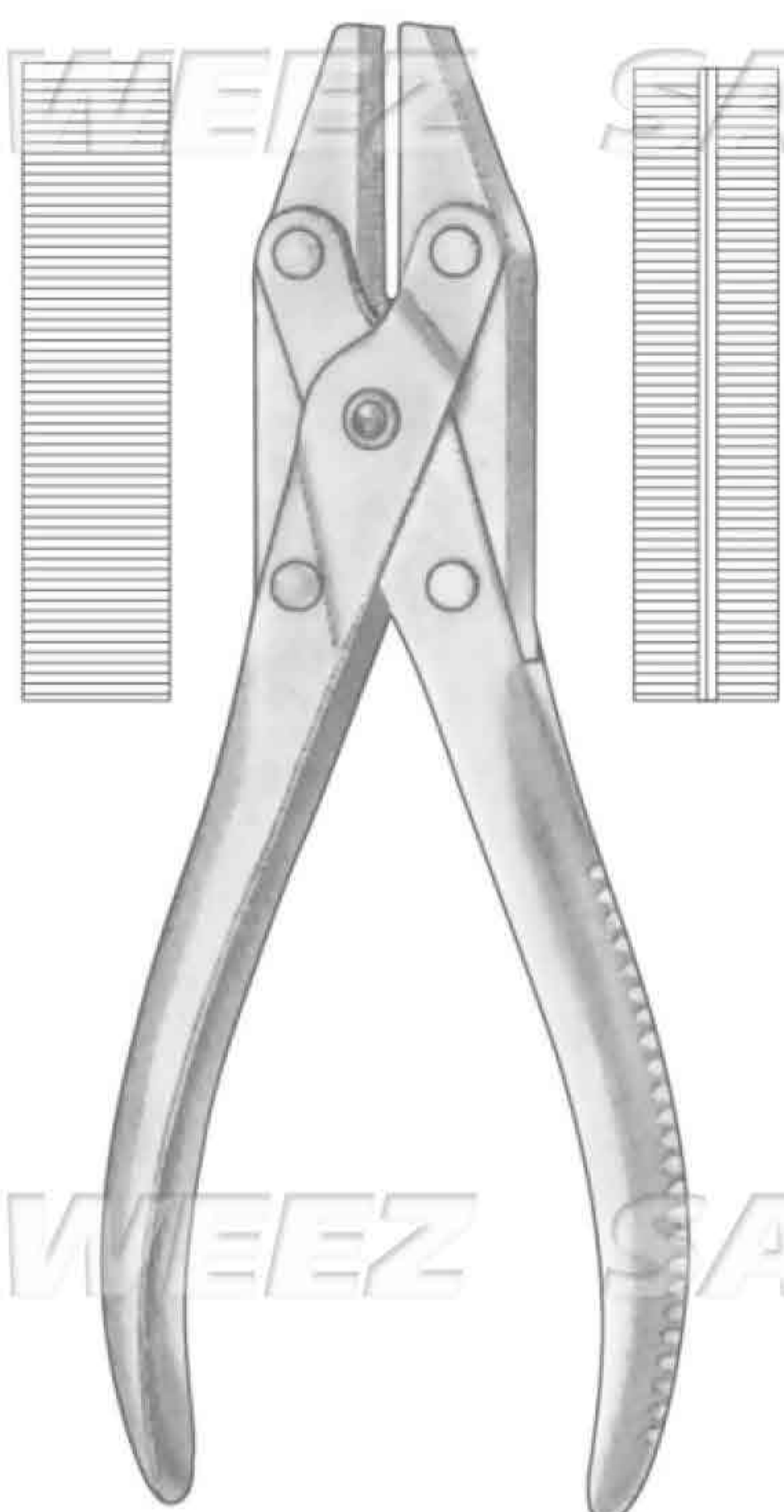
SAWEEZ SAWEEZ SAWEEZ SAWEEZ

SAWEEZ SAWEEZ SAWEEZ SAWEEZ

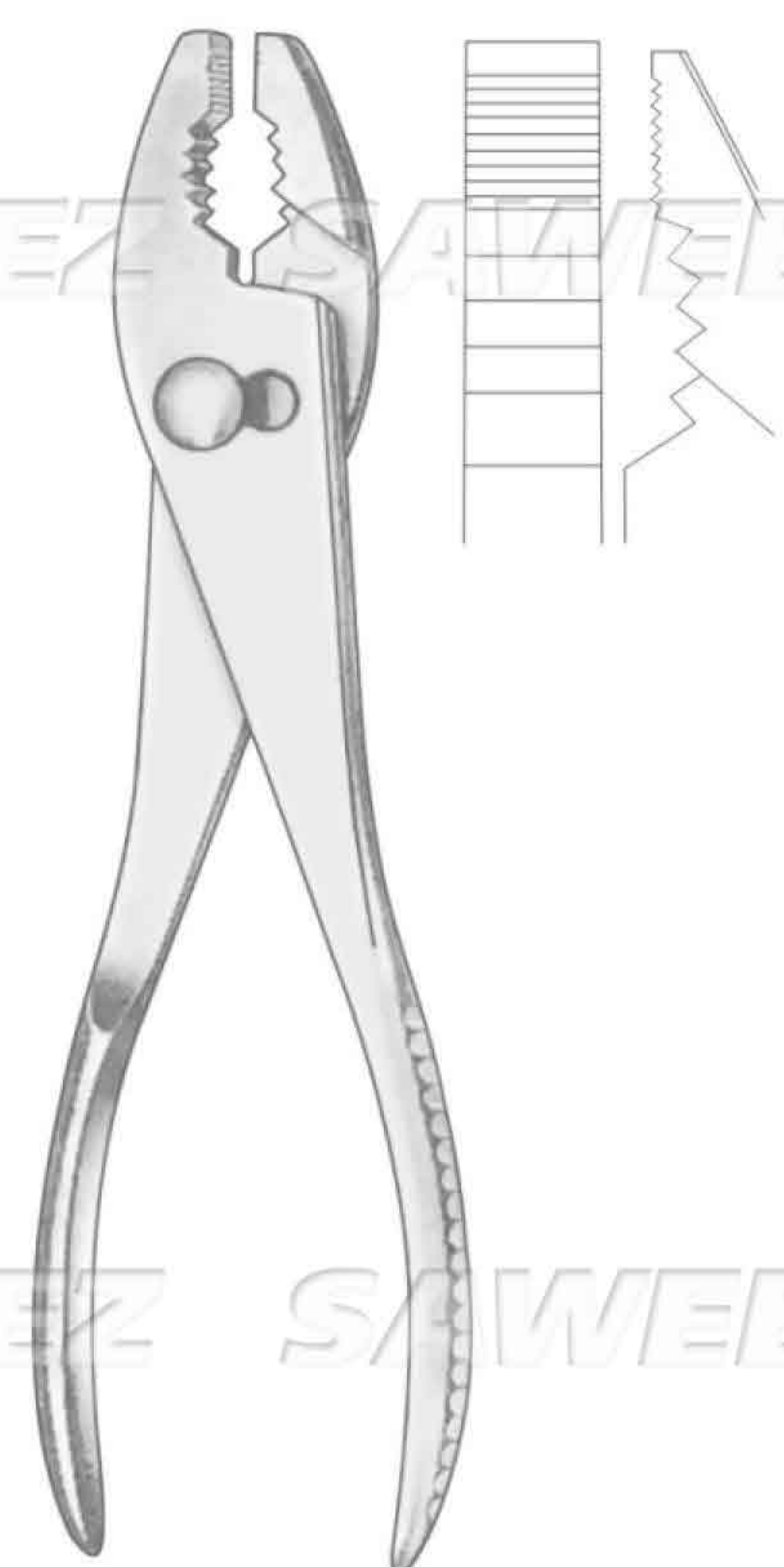
SAWEEZ SAWEEZ SAWEEZ SAWEEZ



Needle Nose Pliers
SSC-21-11-13
14.0 cm / 5½", grooved jaws,
tips taper to 1mm



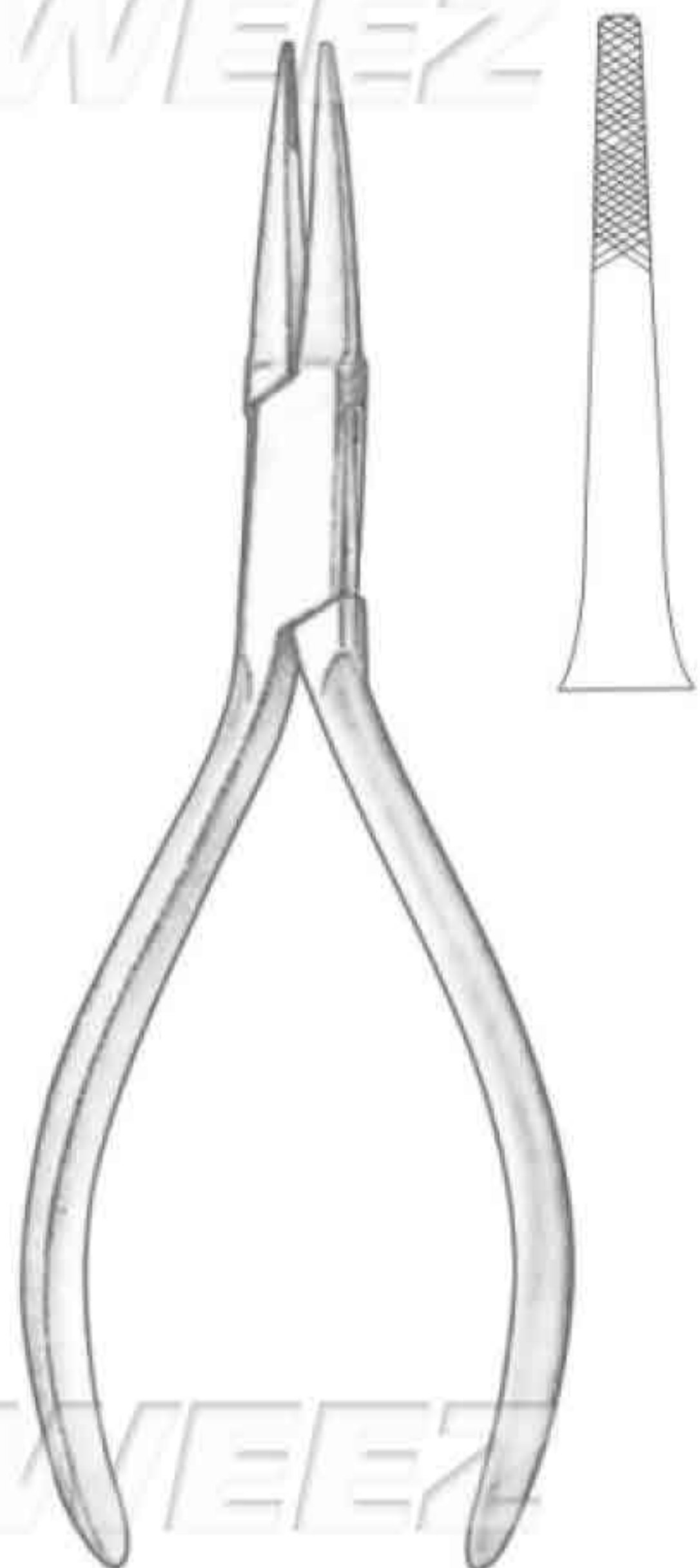
Parallel Pliers
SSC-21-11-14
18.0 cm / 7", grooved 10 mm wide jaws
for pin removal



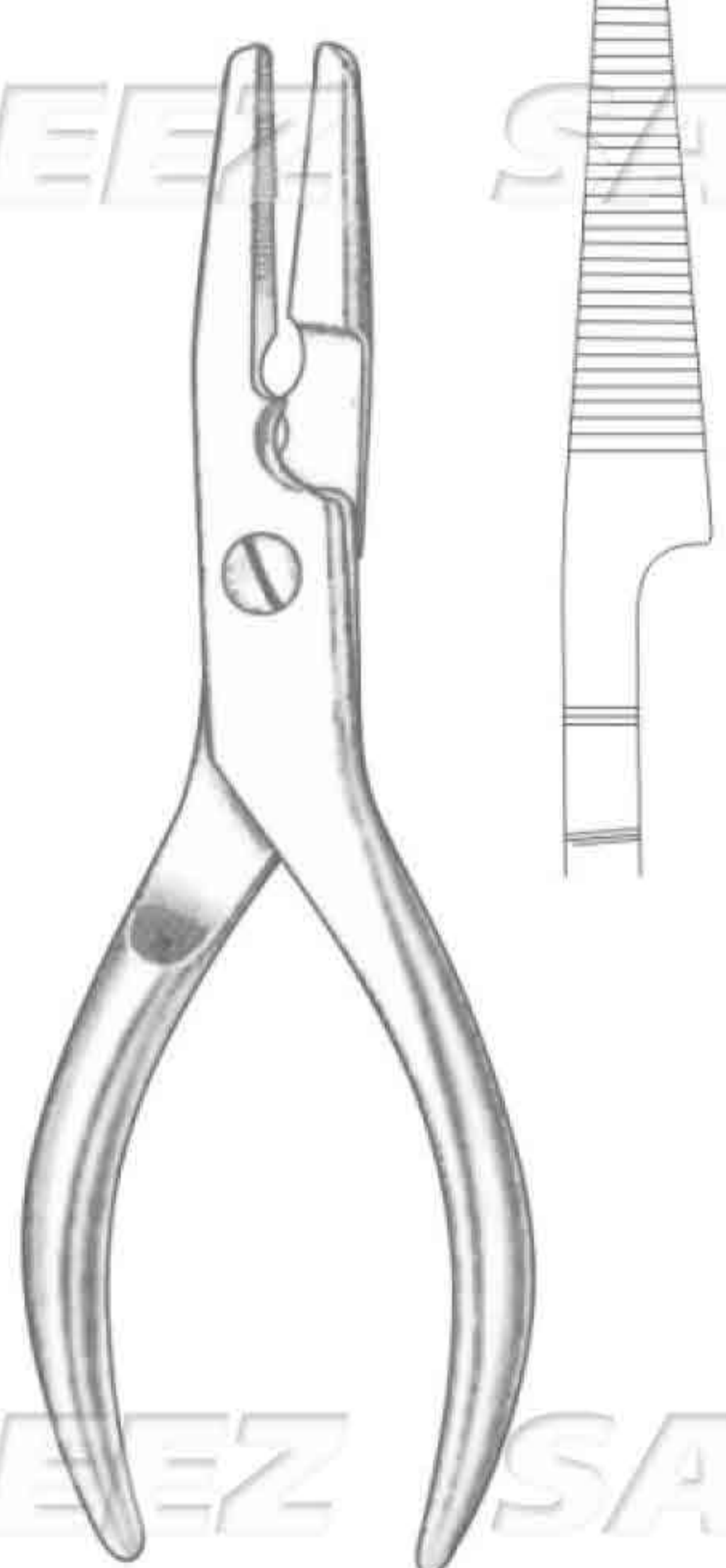
Slip Joint Adjustable Pliers
SSC-21-11-15
19.7 cm / 7¾"



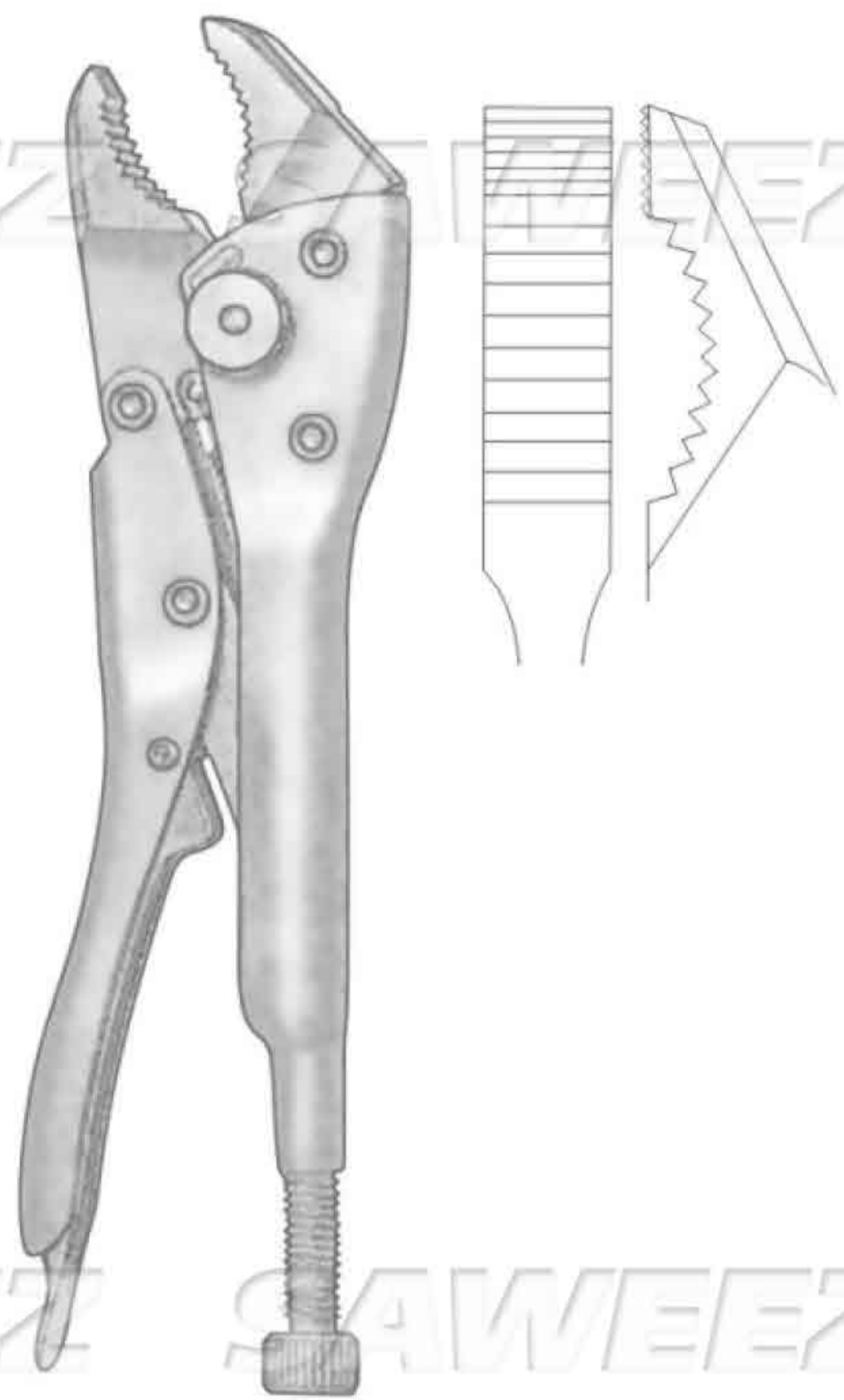
SAWEEZ SAWEEZ SAWEEZ SAWEEZ



Flat Nose Pliers
SSC-21-11-16
15.0 cm / 6", tips taper to 2mm



Flat Nose Pliers
SSC-21-11-17
16.5 cm / 6½", side cutting blades
tips taper to 3.5 mm

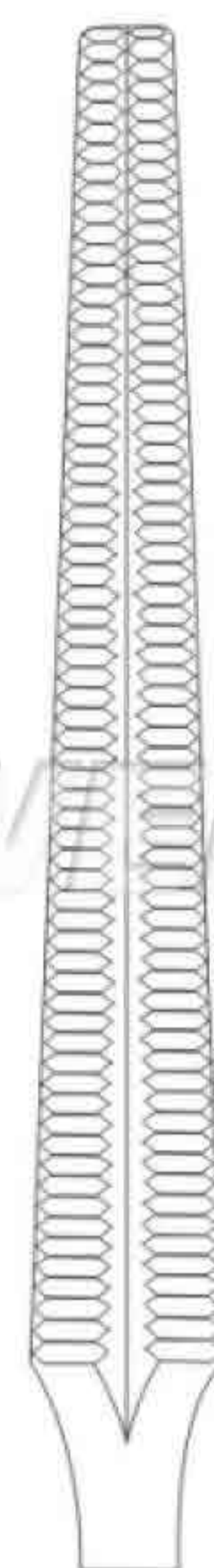
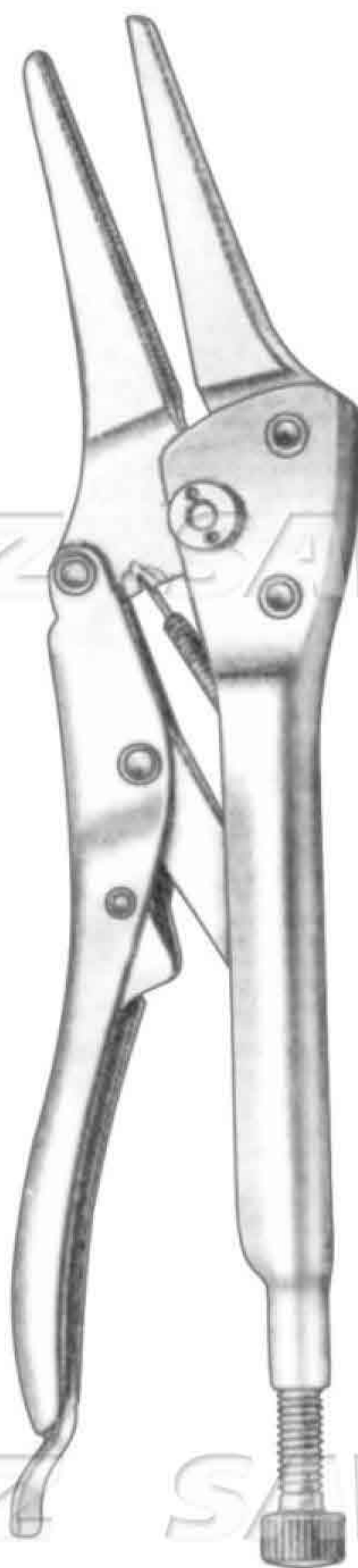
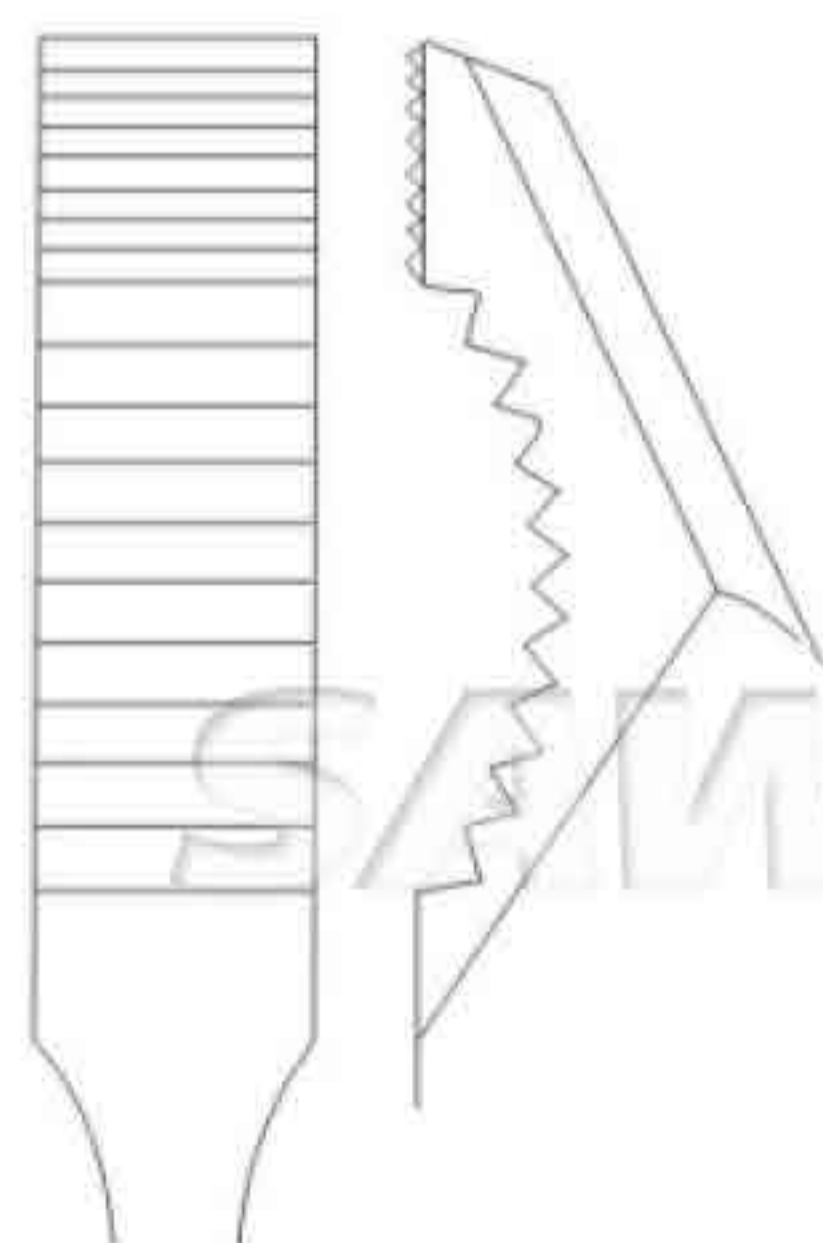
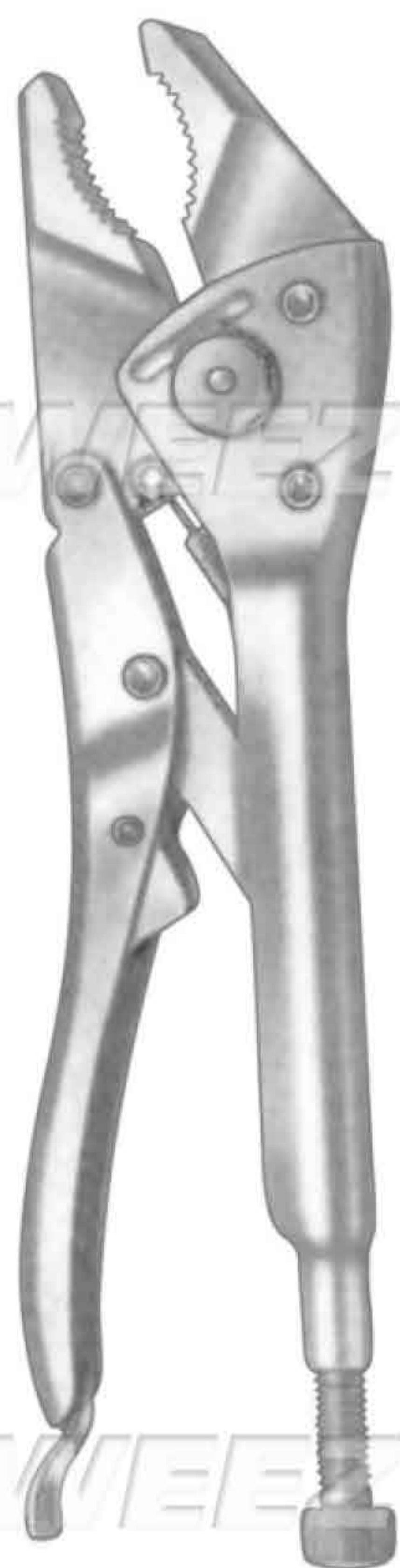


Heavy Duty Locking Pliers
SSC-21-11-18
17.0 cm / 6¾" 7mm wide tip
reinforced jaw hinge, self-locking lever with
adjustment screw and one-handed quick release

SAWEEZ SAWEEZ SAWEEZ SAWEEZ



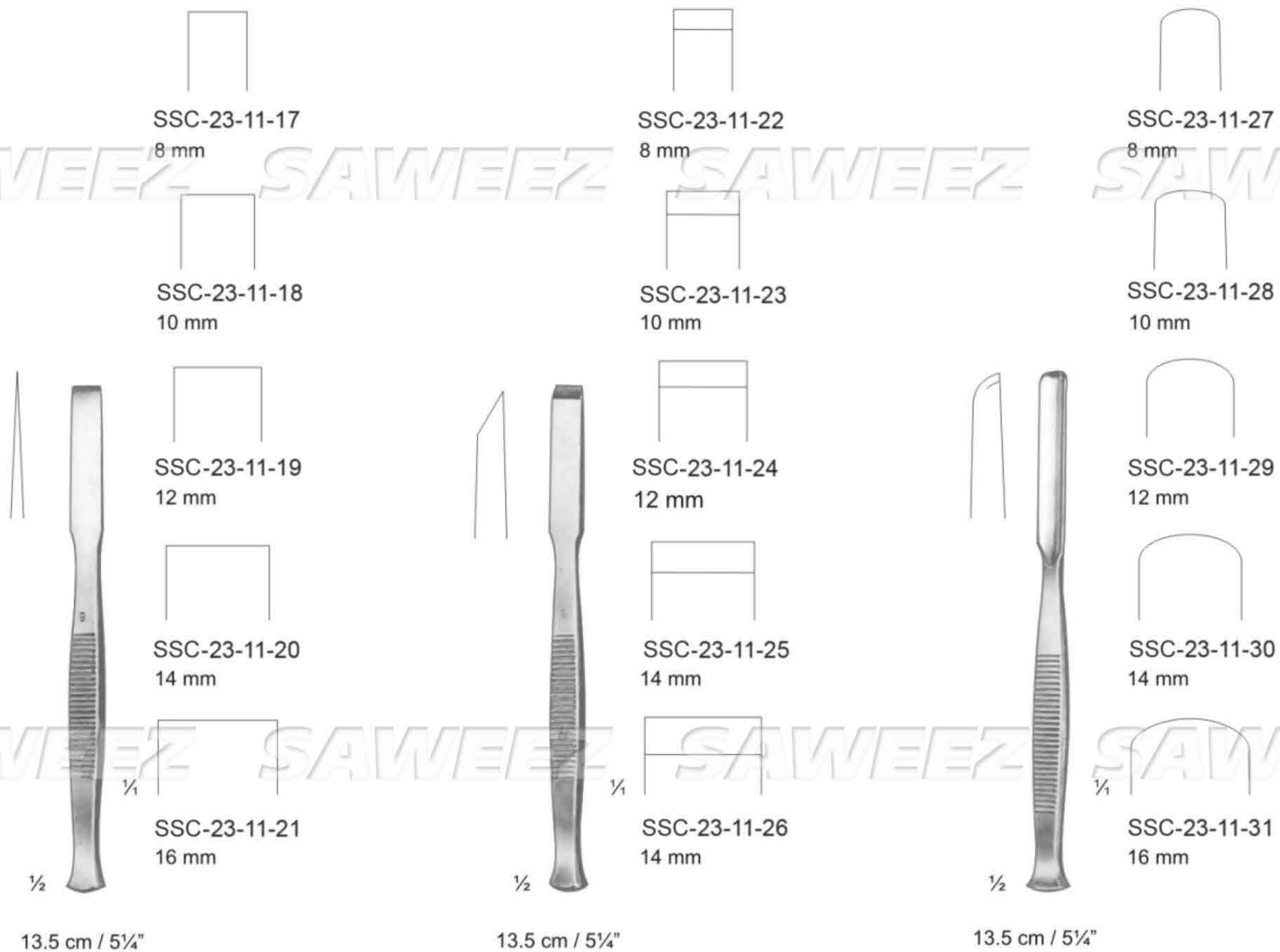
SAWEEZ SAWEEZ SAWEEZ SAWEEZ

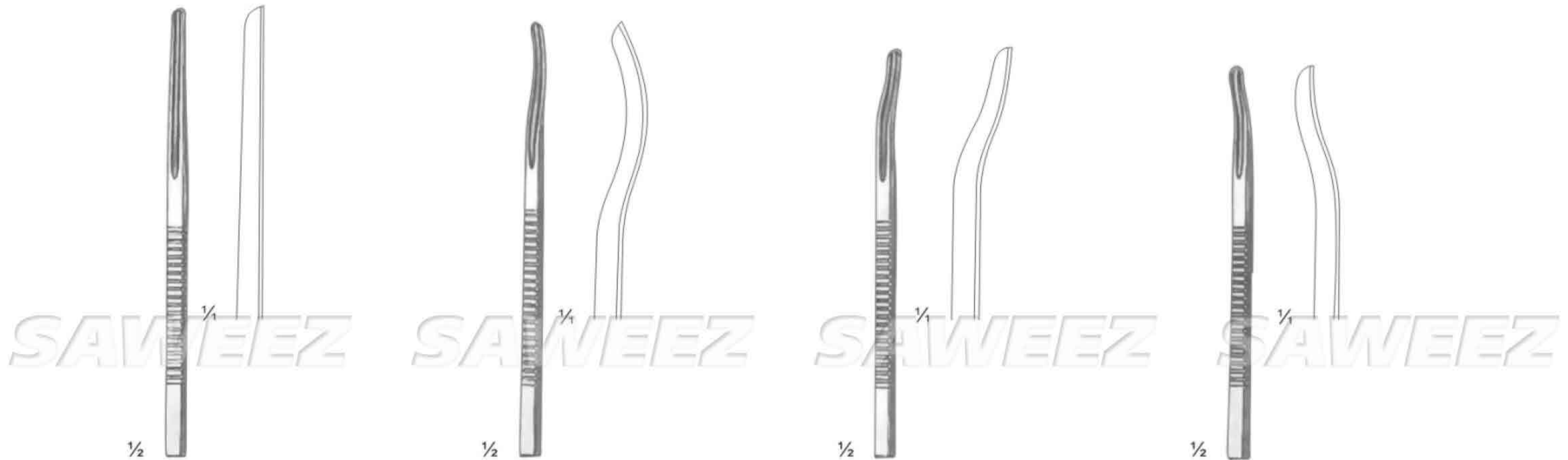


Heavy Duty Locking Pliers
SSC-21-11-19
20.0 cm / 8" 9mm wide tip
reinforced jaw hinge,
self-locking lever with adjustment
screw and one-handed quick release

Heavy Duty Locking Pliers
SSC-21-11-20
24.0 cm / 9½" 5mm wide tip
reinforced jaw hinge,
self-locking lever with
adjustment screw and
one-handed quick release

Townley Femur Caliper
SSC-21-11-21
11.5 cm / 4½"





Buck-Gramcko
SSC-23-11-32
11.0 cm / 4½"

SSC-23-11-33
11.0 cm / 4½"

SSC-23-11-34
10.0 cm / 4"

SSC-23-11-35
10.0 cm / 4"

13.5 cm / 5¼" 17.0 cm / 6¾"

13.5 cm / 5¼" 17.0 cm / 6¾"

SSC-23-11-56
4 mm

SSC-23-11-62
4 mm



SSC-23-11-36 2 mm
SSC-23-11-41 2 mm

SSC-23-11-46 2 mm
SSC-23-11-51 2 mm

SSC-23-11-57 6 mm

SSC-23-11-63 6 mm

SSC-23-11-37 3 mm
SSC-23-11-42 3 mm

SSC-23-11-47 3 mm
SSC-23-11-52 3 mm

SSC-23-11-58 8 mm

SSC-23-11-64 8 mm

SSC-23-11-38 4 mm
SSC-23-11-43 4 mm

SSC-23-11-48 4 mm
SSC-23-11-53 4 mm

SSC-23-11-59 10 mm

SSC-23-11-65 10 mm



SSC-23-11-39 5 mm
SSC-23-11-44 5 mm

SSC-23-11-49 5 mm
SSC-23-11-54 5 mm

SSC-23-11-60 12 mm

SSC-23-11-66 12 mm

SSC-23-11-40 6 mm
SSC-23-11-45 6 mm

SSC-23-11-50 6 mm
SSC-23-11-55 6 mm

SSC-23-11-61 14 mm

SSC-23-11-67 14 mm



Partsch

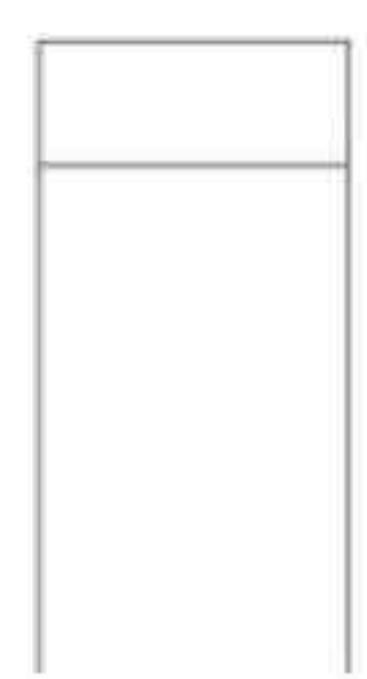


Alexander
18.0 cm / 7"





SAWEEZ SAWEEZ SAWEEZ SAWEEZ



SSC-23-11-68
10 mm



SSC-23-11-72
10 mm



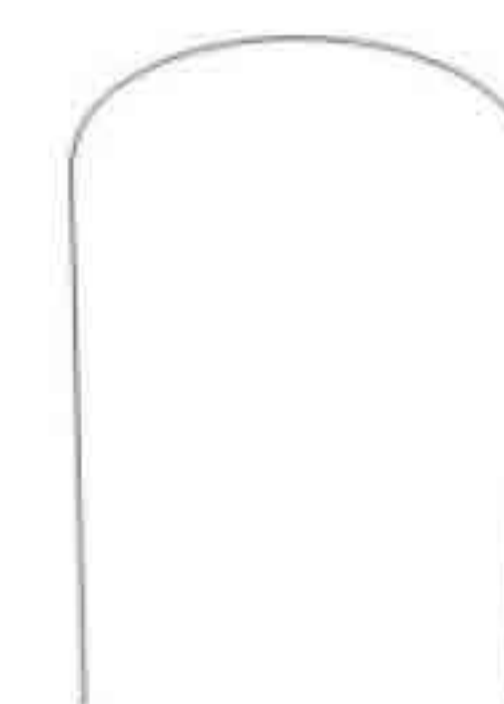
SSC-23-11-76
10 mm



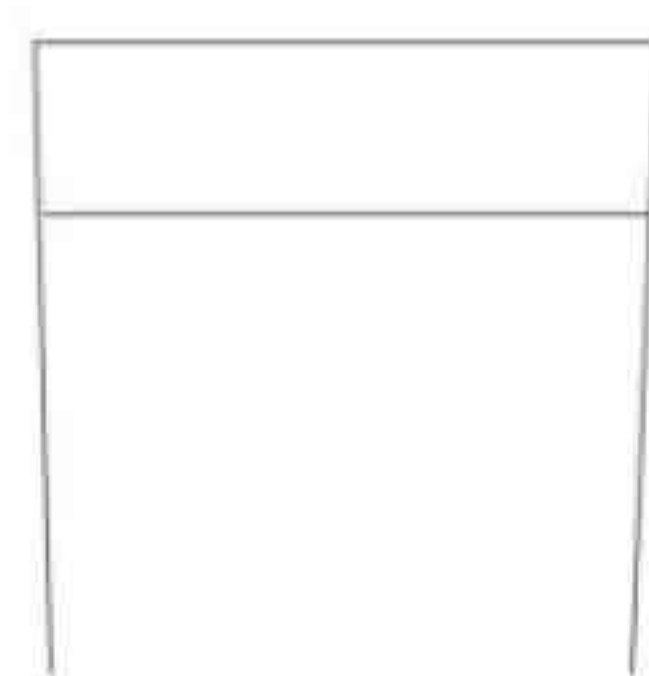
SSC-23-11-69
15 mm



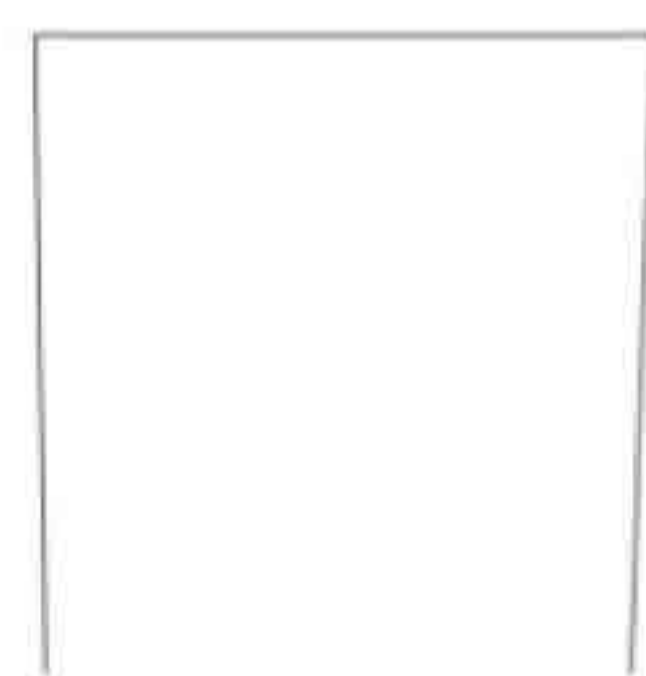
SSC-23-11-73
15 mm



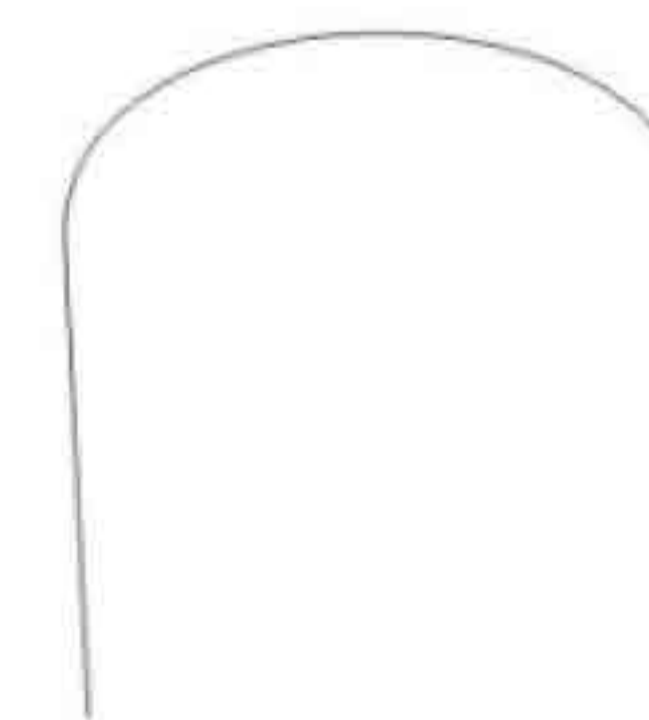
SSC-23-11-77
15 mm



SSC-23-11-70
20 mm



SSC-23-11-74
20 mm



SSC-23-11-78
20 mm



SSC-23-11-71
25 mm



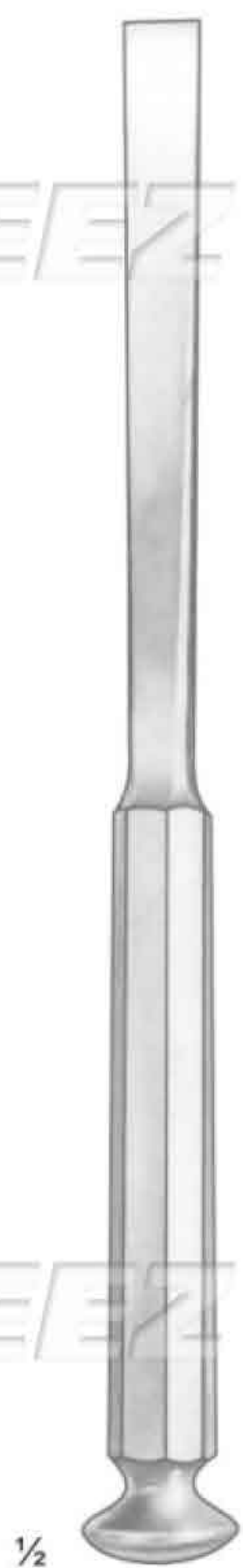
SSC-23-11-75
25 mm



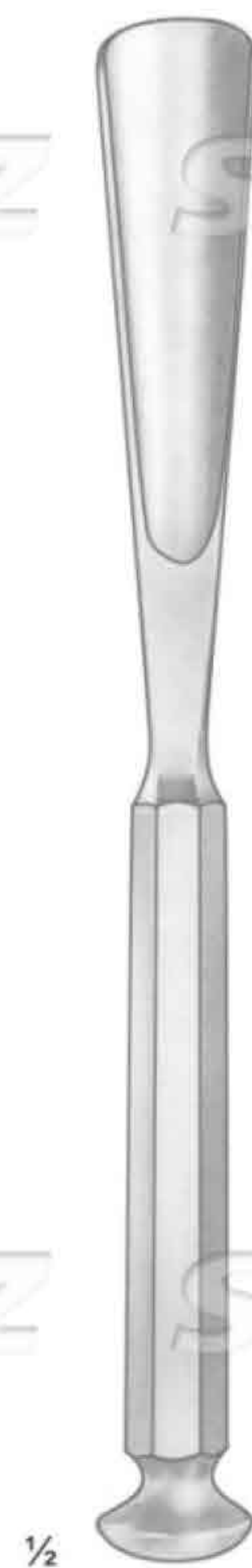
SSC-23-11-79
25 mm



Stille
20.0 cm / 8"

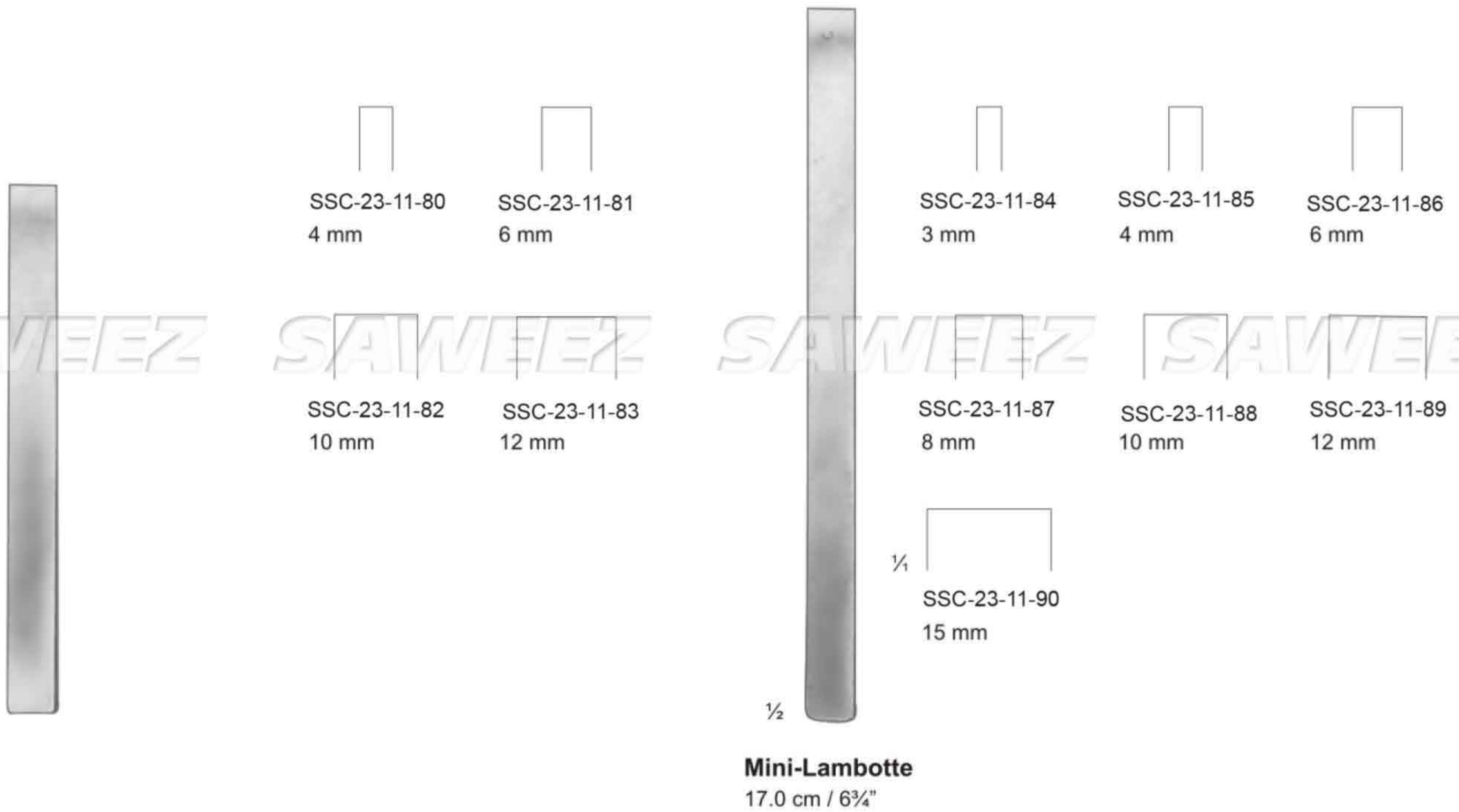


20.0 cm / 8"



20.0 cm / 8"

SAWEEZ SAWEEZ SAWEEZ SAWEEZ





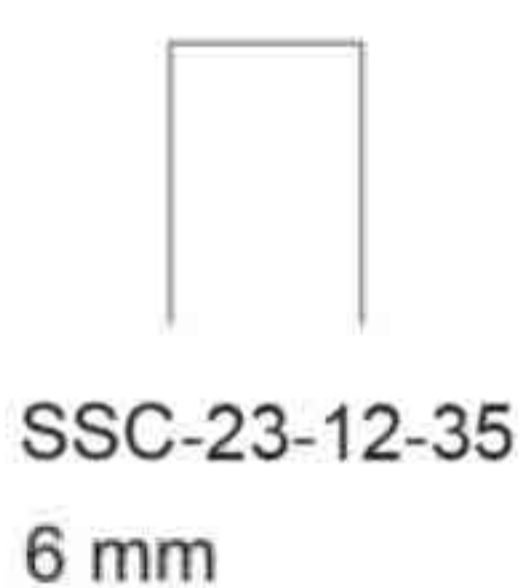
Smith-Petersen
20.0 cm / 8"



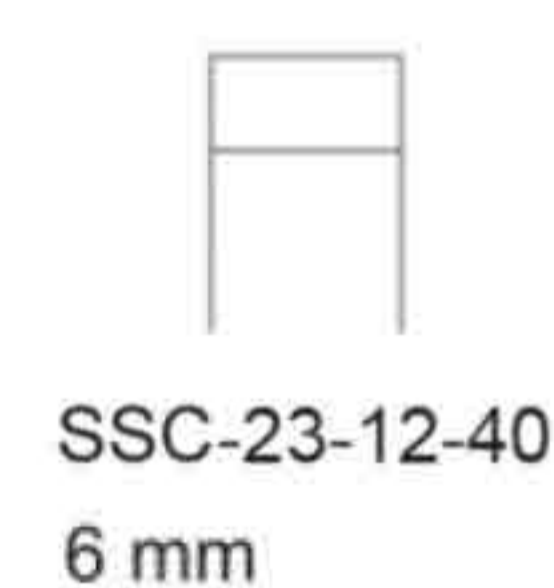
SAWEEZ SAWEEZ SAWEEZ SAWEEZ



SSC-23-12-30
3 mm



SSC-23-12-35
6 mm



SSC-23-12-40
6 mm



SSC-23-12-31
5 mm



SSC-23-12-36
13 mm



SSC-23-12-41
13 mm

SAWEEZ

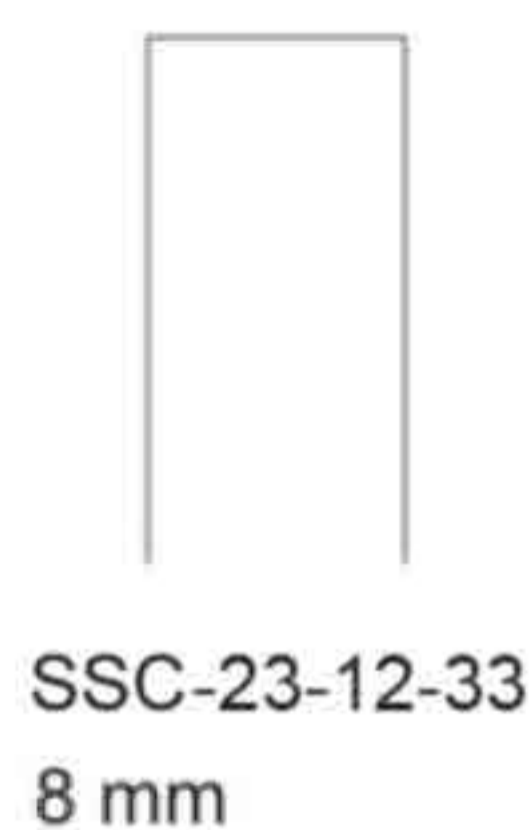
SAWEEZ

SAWEEZ

SAWEEZ



SSC-23-12-32
6 mm



SSC-23-12-33
8 mm



SSC-23-12-34
9 mm

Hoke
17.0 cm / 6¾"



SSC-23-12-37
19 mm



SSC-23-12-38
25 mm



SSC-23-12-39
32 mm

Hibbs
24.0 cm / 9½"



SSC-23-12-42
19 mm



SSC-23-12-43
25 mm



SSC-23-12-44
32 mm

Hibbs
24.0 cm / 9½"

SAWEEZ

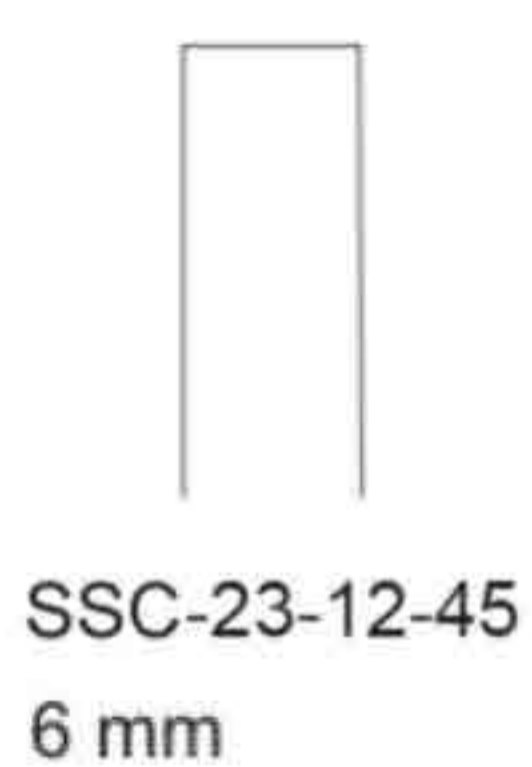
SAWEEZ

SAWEEZ

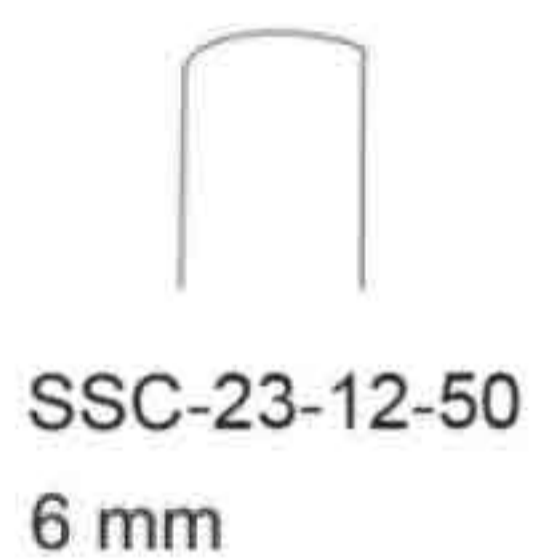
SAWEEZ



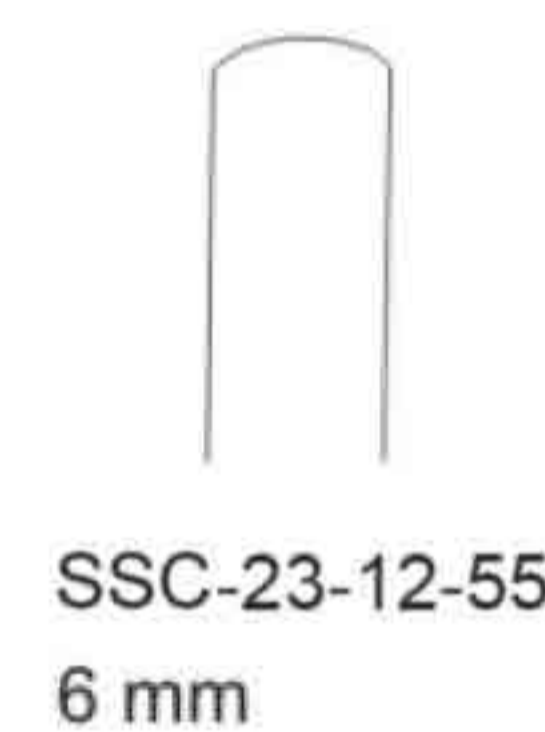
SAWEEZ SAWEEZ SAWEEZ SAWEEZ



SSC-23-12-45
6 mm



SSC-23-12-50
6 mm



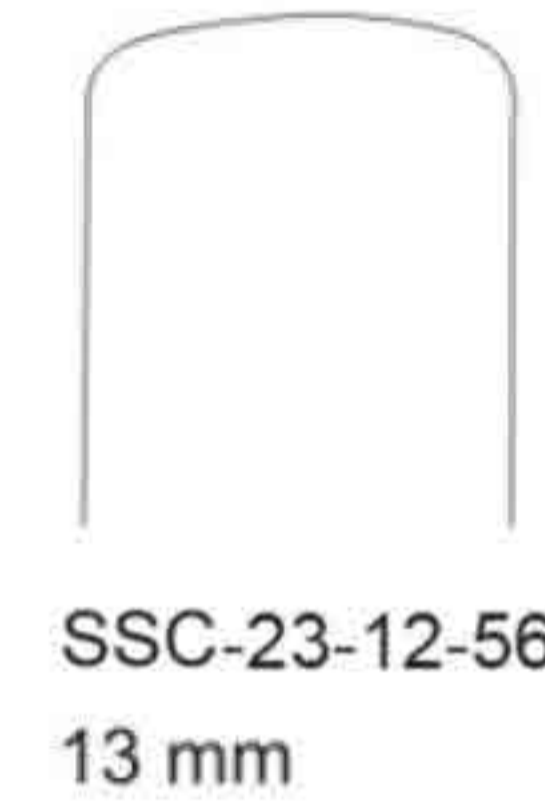
SSC-23-12-55
6 mm



SSC-23-12-46
13 mm



SSC-23-12-51
13 mm



SSC-23-12-56
13 mm



SSC-23-12-47
19 mm



SSC-23-12-52
19 mm



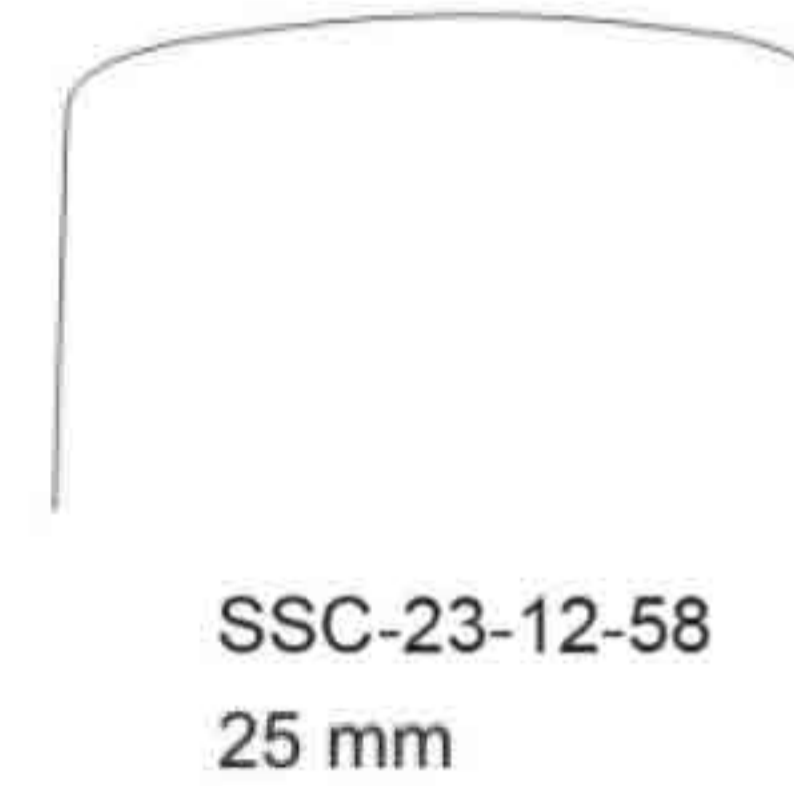
SSC-23-12-57
19 mm



SSC-23-12-48
25 mm



SSC-23-12-53
25 mm



SSC-23-12-58
25 mm



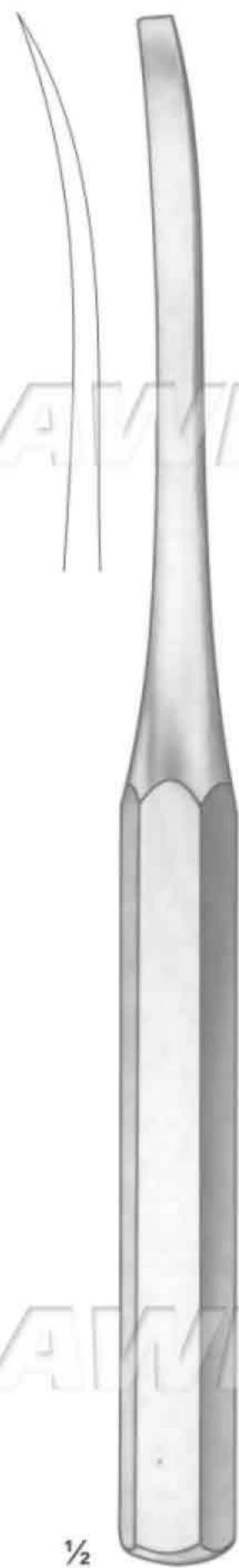
SSC-23-12-49
32 mm



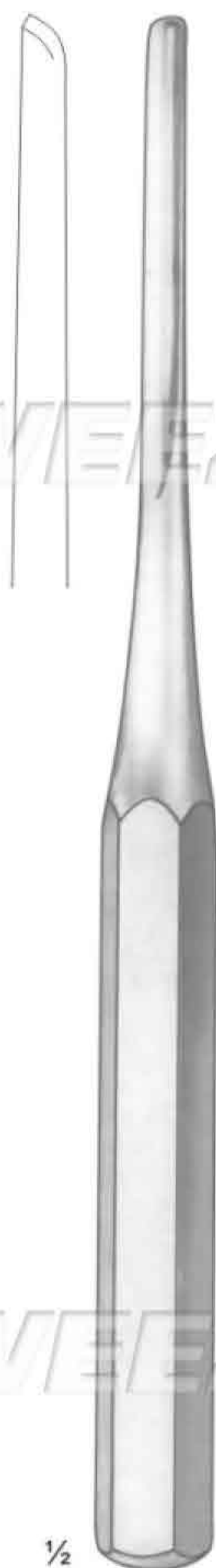
SSC-23-12-54
32 mm



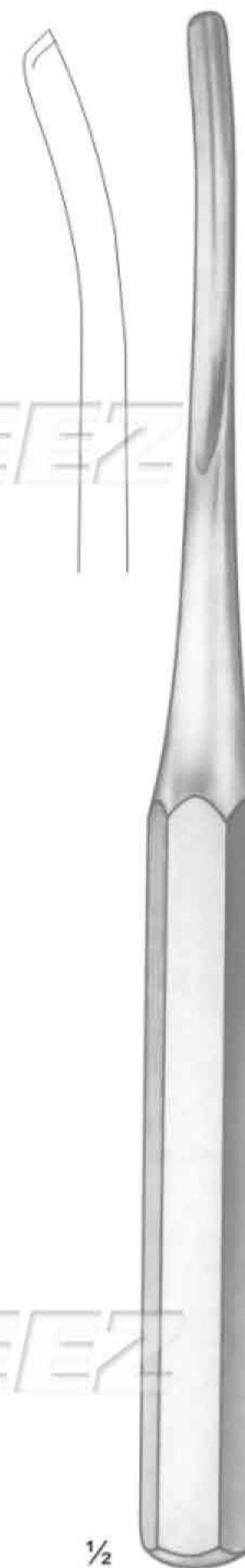
SSC-23-12-59
32 mm



Hibbs
24.0 cm / 9½"



Hibbs
24.0 cm / 9½"



Hibbs
24.0 cm / 9½"

SAWEEZ SAWEEZ SAWEEZ SAWEEZ

SAWEEZ SAWEEZ SAWEEZ SAWEEZ



SAWEEZ SAWEEZ SAWEEZ SAWEEZ



1/2

Putti
SSC-23-12-60
30.0 cm / 12"



1/2



1/4

Putti
SSC-23-12-61
27.0 cm / 10 1/2"



SAWEEZ SAWEEZ SAWEEZ



1/2

15.5 cm / 6"

SSC-23-12-62
2 mm ø

SSC-23-12-63
3 mm ø

SSC-23-12-64
4 mm ø

SSC-23-12-65
5 mm ø

SSC-23-12-66
6 mm ø

SSC-23-12-67
8 mm ø

SSC-23-12-68
10 mm ø

SAWEEZ

SAWEEZ

SAWEEZ

SAWEEZ

SAWEEZ

SAWEEZ

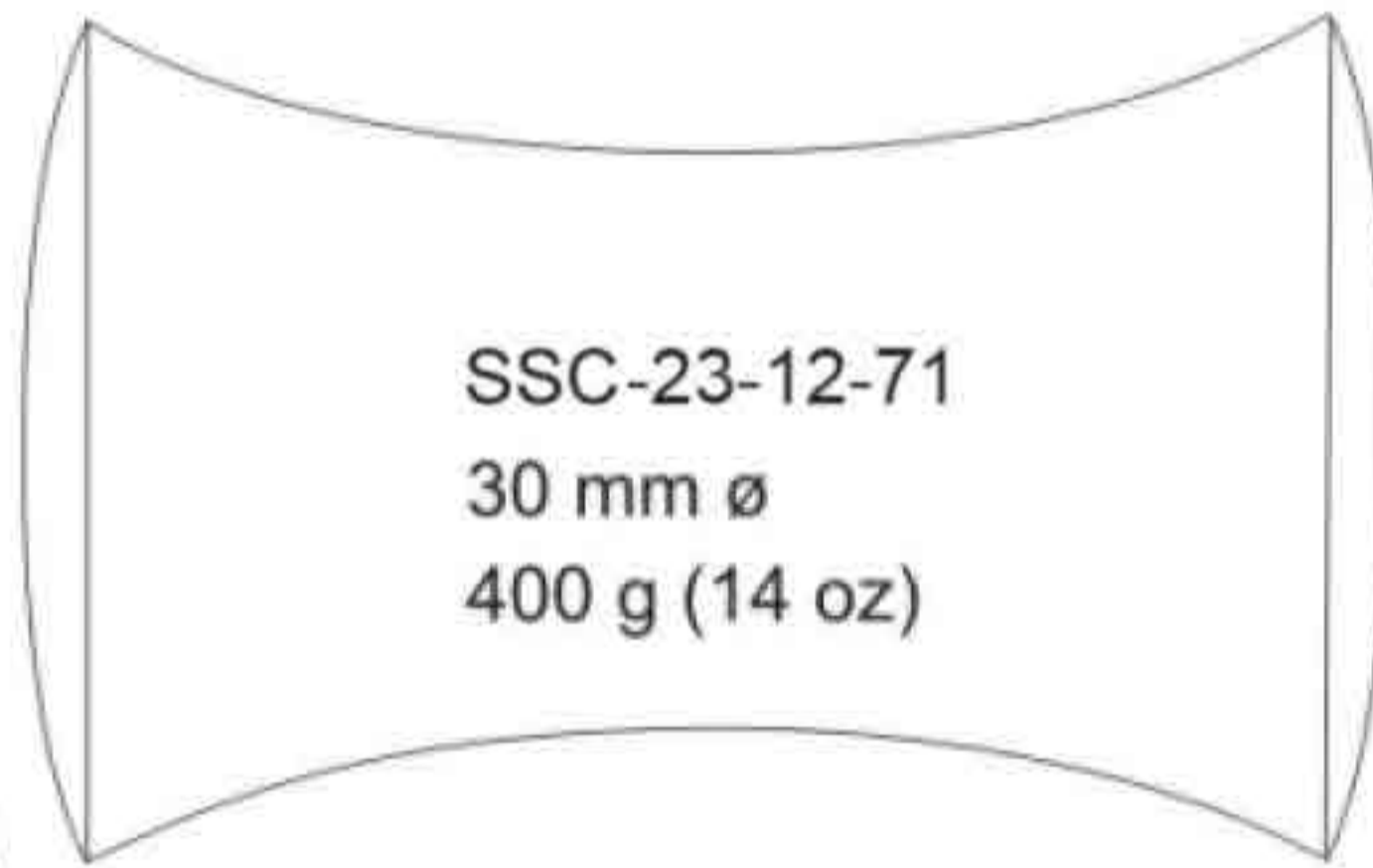
SAWEEZ



SSC-23-12-69
26 mm ø
300 g (10½ oz)



SSC-23-12-70
28 mm ø
340 g (12 oz)

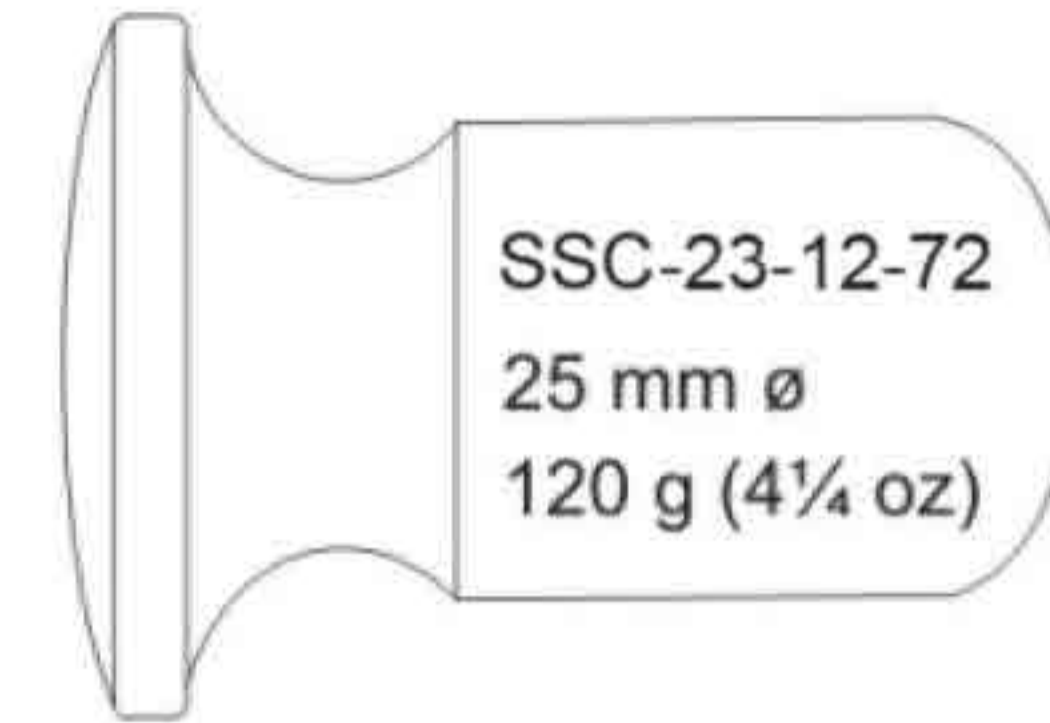


SSC-23-12-71
30 mm ø
400 g (14 oz)

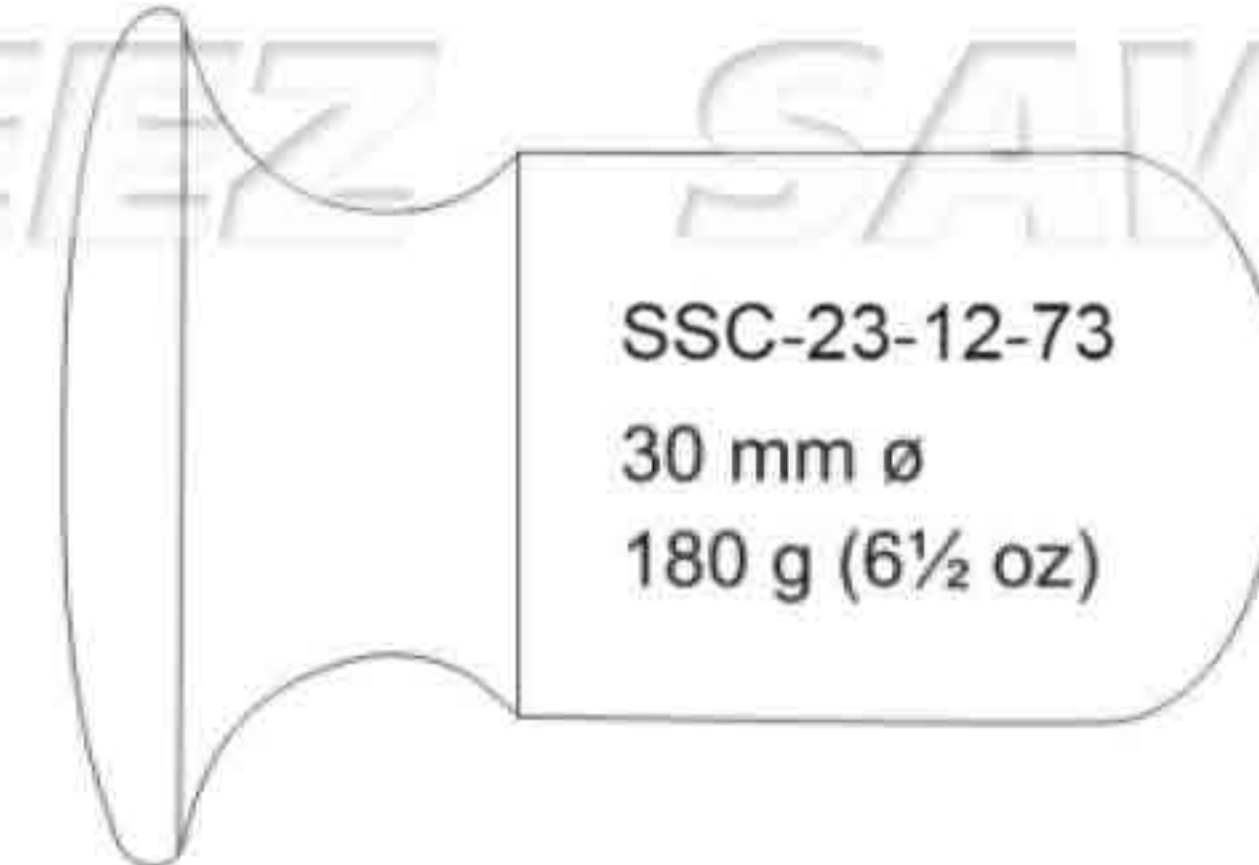
¼

Williger
24.0 cm / 9½"

½



SSC-23-12-72
25 mm ø
120 g (4¼ oz)



SSC-23-12-73
30 mm ø
180 g (6½ oz)

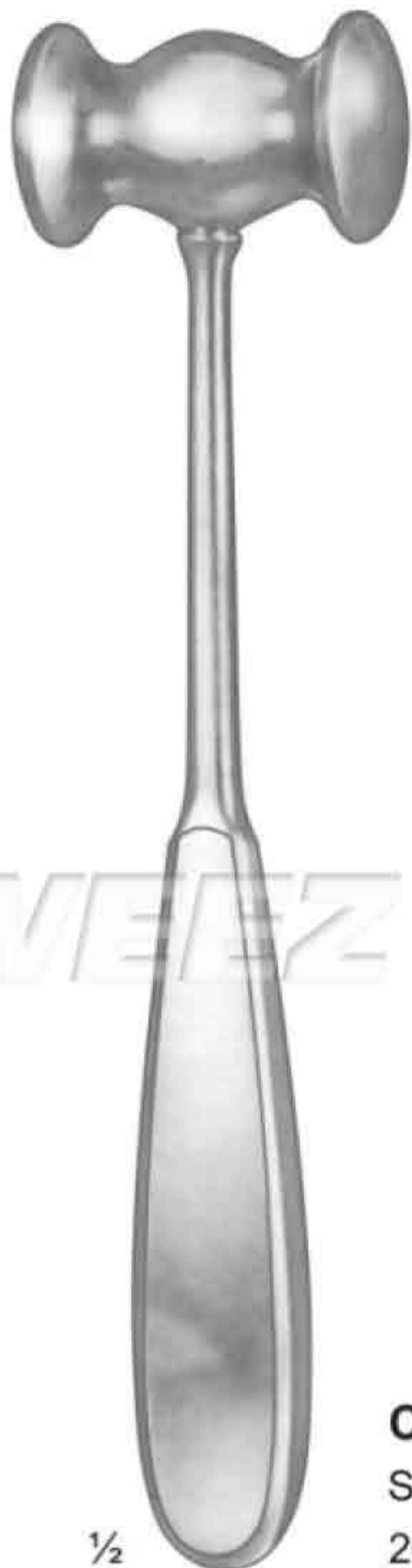


SSC-23-12-74
35 mm ø
260 g (9 oz)

¼

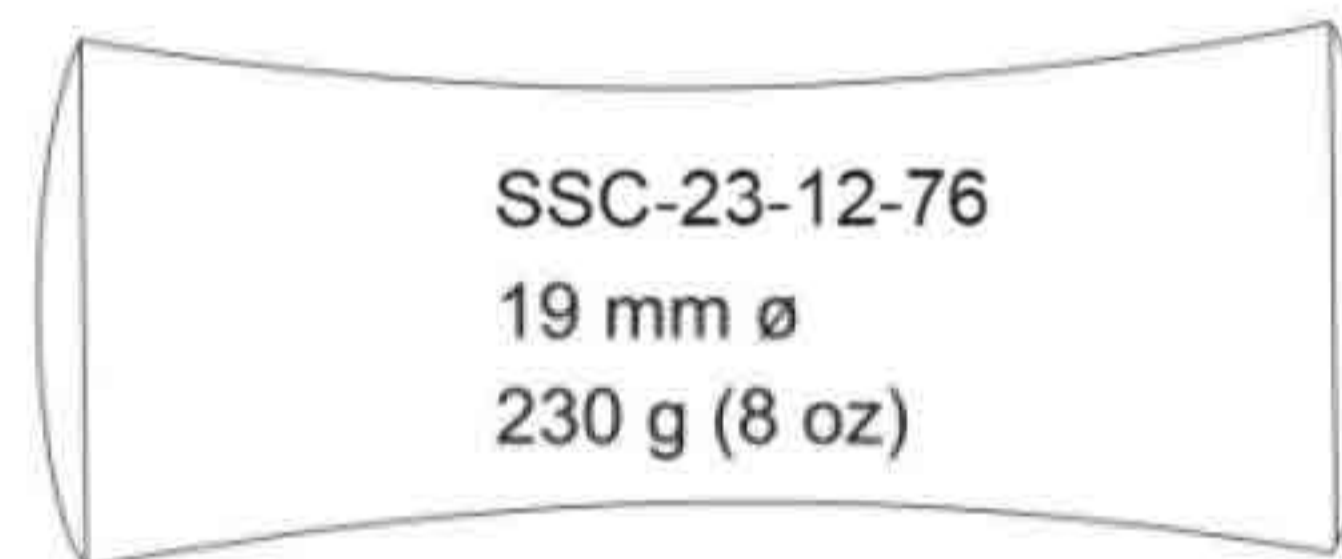
Doyen
21.0 cm / 8¼"

½



Collin
SSC-23-12-75
20.0 cm / 8"

½



SSC-23-12-76
19 mm ø
230 g (8 oz)



SSC-23-12-77
25 mm ø
260 g (9 oz)

¼

Lucae
19.0 cm / 7½"

½



20 mm ø
140 g
(5 oz)

SSC-23-12-78
16.5 cm / 6½"



SAWEEZ SAWEEZ SAWEEZ SAWEEZ

30 mm ø
510 g (18 oz)



SSC-23-12-79
26.5 cm / 10½"

with interchangeable
Ferozell faces

26 mm ø
320 g (11¼ oz)



Mead
SSC-23-12-80
17.0 cm / 6¾"
Solid
Ferozell faces only, pair

22 mm ø
200 g (7 oz)



Partsch
SSC-23-12-81
18.0 cm / 7"

45 mm ø
290 g (10 oz)



SSC-23-12-82
23.0 cm / 9"
hardwood, lead filled

SAWEEZ SAWEEZ SAWEEZ SAWEEZ



SAWEEZ

SAWEEZ

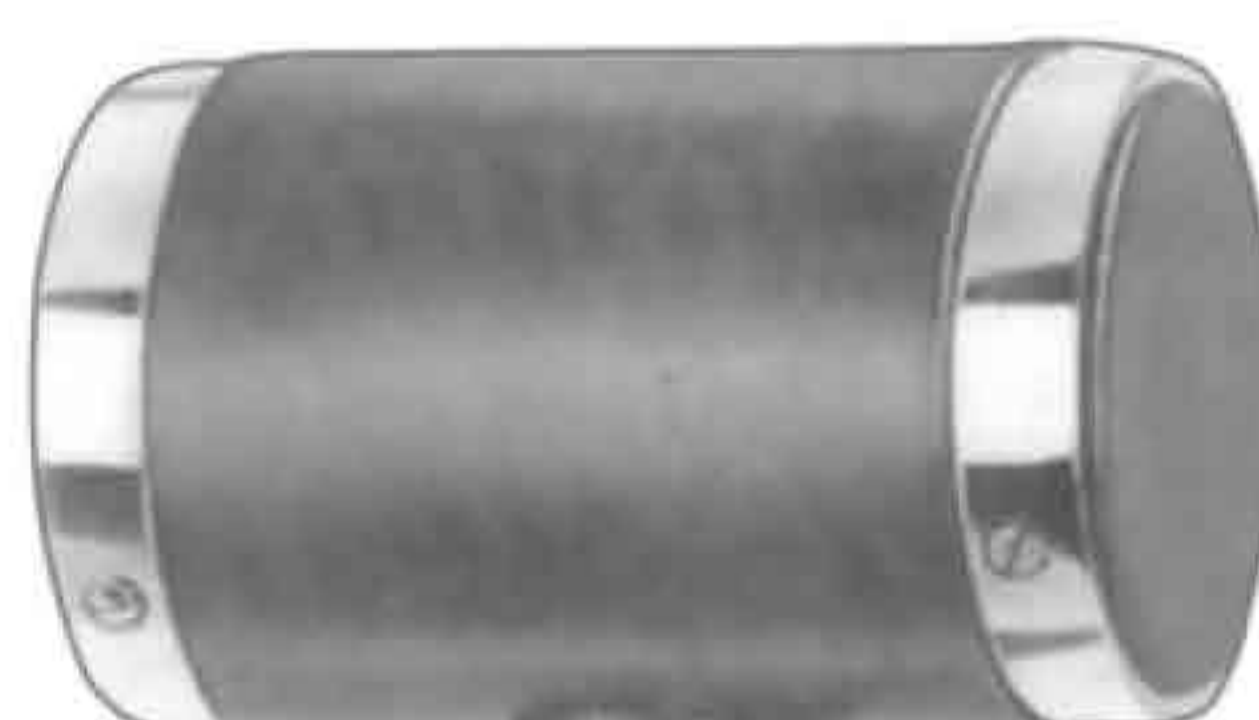
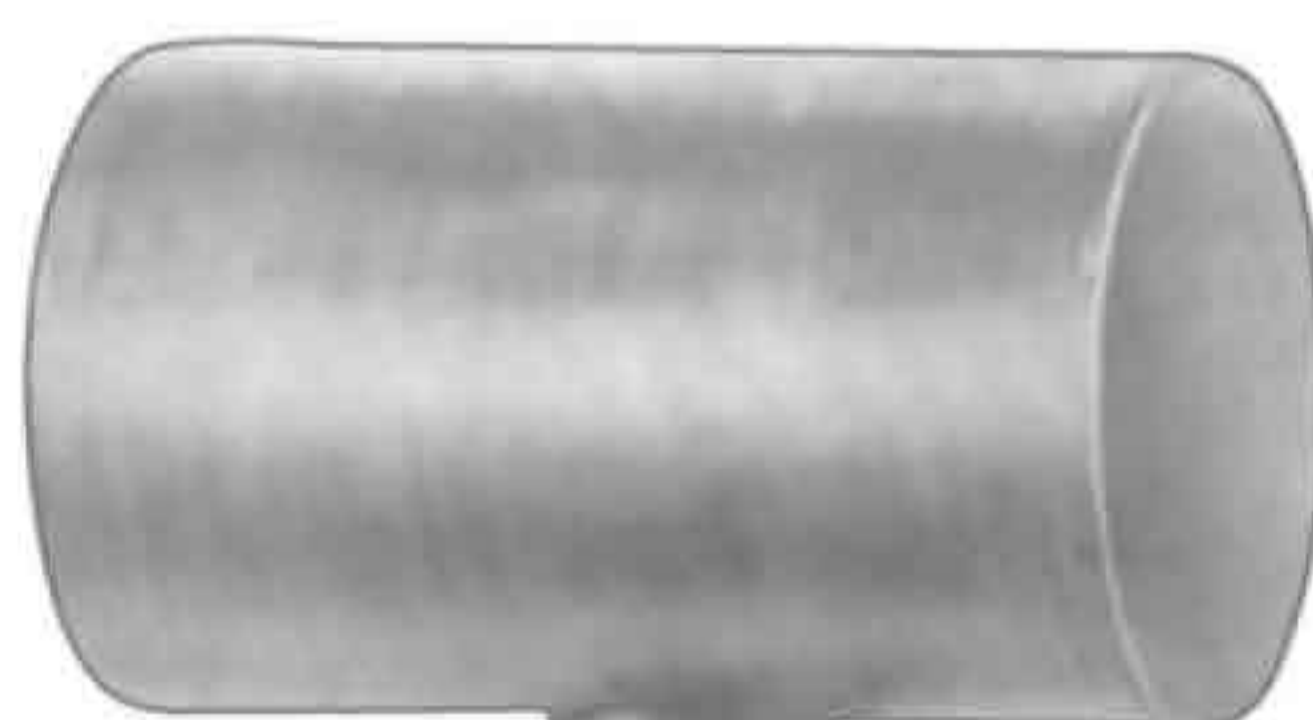
SAWEEZ

SAWEEZ

80 x 60 mm ø
400 g

42 mm ø
250 g
400 g

42 mm ø
250 g



SAWEEZ

SAWEEZ

SAWEEZ

SAWEEZ

1/2

1/2

1/2

1/2

Steinbach
SSC-23-12-83
24.0 cm / 9½"

Ferozell, solid

SSC-23-12-84
26.0 cm / 10¼"

Plastic, lead filled

SSC-23-12-85
26.0 cm / 10¼"

Ferozell, without lead

SSC-23-12-86
26.0 cm / 10¼"

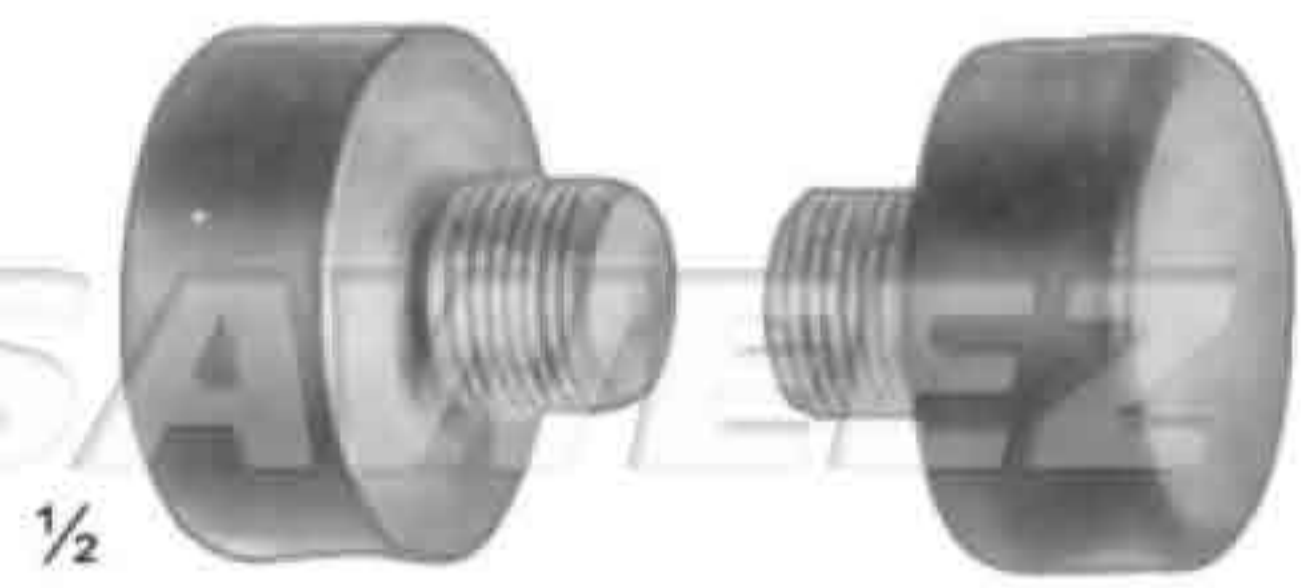
Ferozell, without lead

SSC-23-12-87
26.5 cm / 10½"

repercussion free



SAWEEZ SAWEEZ SAWEEZ SAWEEZ



1/2

SSC-23-12-88
Spare faces, pair

42 mm ø
530 g (19 oz)

30 mm ø



1/2

SSC-23-12-89
26.5 cm / 10½"

steel, soid,
with plastic handle

30 mm ø
480 g



1/2

SSC-23-12-90
24.0 cm / 9½"

steel, soid,
with plastic handle

37 mm ø
370 g

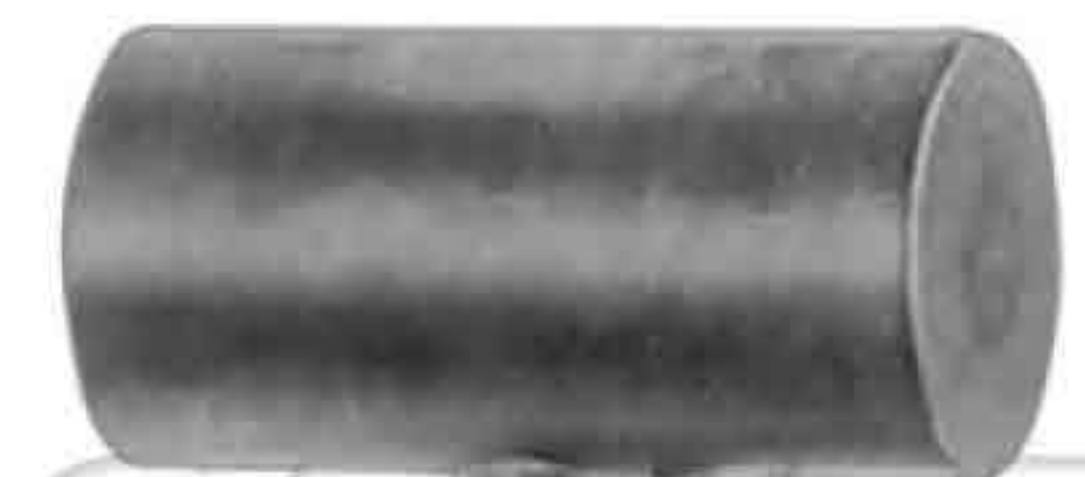


1/2

SSC-23-12-91
22.5 cm / 9"

steel, soid,
with ferrozell faces

30 mm
125 g (4 oz)



1/2

SSC-23-12-92
22.5 cm / 9"

ferrozell soid

SAWEEZ SAWEEZ SAWEEZ SAWEEZ

SAWEEZ SAWEEZ SAWEEZ SAWEEZ



SAWEEZ SAWEEZ SAWEEZ SAWEEZ

450 g (1 lb.)

900 g (2 lb.)



SAWEEZ SAWEEZ SAWEEZ SAWEEZ

SAWEEZ SAWEEZ SAWEEZ SAWEEZ

1/2

1/2

1/2

SSC-23-12-93
24.0 cm / 9 1/2"

SSC-23-12-94
26.5 cm / 10 1/2"

SSC-23-12-95
26.5 cm / 10 1/2"

steel, solid,
with plastic handle

steel, solid

steel, solid



SAWEEZ SAWEEZ SAWEEZ SAWEEZ

Fig. 0000
SSC-23-12-96

Fig. 2
SSC-23-13-01

Fig. 000
SSC-23-12-97

Fig. 3
SSC-23-13-02

Fig. 00
SSC-23-12-98

Fig. 4
SSC-23-13-03

Fig. 0
SSC-23-12-99

Fig. 5
SSC-23-13-04

1/4
Fig. 1
SSC-23-13-00

Fig. 6
SSC-23-13-05

Fig. 0
SSC-23-13-06

Fig. 1
SSC-23-13-07

Fig. 2
SSC-23-13-08

Fig. 3
SSC-23-13-09

1/4
Fig. 4
SSC-23-13-10



1/2
Volkman
17.0 cm / 6 3/4"

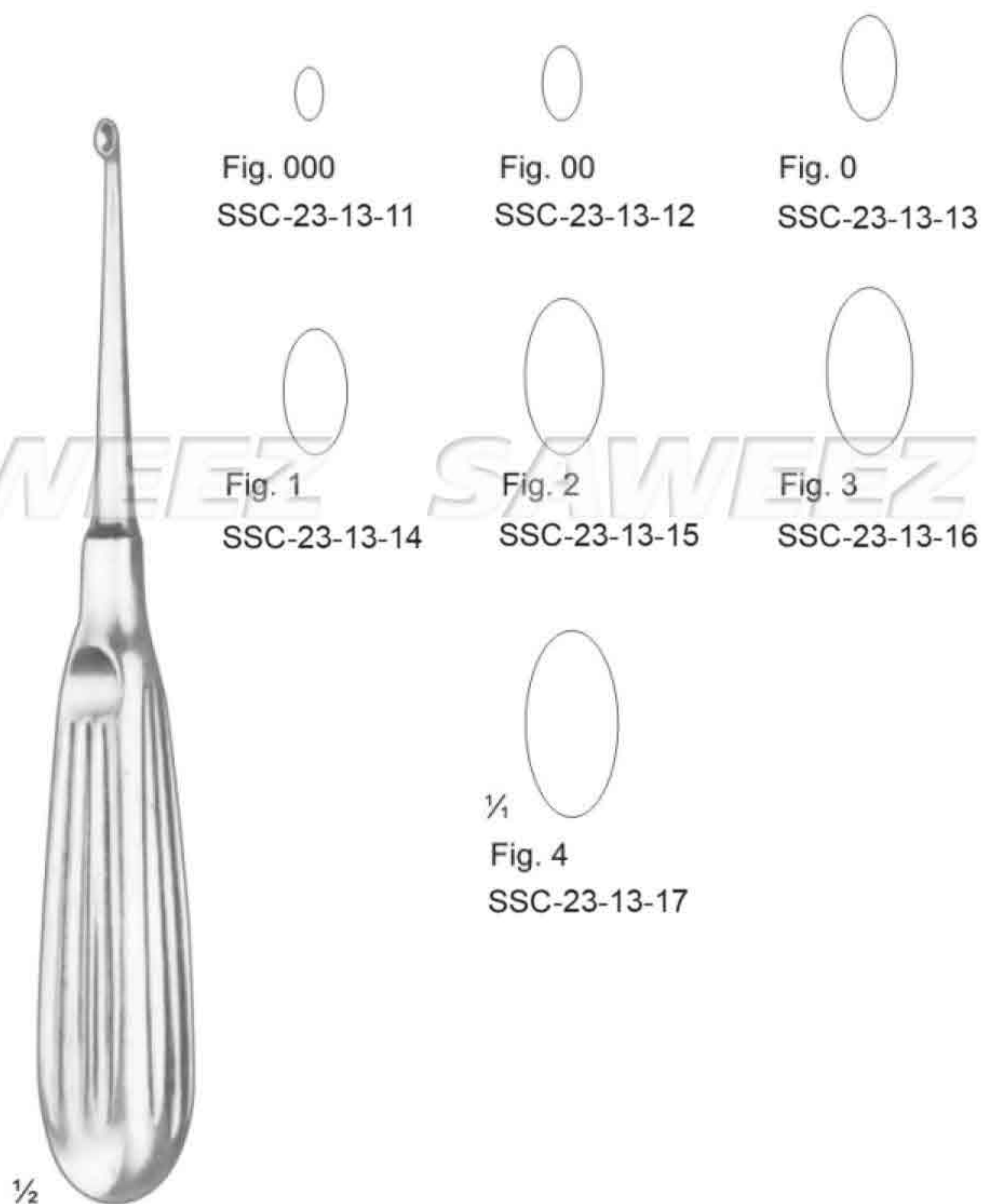
Handle from artificial wood



1/2
Volkman
27.0 cm / 10 3/4"

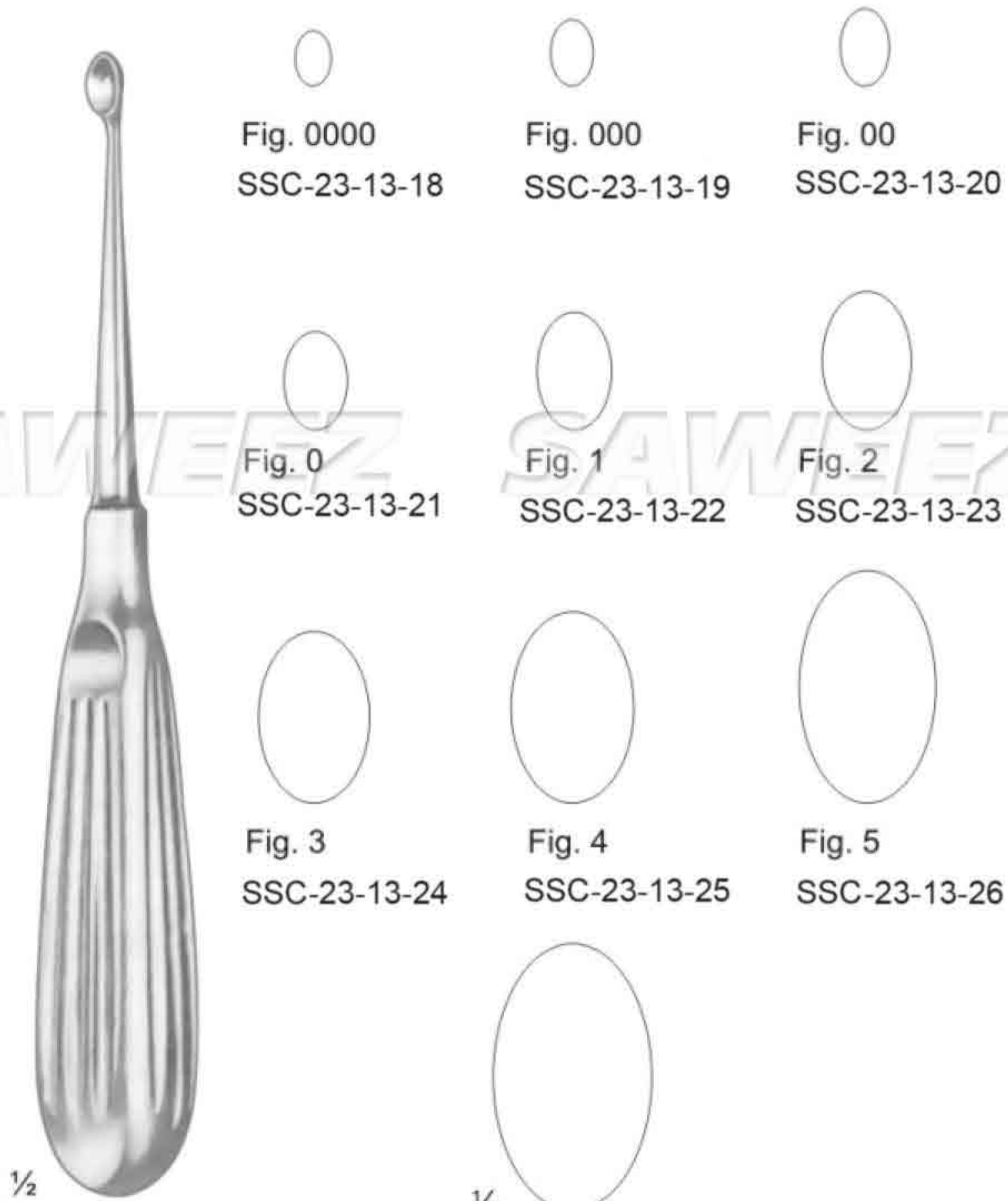
Handle from artificial wood

SAWEEZ SAWEEZ SAWEEZ SAWEEZ



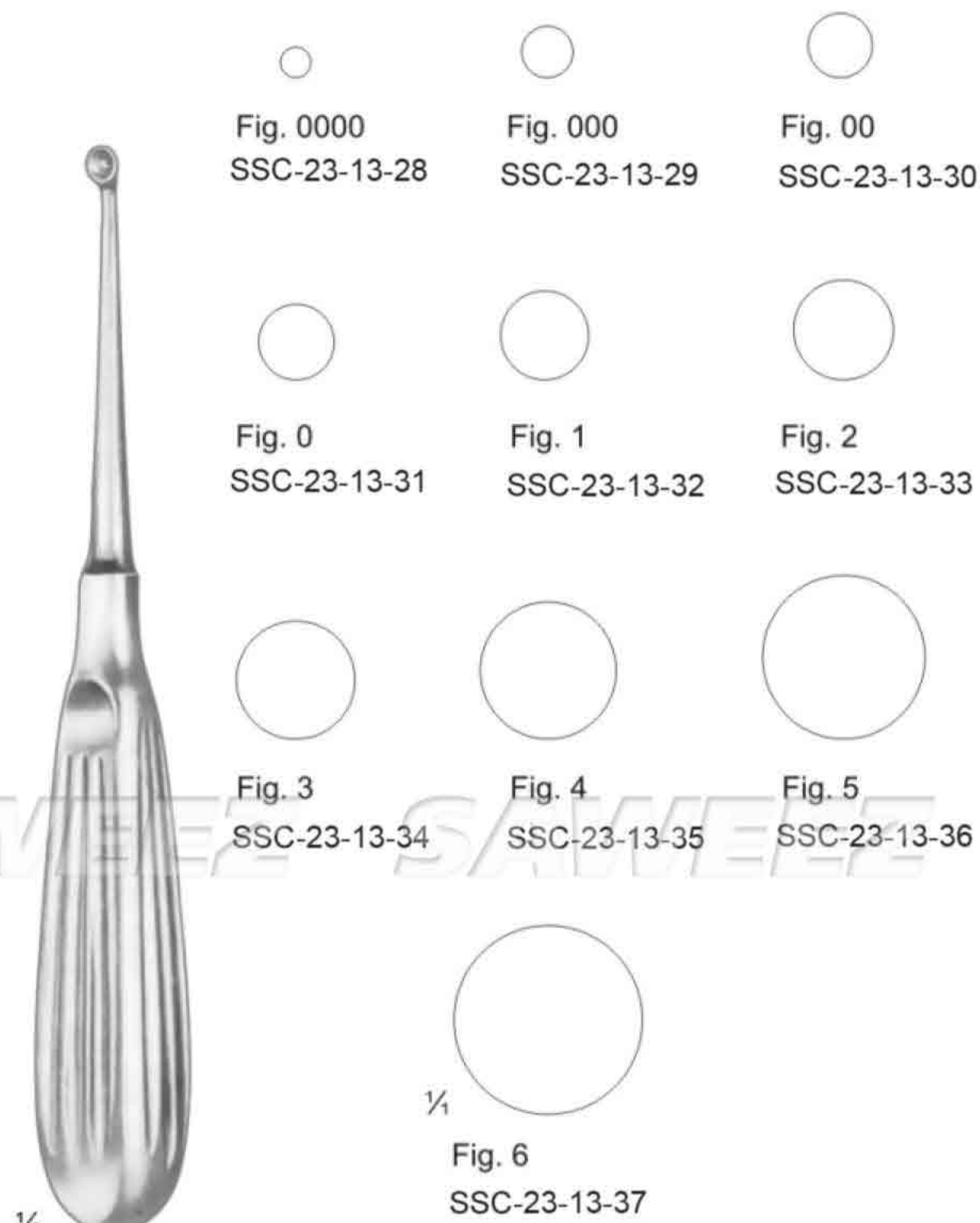
Schede

- Fig. 000 SSC-23-13-11
- Fig. 00 SSC-23-13-12
- Fig. 0 SSC-23-13-13
- Fig. 1 SSC-23-13-14
- Fig. 2 SSC-23-13-15
- Fig. 3 SSC-23-13-16
- 1/4 Fig. 4 SSC-23-13-17



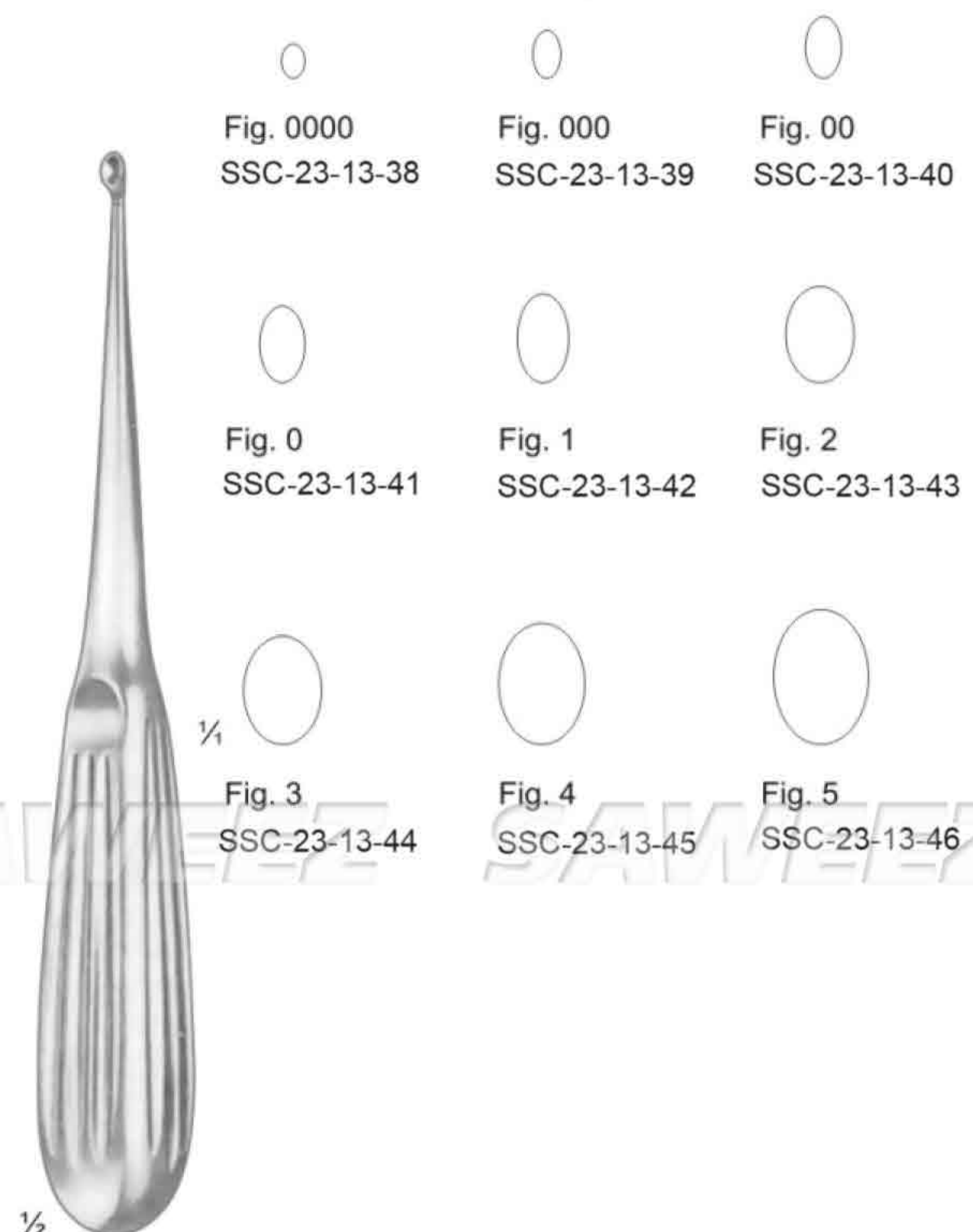
Volkmann

- Fig. 0000 SSC-23-13-18
- Fig. 000 SSC-23-13-19
- Fig. 00 SSC-23-13-20
- Fig. 0 SSC-23-13-21
- Fig. 1 SSC-23-13-22
- Fig. 2 SSC-23-13-23
- Fig. 3 SSC-23-13-24
- Fig. 4 SSC-23-13-25
- Fig. 5 SSC-23-13-26
- 1/4 Fig. 6 SSC-23-13-27



Bruns

- Fig. 0000 SSC-23-13-28
- Fig. 000 SSC-23-13-29
- Fig. 00 SSC-23-13-30
- Fig. 0 SSC-23-13-31
- Fig. 1 SSC-23-13-32
- Fig. 2 SSC-23-13-33
- Fig. 3 SSC-23-13-34
- Fig. 4 SSC-23-13-35
- Fig. 5 SSC-23-13-36
- 1/4 Fig. 6 SSC-23-13-37



Spratt

- Fig. 0000 SSC-23-13-38
- Fig. 000 SSC-23-13-39
- Fig. 00 SSC-23-13-40
- Fig. 0 SSC-23-13-41
- Fig. 1 SSC-23-13-42
- Fig. 2 SSC-23-13-43
- 1/4 Fig. 3 SSC-23-13-44
- Fig. 4 SSC-23-13-45
- Fig. 5 SSC-23-13-46



SAWEEZ SAWEEZ SAWEEZ SAWEEZ

0
SSC-23-13-55

SSC-23-13-56

0
SSC-23-13-57

0
SSC-23-13-58

0
SSC-23-13-59

0
SSC-23-13-60

0
SSC-23-13-61

0
SSC-23-13-62

1/4
SSC-23-13-63

1/4
SSC-23-13-64

1/4
SSC-23-13-65

1/4
SSC-23-13-66

Fig. 00
SSC-23-13-47

Fig. 0
SSC-23-13-48

Fig. 1
SSC-23-13-49

1/4
SSC-23-13-50

Fig. 00
SSC-23-13-51

Fig. 0
SSC-23-13-52

Fig. 1
SSC-23-13-53

Fig. 2
SSC-23-13-54

1/2

1/2

1/2

Williger
17.5 cm / 7"

Bruns
23.0 cm / 9"

25.0 cm / 10"

SAWEEZ SAWEEZ SAWEEZ SAWEEZ



SAWEEZ SAWEEZ SAWEEZ SAWEEZ

SSC-23-13-67

SSC-23-13-68

SSC-23-13-69

SSC-23-13-70

SSC-23-13-71

1/4 SSC-23-13-72

1/2

Simon
24.0 cm / 9 1/2"

SSC-23-13-73

SSC-23-13-74

SSC-23-13-75

SSC-23-13-76

SSC-23-13-77

SSC-23-13-78

Fig. 1

Fig. 2

Fig. 3

Fig. 4

Fig. 5

Fig. 6

SSC-23-13-79

SSC-23-13-80

SSC-23-13-81

SSC-23-13-82

SSC-23-13-83

SSC-23-13-84

Fig. 1

Fig. 2

Fig. 3

Fig. 4

Fig. 5

Fig. 6

SSC-23-13-85

SSC-23-13-86

SSC-23-13-87

SSC-23-13-88

SSC-23-13-89

SSC-23-13-90

Flexible

SSC-23-13-91

SSC-23-13-92

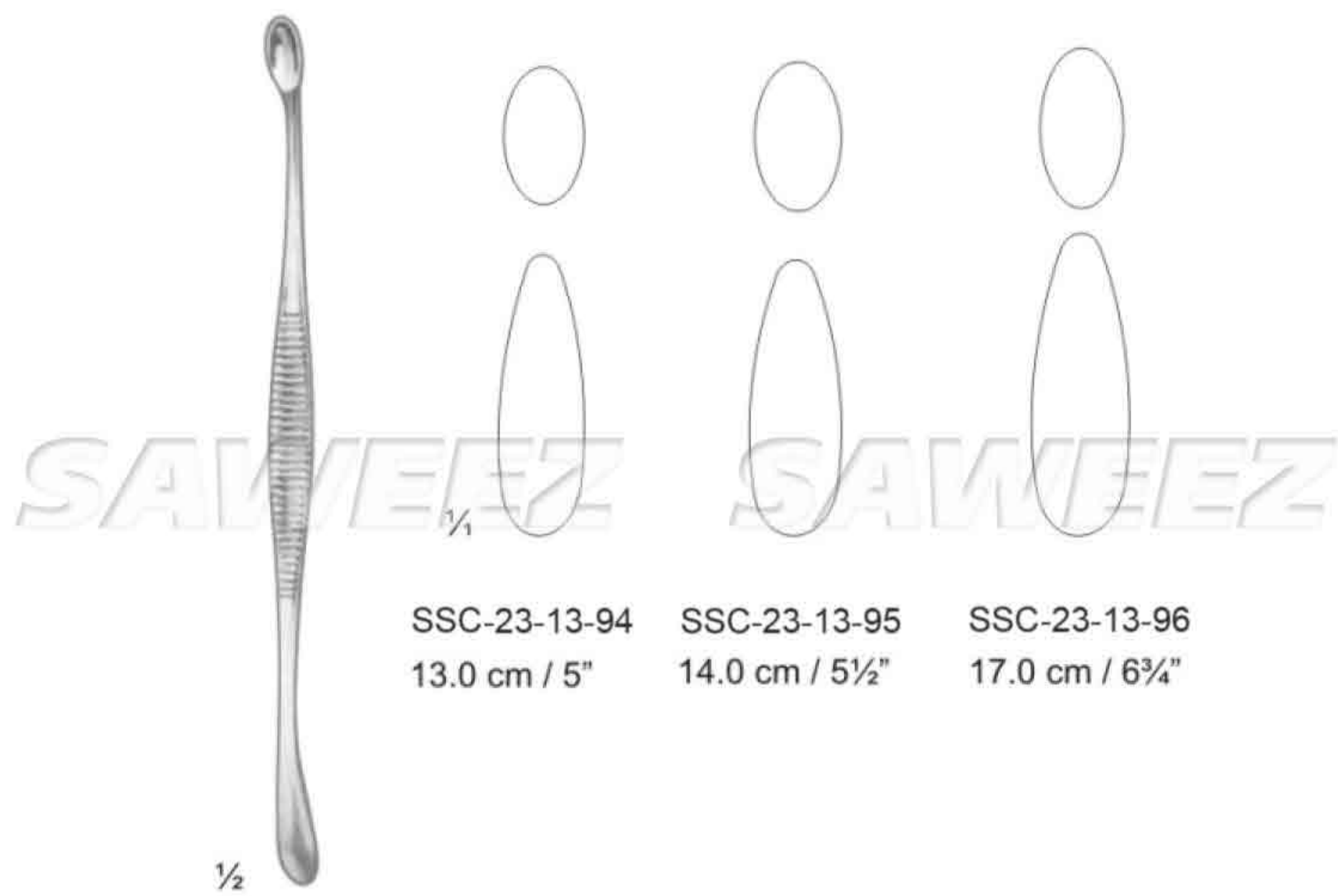
1/4 SSC-23-13-93

1/2

Mod. USA
16.0 cm / 6 1/4"

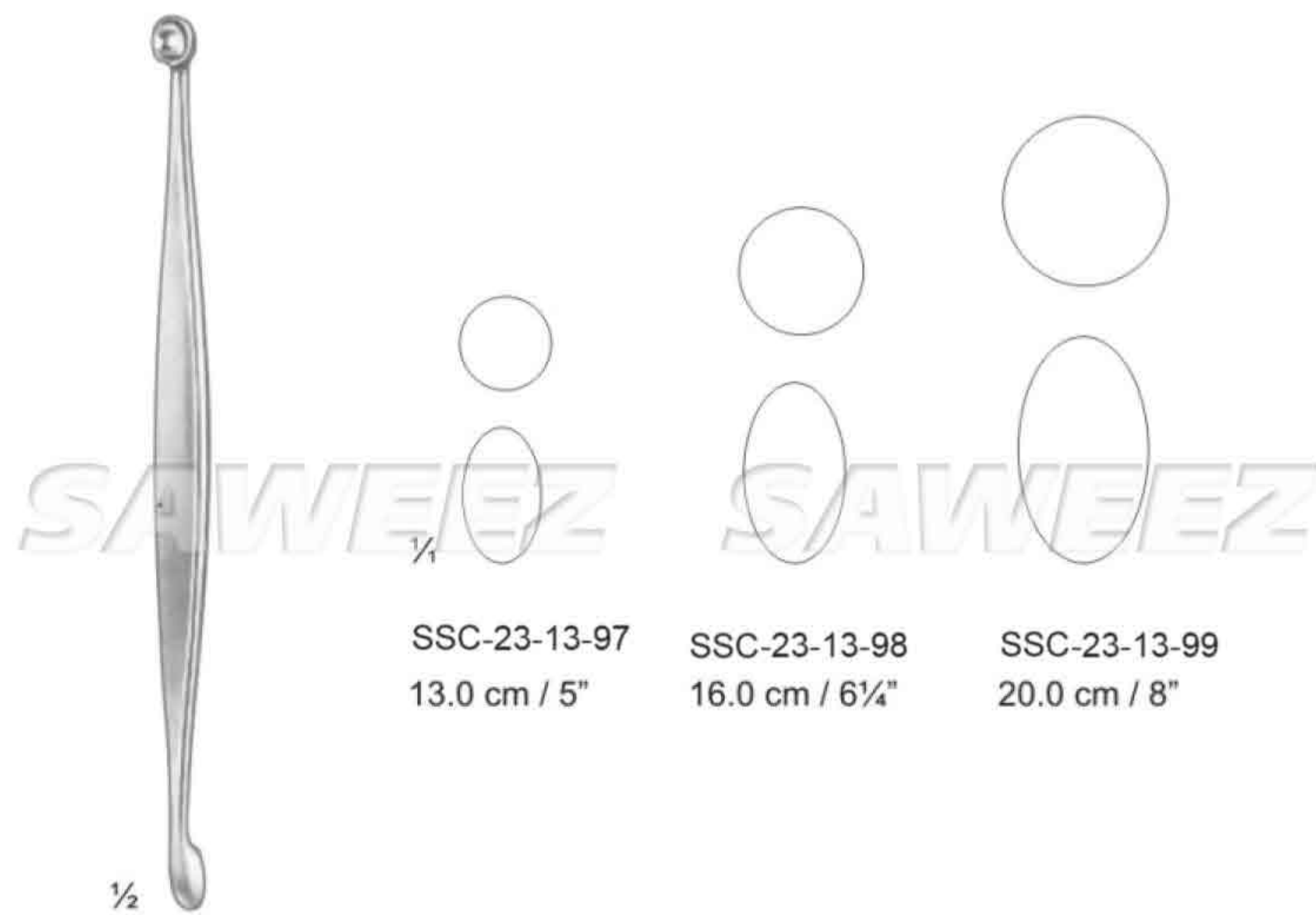
Halle
21.0 cm / 8 1/4"

SAWEEZ SAWEEZ SAWEEZ SAWEEZ



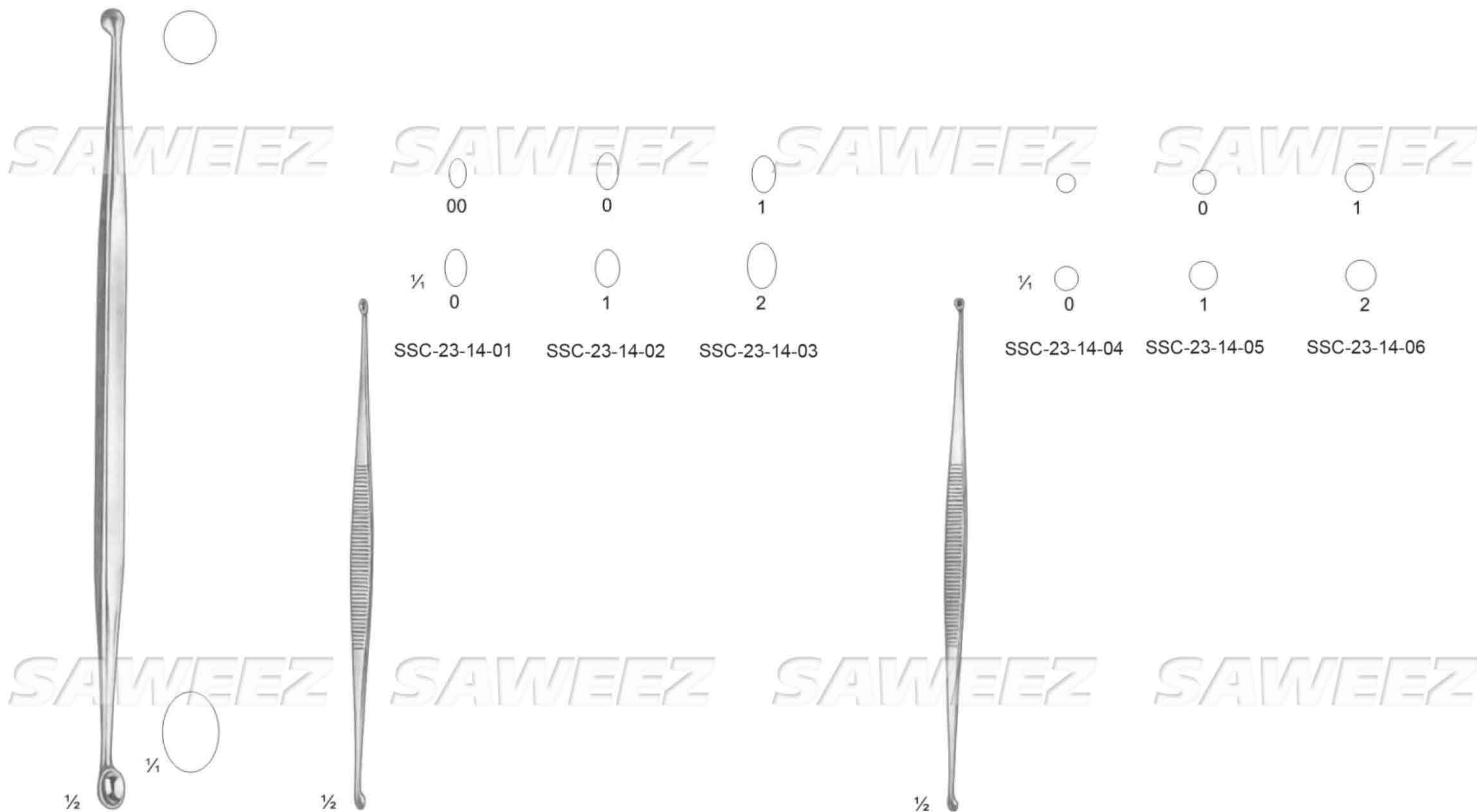
SSC-23-13-94 13.0 cm / 5"
 SSC-23-13-95 14.0 cm / 5½"
 SSC-23-13-96 17.0 cm / 6¾"

½
Volkmann



SSC-23-13-97 13.0 cm / 5"
 SSC-23-13-98 16.0 cm / 6¼"
 SSC-23-13-99 20.0 cm / 8"

½
Volkmann



SSC-23-14-01 SSC-23-14-02 SSC-23-14-03

SSC-23-14-04 SSC-23-14-05 SSC-23-14-06

SSC-23-14-00
 21.0 cm / 8¼"

Williger
 13.5 cm / 5¼"

Martini
 13.5 cm / 5¼"

oval/round

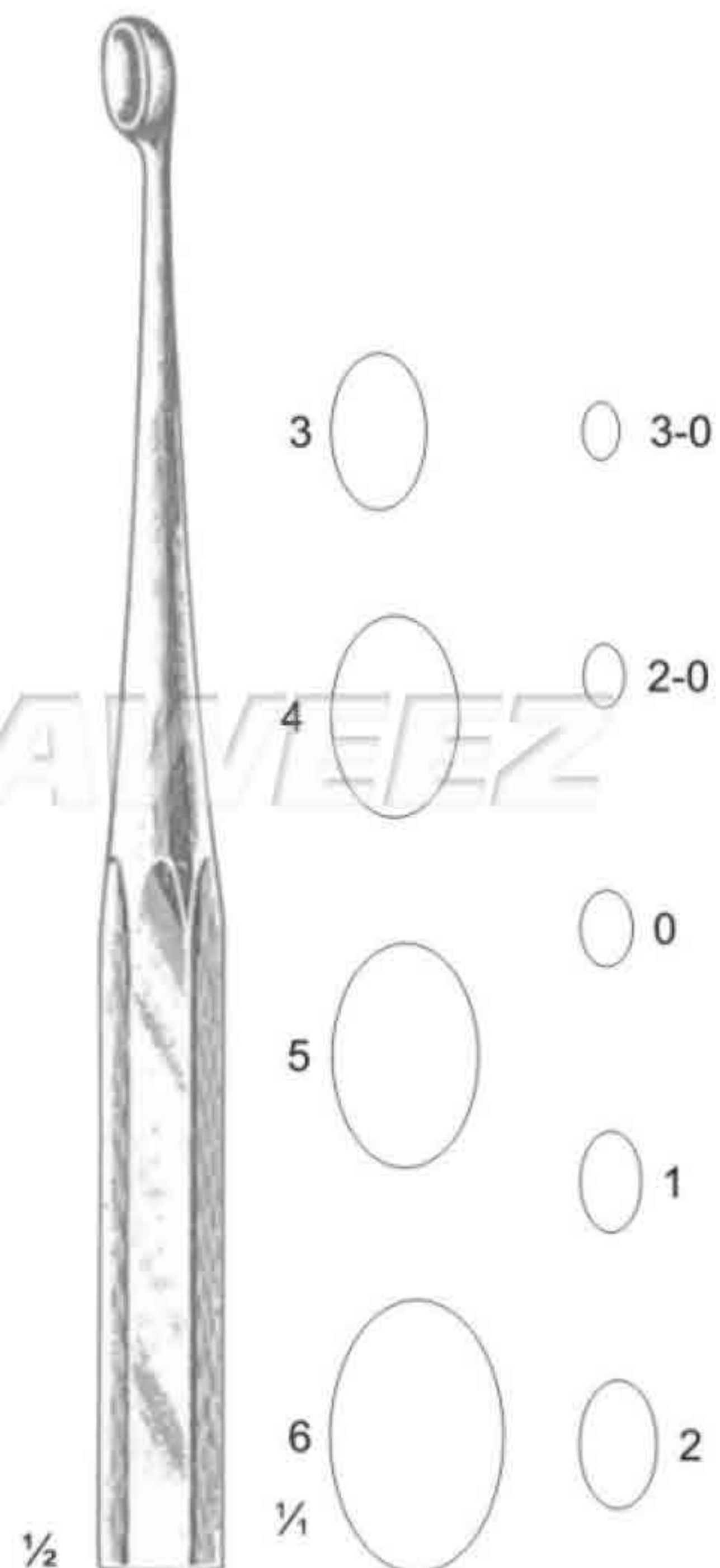


SAWEEZ SAWEEZ SAWEEZ SAWEEZ



Spinal Fusion Curettes
23.0 cm / 9", reverse angle

- SSC-23-14-07 - Size 5-0
- SSC-23-14-08 - Size 4-0
- SSC-23-14-09 - Size 3-0
- SSC-23-14-10 - Size 2-0
- SSC-23-14-11 - Size 0
- SSC-23-14-12 - Size 1
- SSC-23-14-13 - Size 2
- SSC-23-14-14 - Size 3
- SSC-23-14-15 - Size 4
- SSC-23-14-16 - Size 5
- SSC-23-14-17 - Size 6



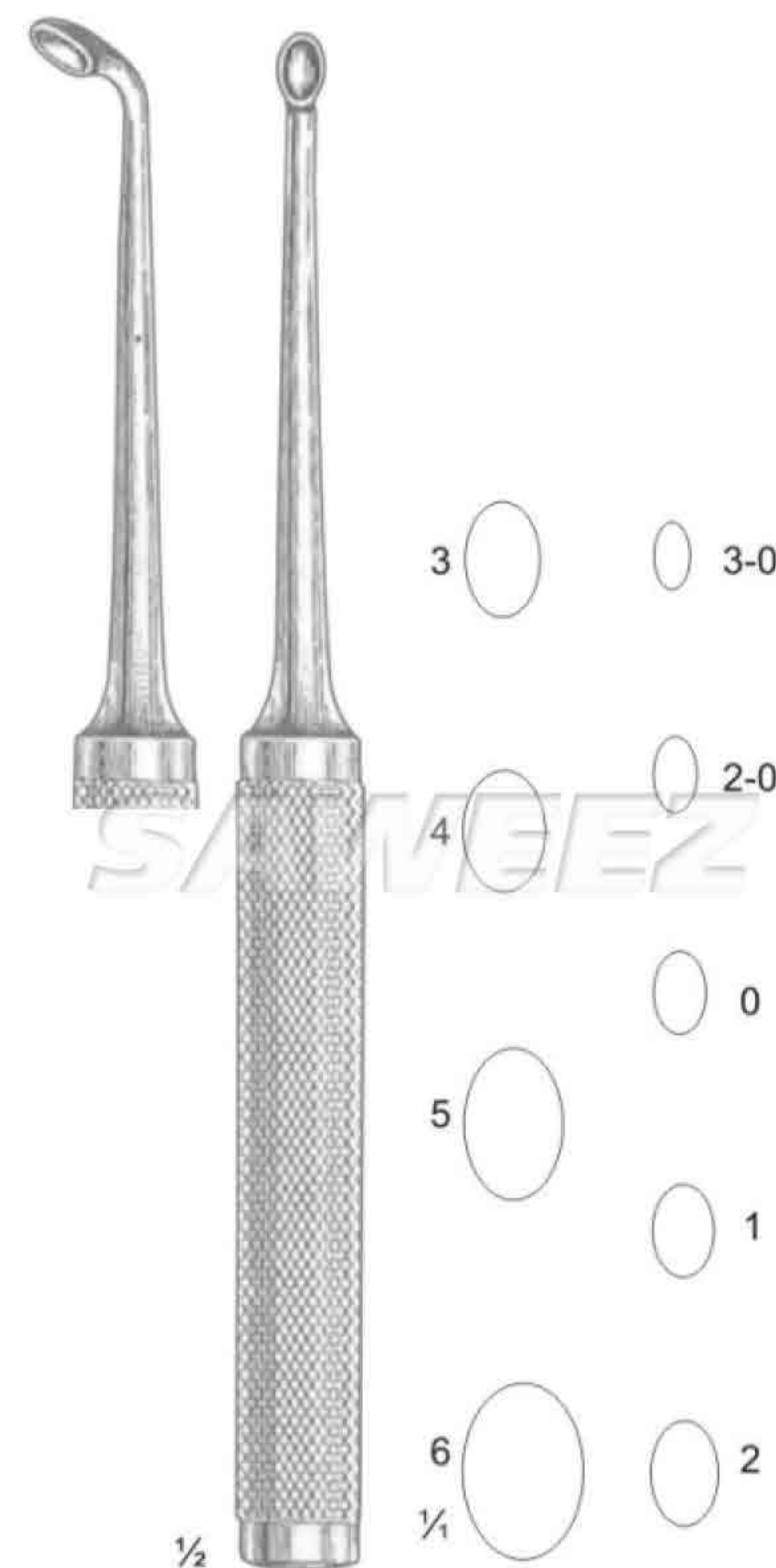
Bruns Oval Cup Curettes
23.0 cm / 9", straight,
solid hexagonal handle

- SSC-23-14-18 - Size 3-0
- SSC-23-14-19 - Size 2-0
- SSC-23-14-20 - Size 0
- SSC-23-14-21 - Size 1
- SSC-23-14-22 - Size 2
- SSC-23-14-23 - Size 3
- SSC-23-14-24 - Size 4
- SSC-23-14-25 - Size 5
- SSC-23-14-26 - Size 6



Semmes (Howard) Spinal Curettes
23.0 cm / 9" 4x7 mm cup

- SSC-23-14-27 - Straight
- SSC-23-14-28 - Slight Angle
- SSC-23-14-29 - Acute Angle

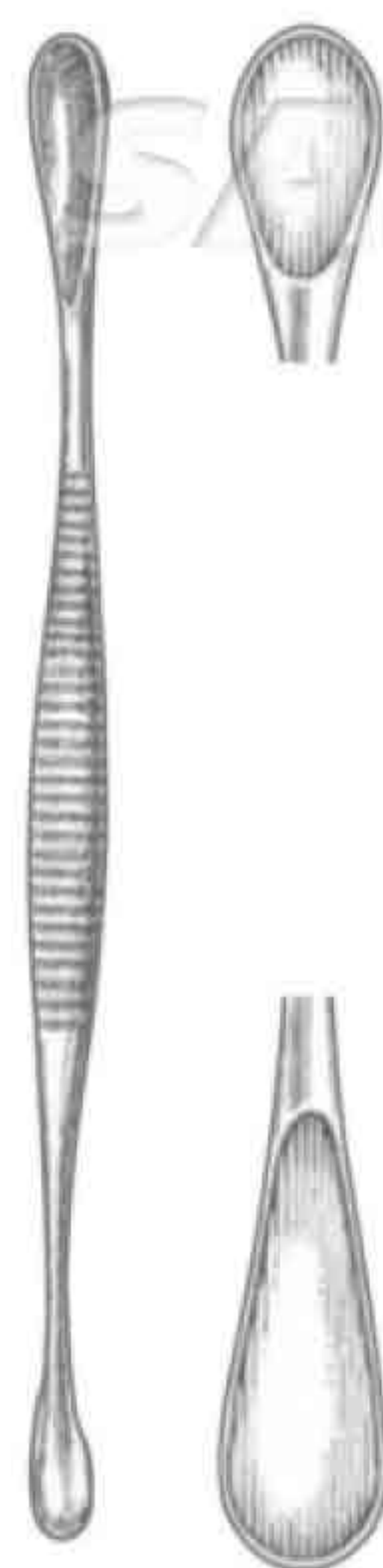
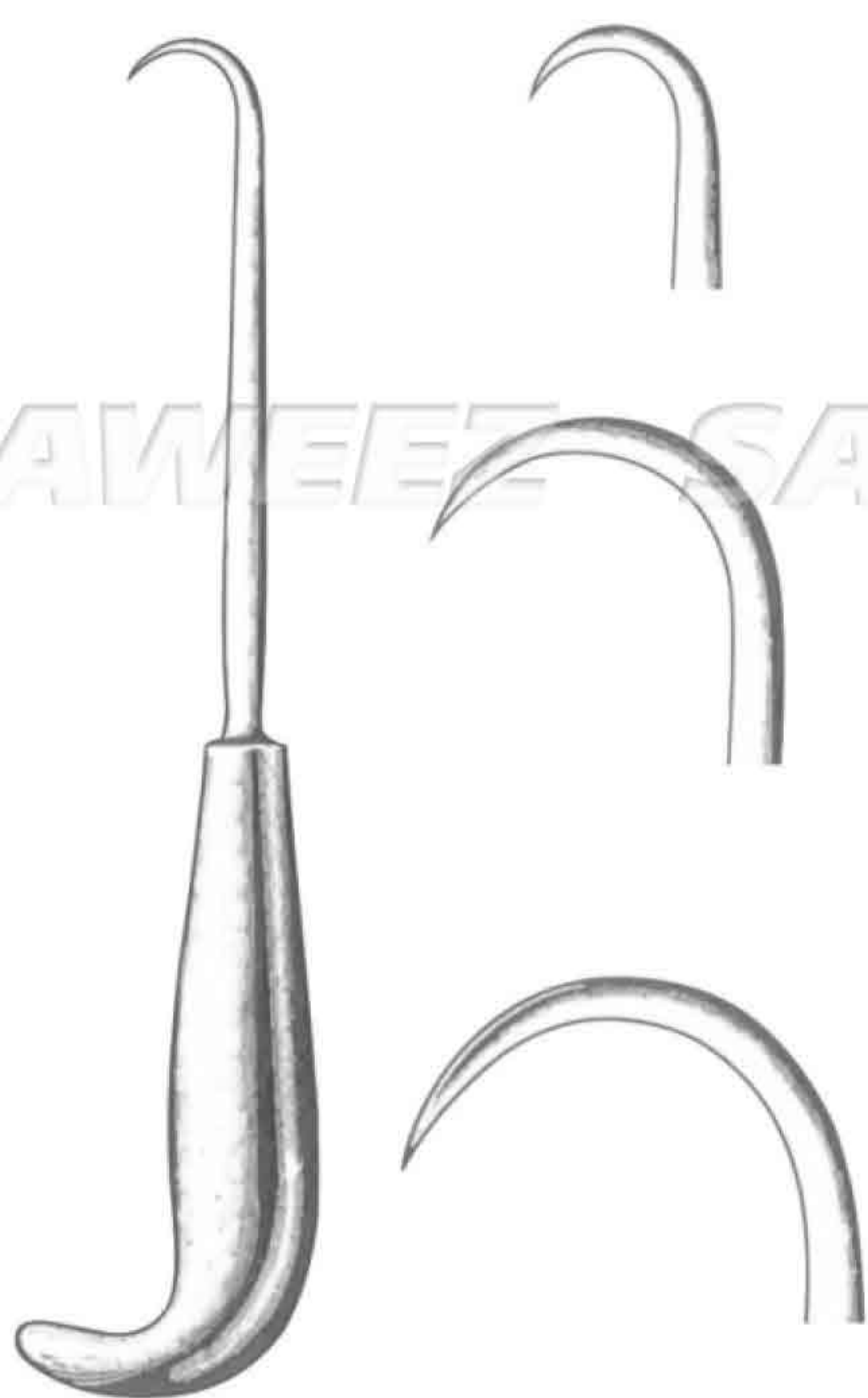


Cobb-Type Oval Cup Curettes
27.9 cm / 11", hollow knurled handle

- | Straight | Angled Tip | |
|--------------|--------------|----------|
| SSC-23-14-30 | SSC-23-14-39 | Size 3-0 |
| SSC-23-14-31 | SSC-23-14-40 | Size 2-0 |
| SSC-23-14-32 | SSC-23-14-41 | Size 0 |
| SSC-23-14-33 | SSC-23-14-42 | Size 1 |
| SSC-23-14-34 | SSC-23-14-43 | Size 2 |
| SSC-23-14-35 | SSC-23-14-44 | Size 3 |
| SSC-23-14-36 | SSC-23-14-45 | Size 4 |
| SSC-23-14-37 | SSC-23-14-46 | Size 5 |
| SSC-23-14-38 | SSC-23-14-47 | Size 6 |



SAWEEZ SAWEEZ SAWEEZ SAWEEZ



SAWEEZ SAWEEZ SAWEEZ SAWEEZ

Volkman Bone Curettes

double ended

- SSC-23-14-48 - 13.0 cm / 5", one round and one oval cup,
10.0 mm and 6.3 mm x 6.8 mm
- SSC-23-14-49 - 16.5 cm / 6½", two oval cups,
7.5 mm x 14 mm and 9 mm x 22 mm
- SSC-23-14-50 - 16.5 cm / 6½", one round and one oval cup,
14 mm and 7 mm x 9 mm
- SSC-23-14-51 - 20.0 cm / 8", one round and one oval cup,
17.5 mm and 9 mm x 11 mm

Scoville Disc Curettes

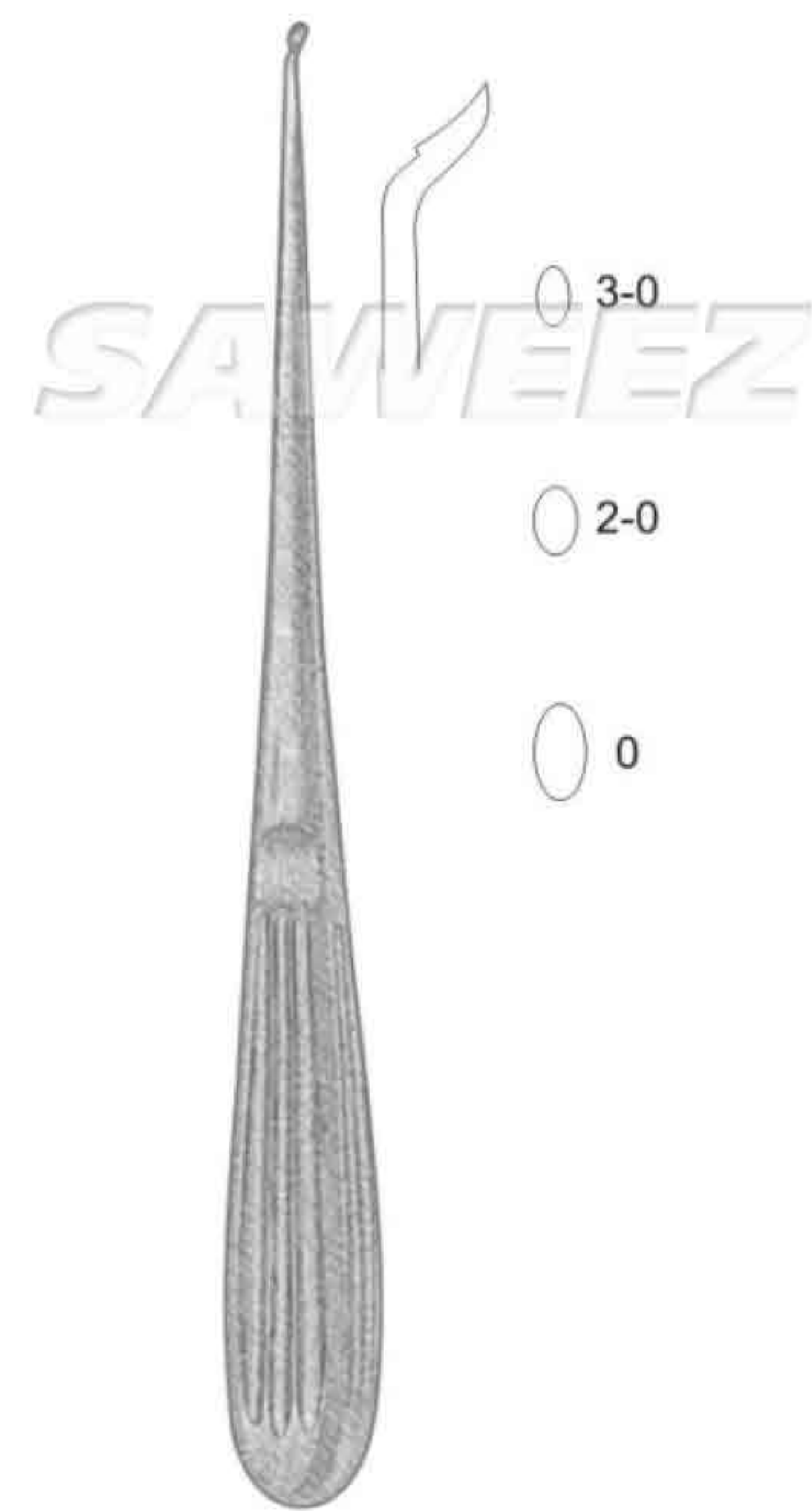
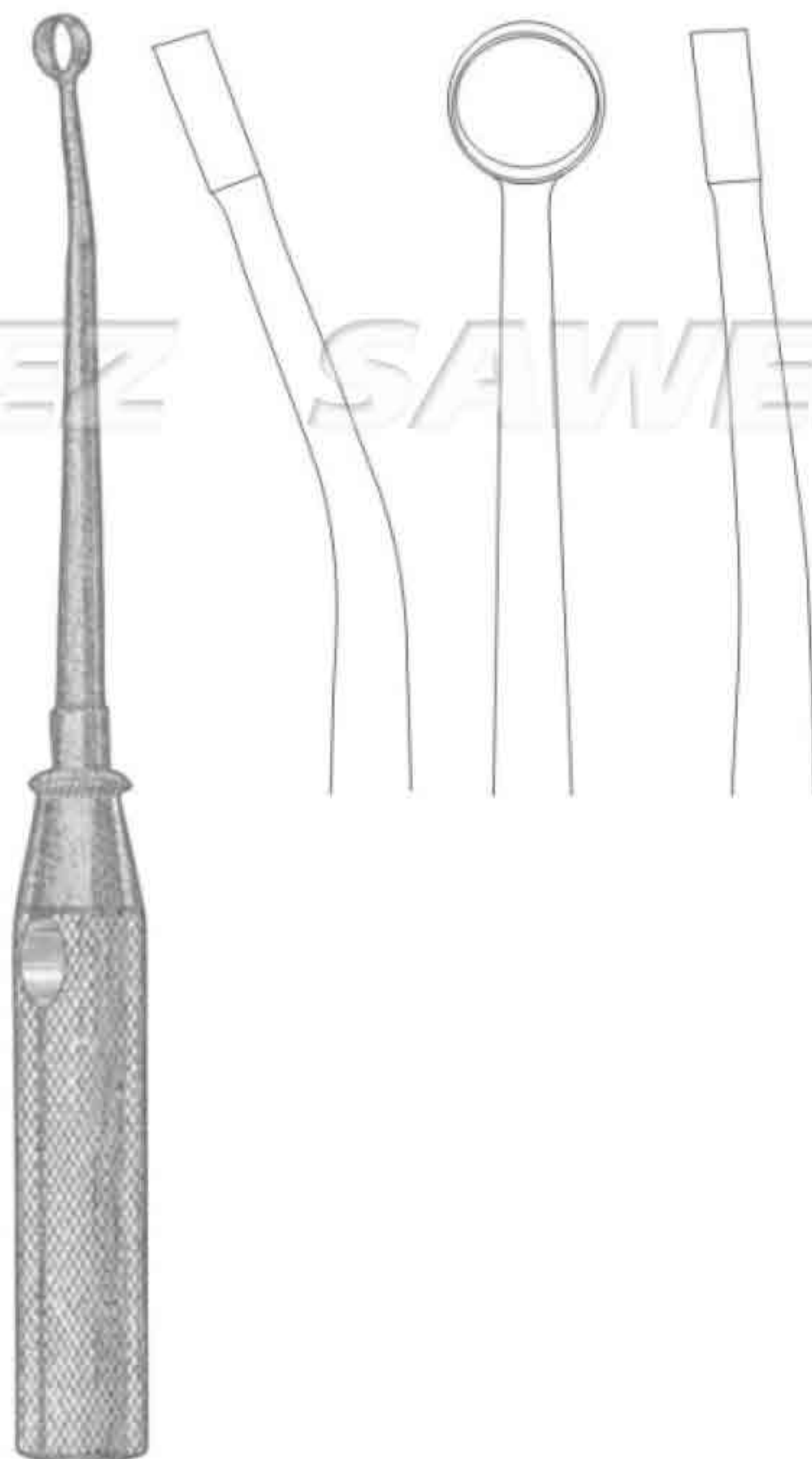
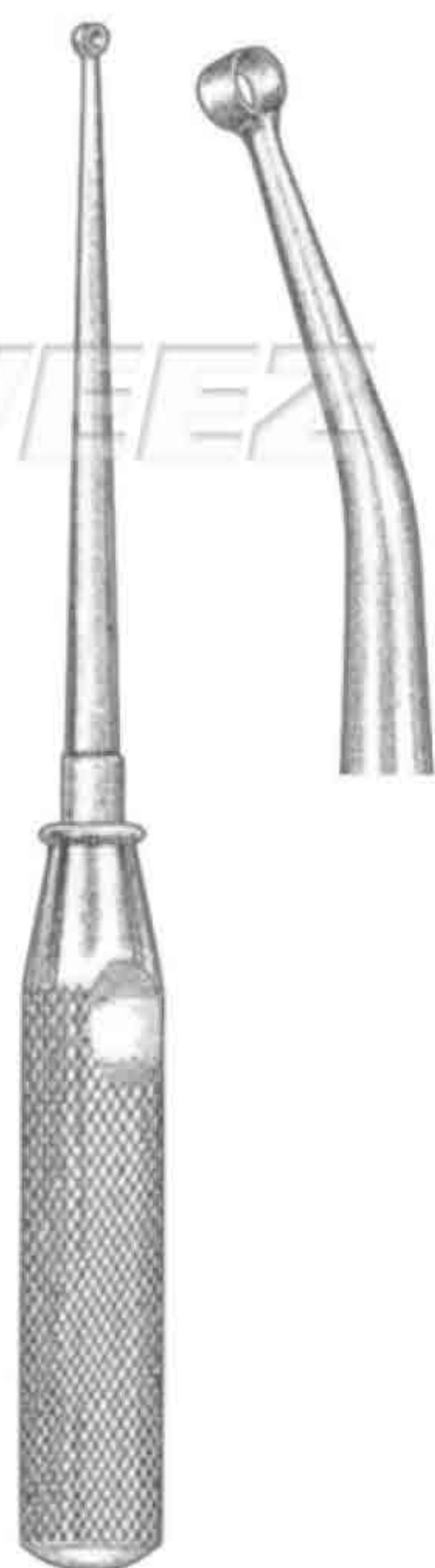
25.0 cm / 10", 4 x 10 mm cup

- SSC-23-14-52 - Straight
- SSC-23-14-53 - Reverse angled
- SSC-23-14-54 - Angled

SAWEEZ SAWEEZ SAWEEZ SAWEEZ



SAWEEZ SAWEEZ SAWEEZ SAWEEZ



Cone Ring Curettes
23.0 cm / 9"

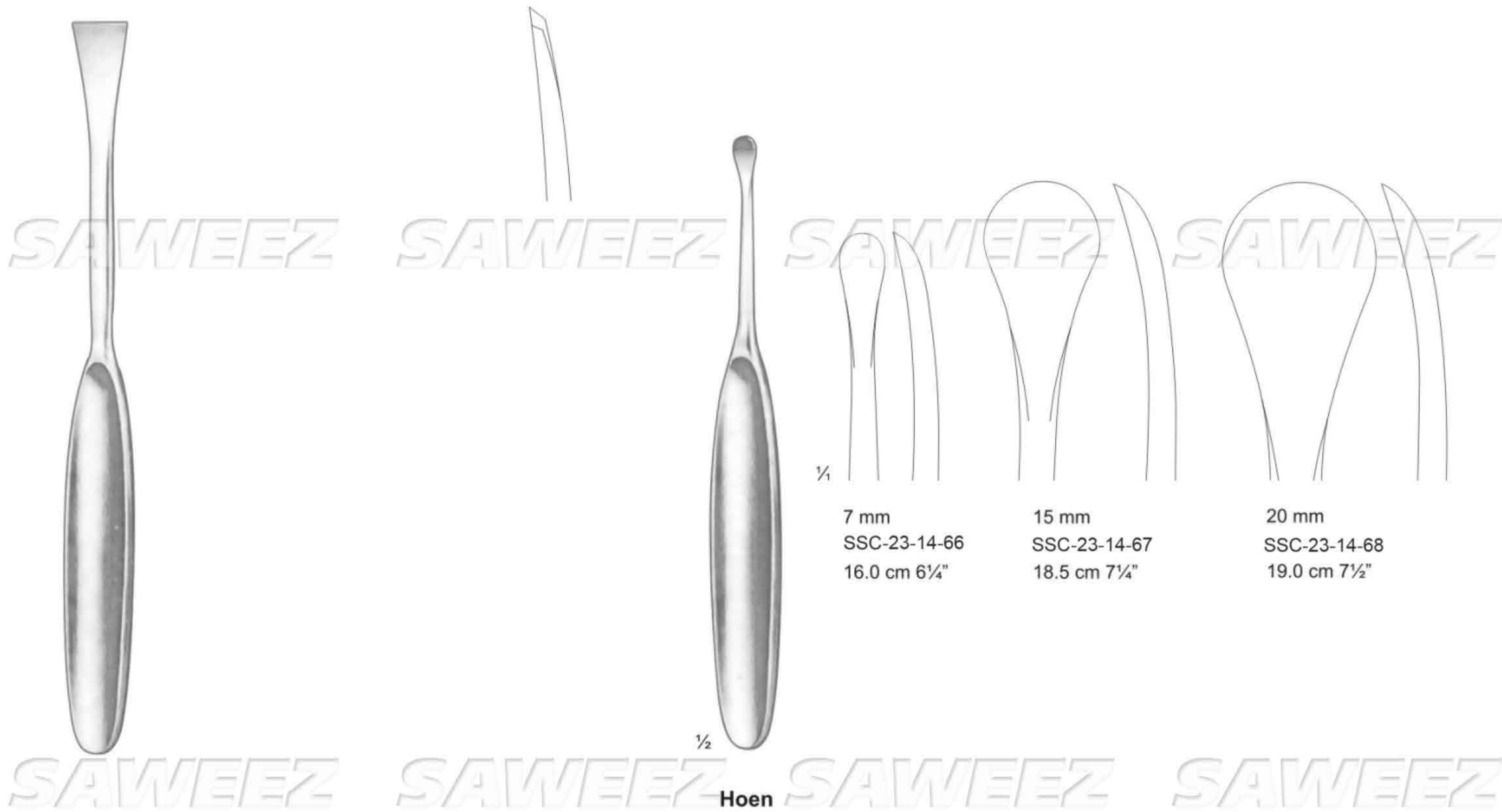
- SSC-23-14-55 - Straight, Size 1, 8mm diameter
- SSC-23-14-56 - Straight, Size 2, 6mm diameter
- SSC-23-14-57 - Straight, Size 3, 3mm diameter
- SSC-23-14-58 - Angular, Size 1, 8mm diameter
- SSC-23-14-59 - Angular, Size 2, 6mm diameter
- SSC-23-14-60 - Angular, Size 3, 3mm diameter

Cone Ring Curettes
23.0 cm / 9", 8mm cup

- SSC-23-14-61 - 5° Angle
- SSC-23-14-62 - 30° Angle

Epstein Spinal Curettes
20.0 cm / 8", reverse angle

- SSC-23-14-63 - Size 3-0
- SSC-23-14-64 - Size 2-0
- SSC-23-14-65 - Size 0





SSC-23-14-72
18.0 cm / 7"

1/2

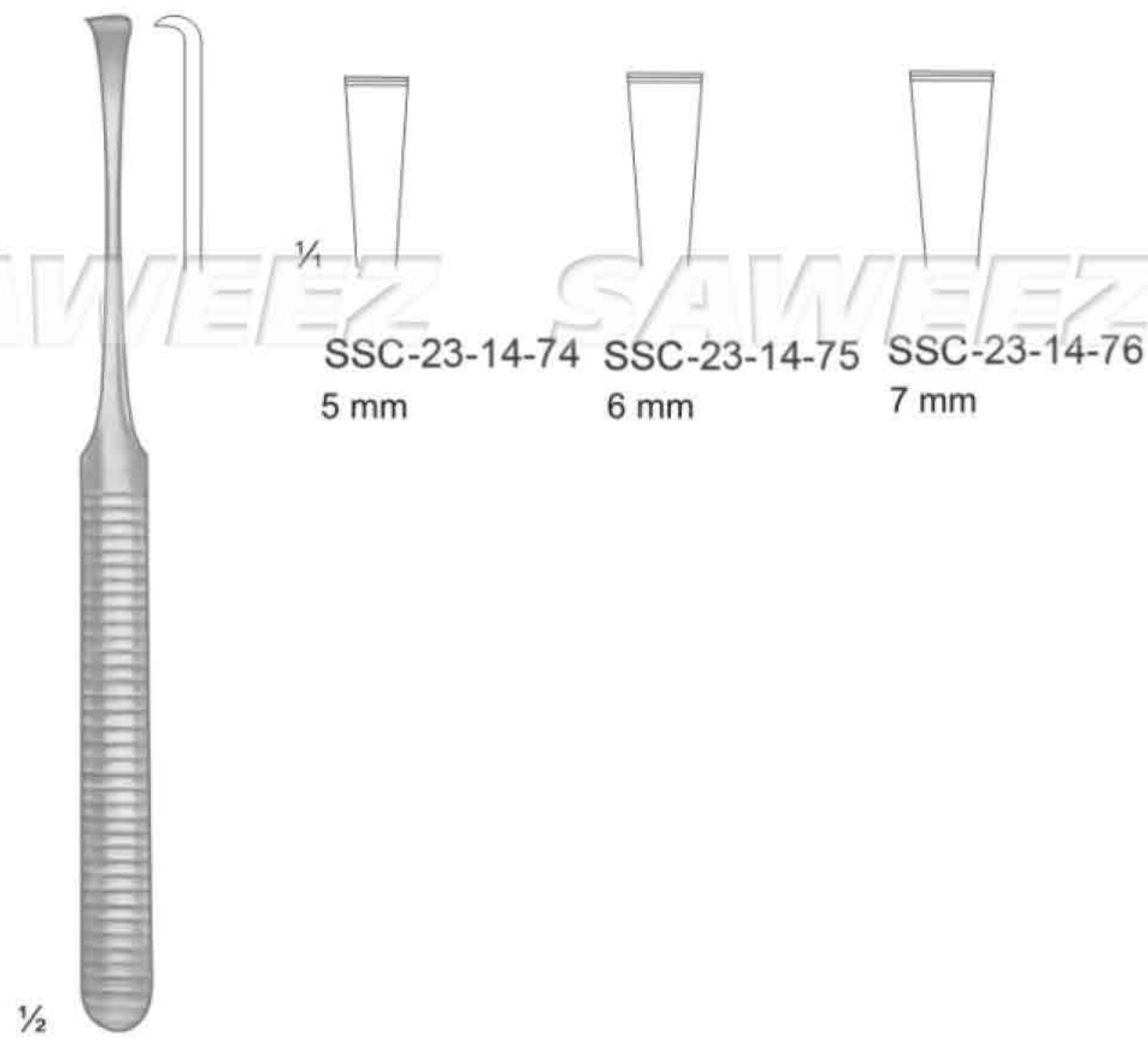
Langenbeck



SSC-23-14-73
19.0 cm / 7 1/2"

1/2

Langenbeck



SSC-23-14-74
5 mm

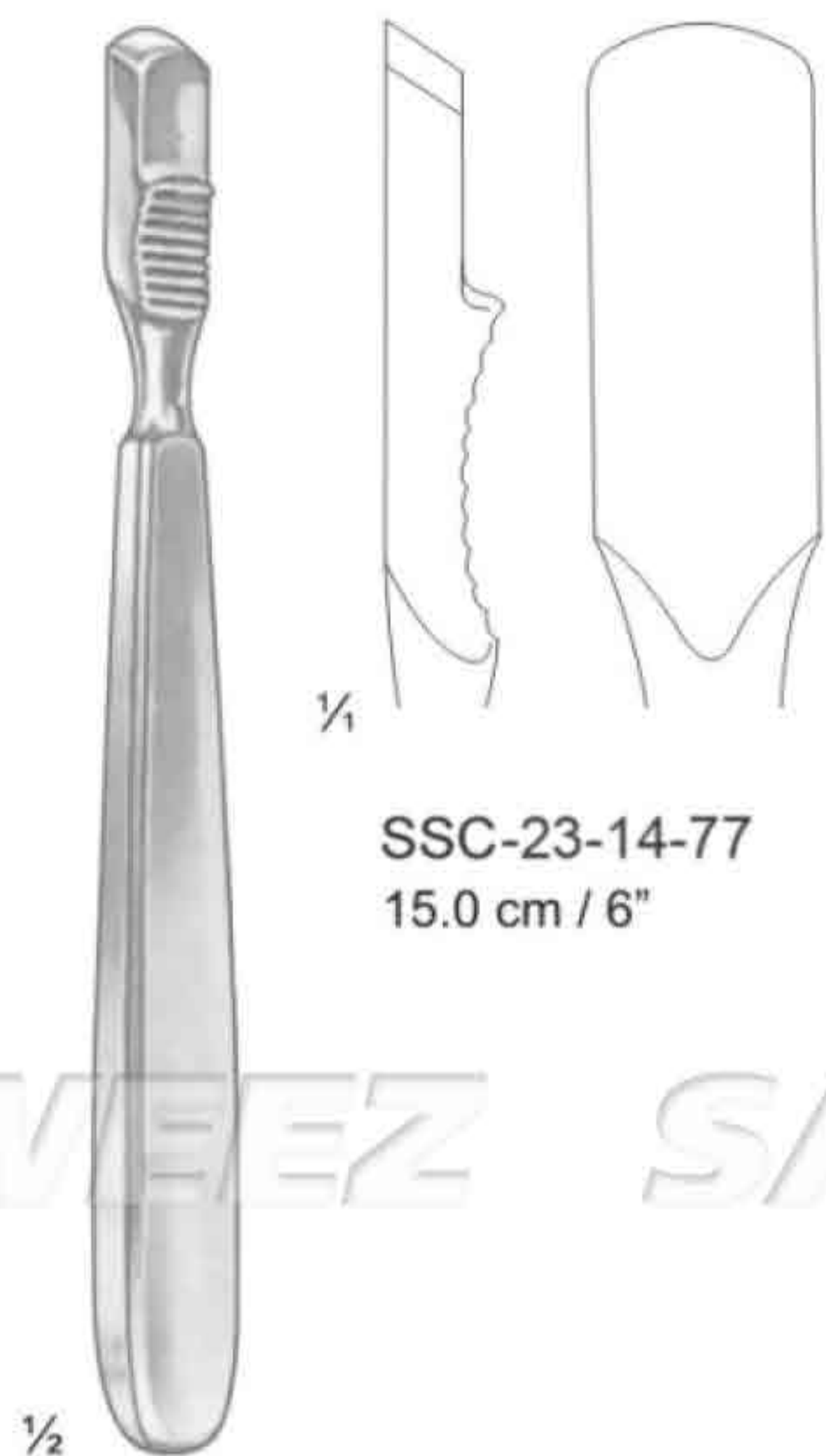
SSC-23-14-75
6 mm

SSC-23-14-76
7 mm

1/2

16.0 cm / 6 1/4"

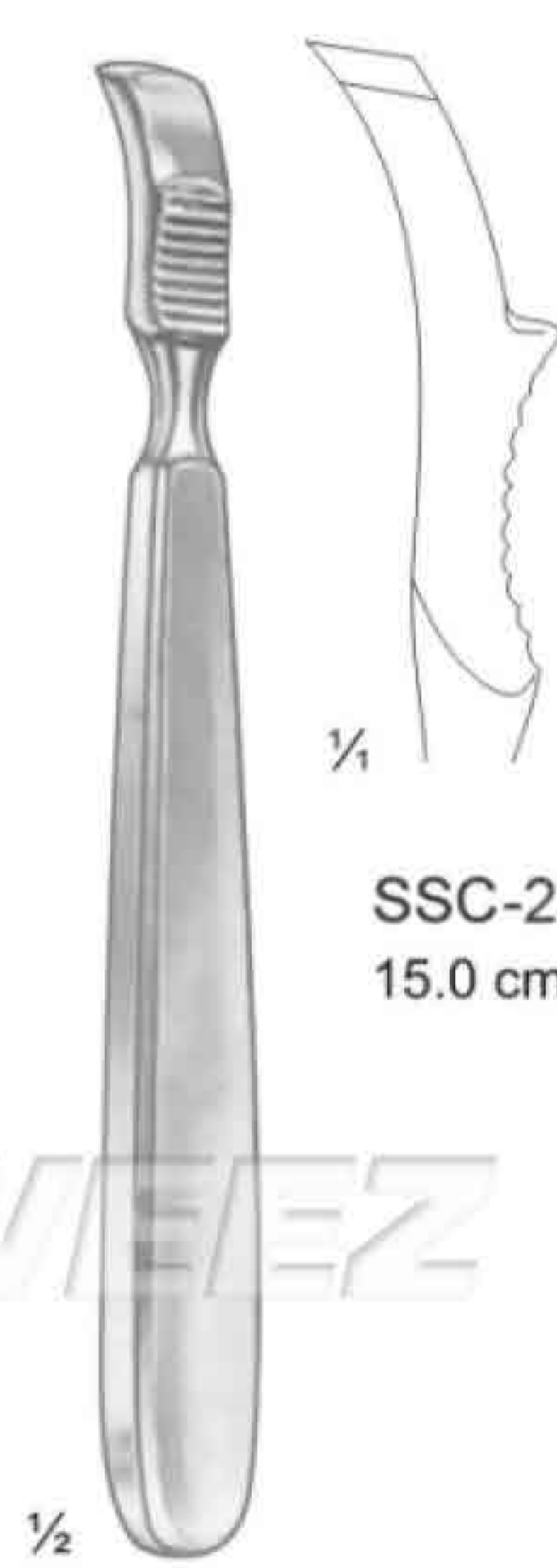
SAWEEZ SAWEEZ SAWEEZ SAWEEZ



SSC-23-14-77
15.0 cm / 6"

1/2

Farabeuf



SSC-23-14-78
15.0 cm / 6"

1/2

Farabeuf

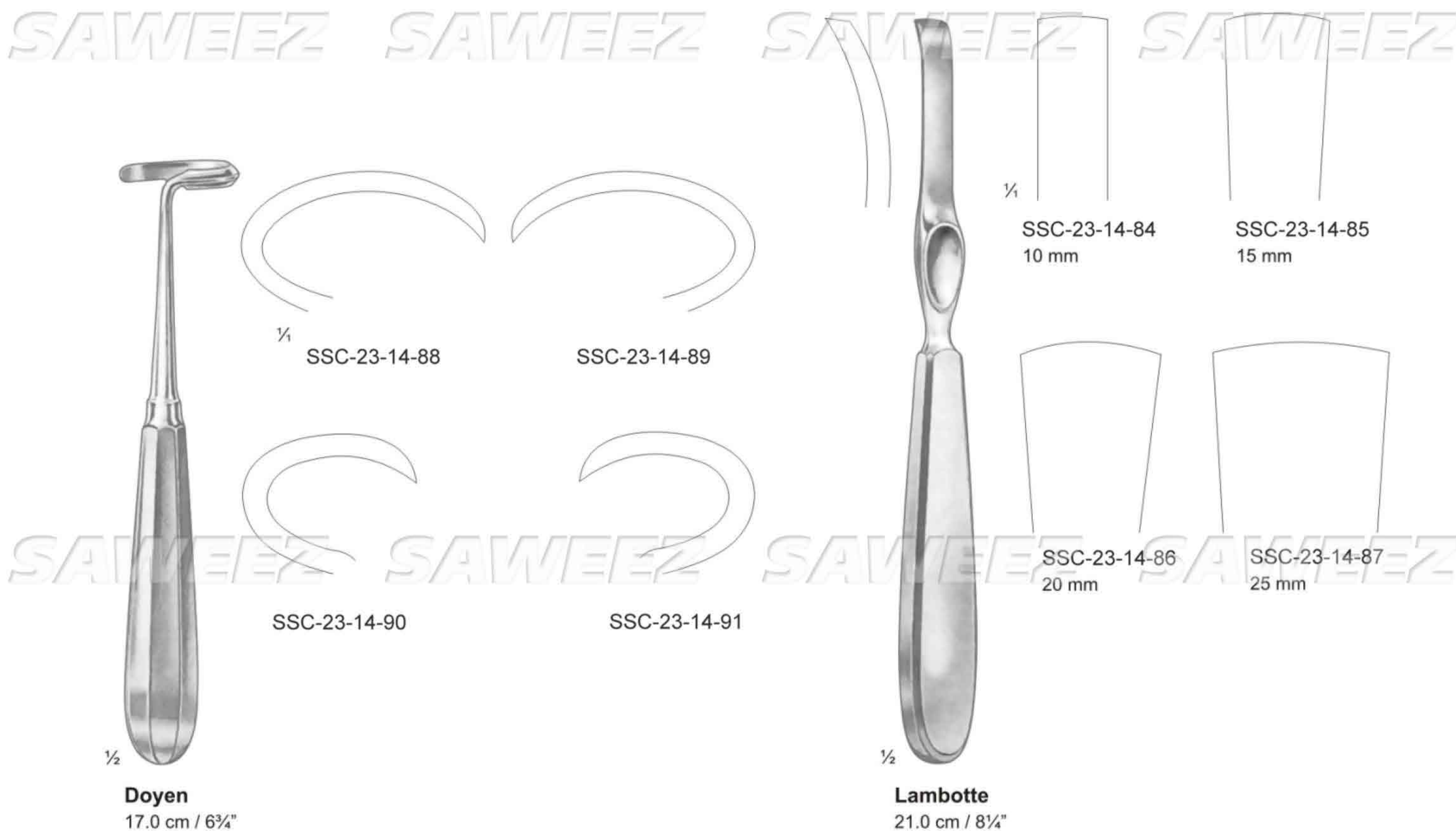
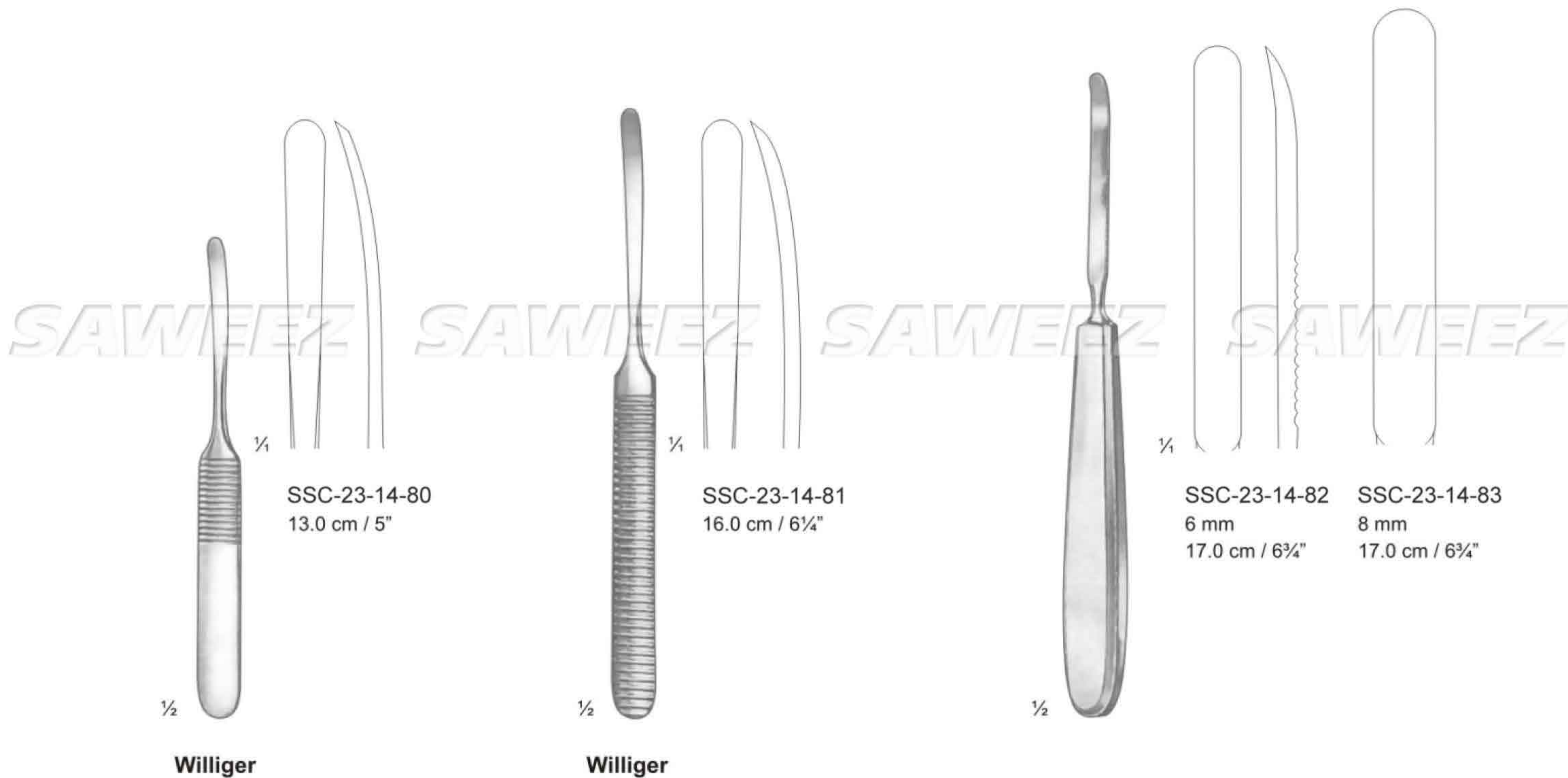


SSC-23-14-79
21.0 cm / 8 1/4"

1/2

Sedillot

SAWEEZ SAWEEZ SAWEEZ SAWEEZ





1/2

Semb



1/2

SSC-23-14-92
17.5 cm / 7"



SSC-23-14-93
21.0 cm / 8 1/4"



SSC-23-14-94
17.5 cm / 7"



SSC-23-14-95
21.0 cm / 8 1/4"

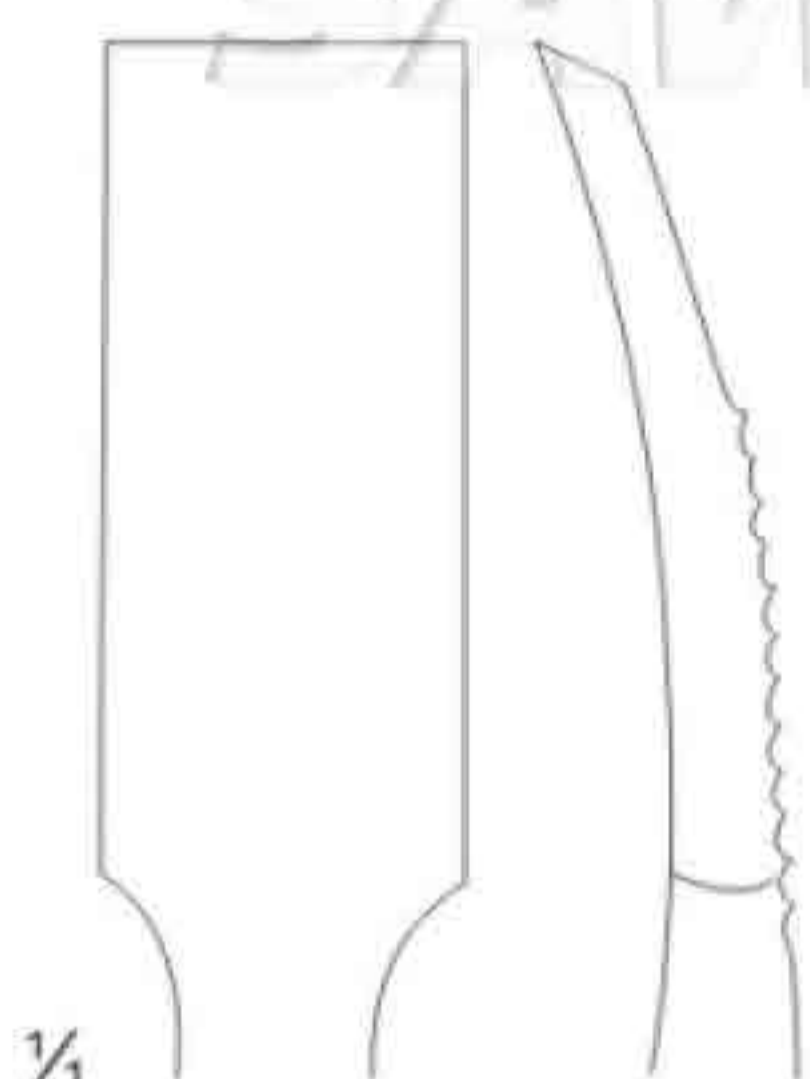


SSC-23-14-96
20.5 cm / 8"



1/2

Alexander



1/4

SSC-23-14-97
20.0 cm / 8"

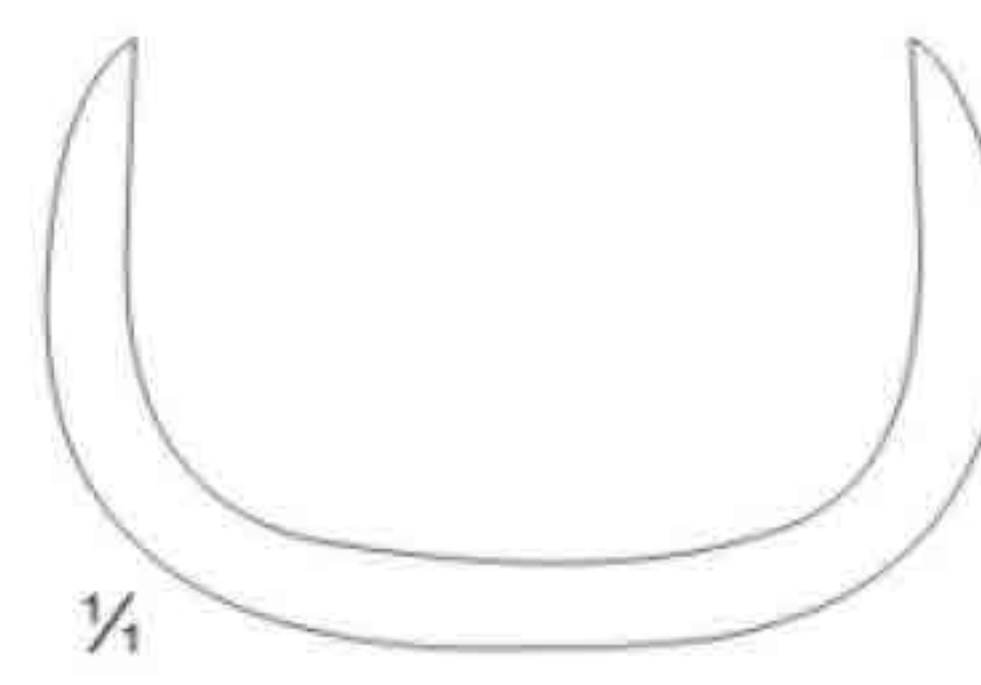


1/2

Matson



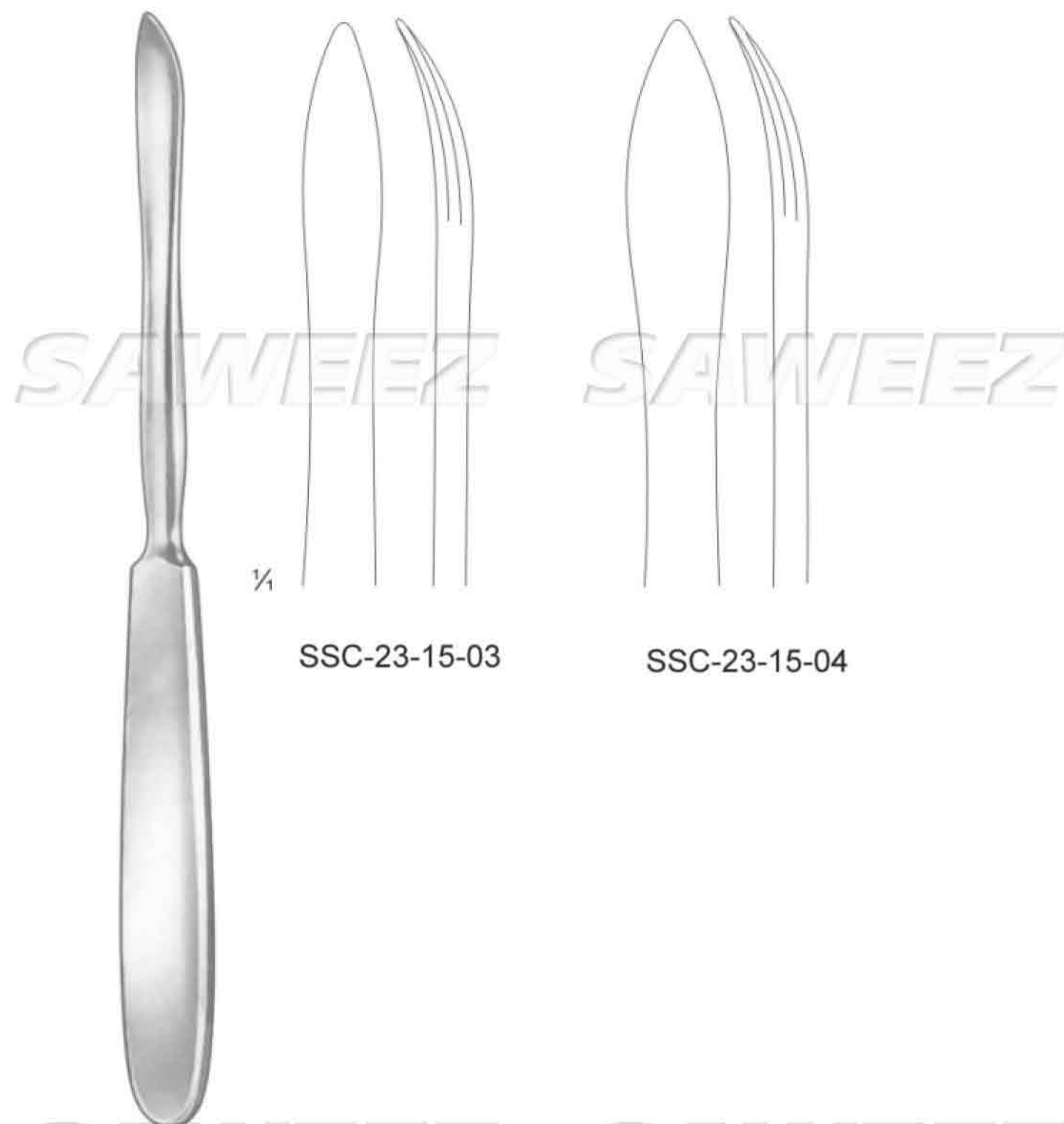
SSC-23-14-98
22.0 cm / 8 3/4"



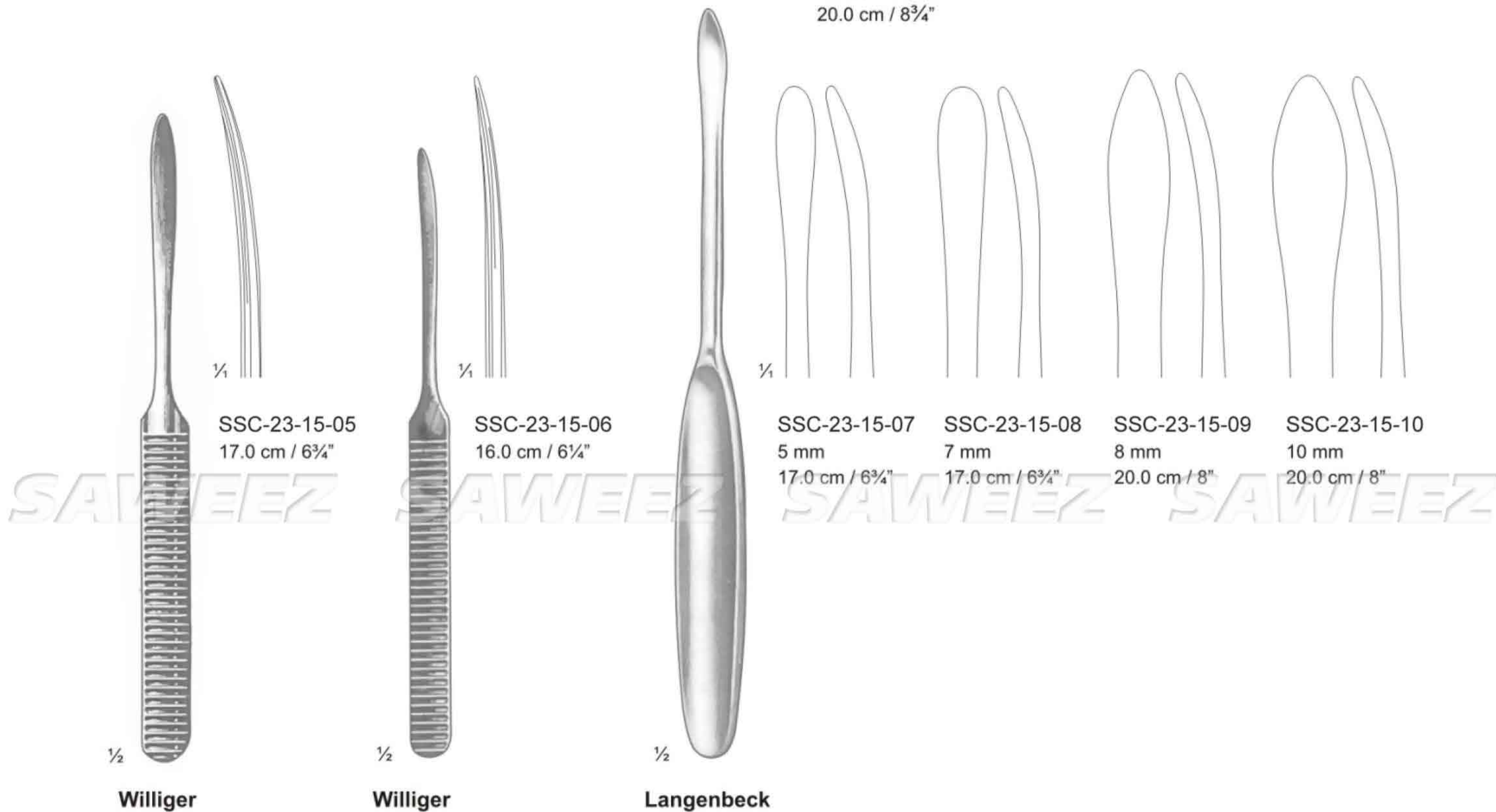
1/4



Adson
17.0 cm / 6 3/4"



Langenbeck
20.0 cm / 8 3/4"



Williger

Williger

Langenbeck



SSC-23-15-11
17.5 cm / 6 3/4"

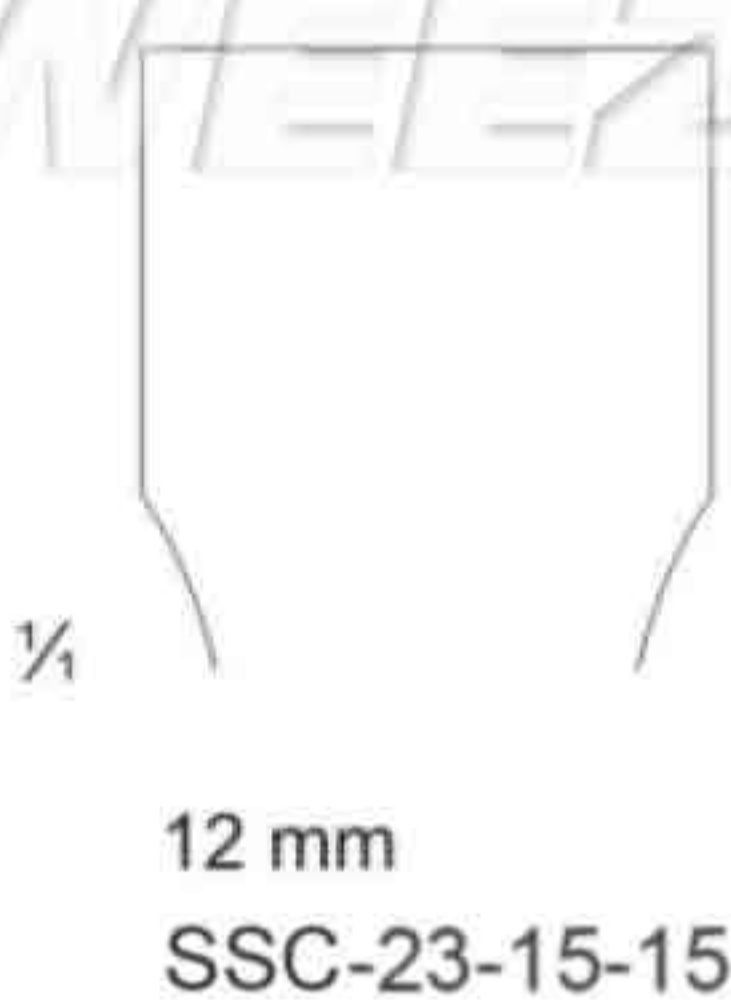
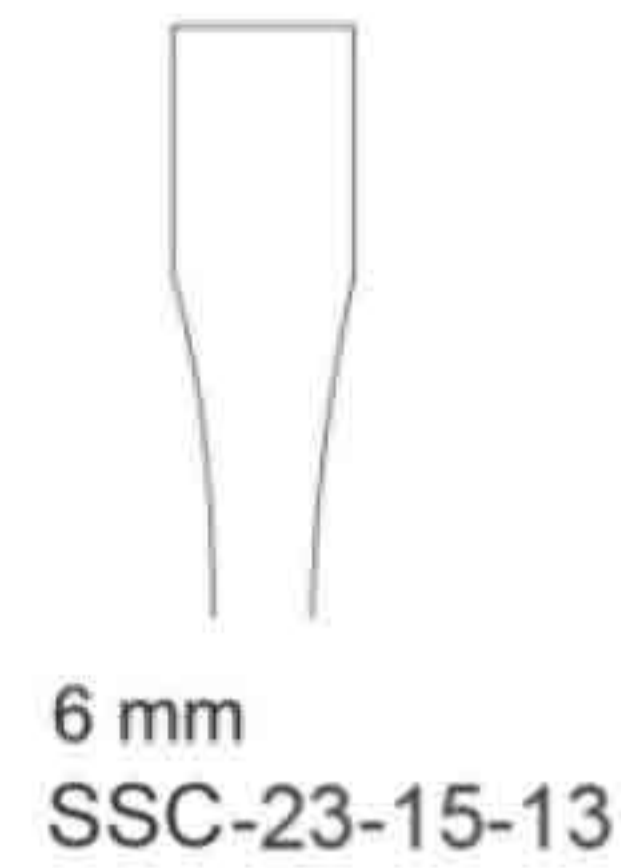
extremely lightweight



Micro Elevator
SSC-23-15-12
16.0 cm / 6 1/4"



Key
19.0 cm / 7 1/2"



SSC-23-15-17
16.0 cm / 6 1/4"



SSC-23-15-18
21.0 cm / 8 1/4"

Alderdyce

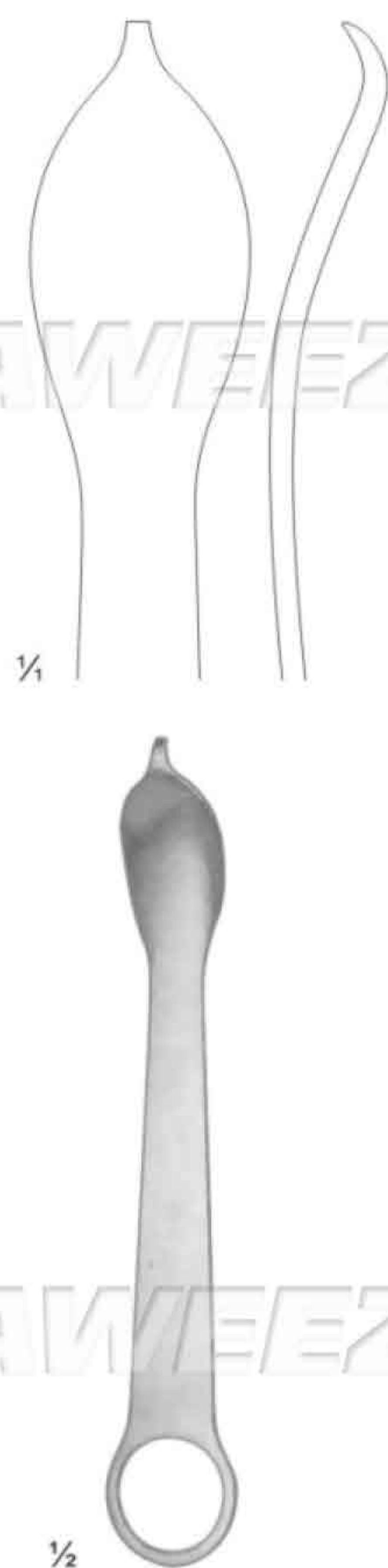
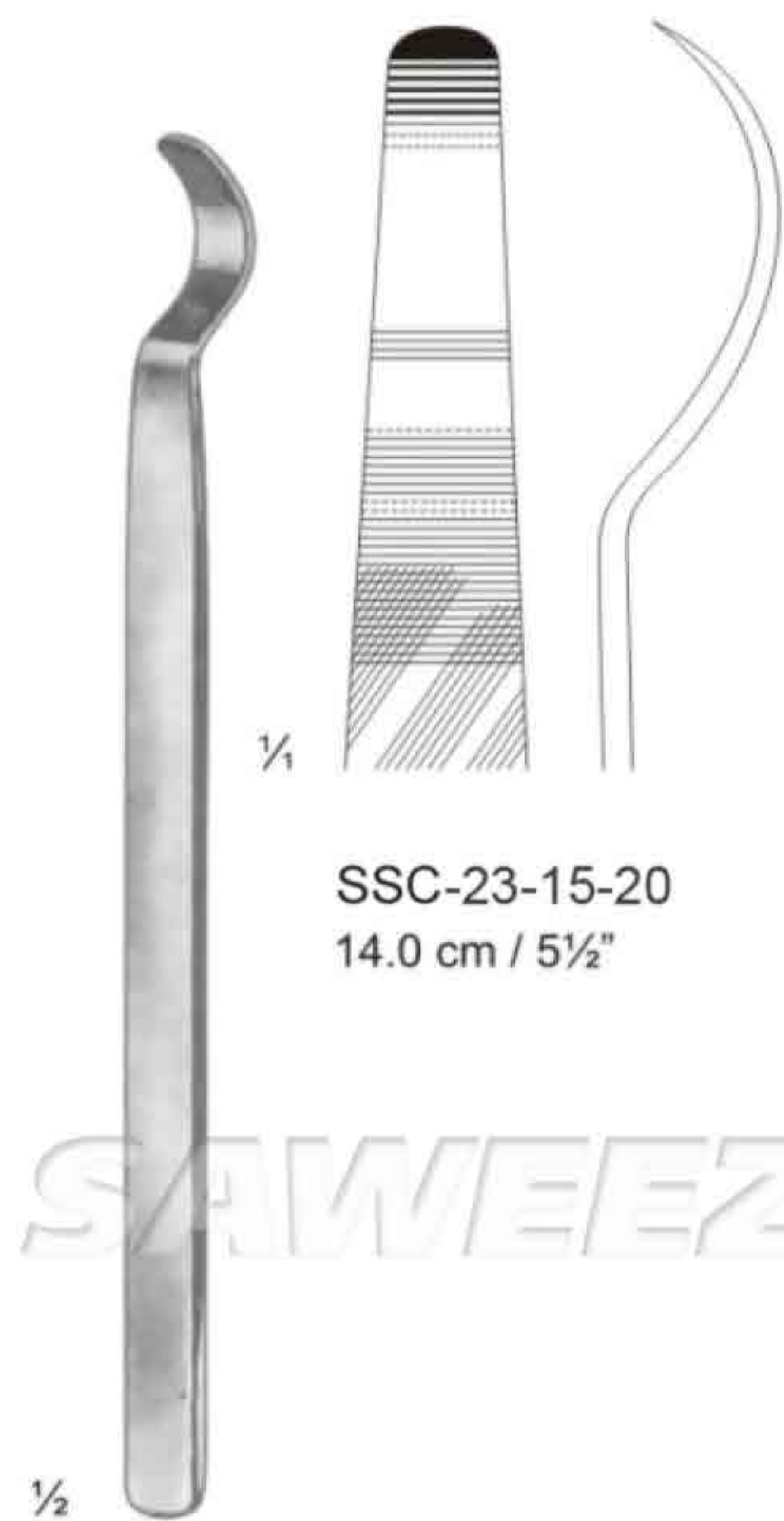


McDonald
SSC-23-15-19
19.0 cm / 8 1/2"



SAWEEZ SAWEEZ SAWEEZ SAWEEZ

SAWEEZ SAWEEZ SAWEEZ SAWEEZ



SAWEEZ SAWEEZ SAWEEZ SAWEEZ



SAWEEZ SAWEEZ SAWEEZ SAWEEZ





SAWEEZ SAWEEZ SAWEEZ SAWEEZ





1/3

Bennett
SSC-23-15-34
24.0 cm / 9 1/2"



1/3

Blount
SSC-23-15-35
26.0 cm / 10 1/4"



1/3

Blount
SSC-23-15-36
26.0 cm / 10 1/4"

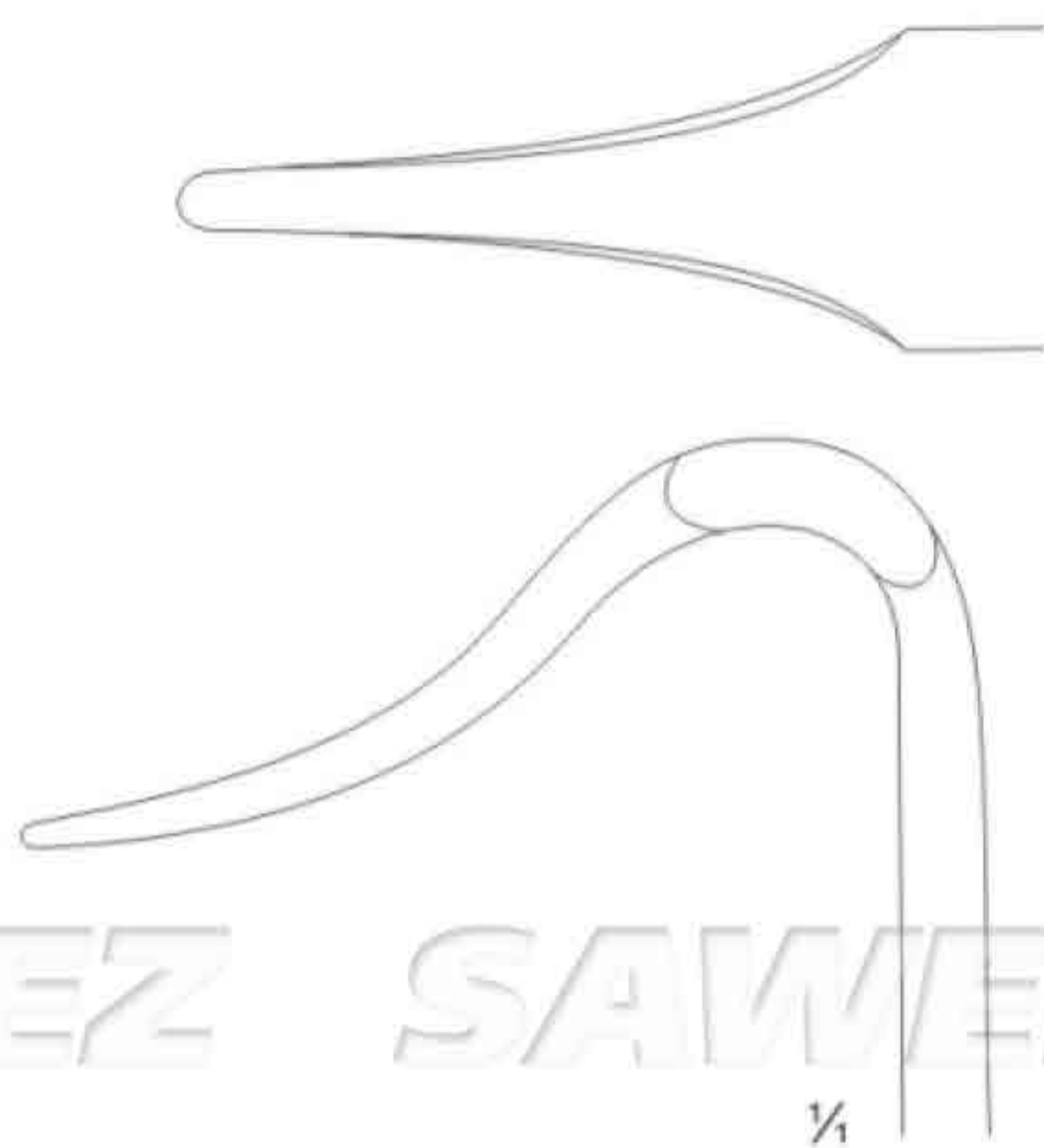
SAWEEZ SAWEEZ SAWEEZ SAWEEZ

Spinal Retractors



1/3

Blount Kneel Retractors
SSC-23-15-37
17.5 cm / 7"

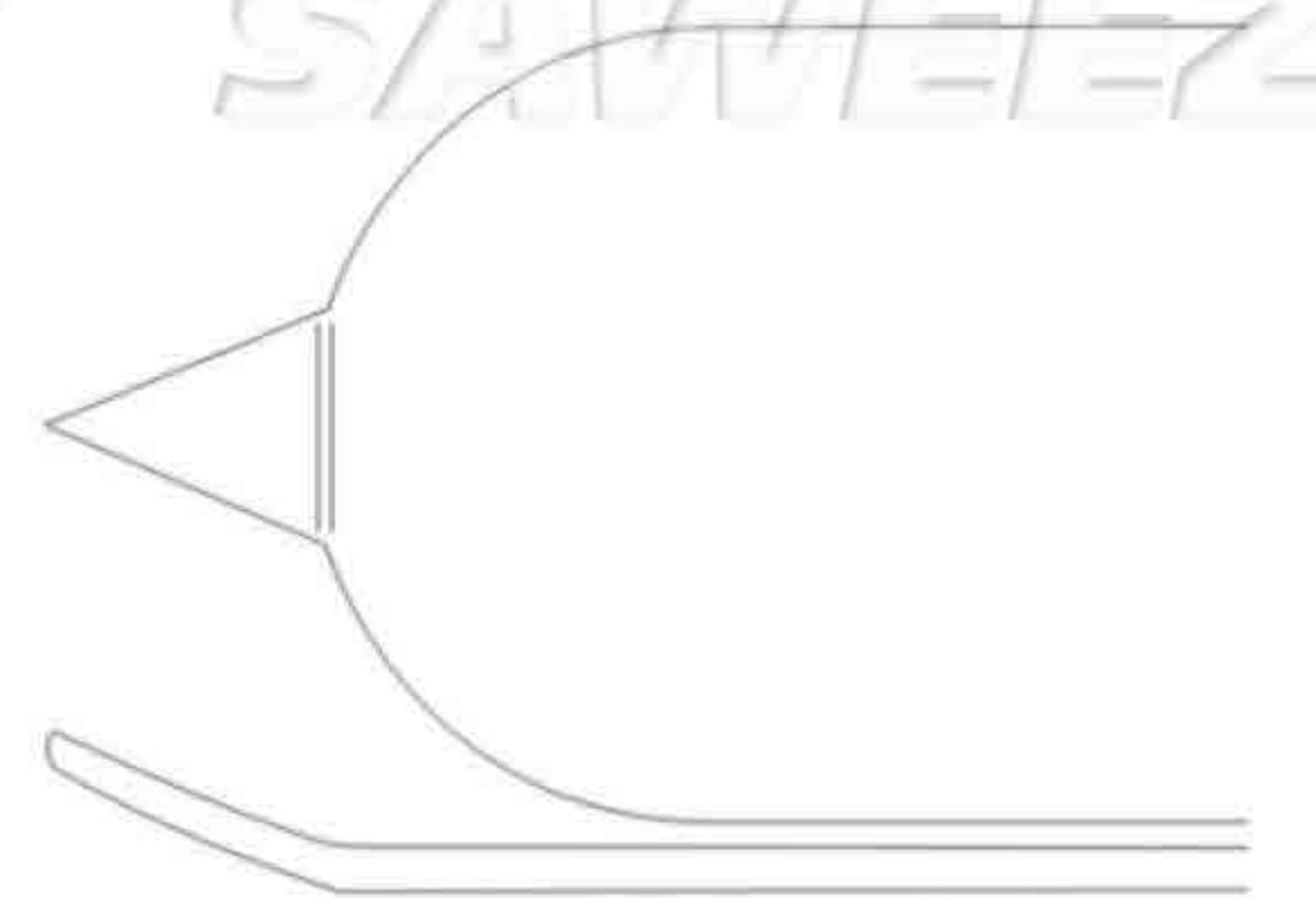


1/4

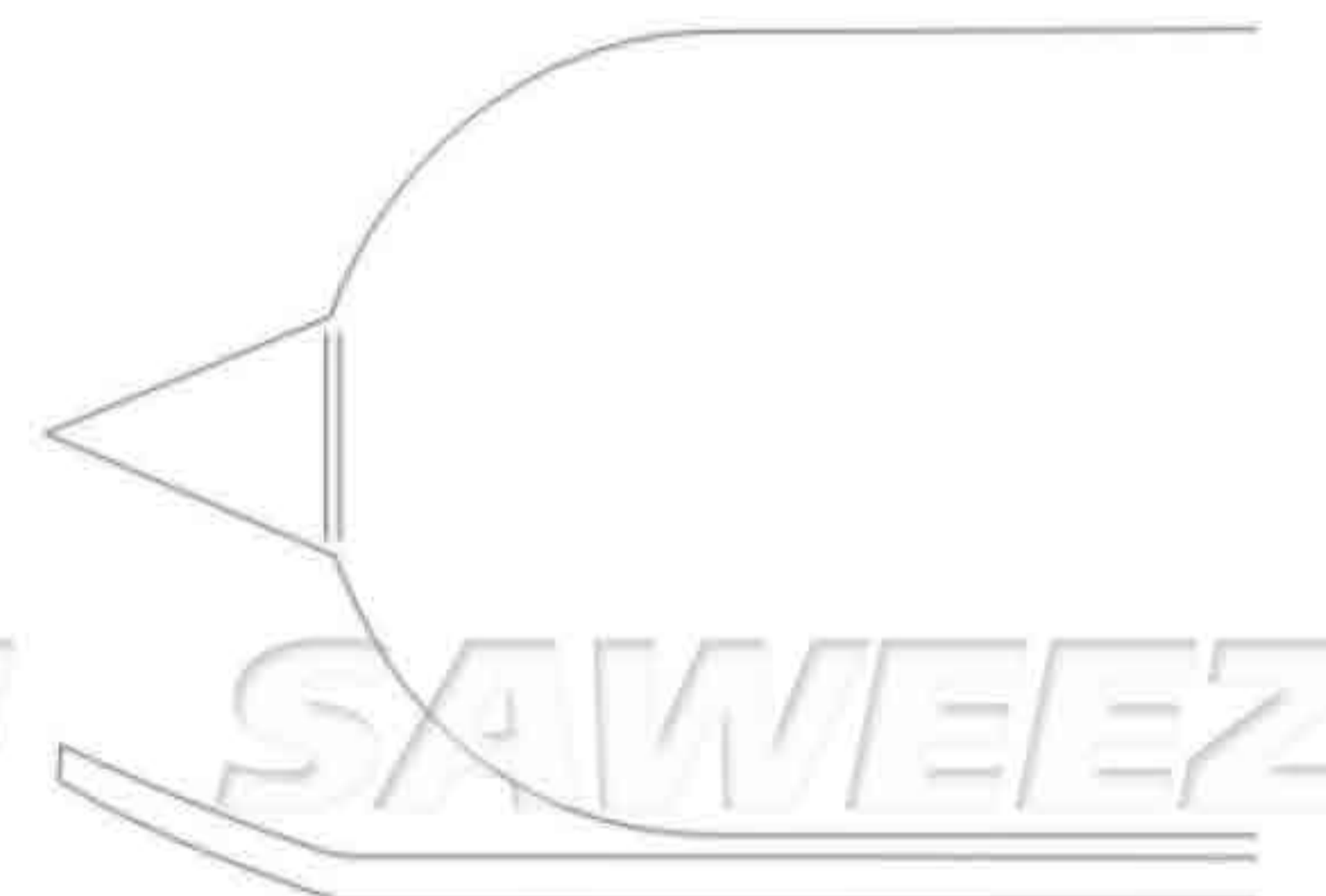


1/3

Taylor Spinal Retractors
16.5 cm / 6 1/2"
100 x 30 mm 75 x 30 mm



SSC-23-15-38
100 x 30 mm



SSC-23-15-39
75 x 30 mm

SAWEEZ SAWEEZ SAWEEZ SAWEEZ

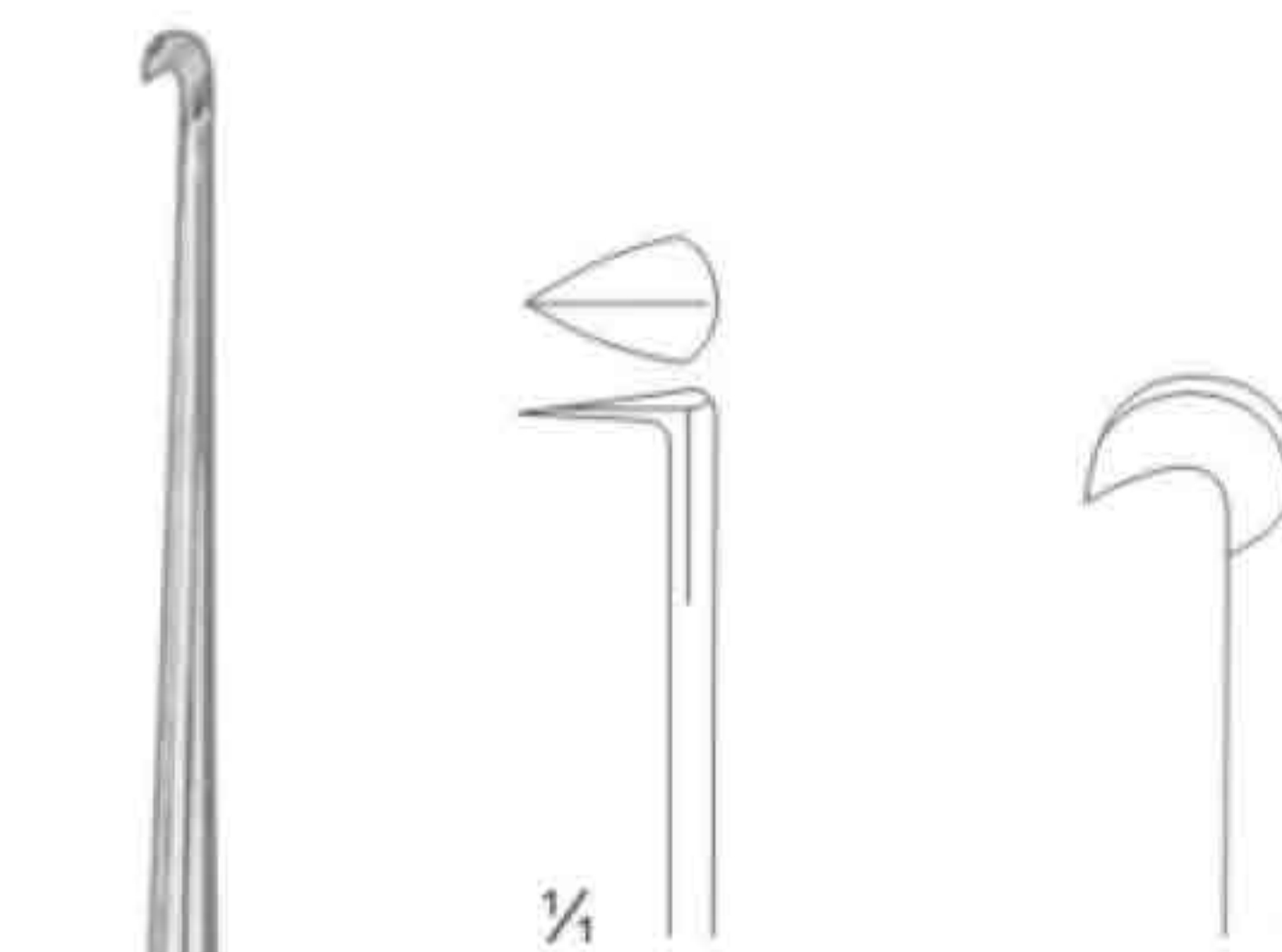


SSC-23-15-40
left cutting

SSC-23-15-41
right cutting

1/2

Mod. Schweden
17.0 cm / 6 3/4"



SSC-23-15-42

SSC-23-15-43

1/2

Bircher
19.0 cm / 7 1/2"



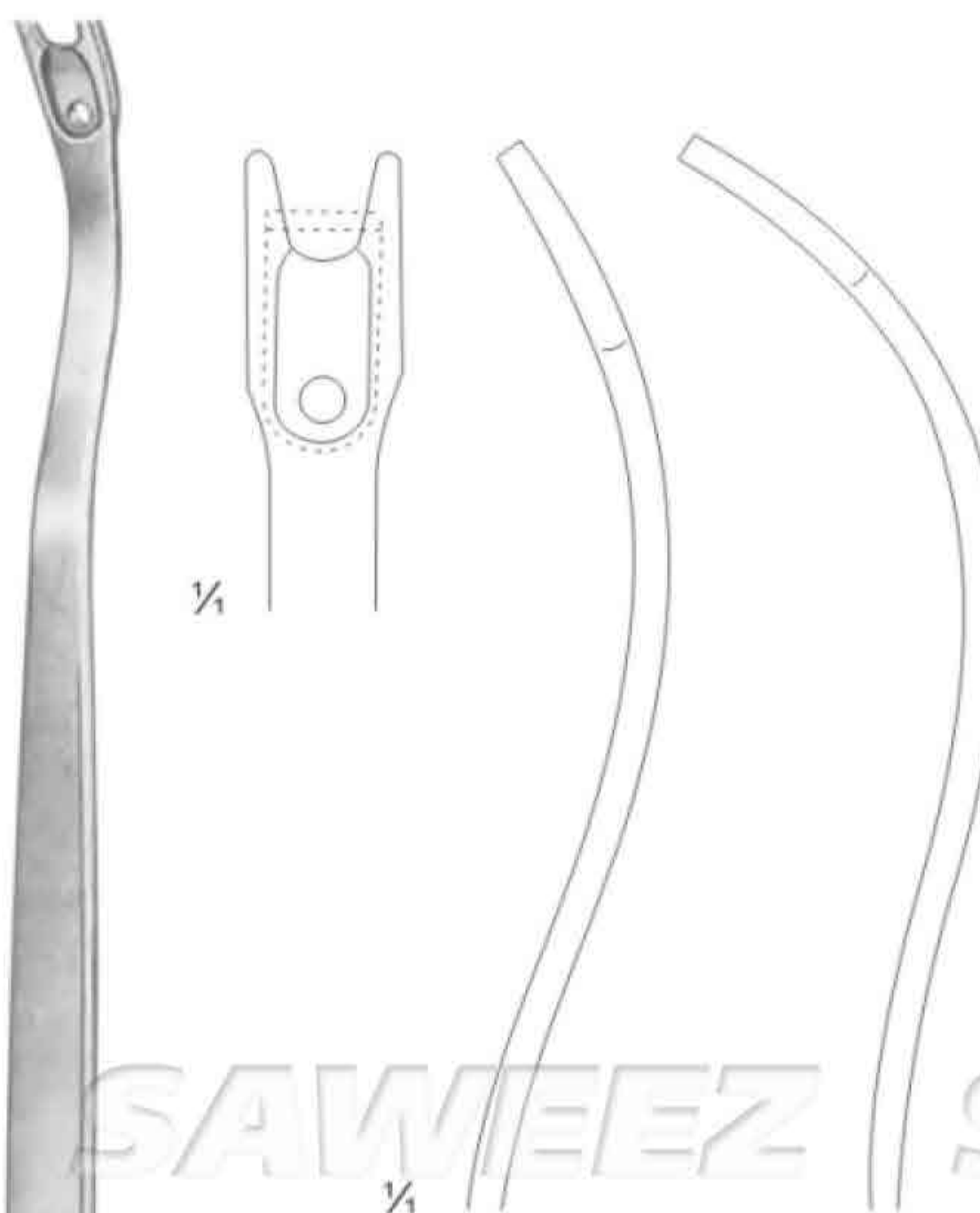
SSC-23-15-44

SSC-23-15-45

SSC-23-15-46

1/2

Smillie
17.0 cm / 6 3/4"



1/4

Slightly curved
SSC-23-15-47

Strongly curved
SSC-23-15-48

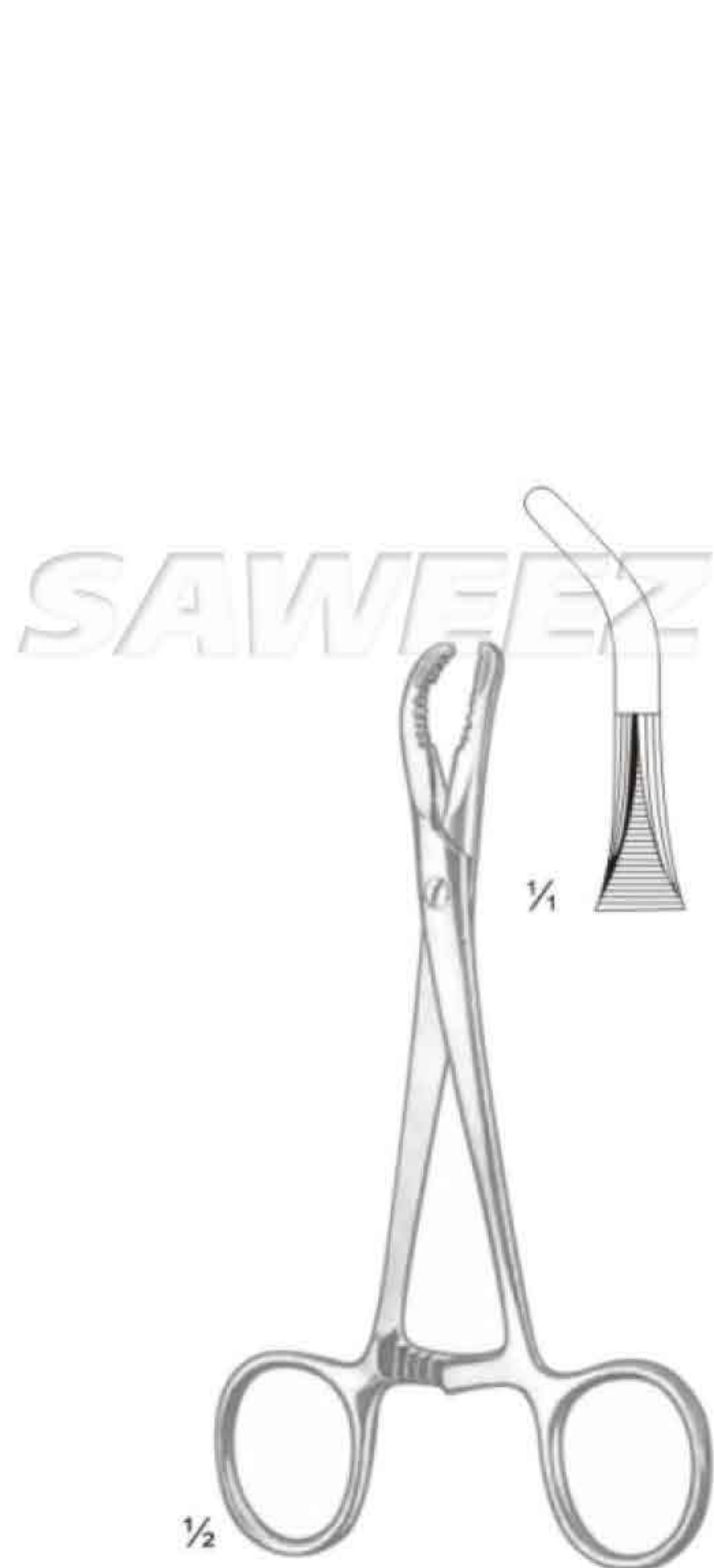
1/2

Stryker-Scholl
19.0 cm / 7 1/2"

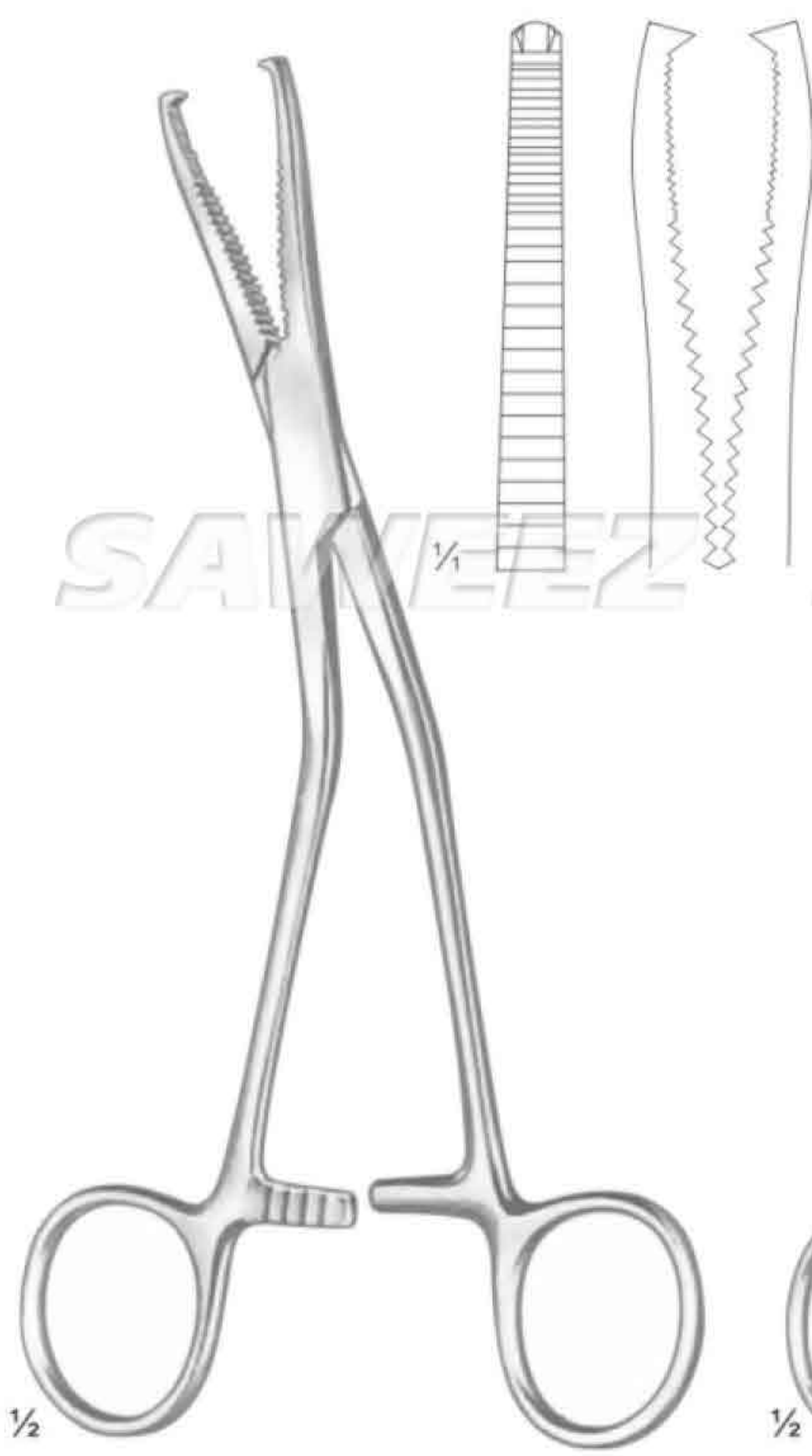


1/4

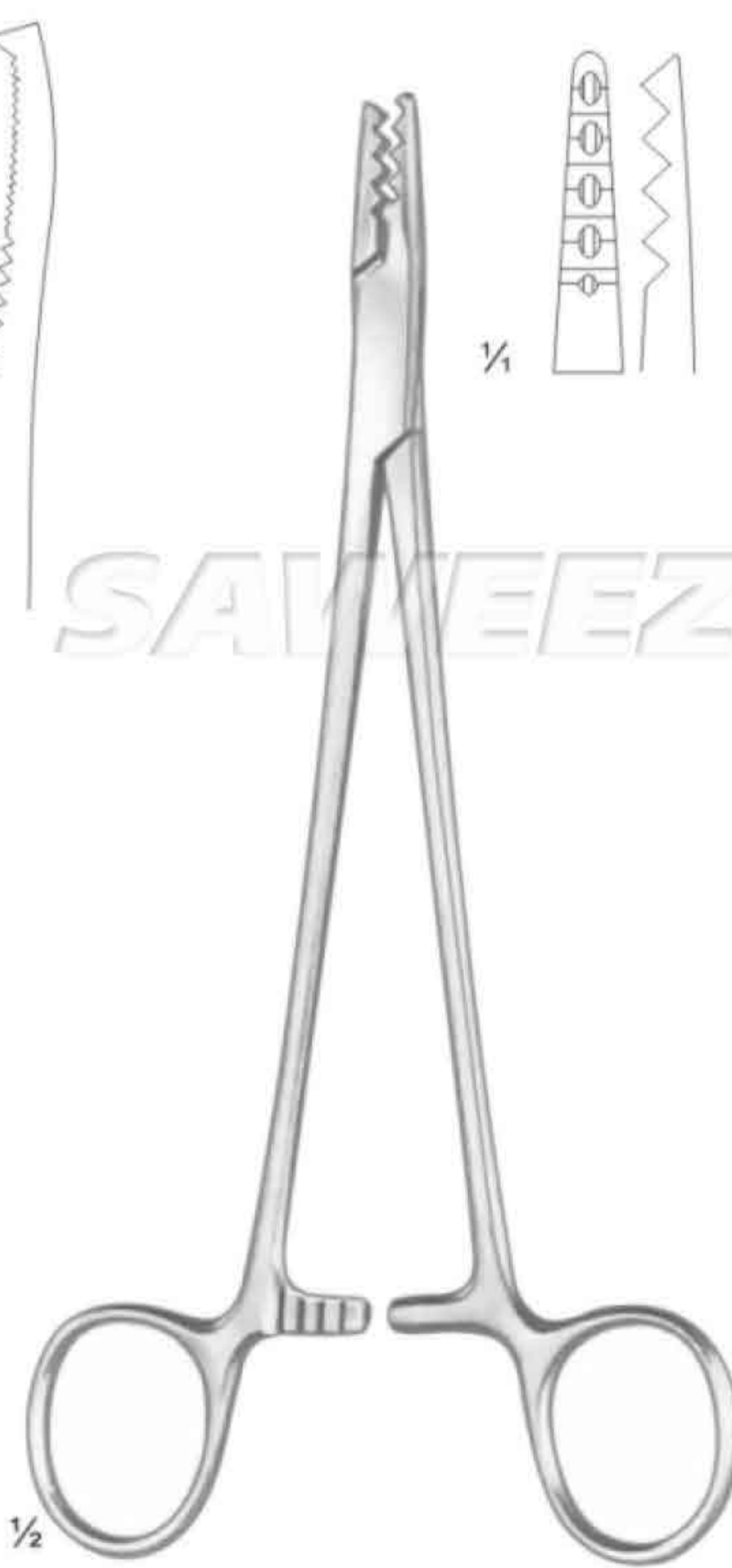
SSC-23-15-49
spare blades



SSC-23-15-50
13.5 cm / 5 1/4"



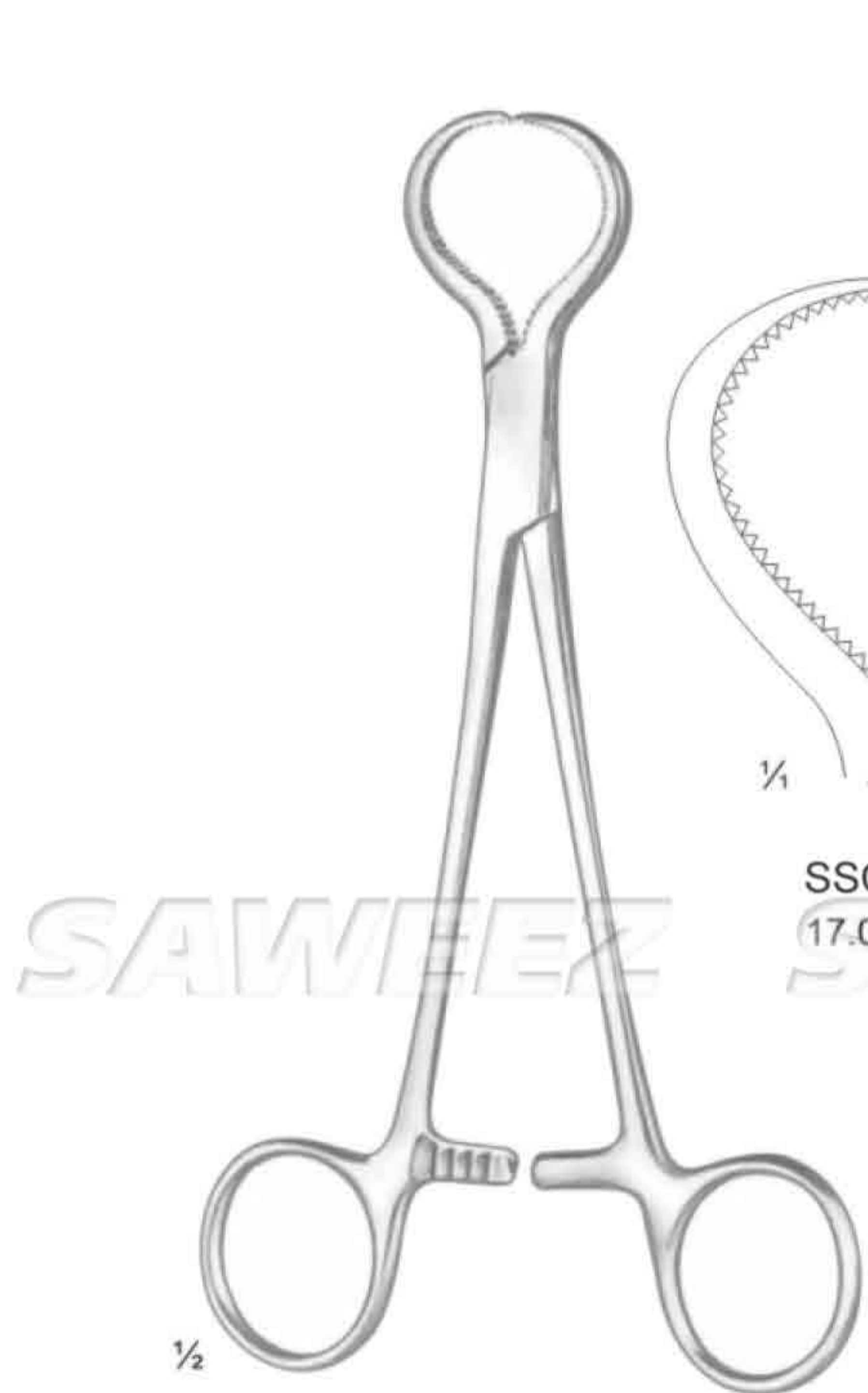
Dingmann
SSC-23-15-51
19.0 cm / 7 1/2"



Special Model
SSC-23-15-52
19.0 cm / 7 1/2"



SSC-23-15-53



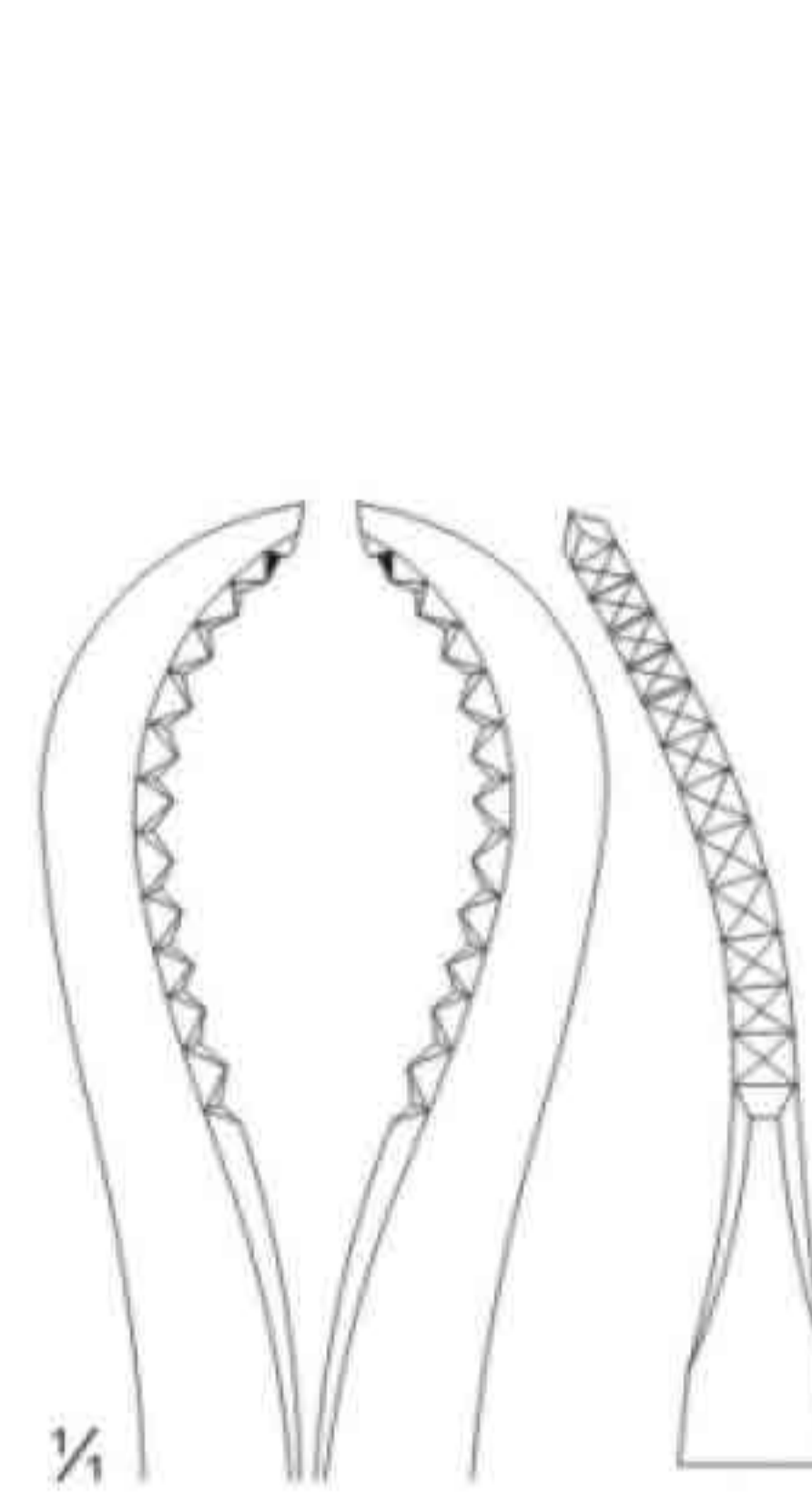
Lewin



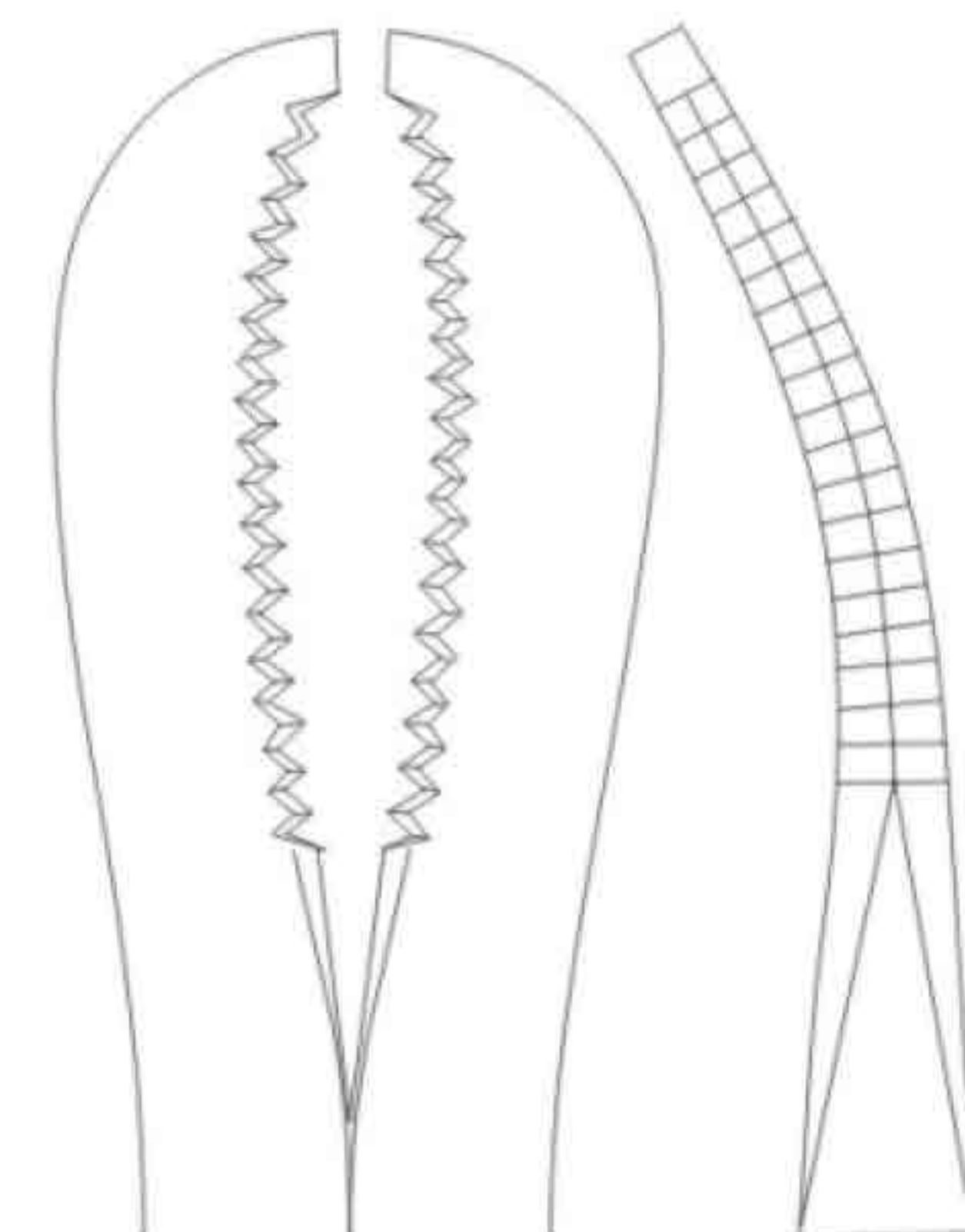
SSC-23-15-54
17.0 cm / 7"



SSC-23-15-55
16.0 cm / 6 1/4"



SSC-23-15-56
16.0 cm / 9 1/2"





SSC-23-15-57
14.0 cm / 5½"



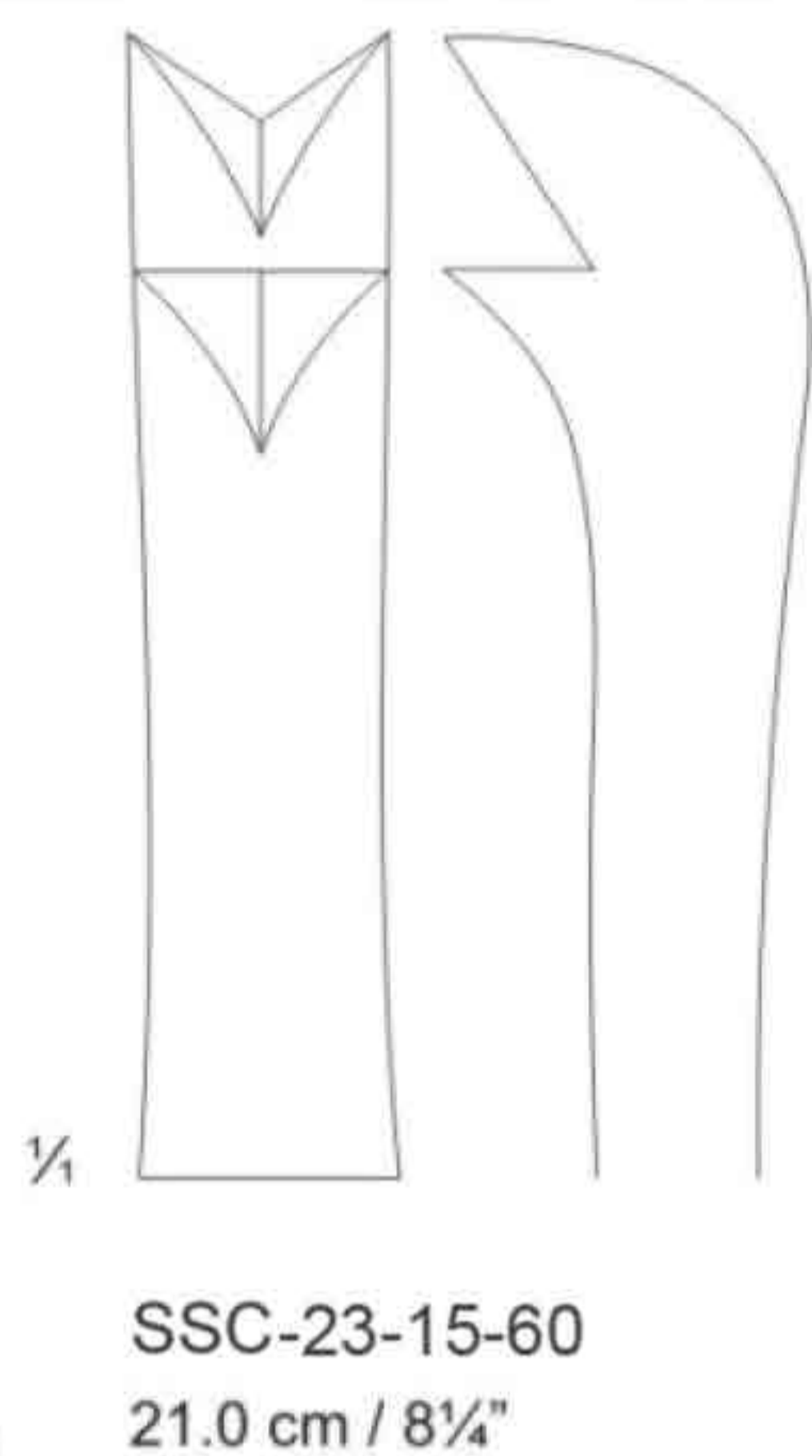
SSC-23-15-58
13.5 cm / 5¼"



Langenbeck
SSC-23-15-59
21.0 cm / 8¼"



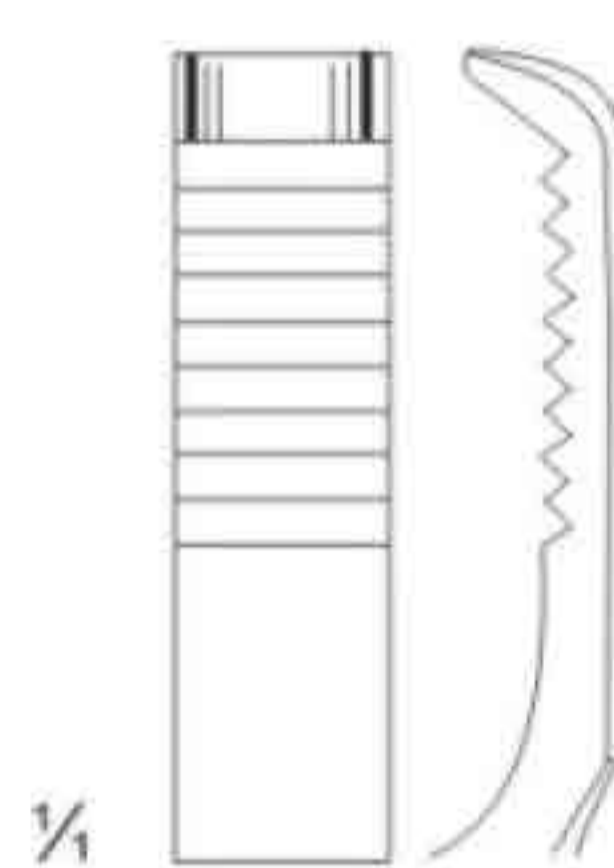
Fergusson



SSC-23-15-60
21.0 cm / 8¼"



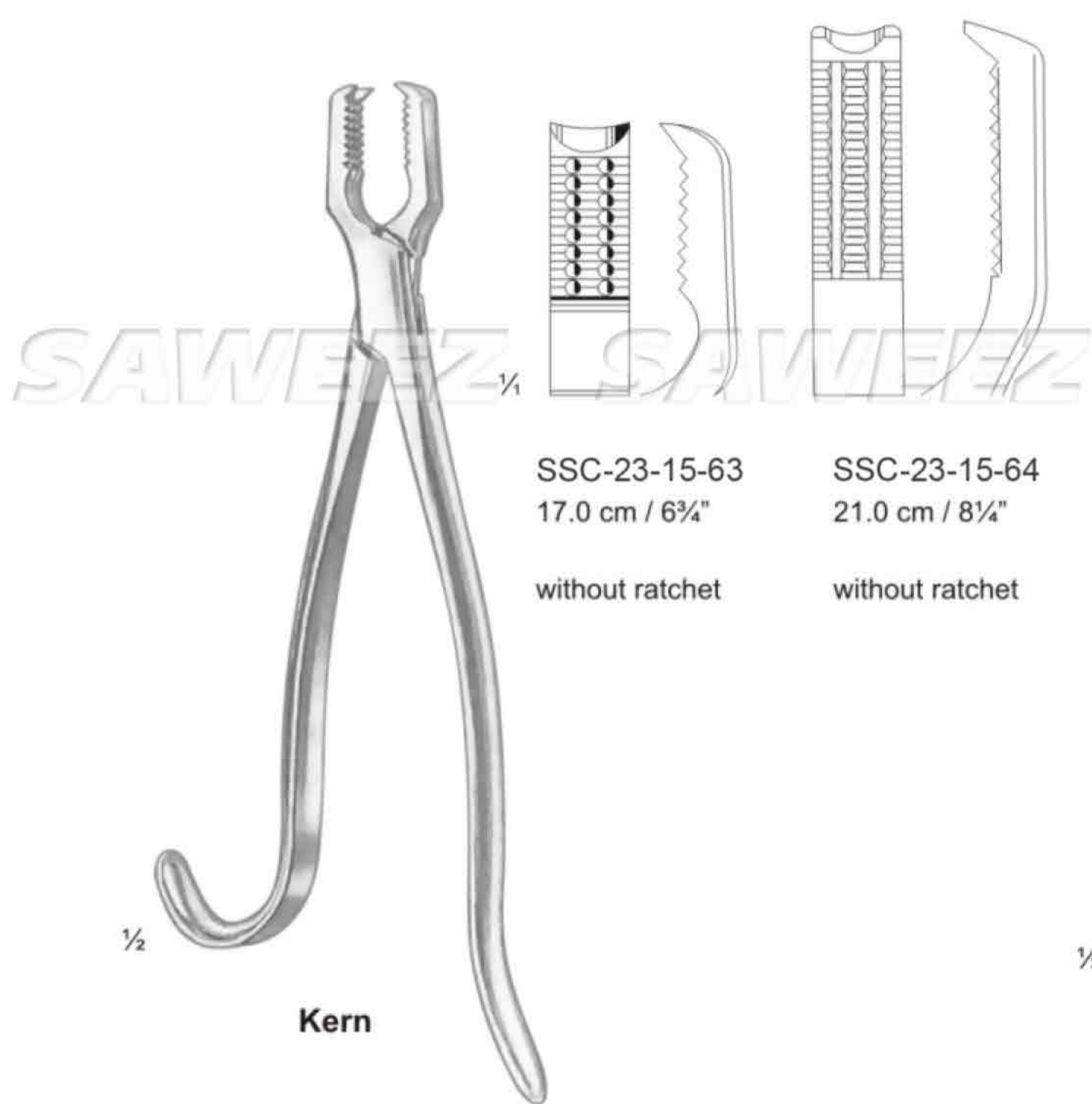
Frosch



SSC-23-15-61
18.0 cm / 7"

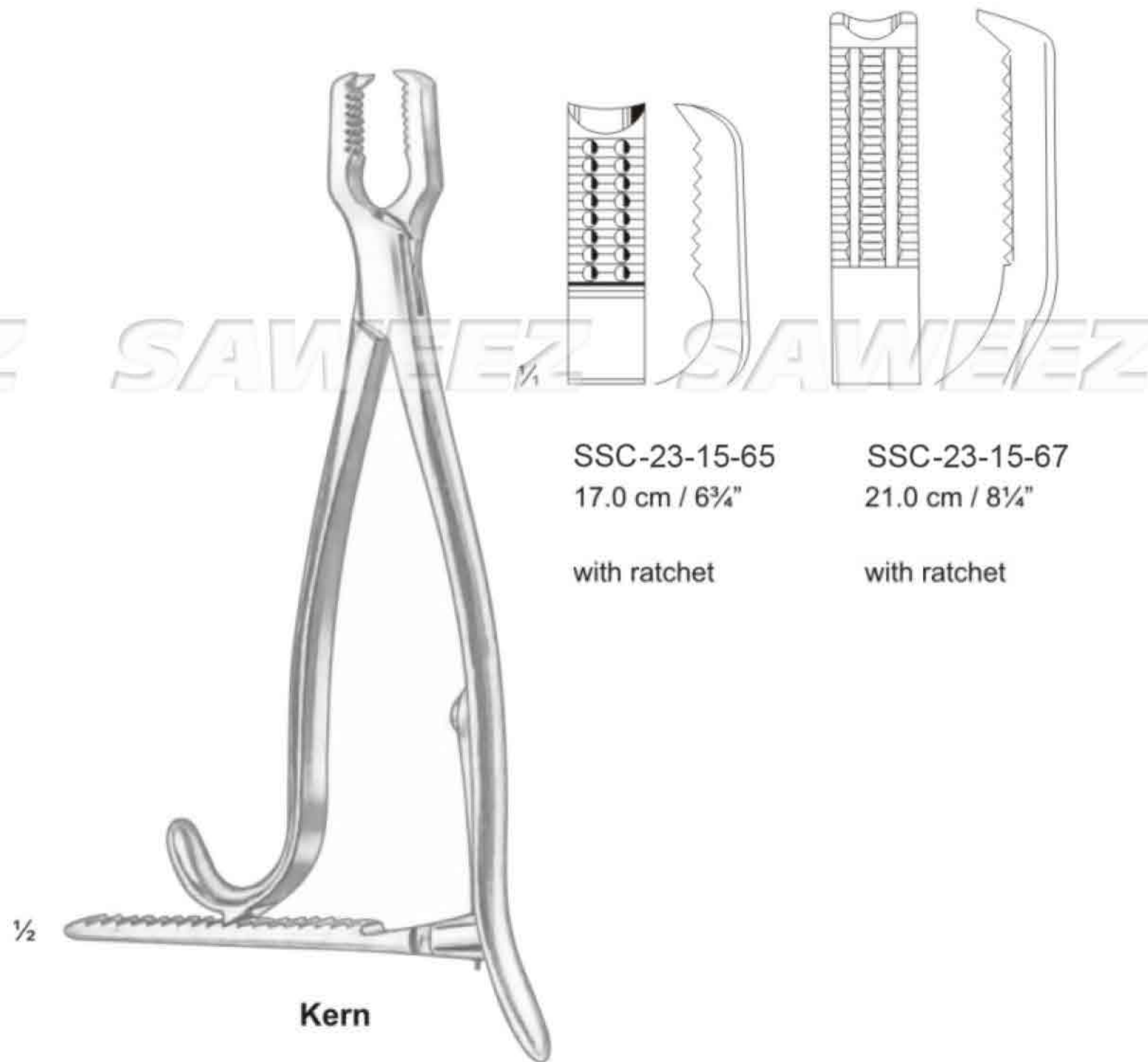


SSC-23-15-62
20.0 cm / 8"



SSC-23-15-63
17.0 cm / 6 3/4"
without ratchet

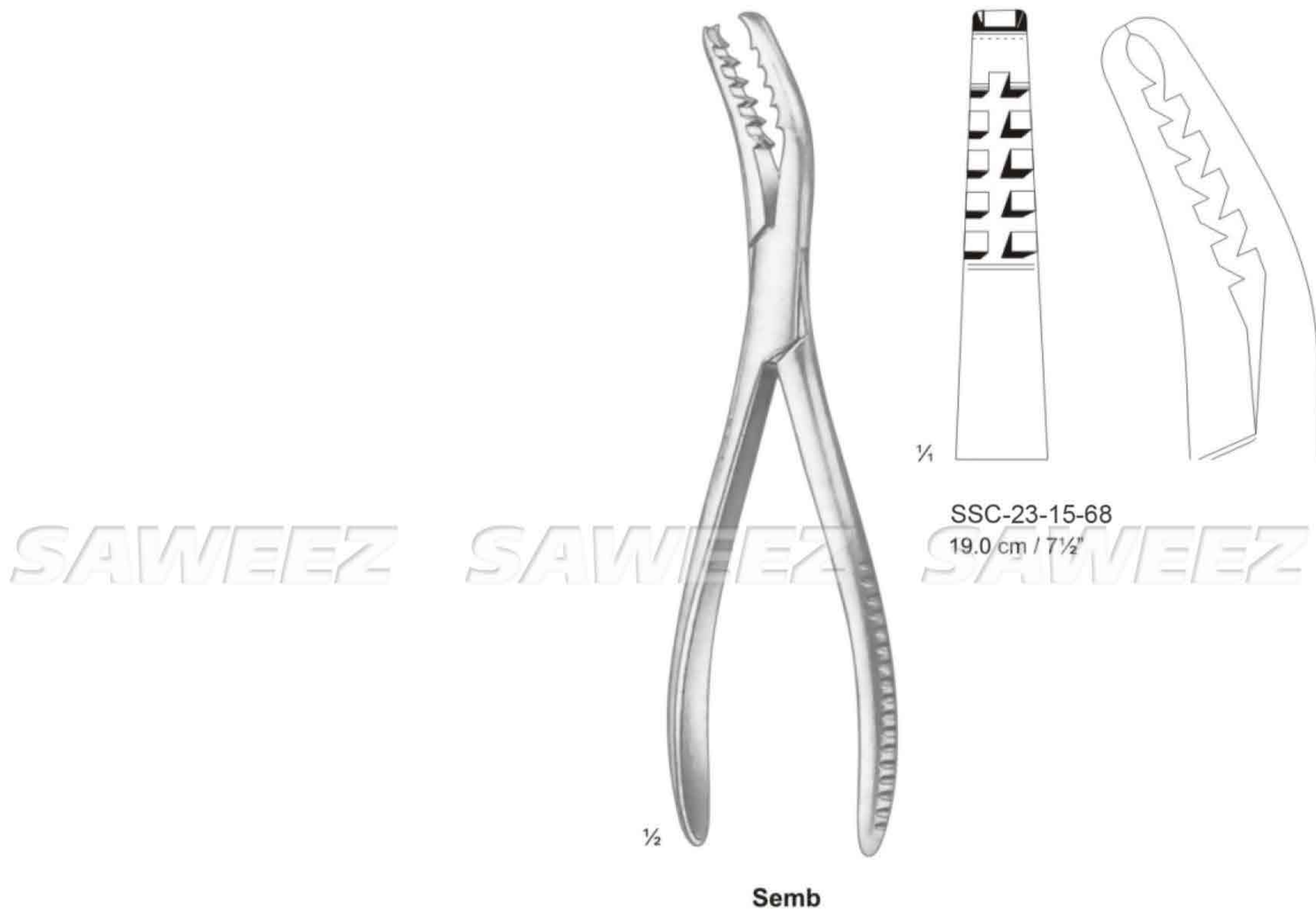
SSC-23-15-64
21.0 cm / 8 1/4"
without ratchet



SSC-23-15-65
17.0 cm / 6 3/4"
with ratchet

SSC-23-15-67
21.0 cm / 8 1/4"
with ratchet

SAWEEZ SAWEEZ SAWEEZ SAWEEZ



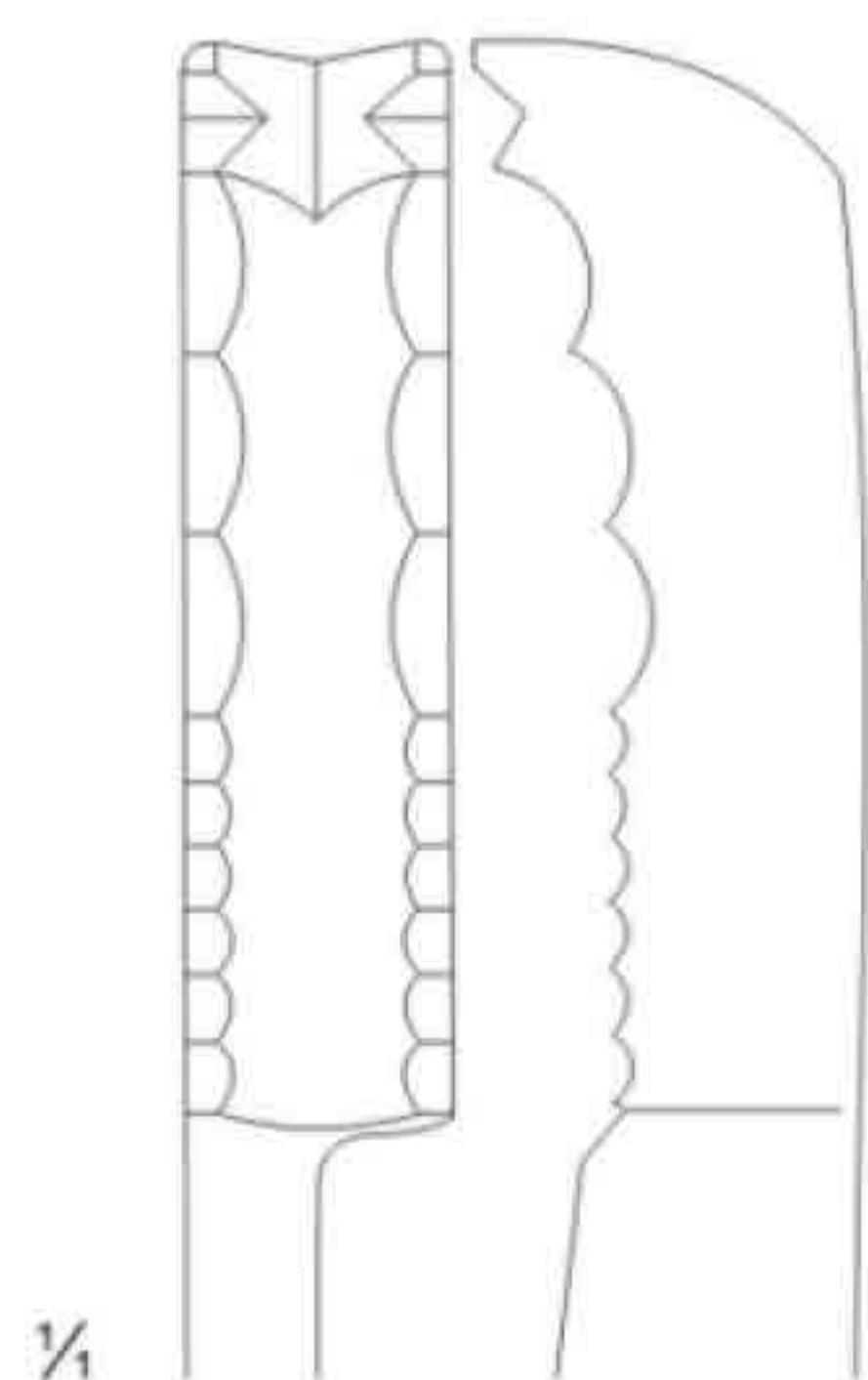
SSC-23-15-68
19.0 cm / 7 1/2"

Semb

SAWEEZ SAWEEZ SAWEEZ SAWEEZ

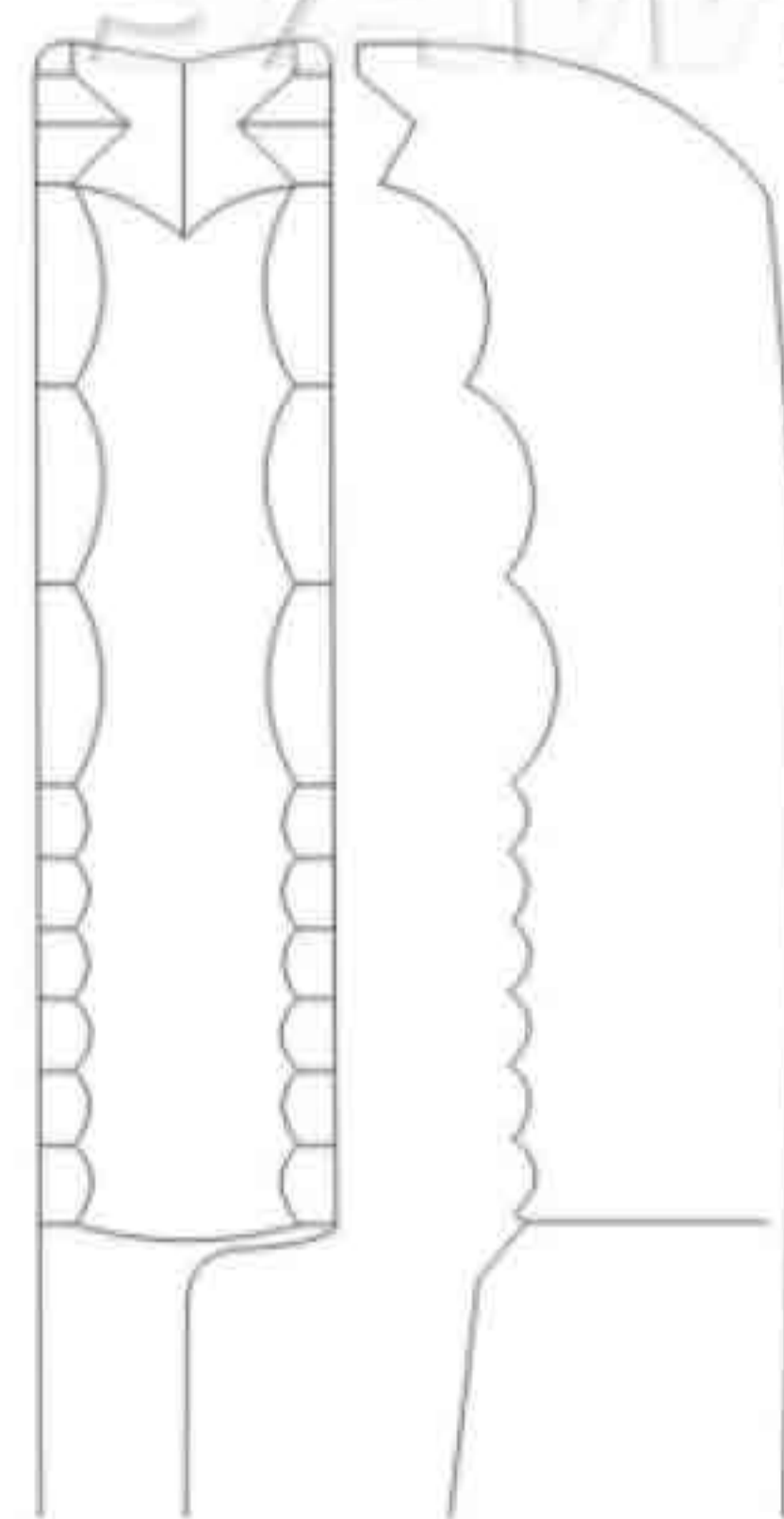


SAWEEZ SAWEEZ SAWEEZ SAWEEZ



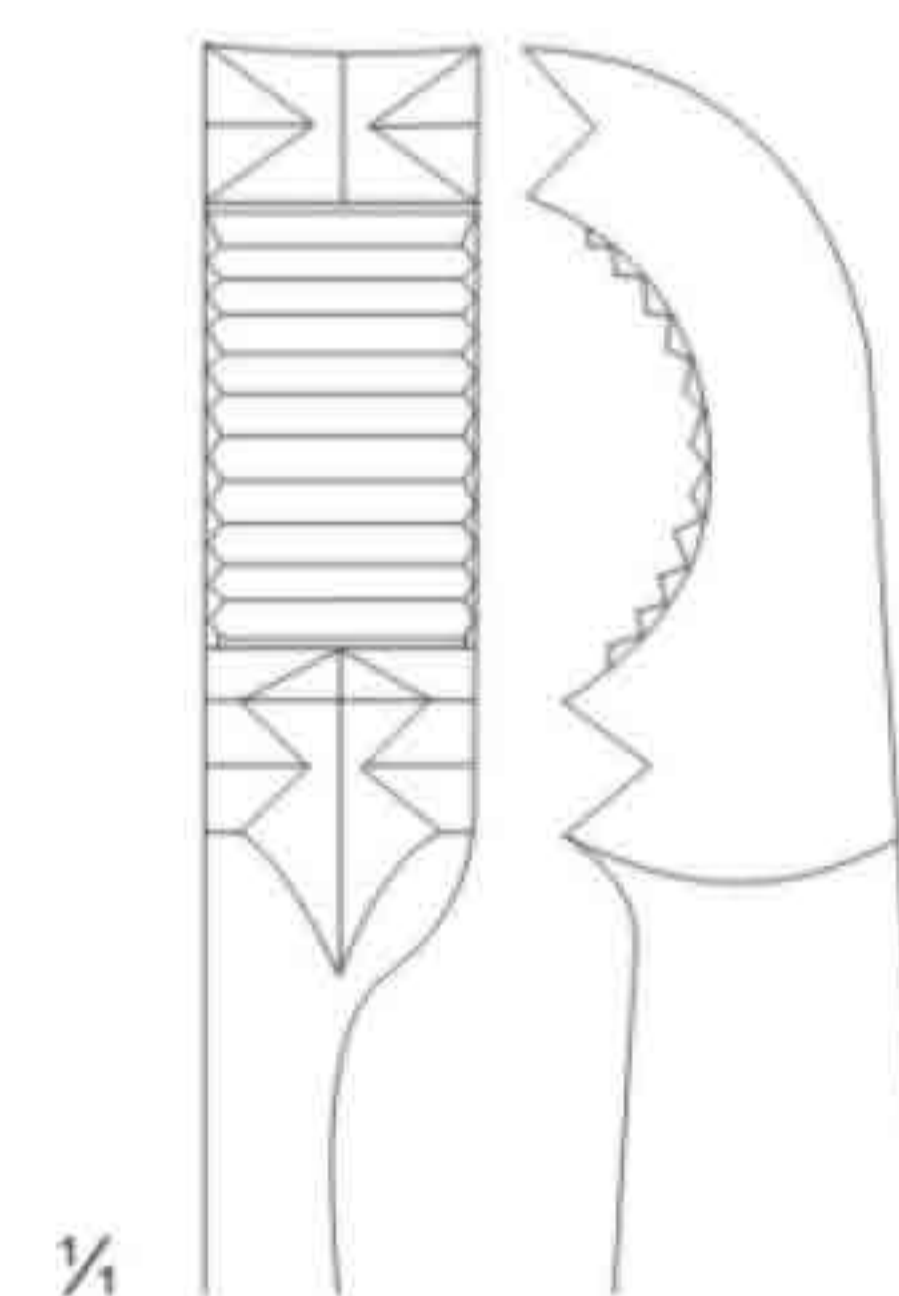
1/4

SSC-23-15-69 - 23.0 cm / 9"
SSC-23-15-70 - 26.0 cm / 10 1/4"



1/4

SSC-23-15-71
26.0 cm / 10 1/4"



1/4

SSC-23-15-72
27.0 cm / 10 1/2"

SAWEEZ SAWEEZ SAWEEZ SAWEEZ



1/2

Farabeuf



1/2

Farabeuf-Lambotte

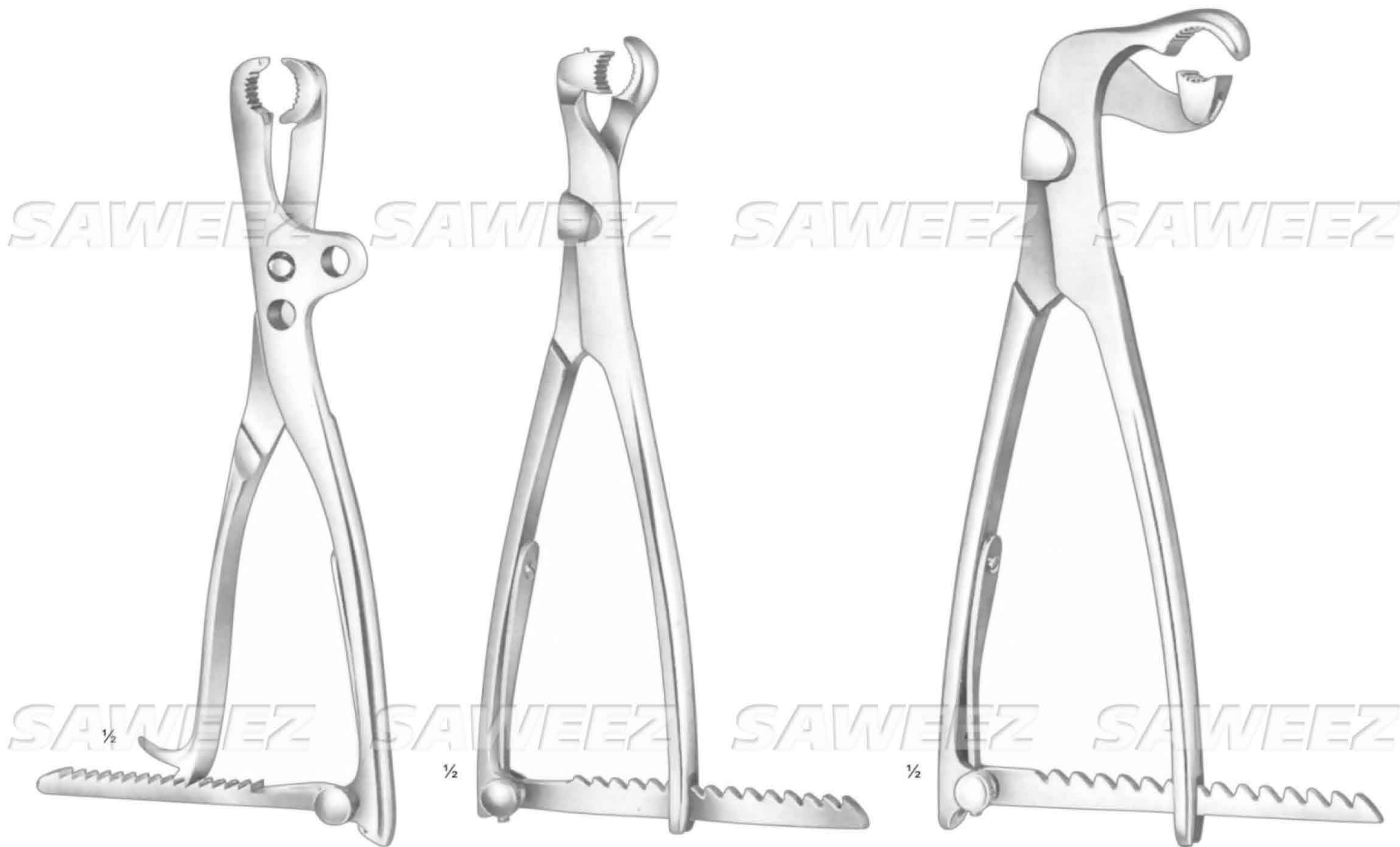
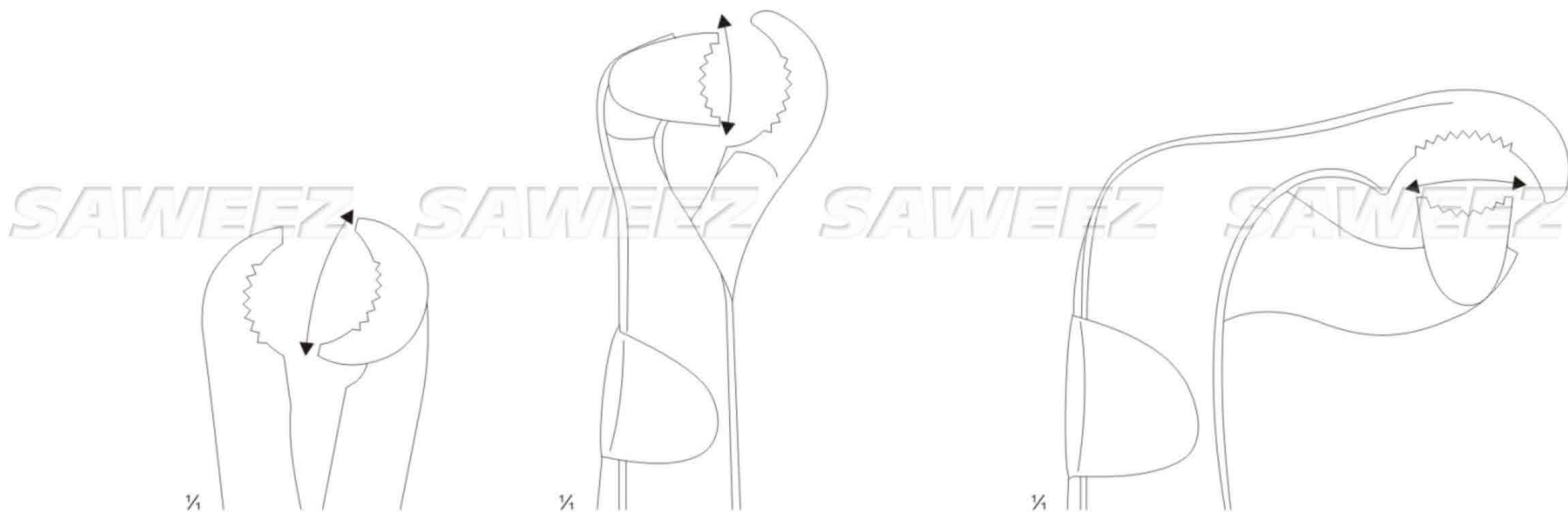


1/2

Tuffire

SAWEEZ SAWEEZ SAWEEZ SAWEEZ

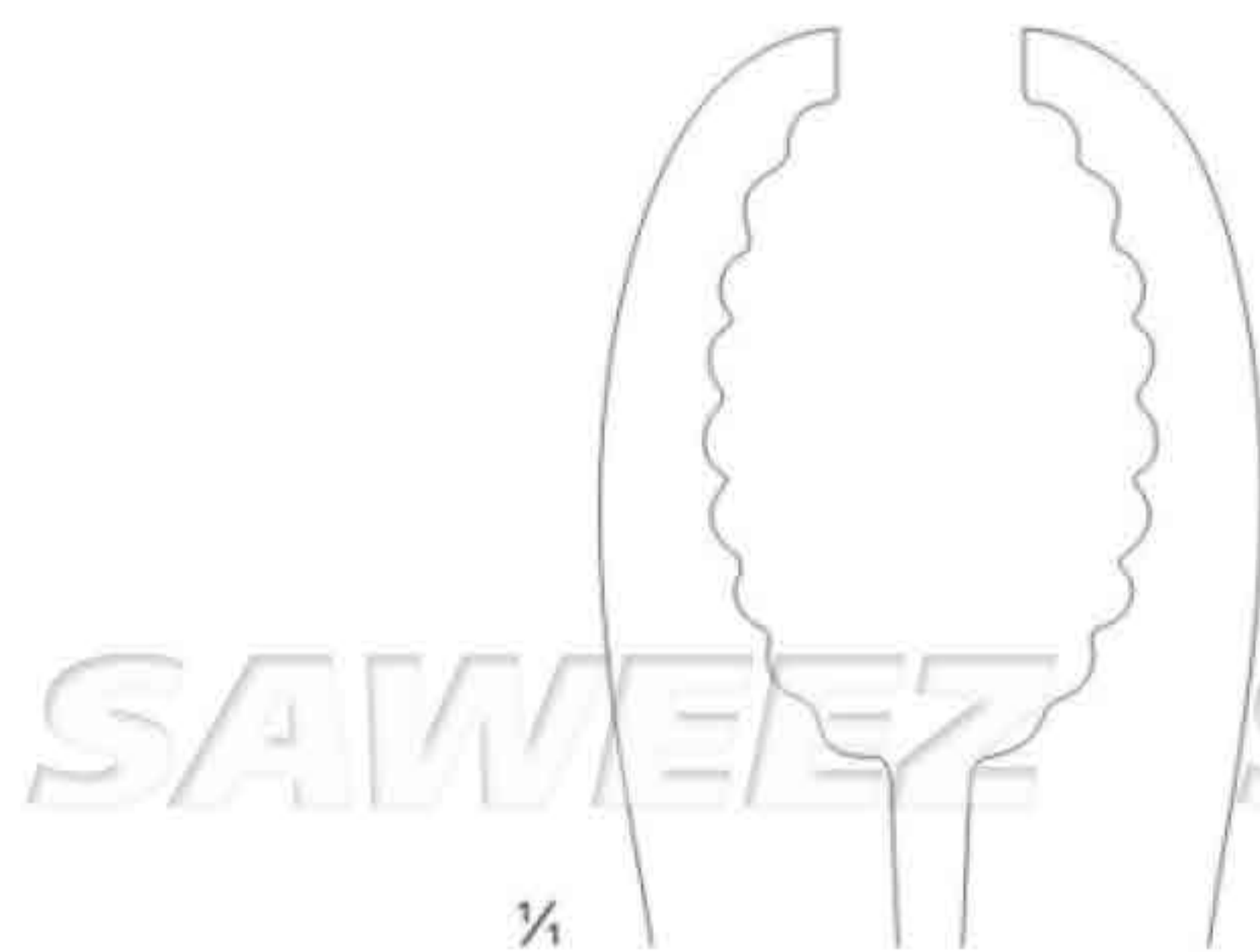
A d i u s t a b l e



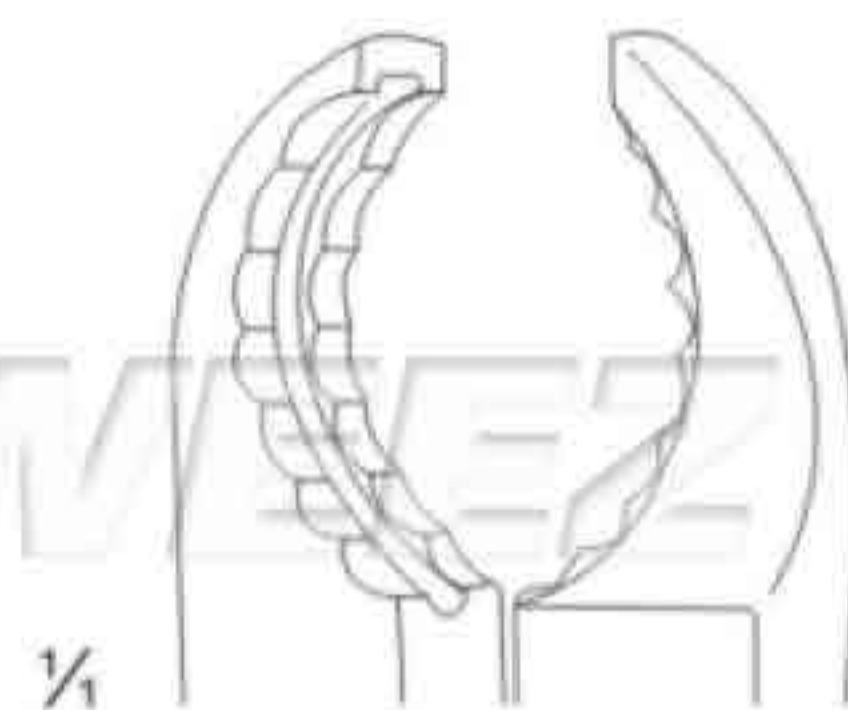
Lambotte
 SSC-23-15-73 - 22.0 cm / 8 3/4"
 SSC-23-15-74 - 27.0 cm / 10"
 SSC-23-15-75 - 30.0 cm / 12"

Lambotte
 SSC-23-15-76 - 22.0 cm / 8 3/4"
 SSC-23-15-77 - 26.0 cm / 10 1/4"
 SSC-23-15-78 - 33.0 cm / 13"

Lambotte
 SSC-23-15-79 - 19.0 cm / 7 1/2"
 SSC-23-15-80 - 23.0 cm / 9"
 SSC-23-15-81 - 26.0 cm / 10 1/4"

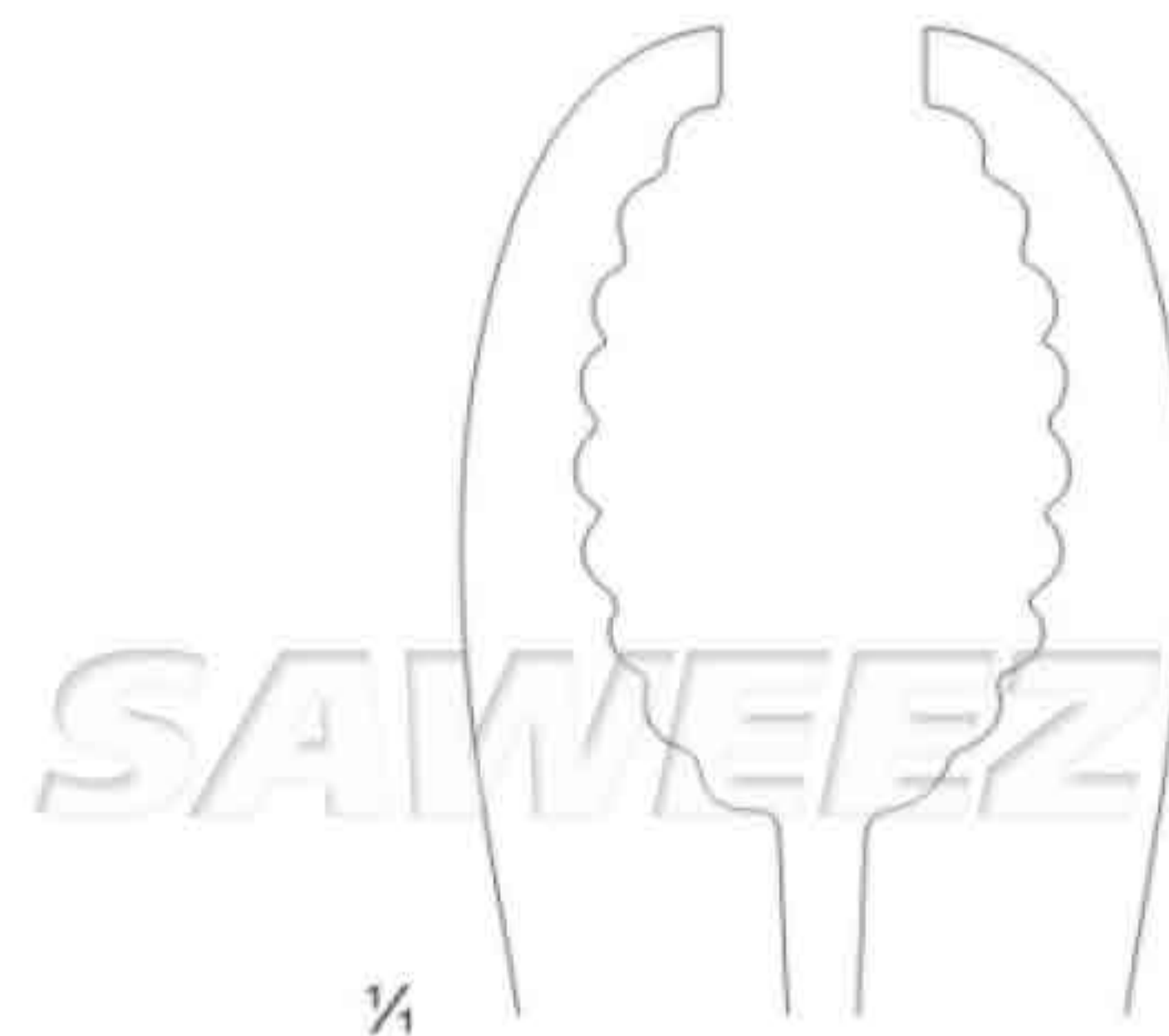


¼

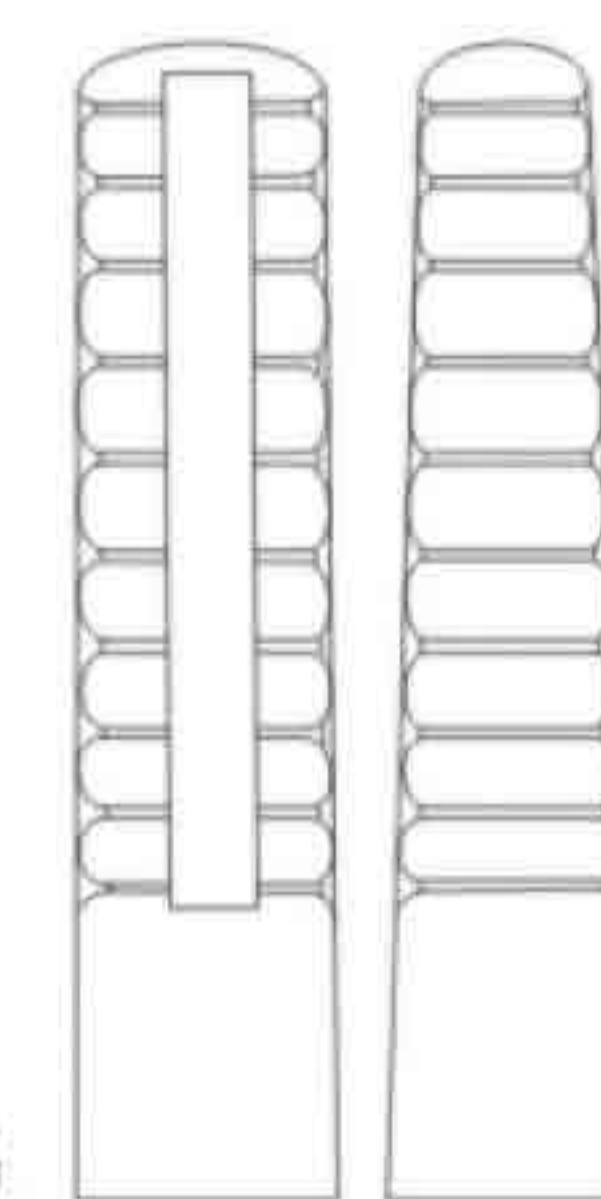


¼

SSC-23-15-82
23.0 cm / 9"

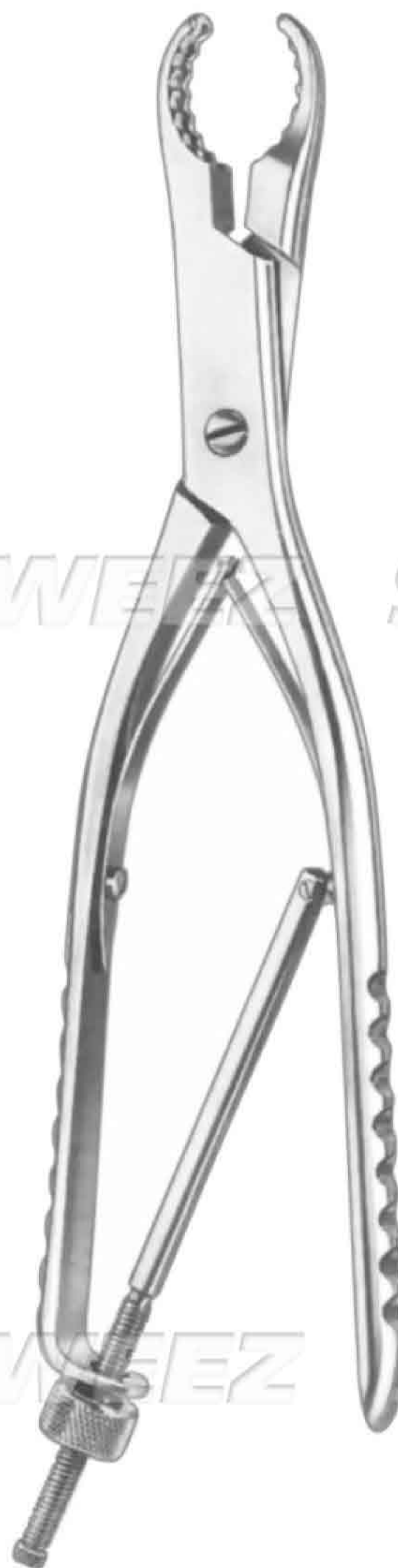


¼

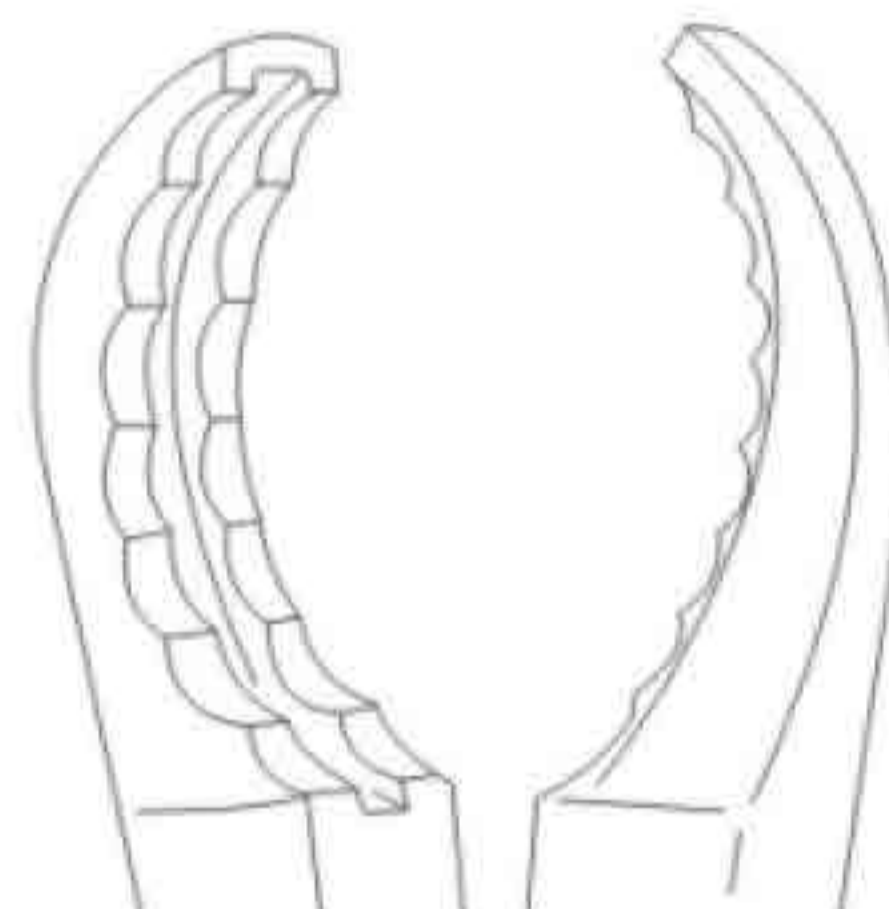


¼

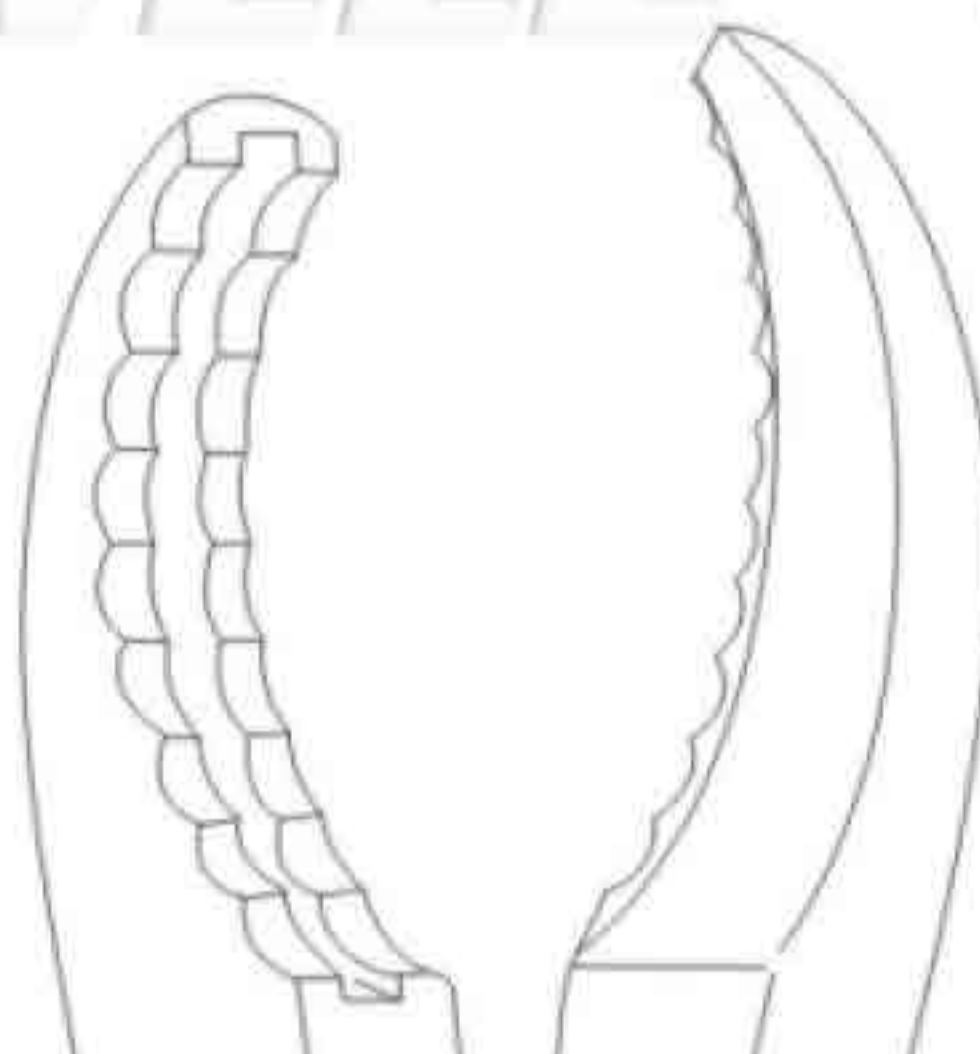
SSC-23-15-85
28.0 cm / 11"



Ulrich



SSC-23-15-83
25.0 cm / 10"

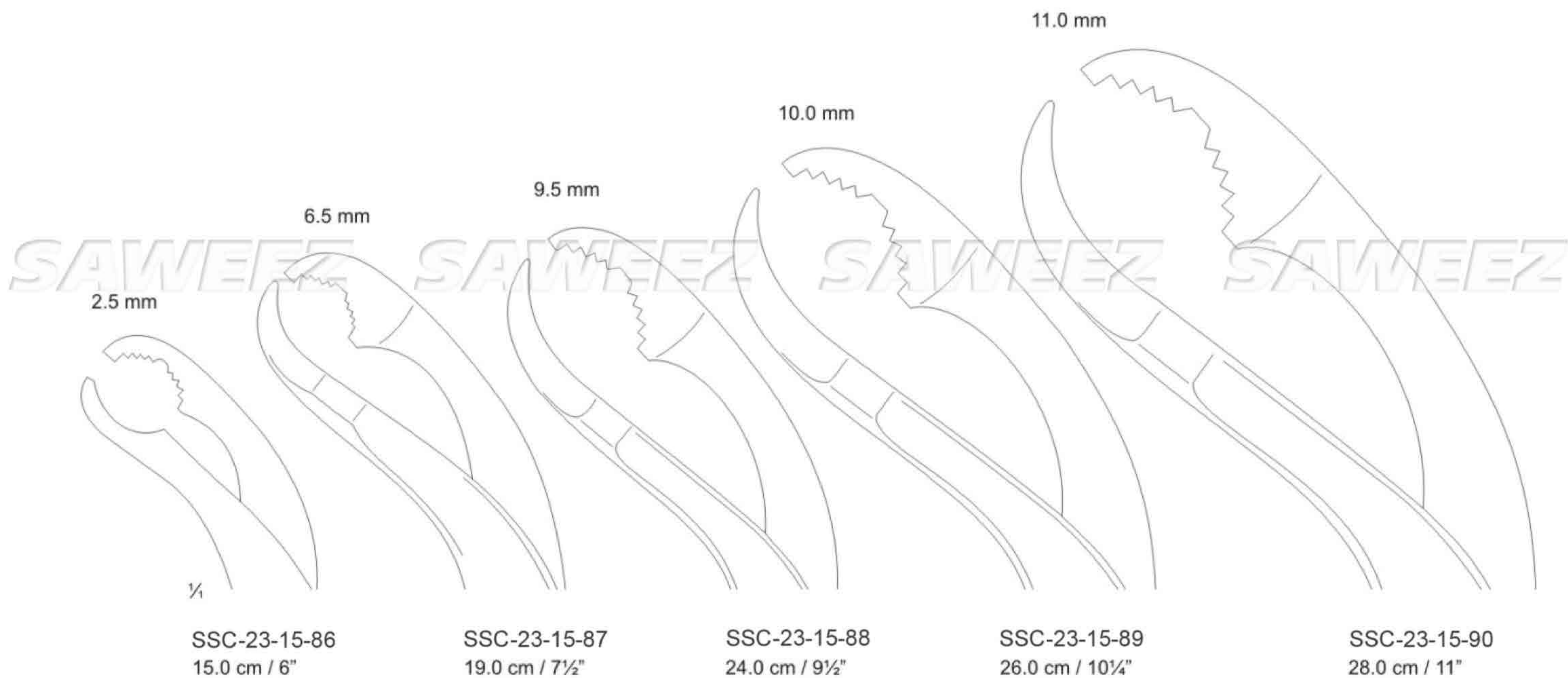


SSC-23-15-84
28.0 cm / 11"



½

Ulrich





SAWEEZ

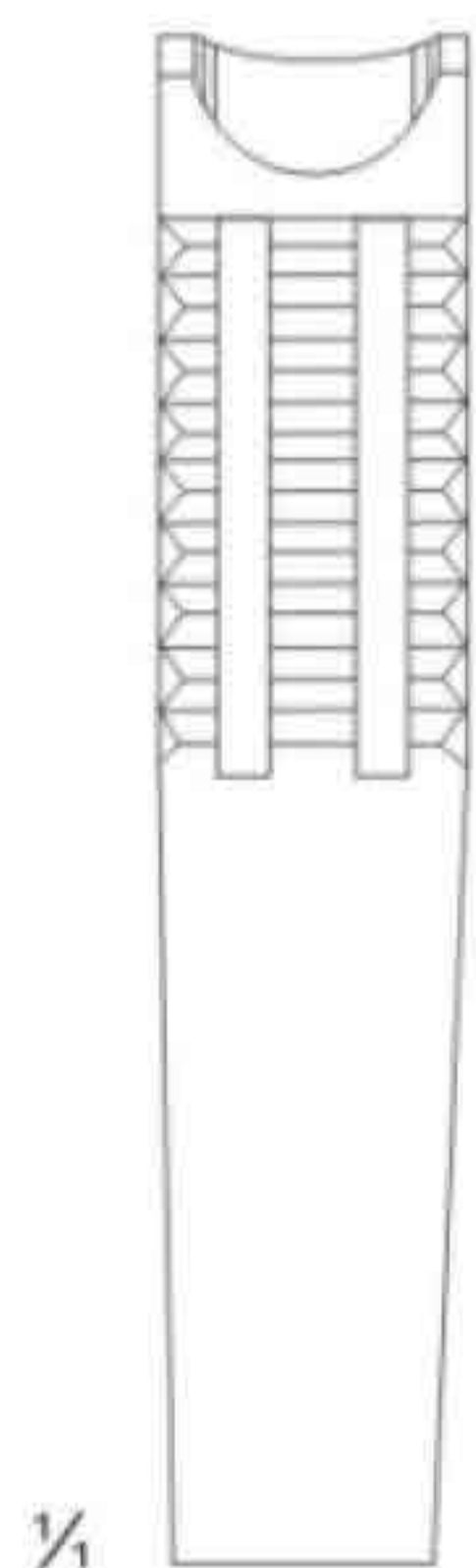
SAWEEZ

SAWEEZ

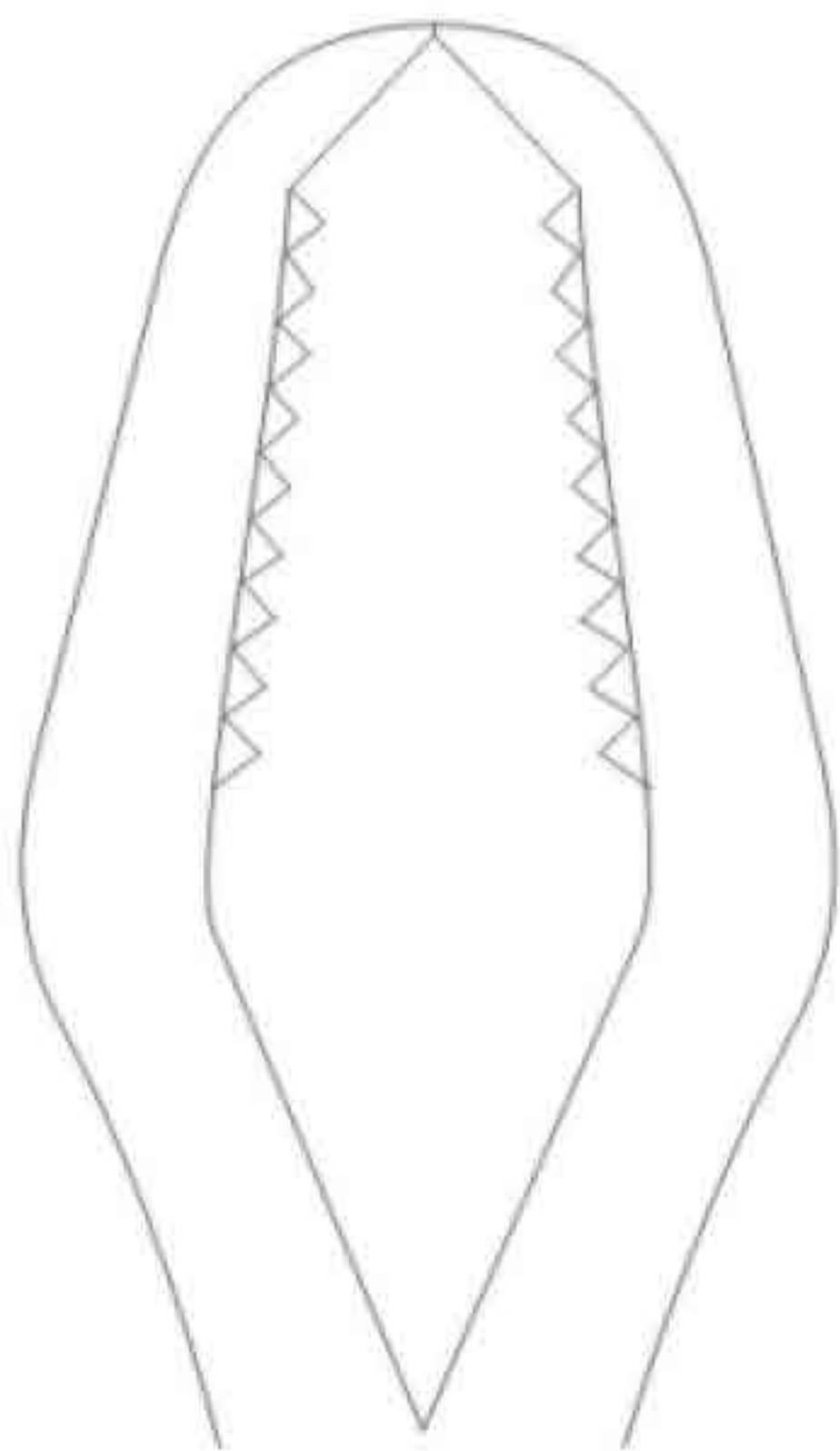
SAWEEZ



Lane



1/4

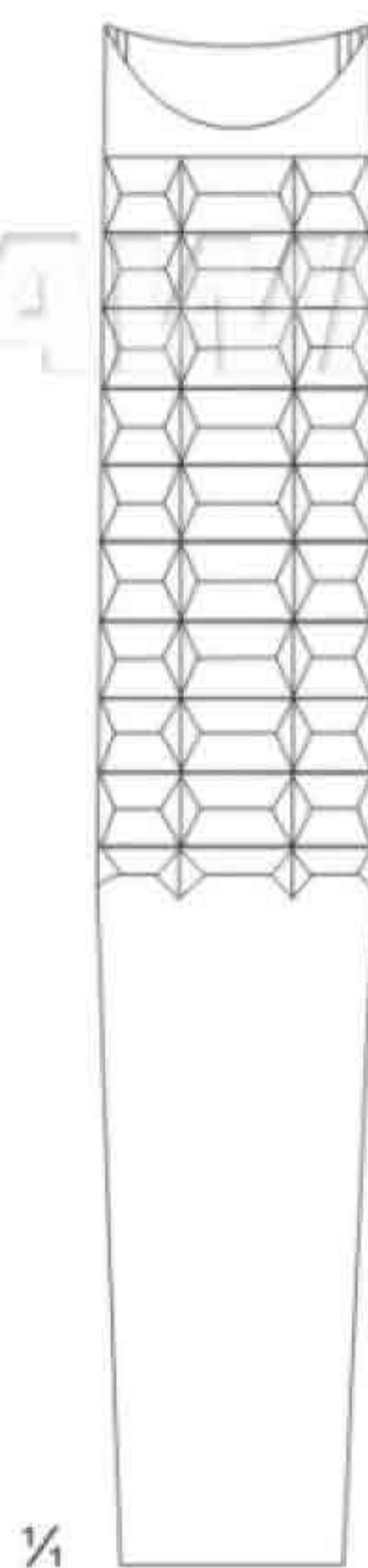


SSC-23-15-91
33.0 cm / 13"

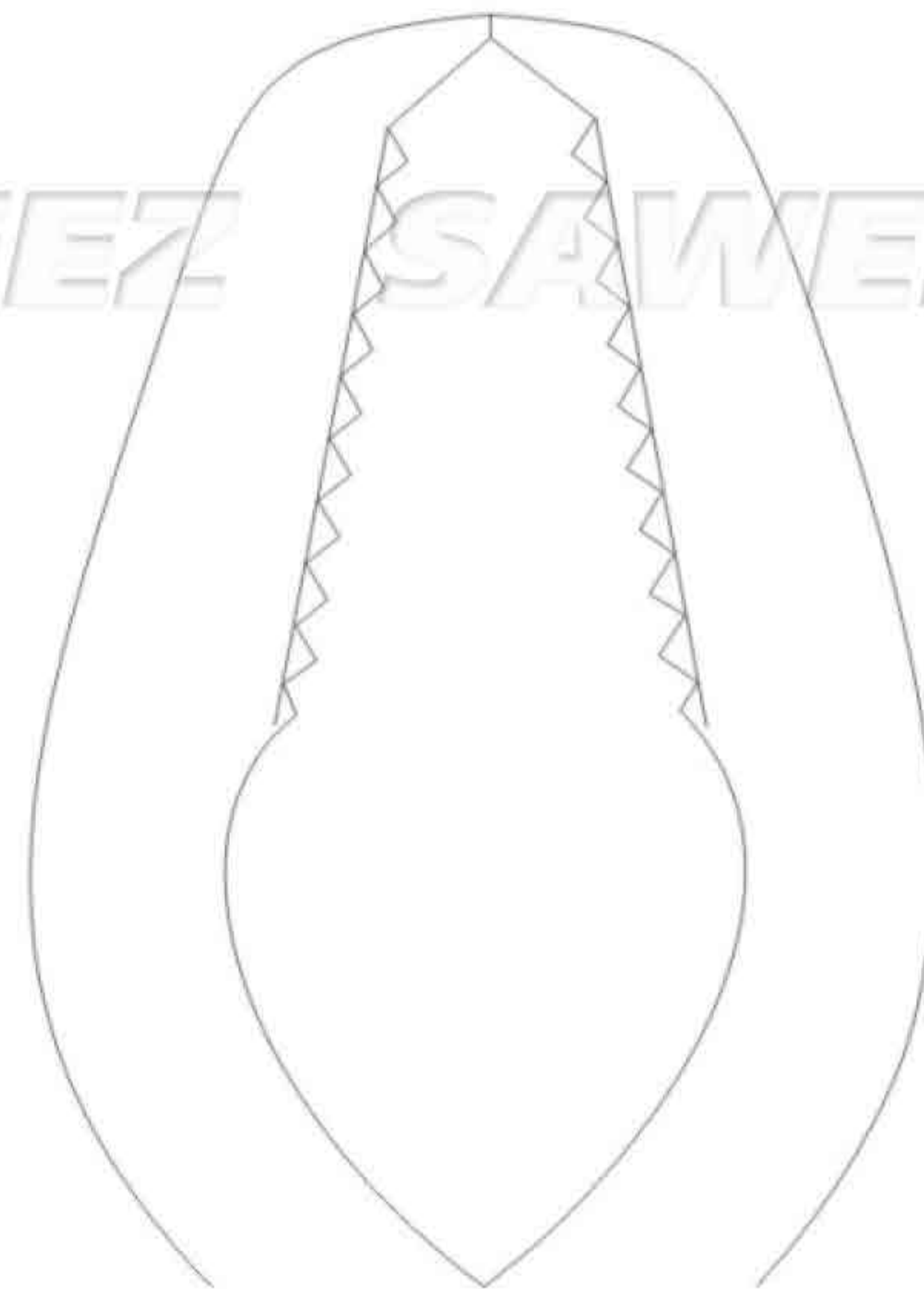
without ratchet

SSC-23-15-92
33.0 cm / 13"

with ratchet



1/4



SSC-23-15-93
45.0 cm / 17"

without ratchet

SSC-23-15-94
45.0 cm / 17"

with ratchet

SAWEEZ

SAWEEZ

SAWEEZ

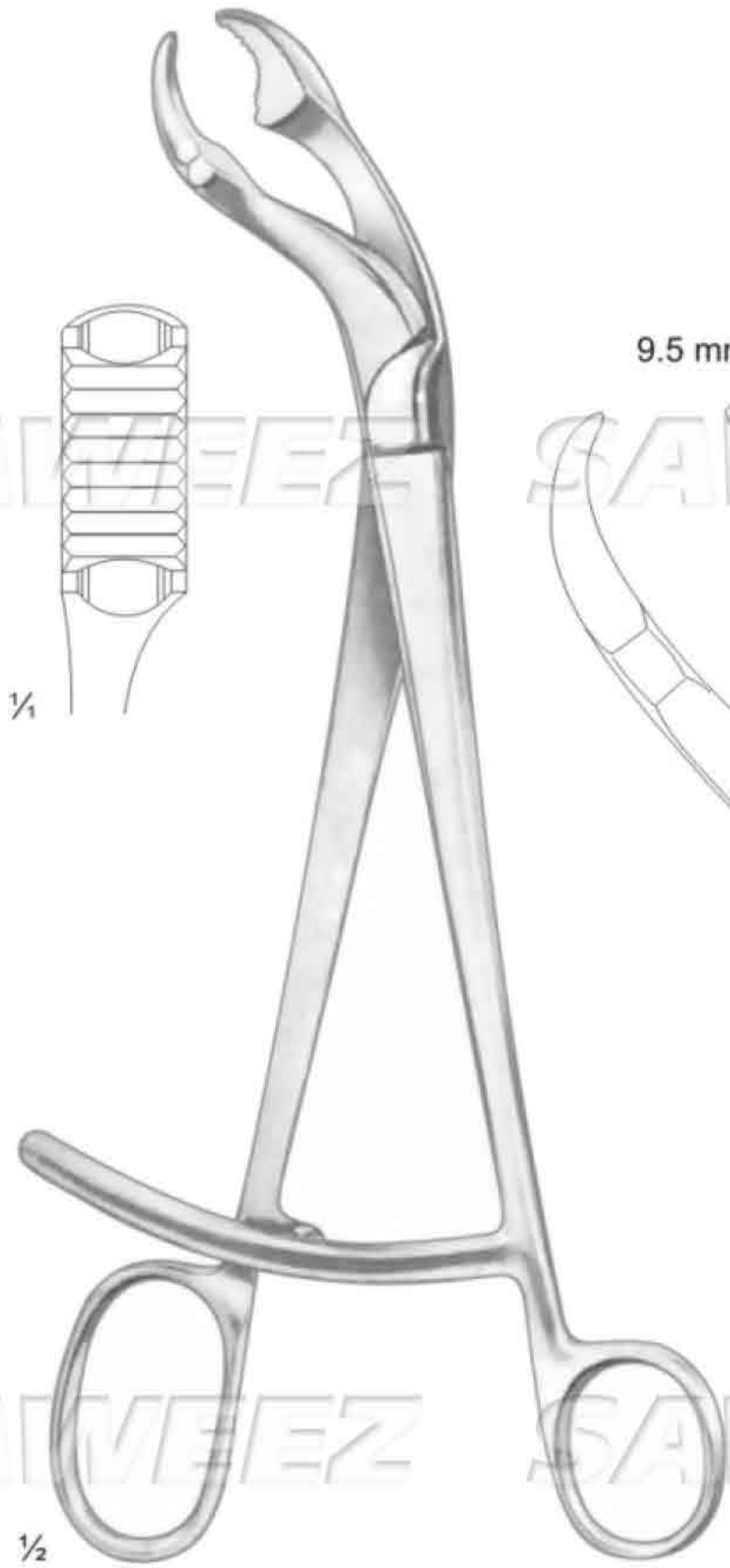
SAWEEZ

SAWEEZ

SAWEEZ

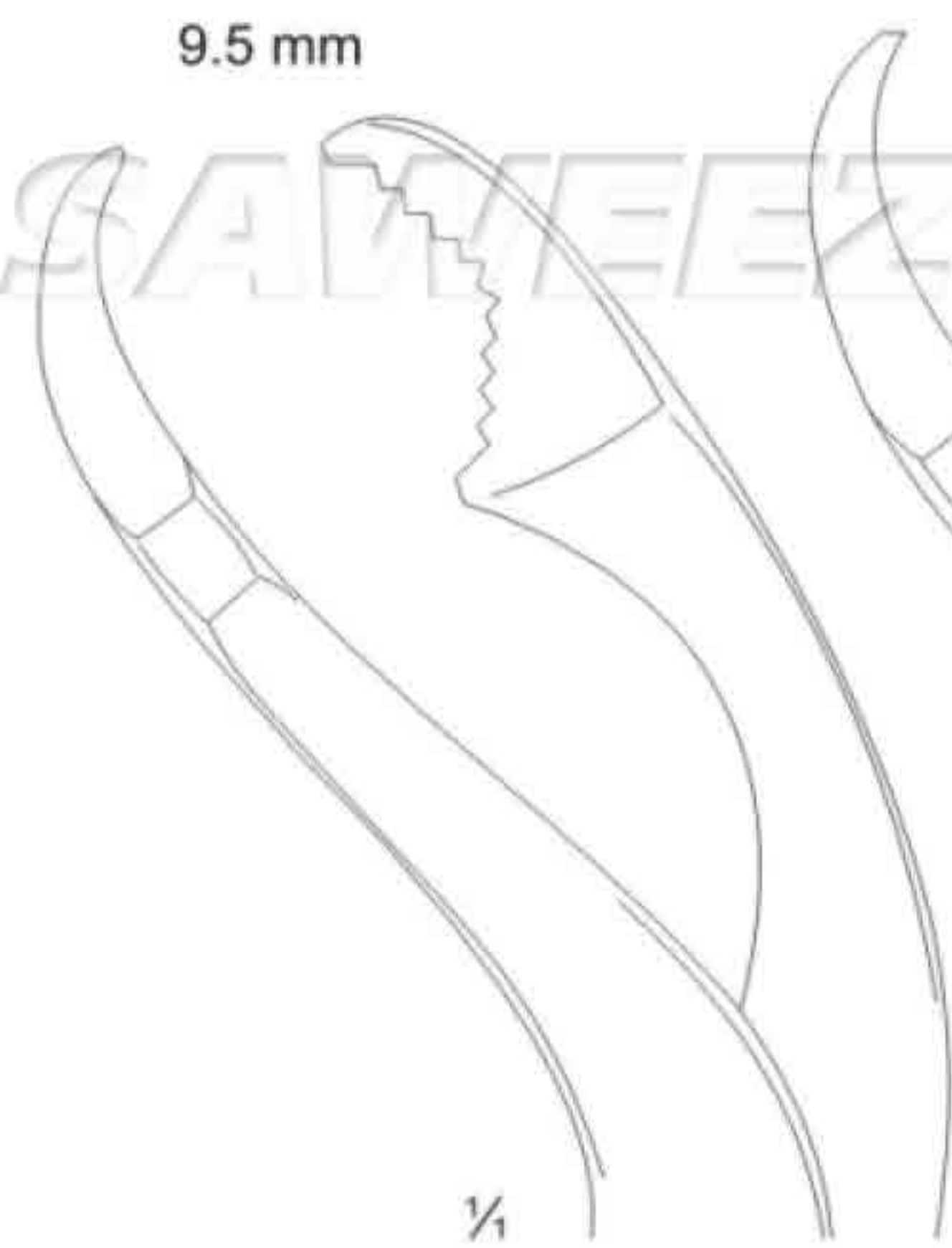
SAWEEZ

SAWEEZ



1/2

Verbrugge



9.5 mm

1/4

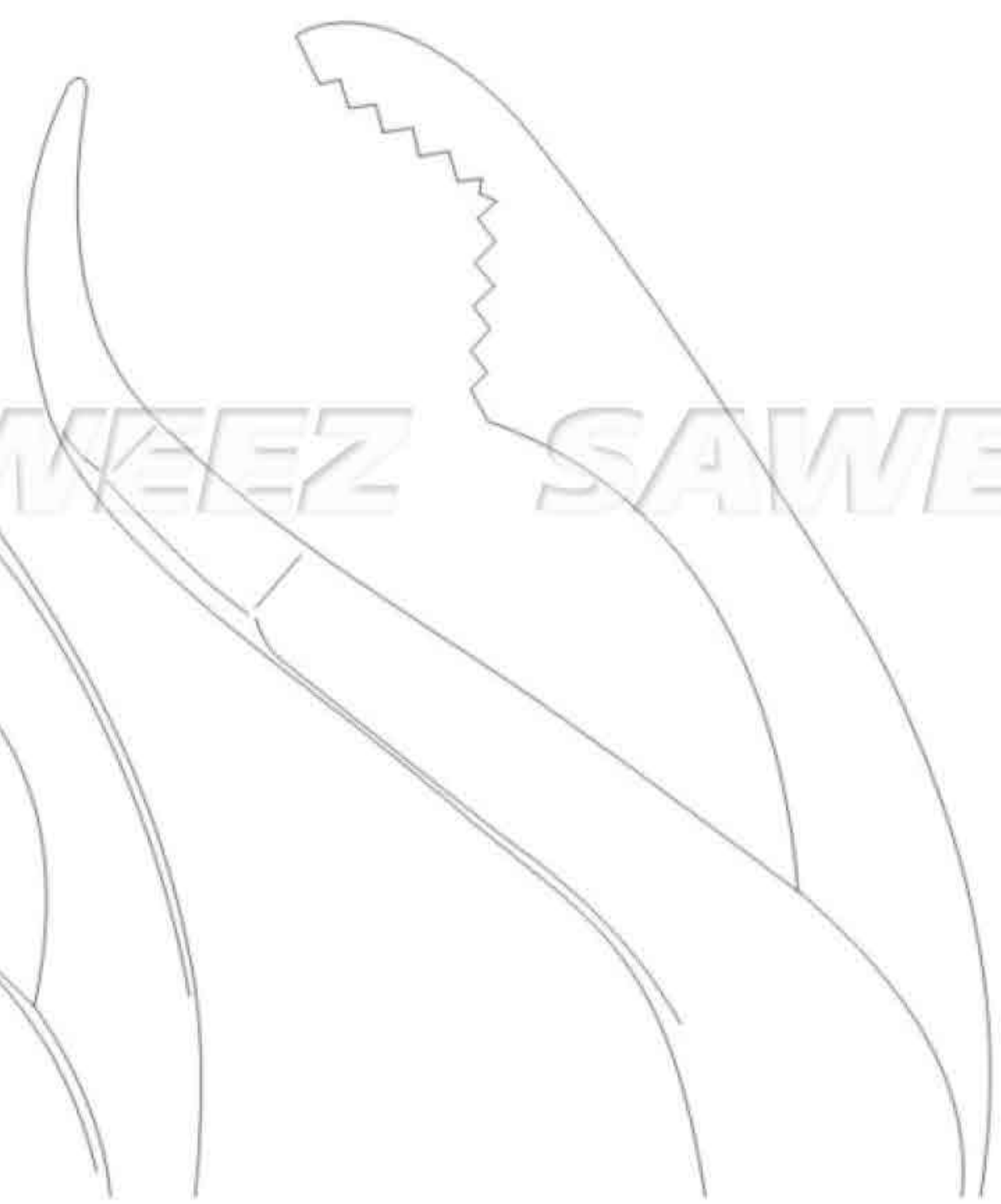
SSC-23-15-95
25.0 cm / 10"



10.5 mm

SSC-23-15-96
26.0 cm / 10 1/4"

12.0 mm



SSC-23-15-97
27.0 cm / 11"

SAWEEZ SAWEEZ SAWEEZ SAWEEZ

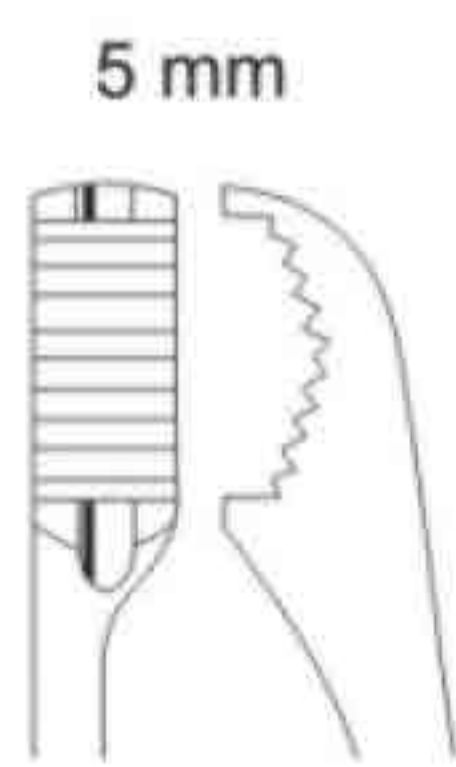


1/4



1/2

Verbrugge



5 mm

1/4

SSC-23-15-98
17.0 cm / 7"

SAWEEZ SAWEEZ SAWEEZ SAWEEZ



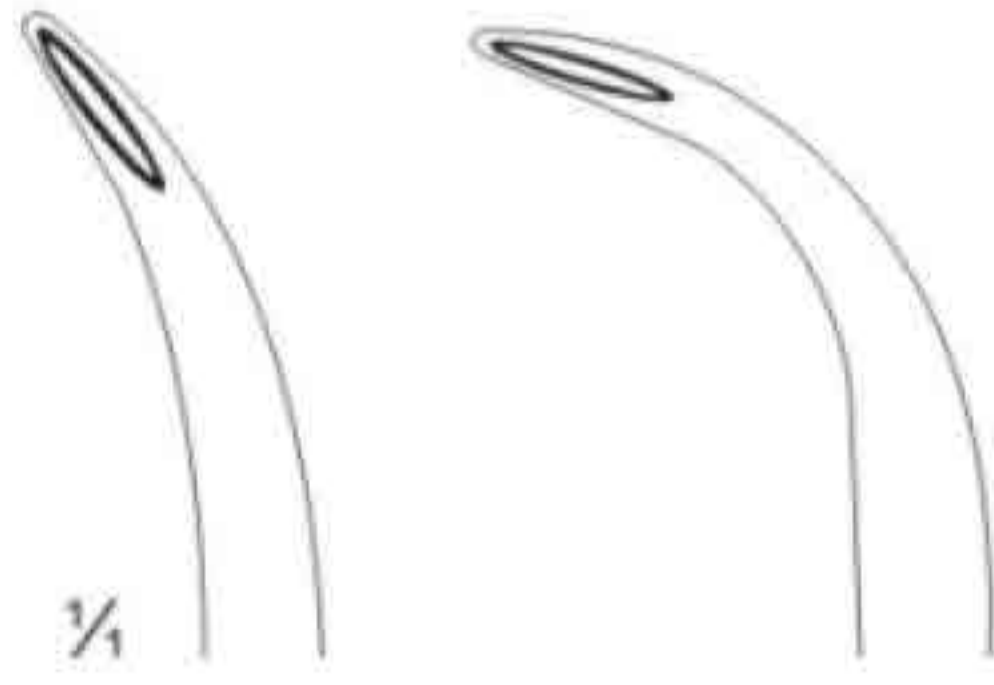
1/3

Amputating Retractor

Percy
SSC-23-15-99



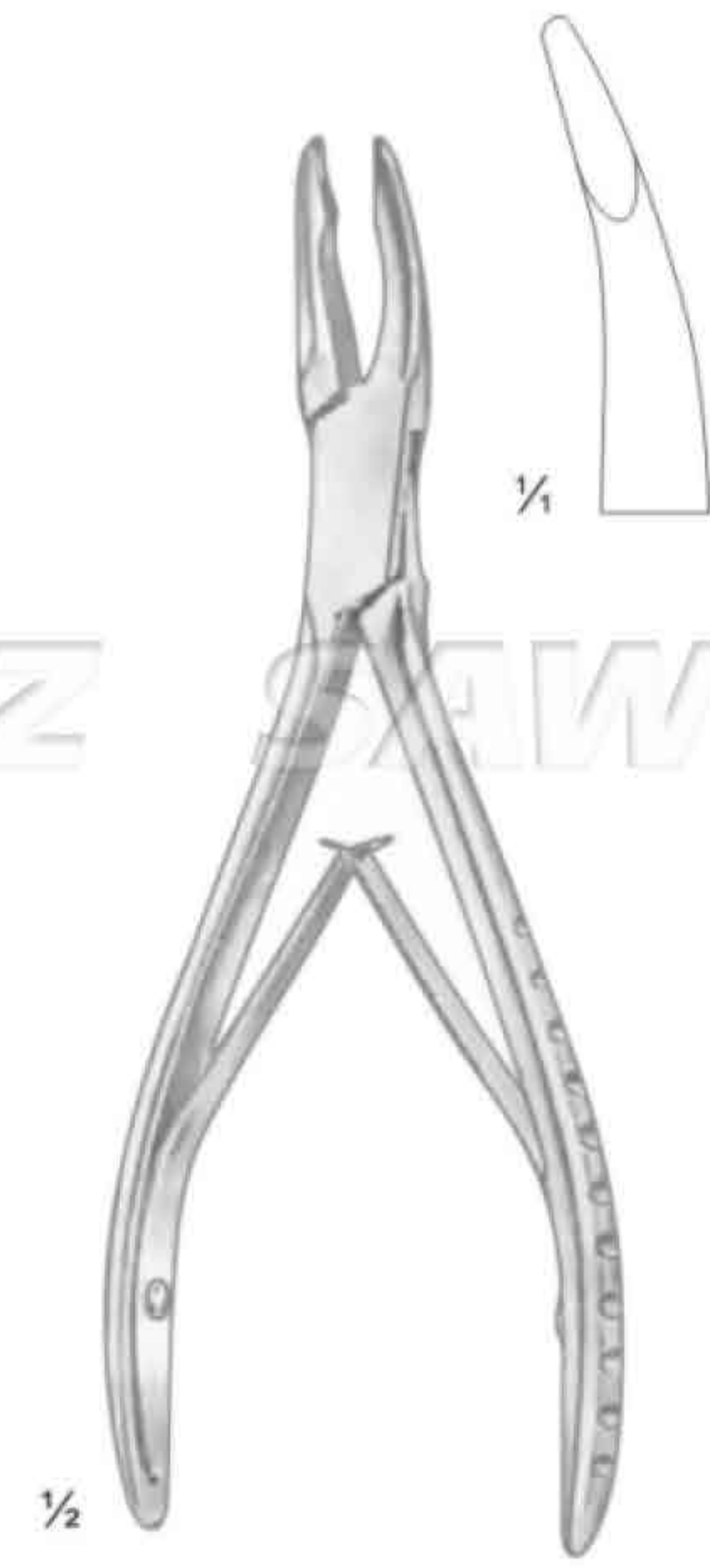
Stellbrink
17.0 cm / 6 3/4"



SSC-23-16-00 2 mm
SSC-23-16-01 2 mm



Mini-Friedman
SSC-23-16-02
13.0 cm / 5"



Friedman
SSC-23-16-03
14.0 cm / 5 1/2"



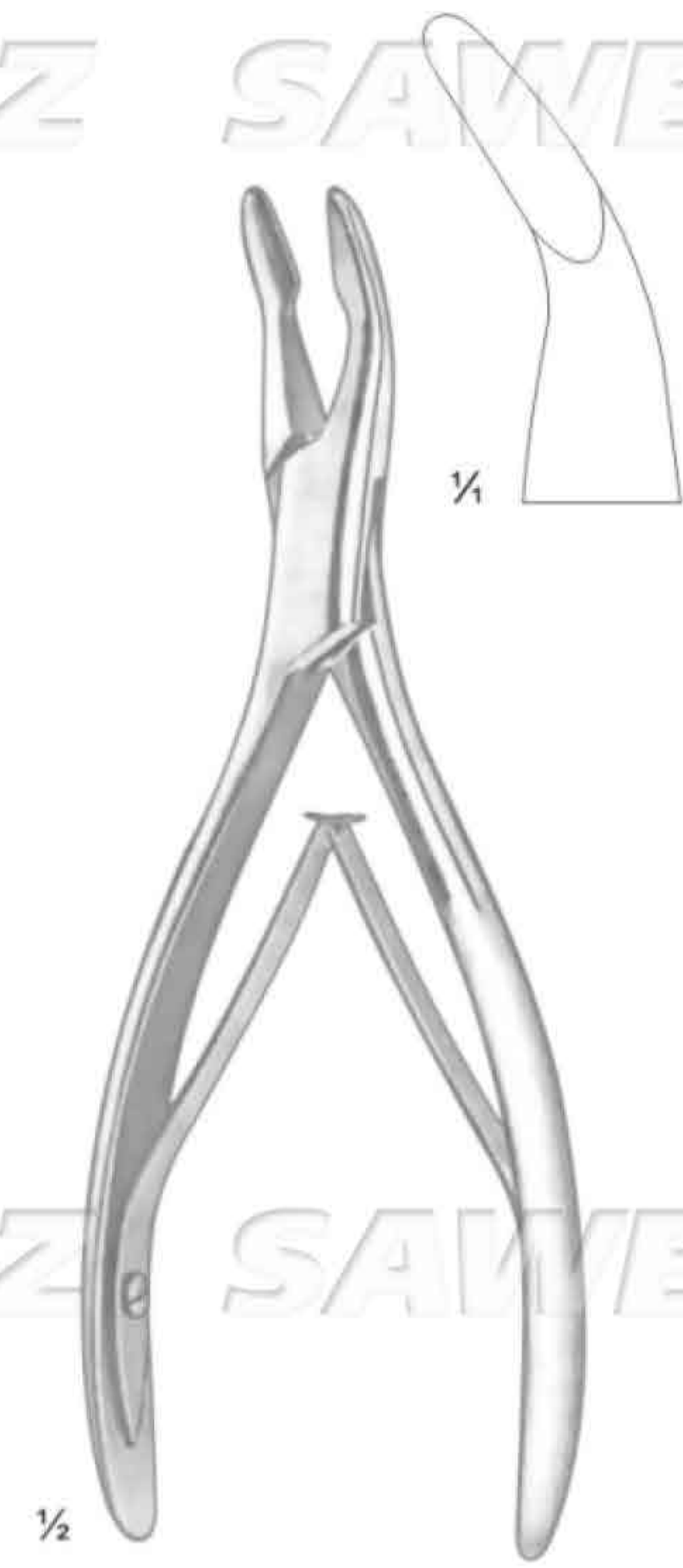
Cleveland
SSC-23-16-04
14.0 cm / 5 1/2"



Cleveland
SSC-23-16-05
17.0 cm / 6 3/4"

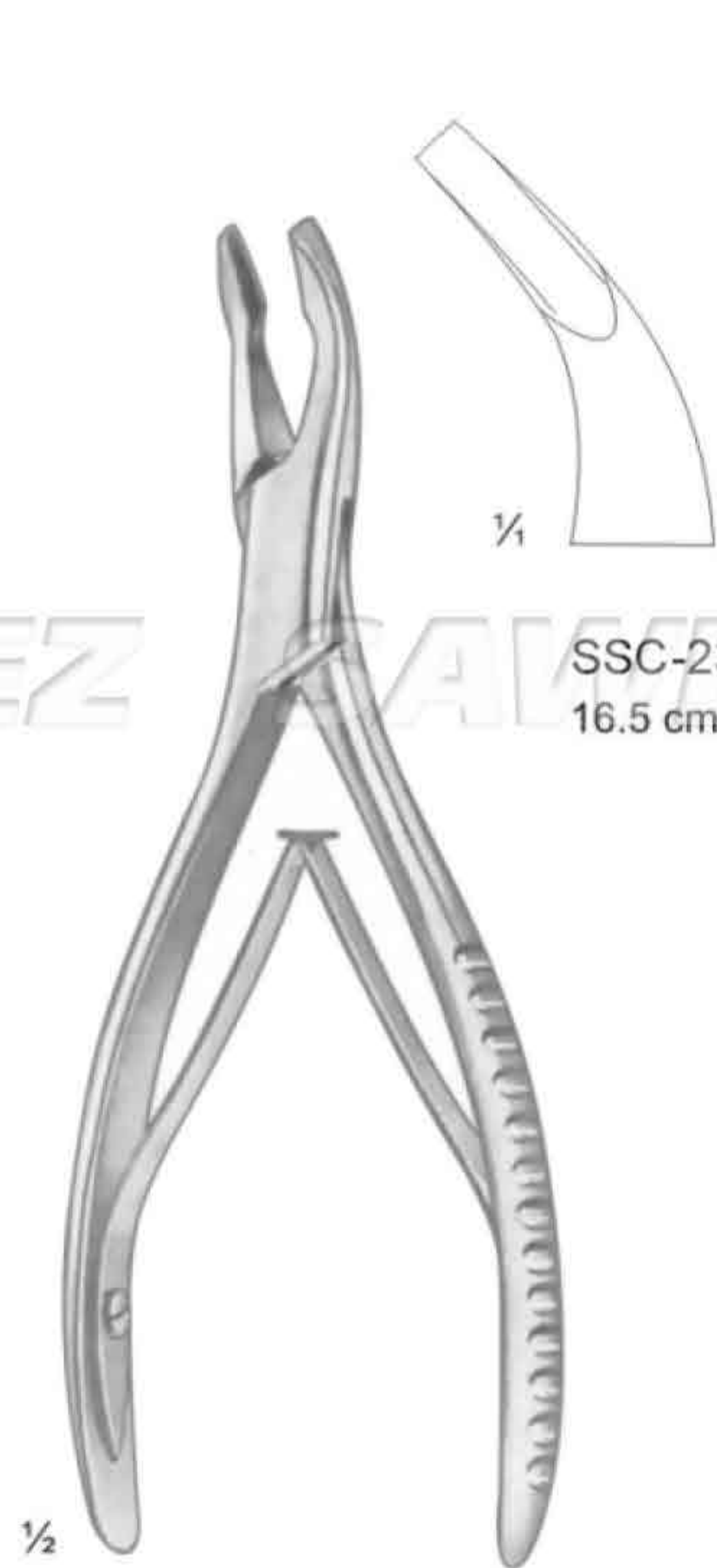


Universal
SSC-23-16-06
13.5 cm / 5 1/4"



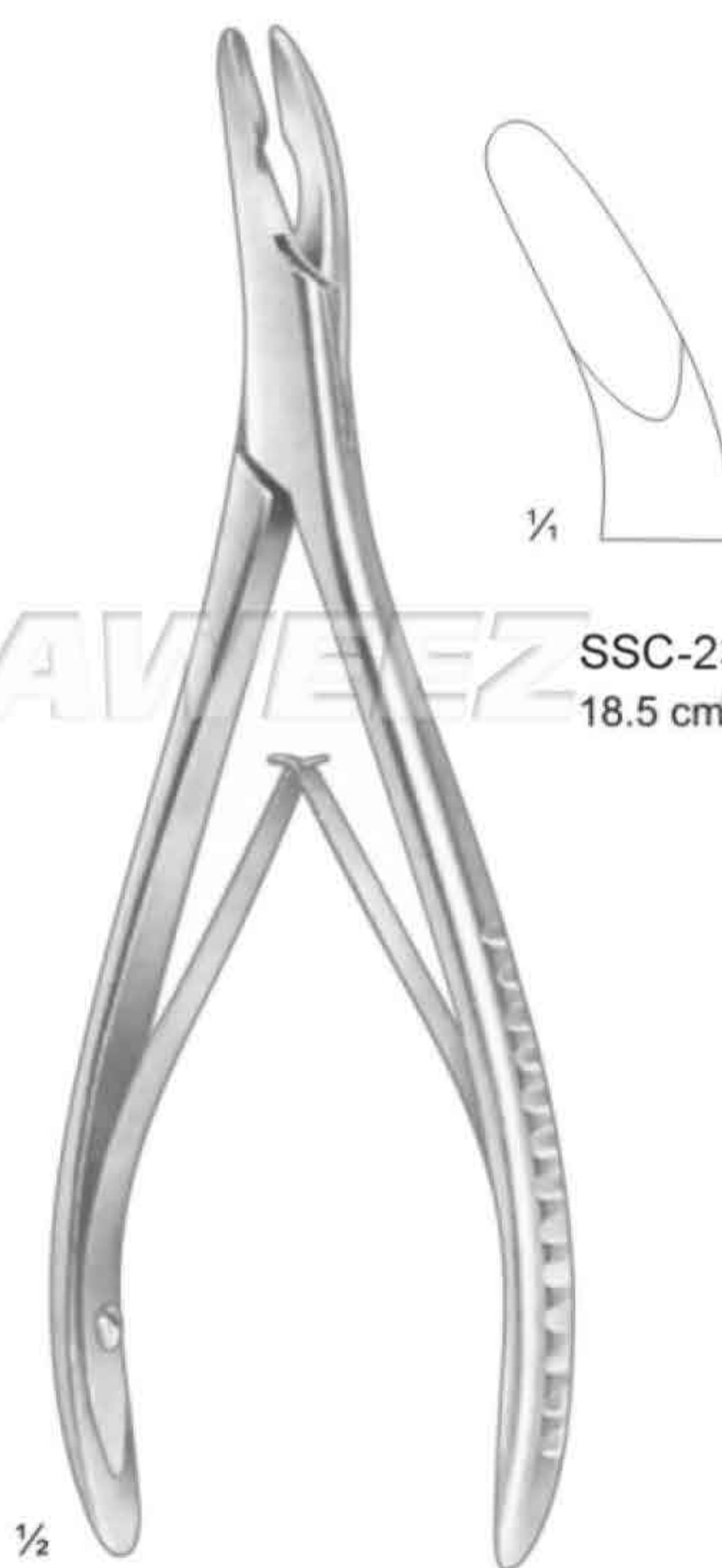
Mead
SSC-23-16-07
16.5 cm / 6 1/2"





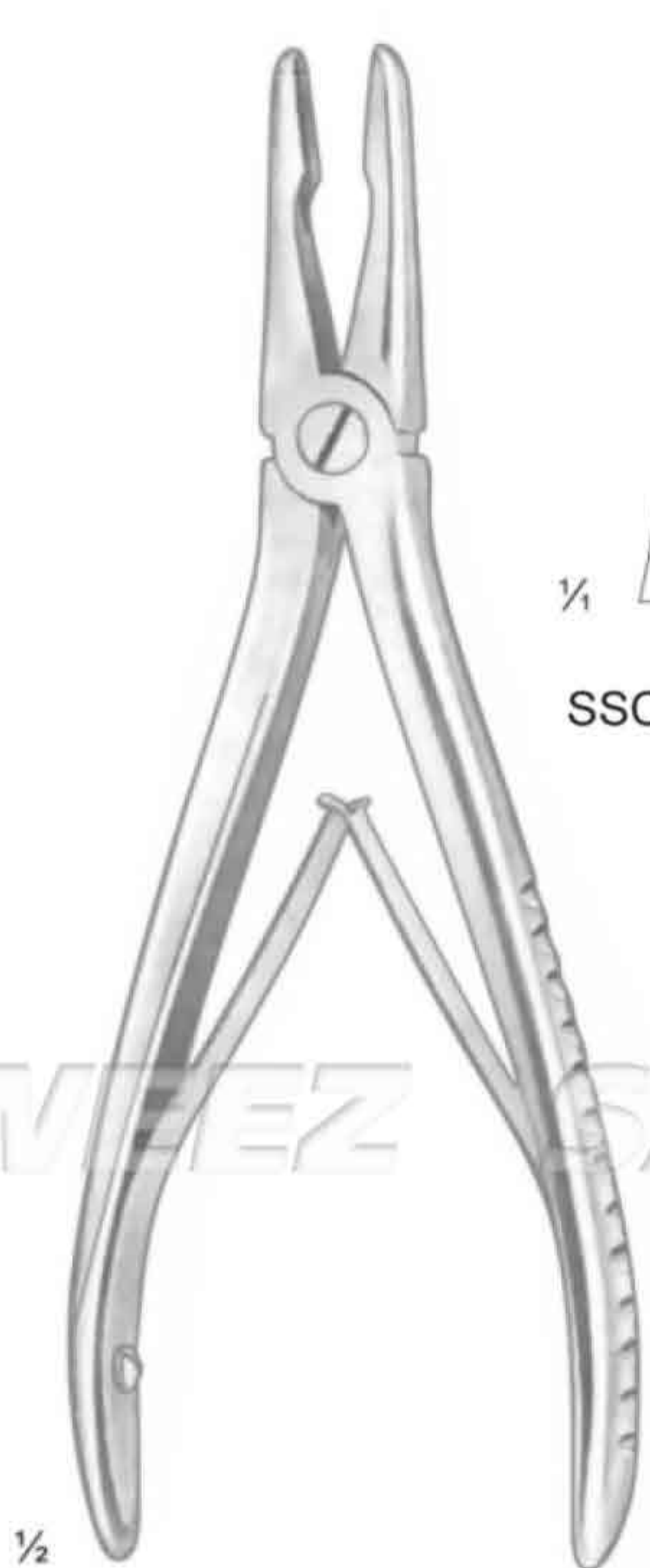
SSC-23-16-08
16.5 cm / 6 1/2"

Mead

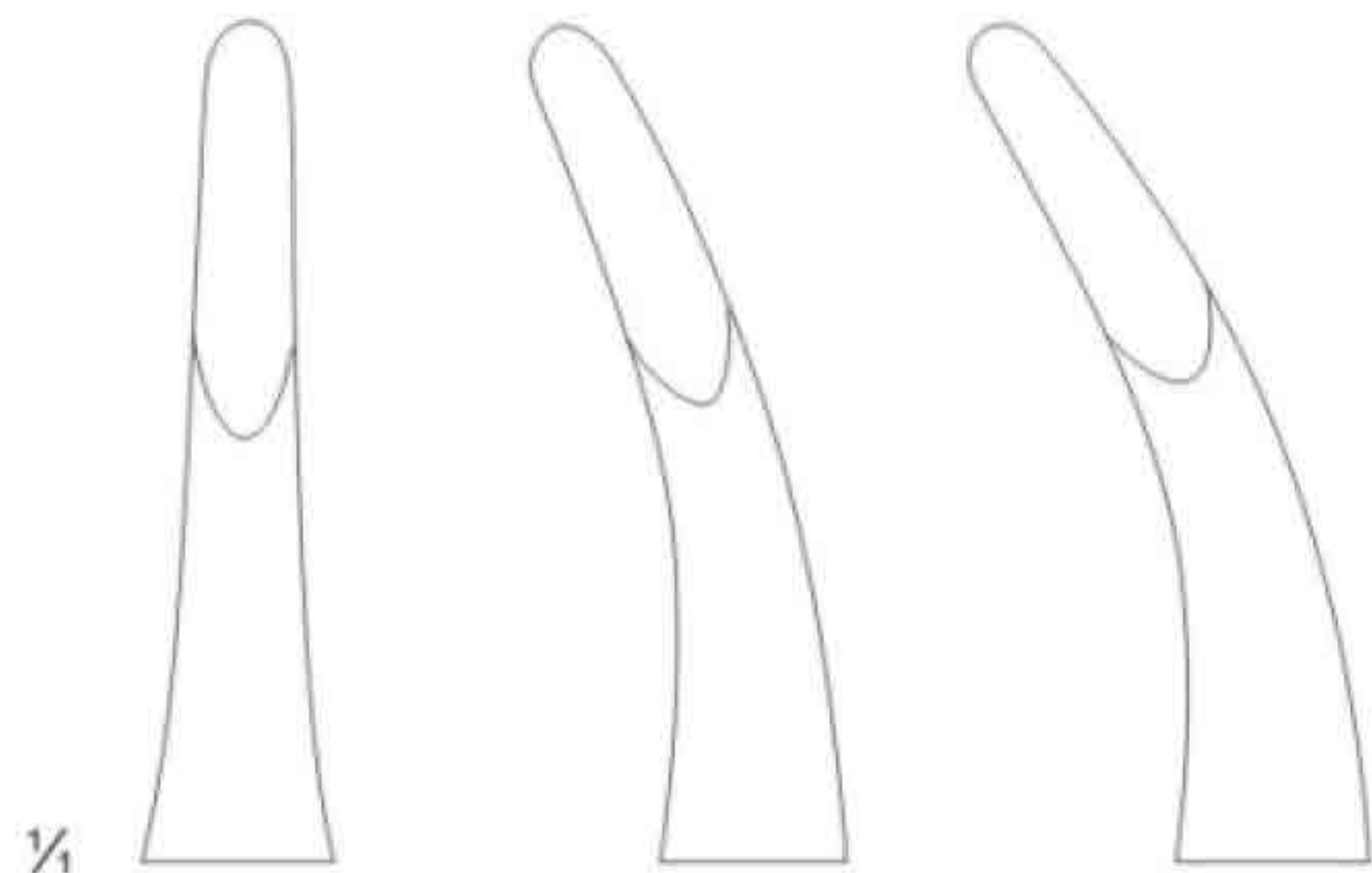


SSC-23-16-09
18.5 cm / 7 1/4"

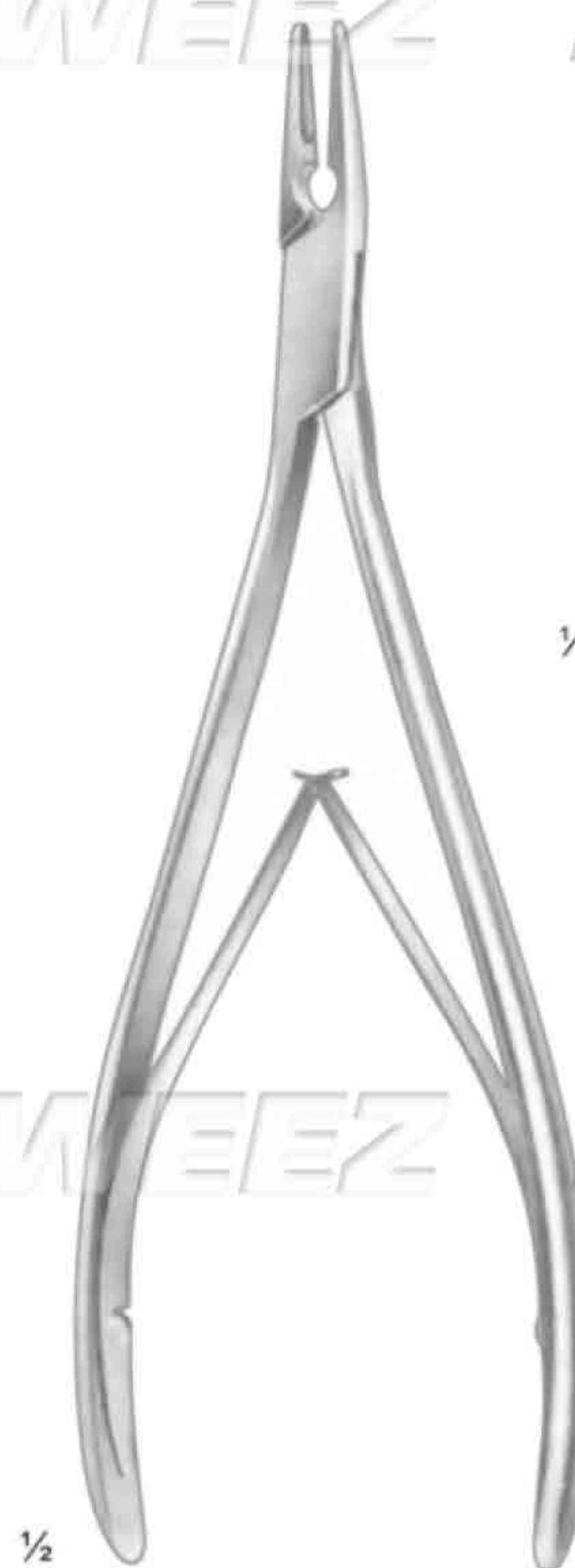
Hartmann



Jansen
18.0 cm / 7"



SSC-23-16-10 SSC-23-16-11 SSC-23-16-12

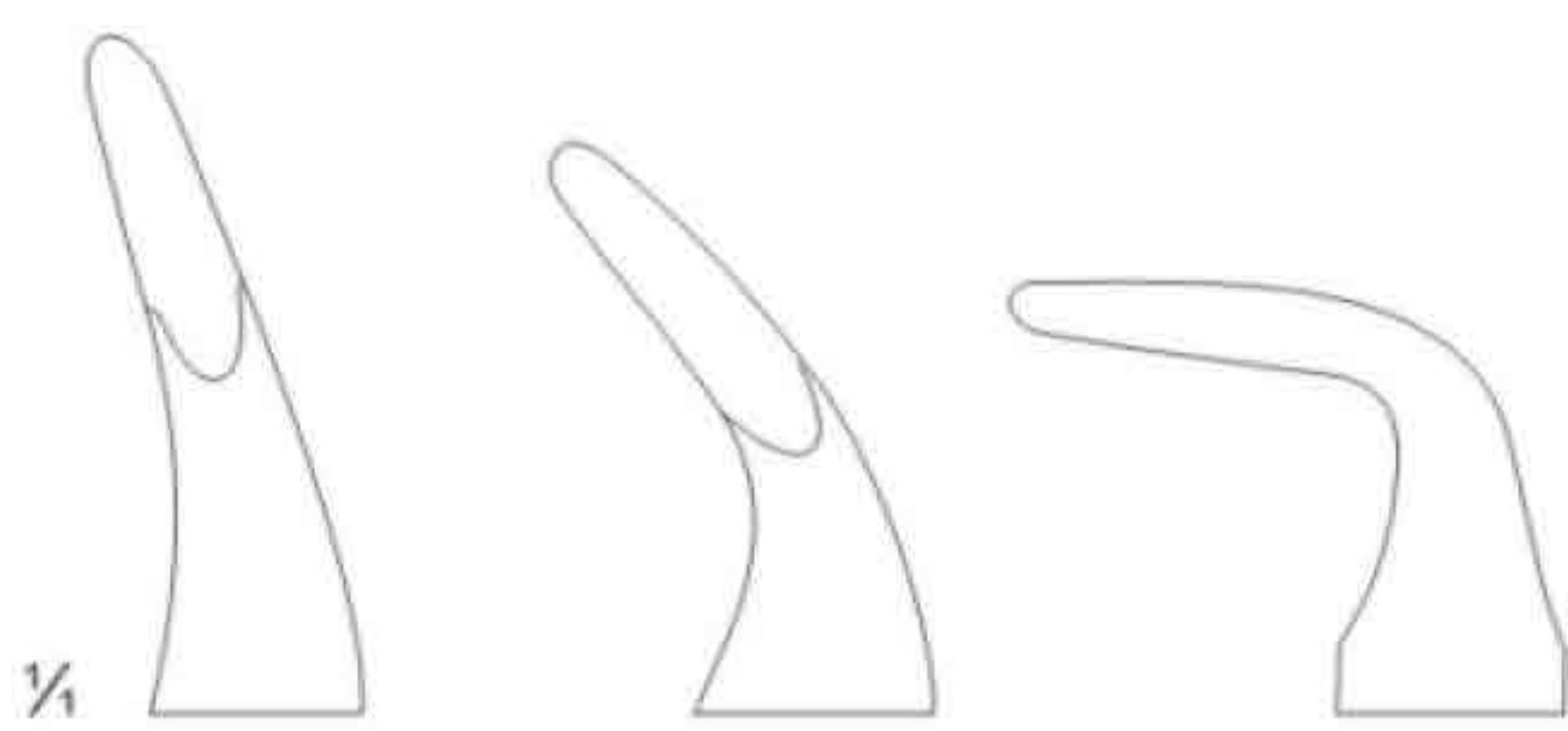


SSC-23-16-13
19.0 cm / 7 1/2"

Lempert



Blumenthal

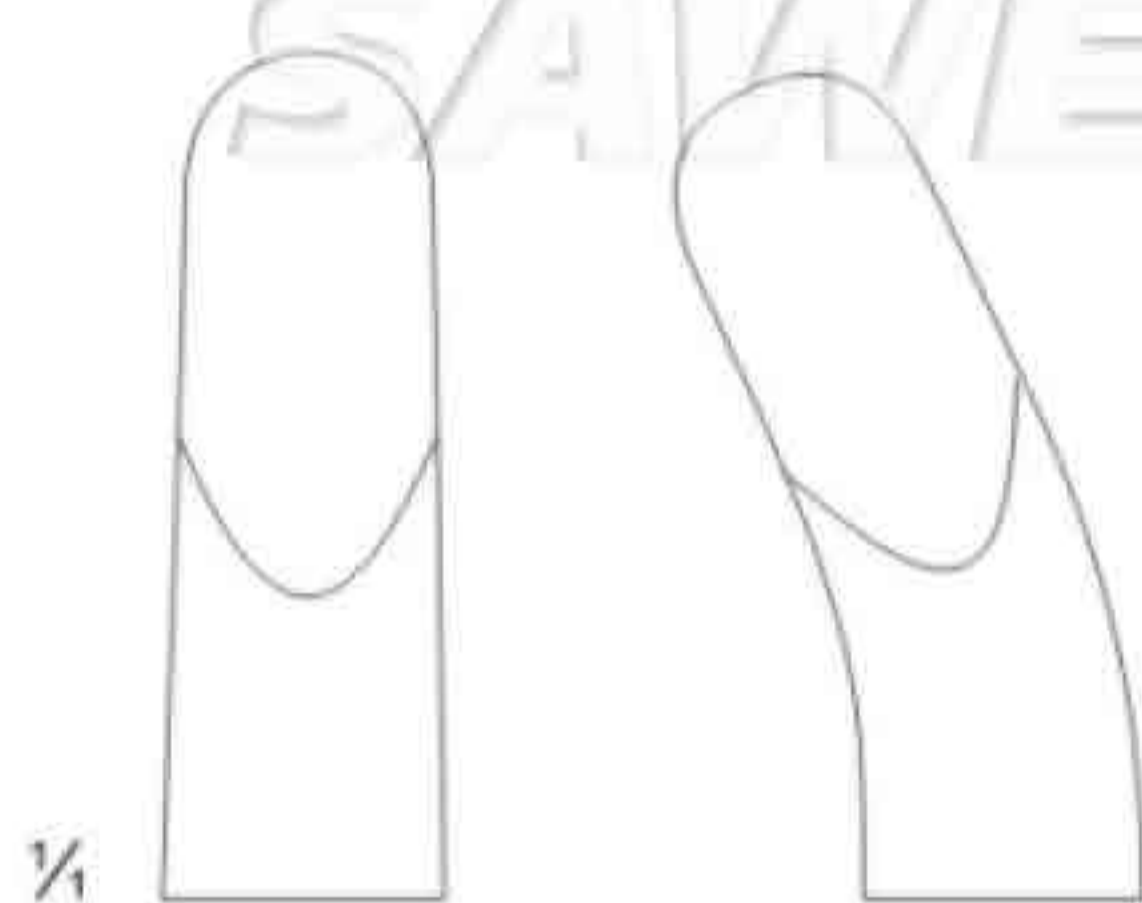


SSC-23-16-14 SSC-23-16-15 SSC-23-16-16

SAWEEZ SAWEEZ SAWEEZ SAWEEZ



Luer
17.0 cm / 6¾"



SSC-23-16-17 SSC-23-16-18

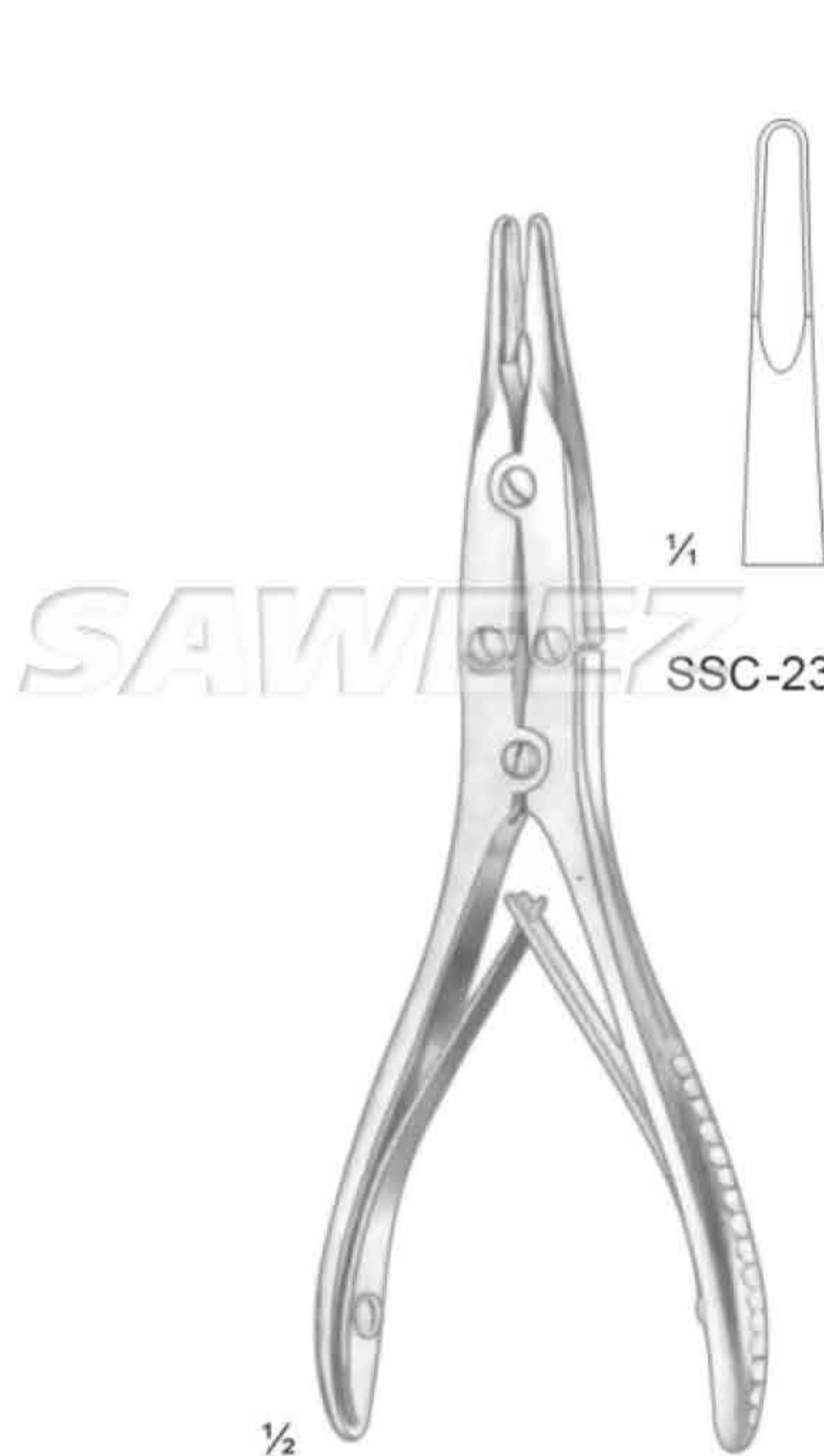


Leur
15.0 cm / 6"



SSC-23-16-19 SSC-23-16-20 SSC-23-16-21

SAWEEZ SAWEEZ SAWEEZ SAWEEZ



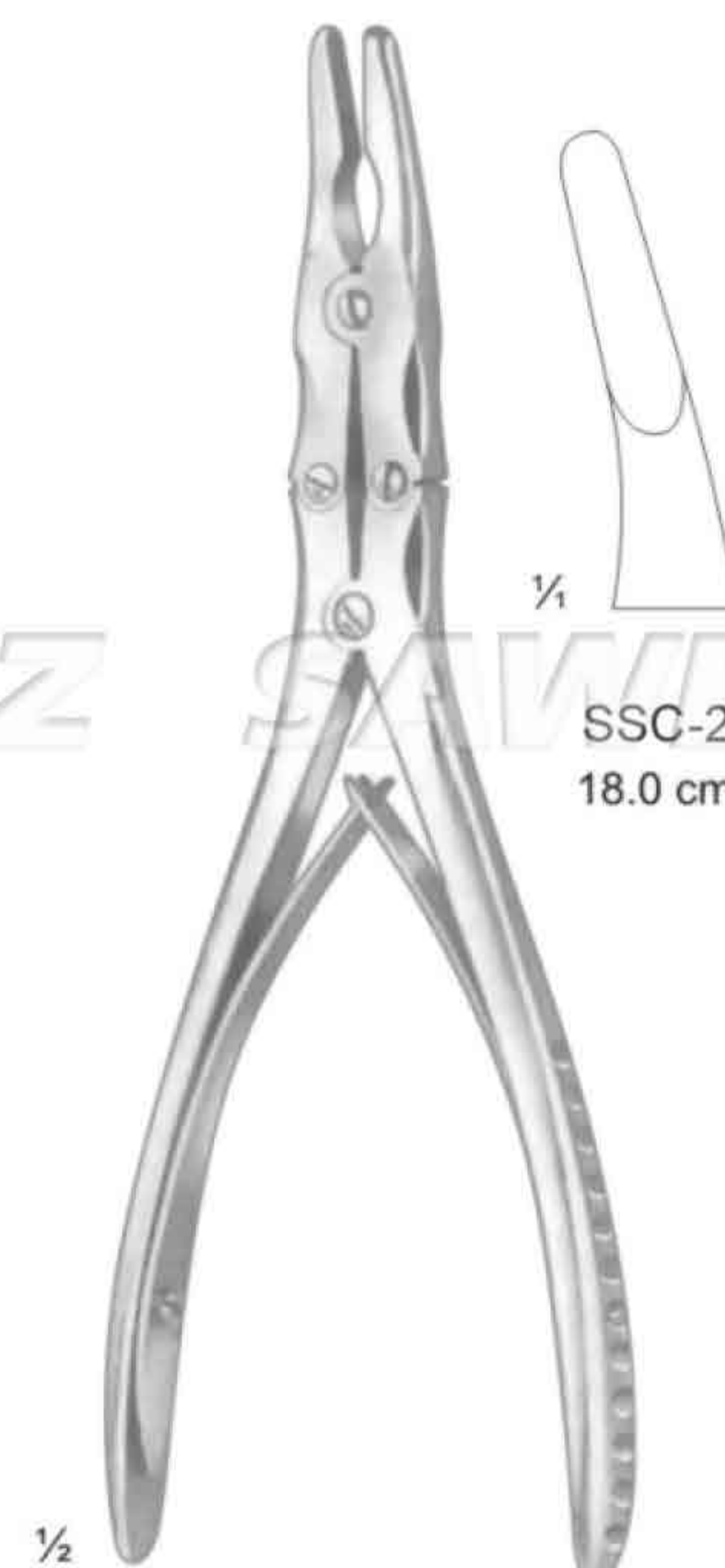
SSC-23-16-22 SSC-23-16-23

Bohler



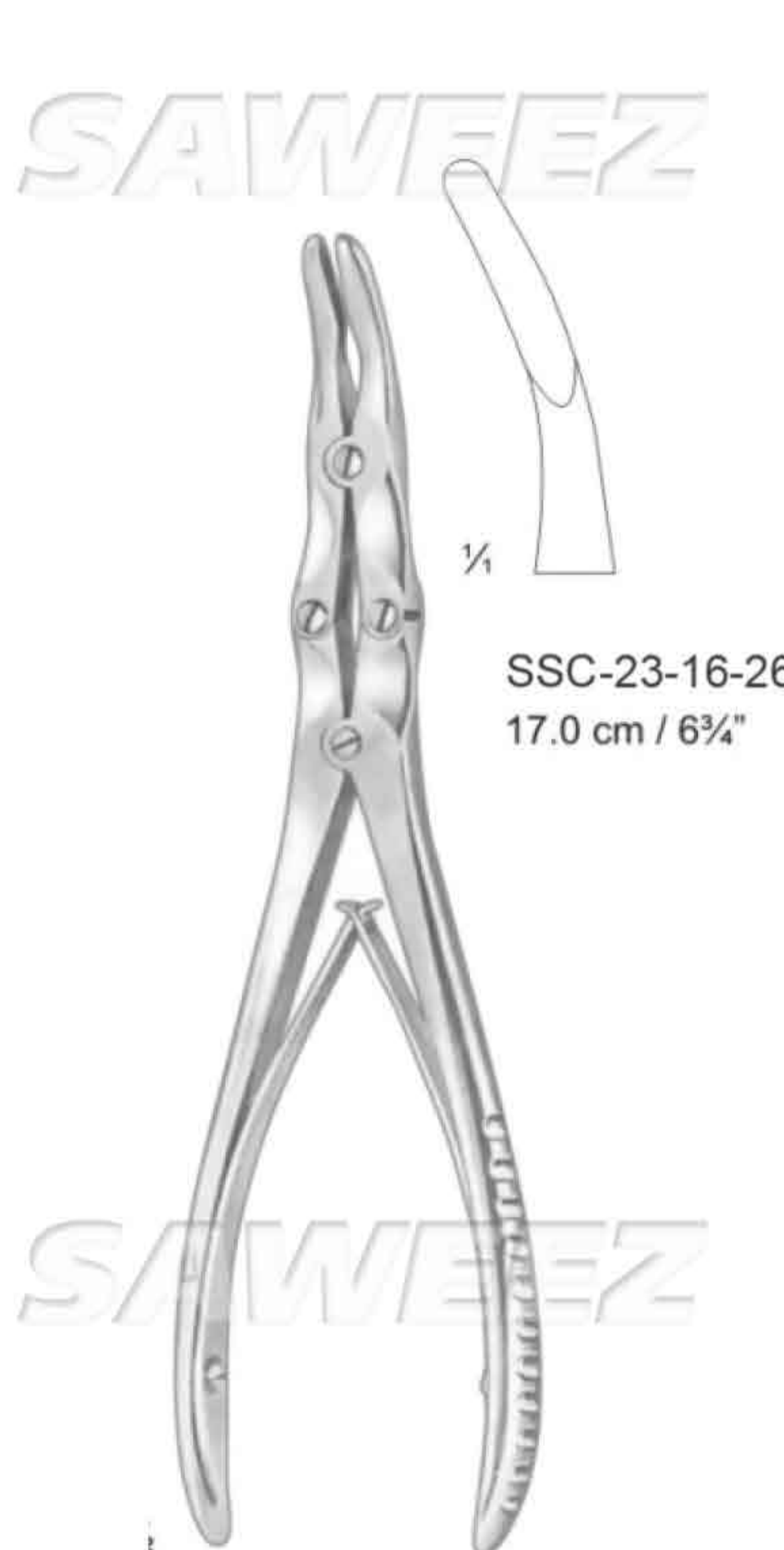
SSC-23-16-24
18.0 cm / 7"

Beyer



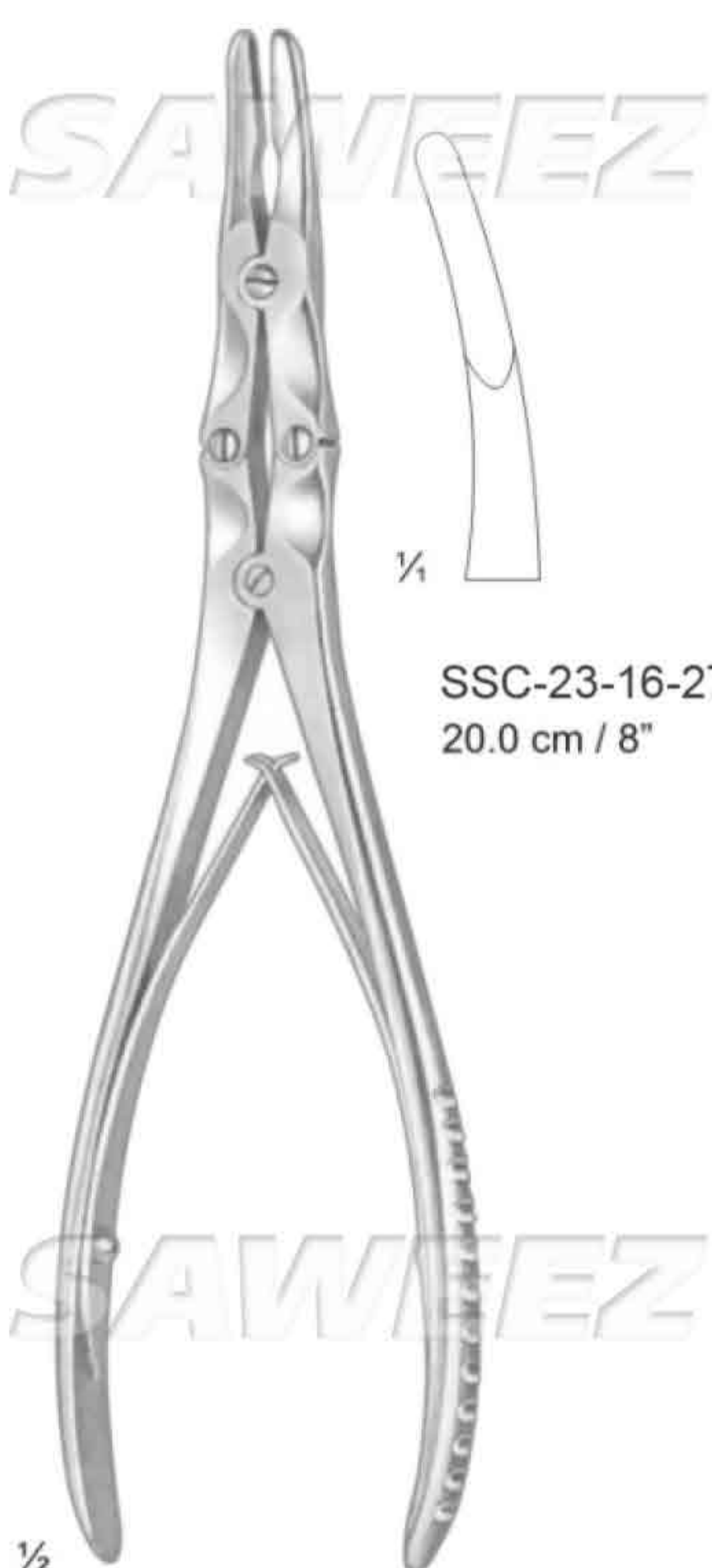
SSC-23-16-25
18.0 cm / 7"

Zaufal-Jansen



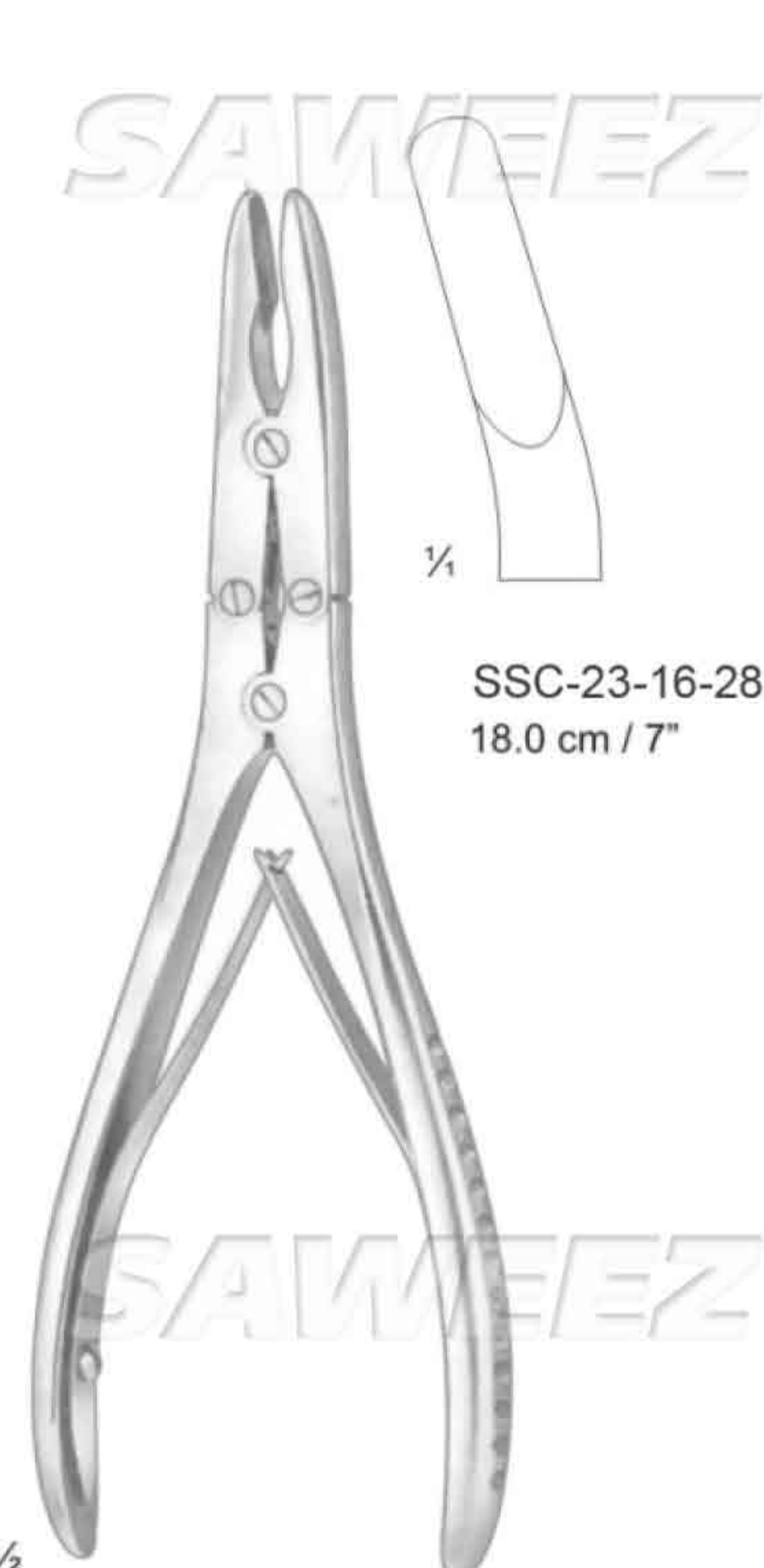
SSC-23-16-26
17.0 cm / 6 3/4"

Mayfield



SSC-23-16-27
20.0 cm / 8"

Marquardt



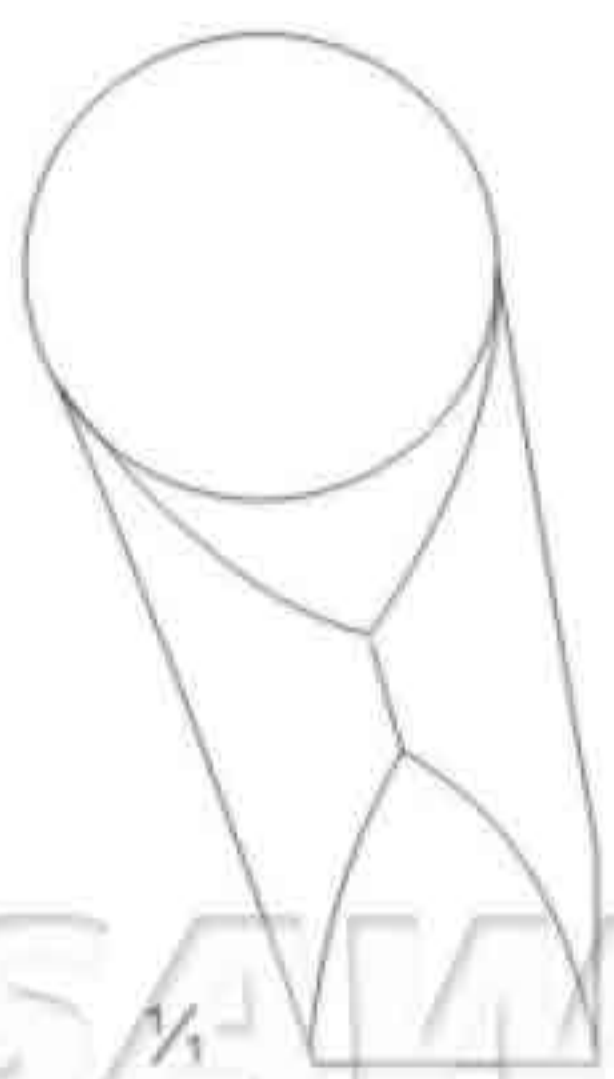
SSC-23-16-28
18.0 cm / 7"

Ruskin



SSC-23-16-29
23.0 cm / 9"

Ruskin



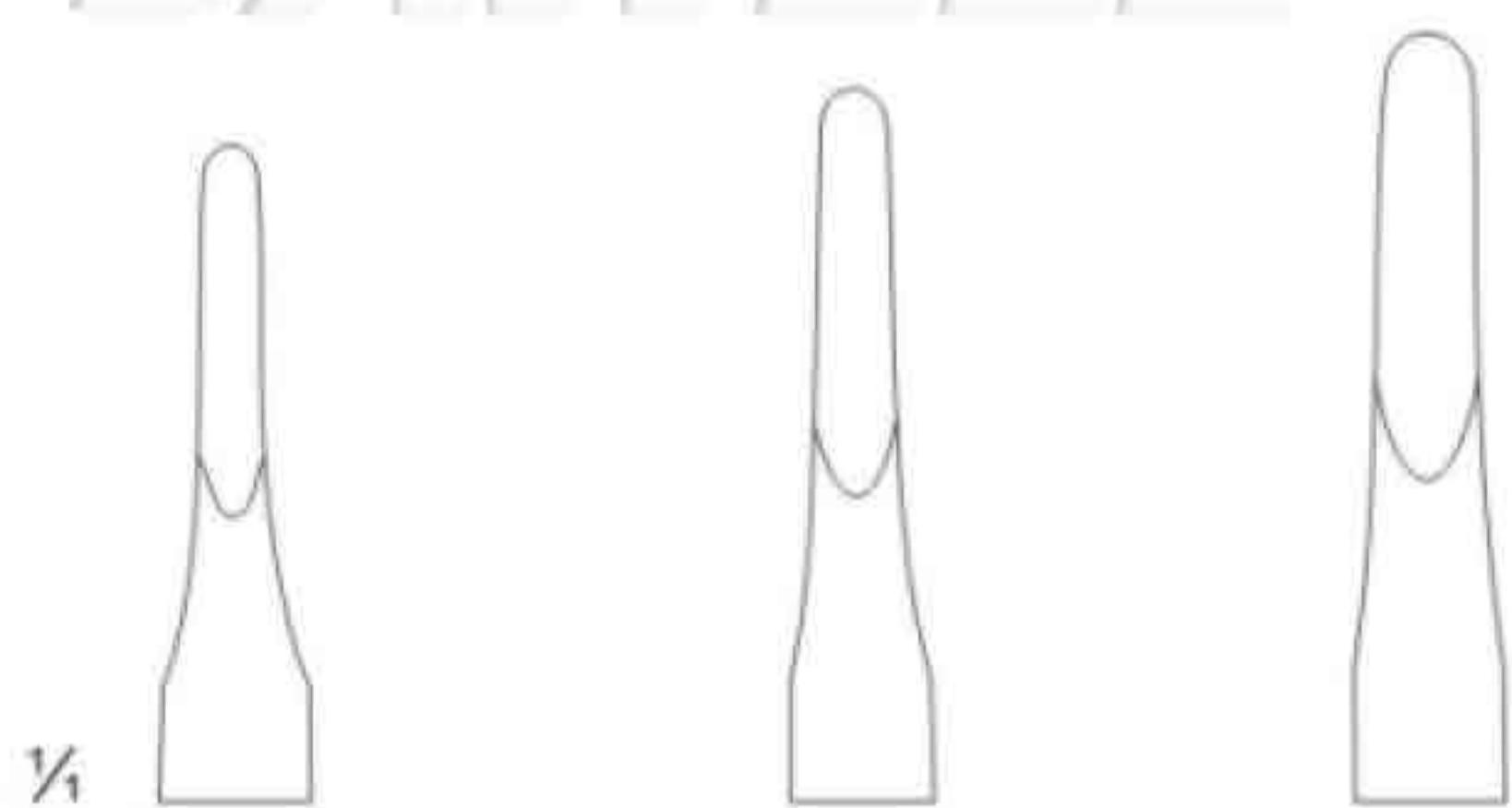
SSC-23-16-30
22.5 cm / 9"



SSC-23-16-31
23.0 cm / 9"

Semb

Stille



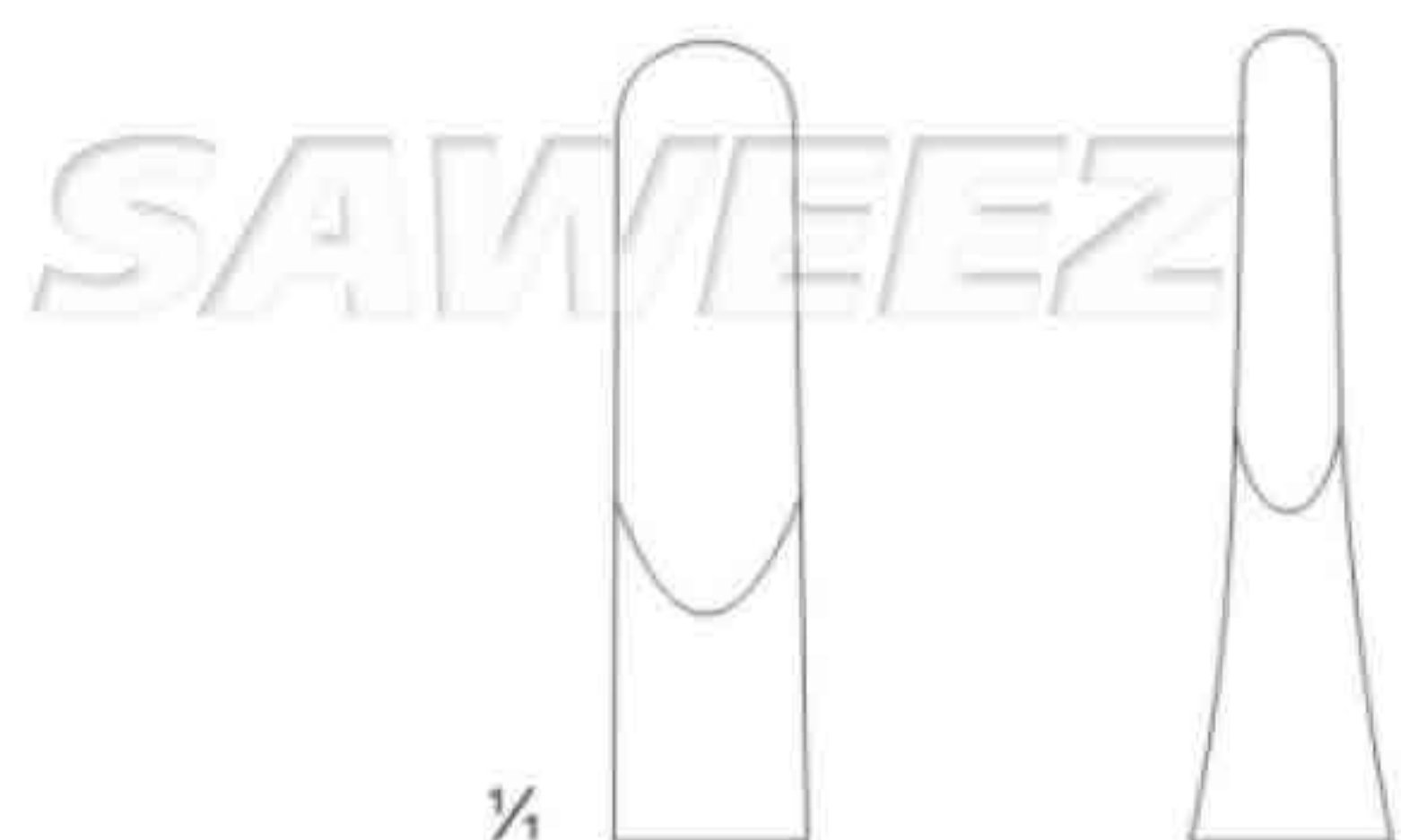
SSC-23-16-32 SSC-23-16-33 SSC-23-16-34

Echlin
23.0 cm / 9"



SSC-23-16-35
23.0 cm / 9"

Stille Ruskin



1/4

SSC-23-16-36 SSC-23-16-37



1/4

SSC-23-16-38



1/4

SSC-23-16-39 SSC-23-16-40



1/2

Leksell-Stille
22.0 cm / 9 1/2"



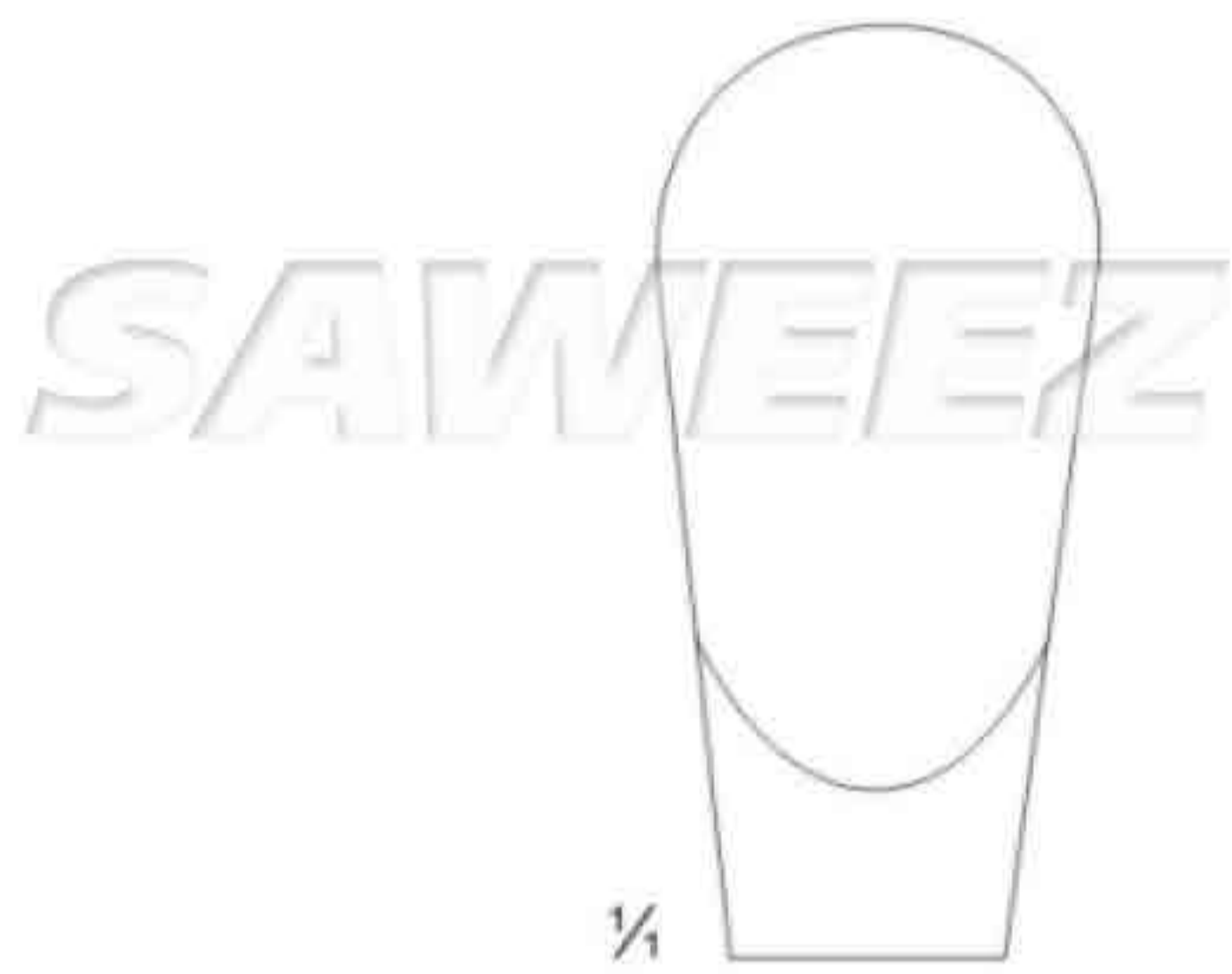
1/2

Frykholm
24.0 cm / 9 1/2"

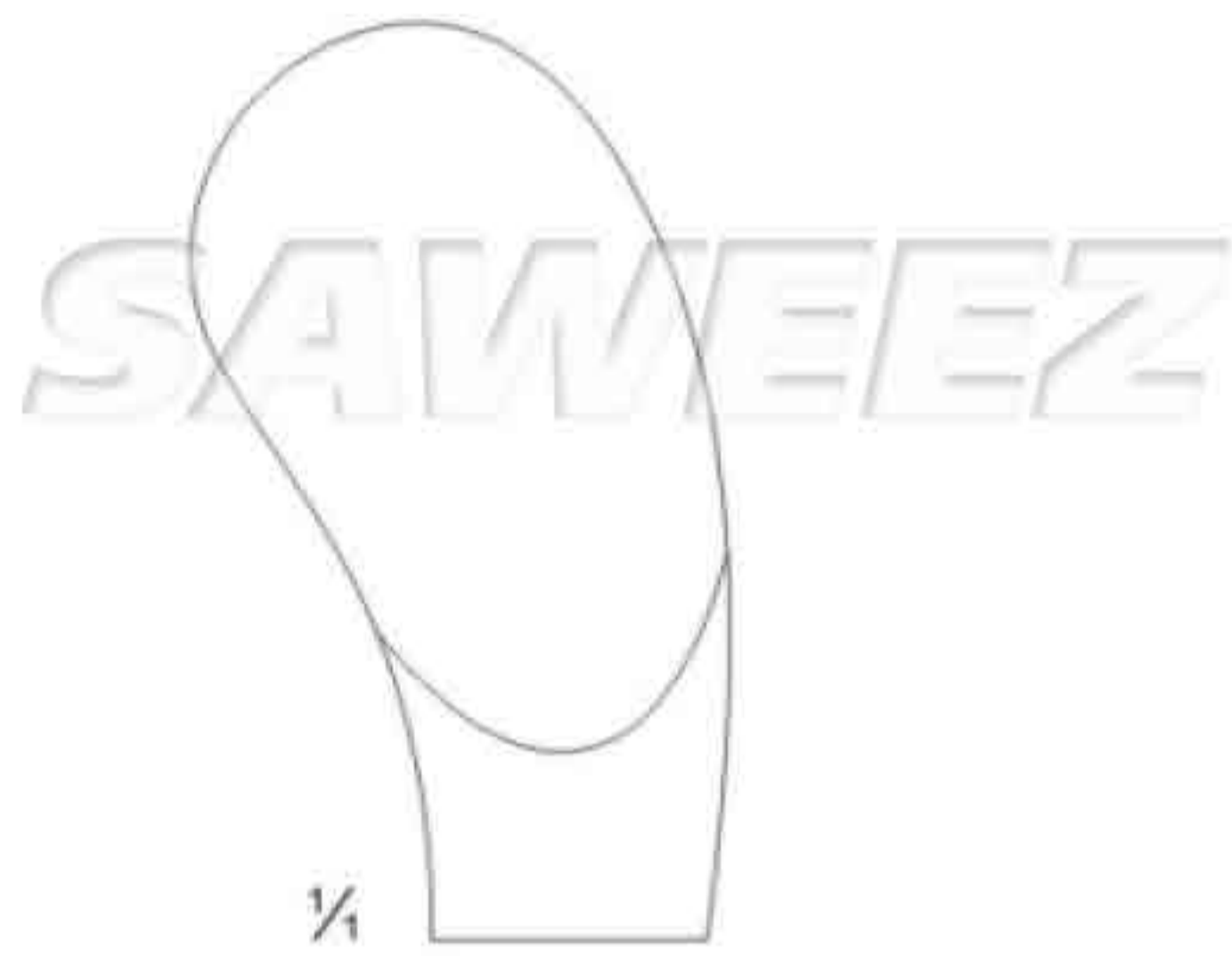


1/2

Stille-Luer
22.0 cm / 8 3/4"



SSC-23-16-41 - 23.0 cm / 9"
SSC-23-16-42 - 27.0 cm / 10½"



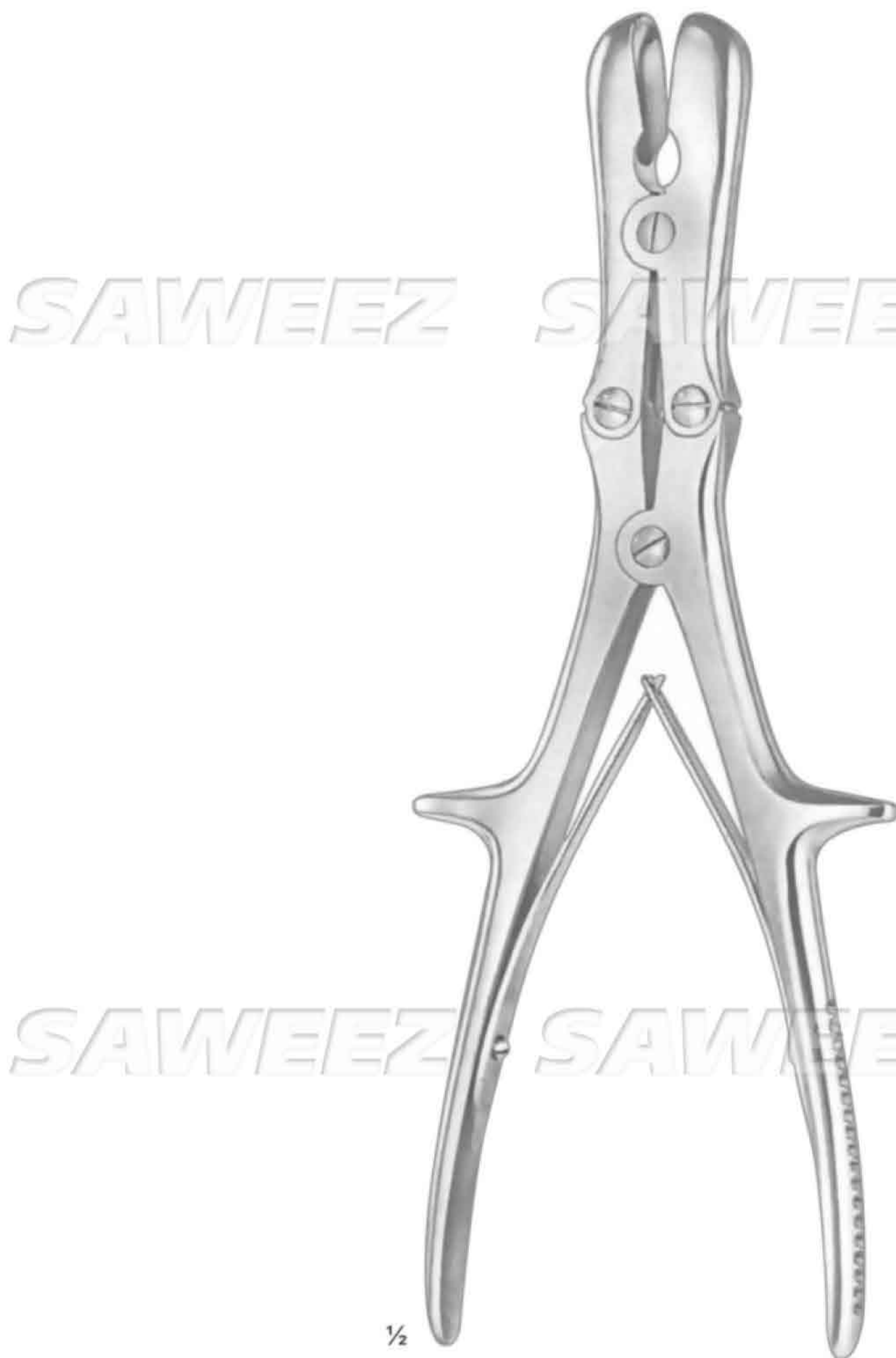
SSC-23-16-43 - 23.0 cm / 9"
SSC-23-16-44 - 27.0 cm / 10½"



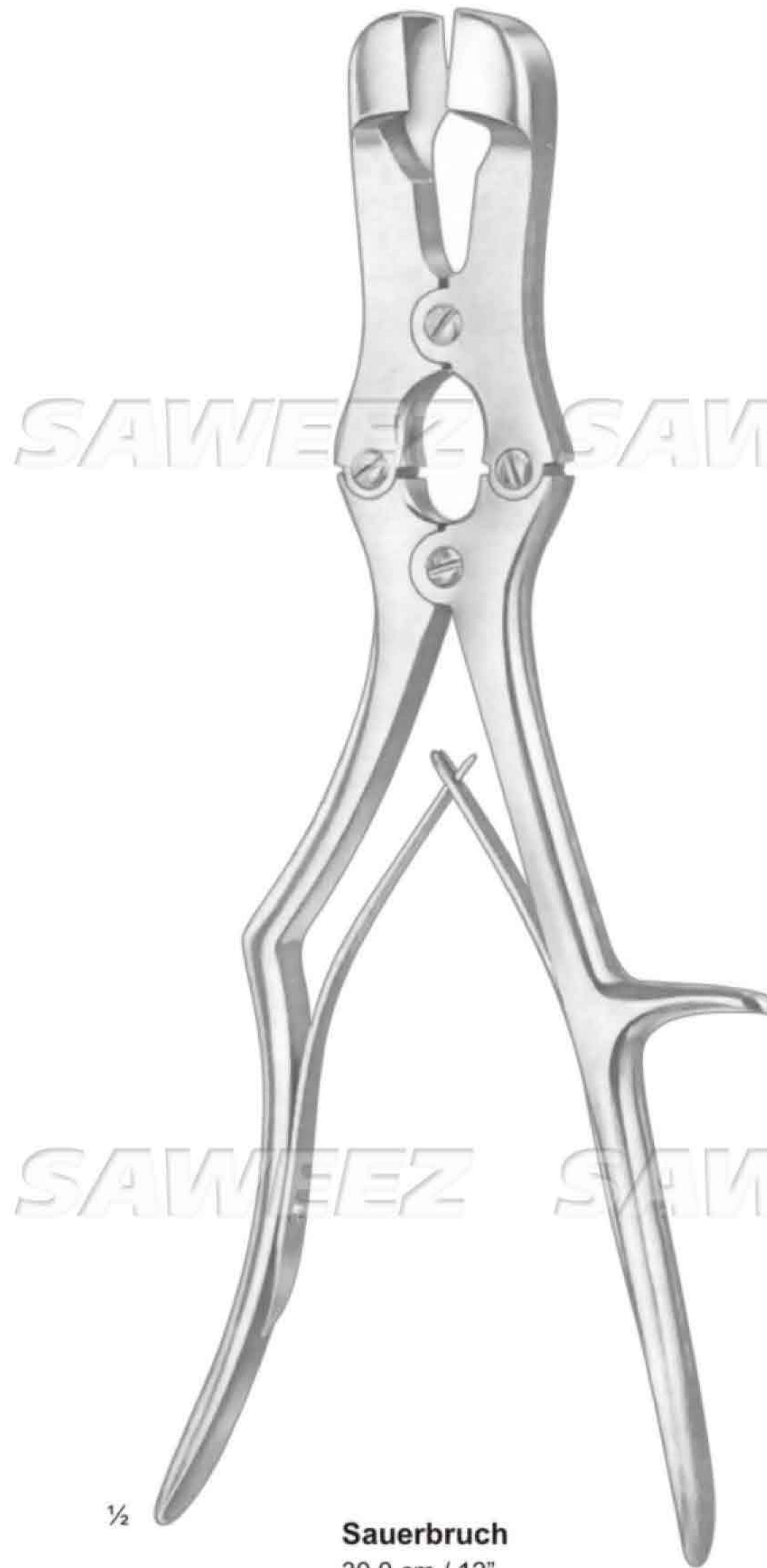
SSC-23-16-45



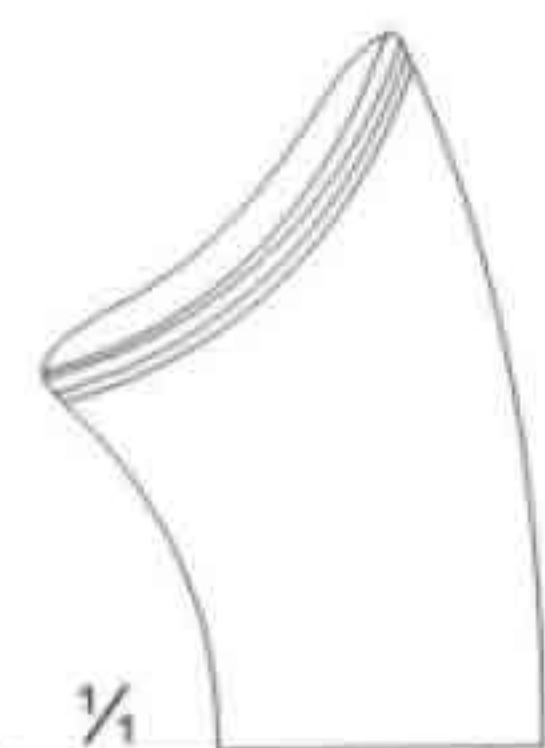
SSC-23-16-46



½
Stille-Luer



½
Sauerbruch
30.0 cm / 12"



SSC-23-16-47
20.0 cm / 8"

1/2

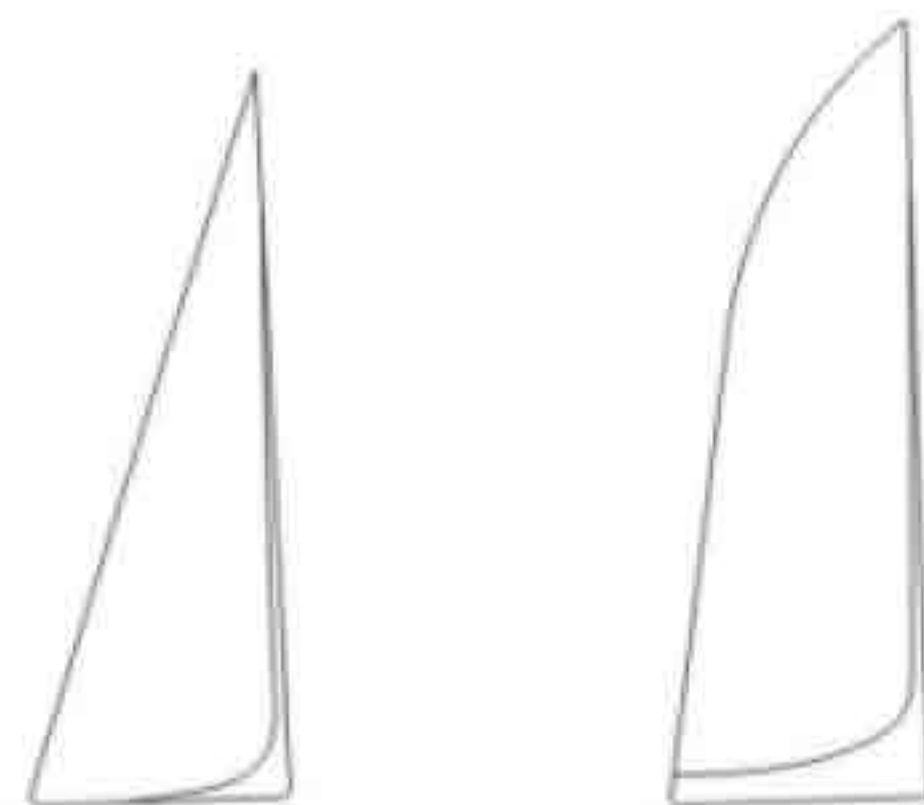
Markwalder



SSC-23-16-48
19.0 cm / 7 1/2"

1/2

Cottle-Kazanjian



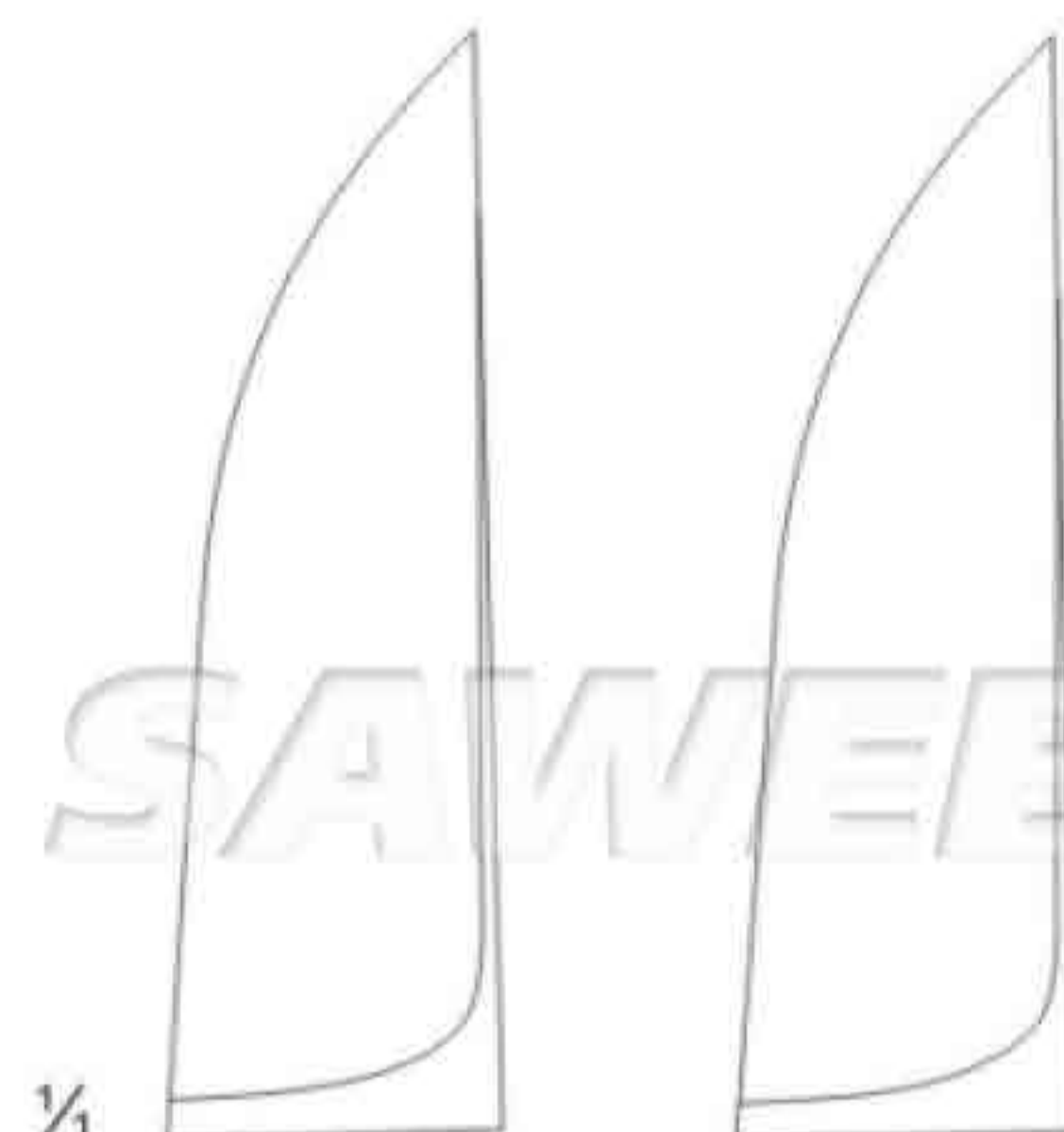
SSC-23-16-49
14.0 cm / 5 1/2"

SSC-23-16-50
17.0 cm / 6 3/4"



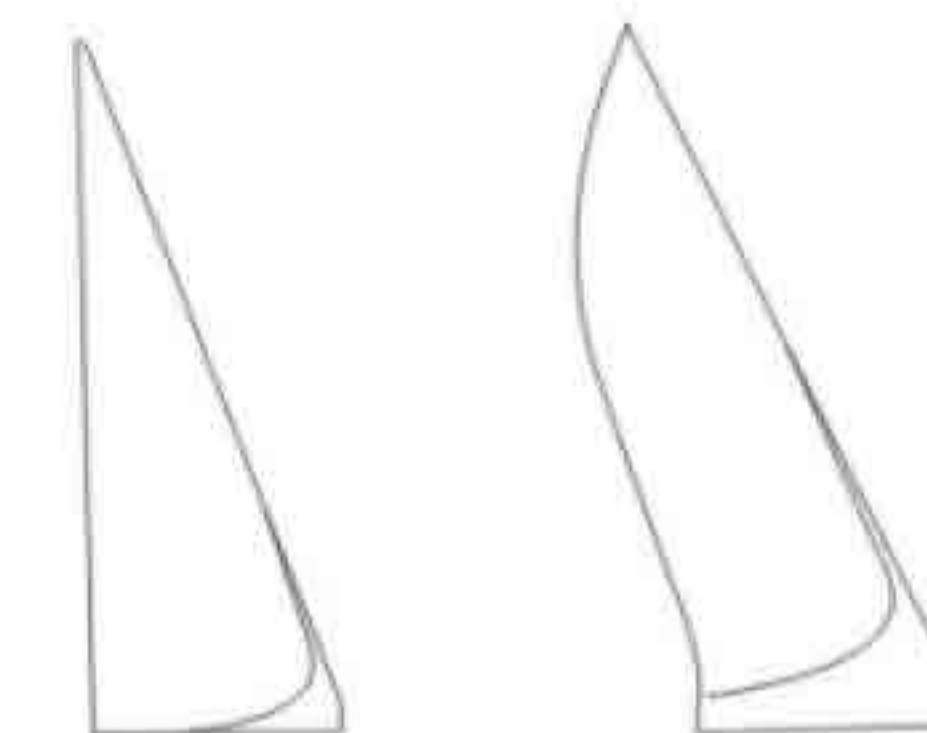
1/2

Liston



SSC-23-16-51
19.0 cm / 7 1/2"

SSC-23-16-52
22.0 cm / 8 3/4"



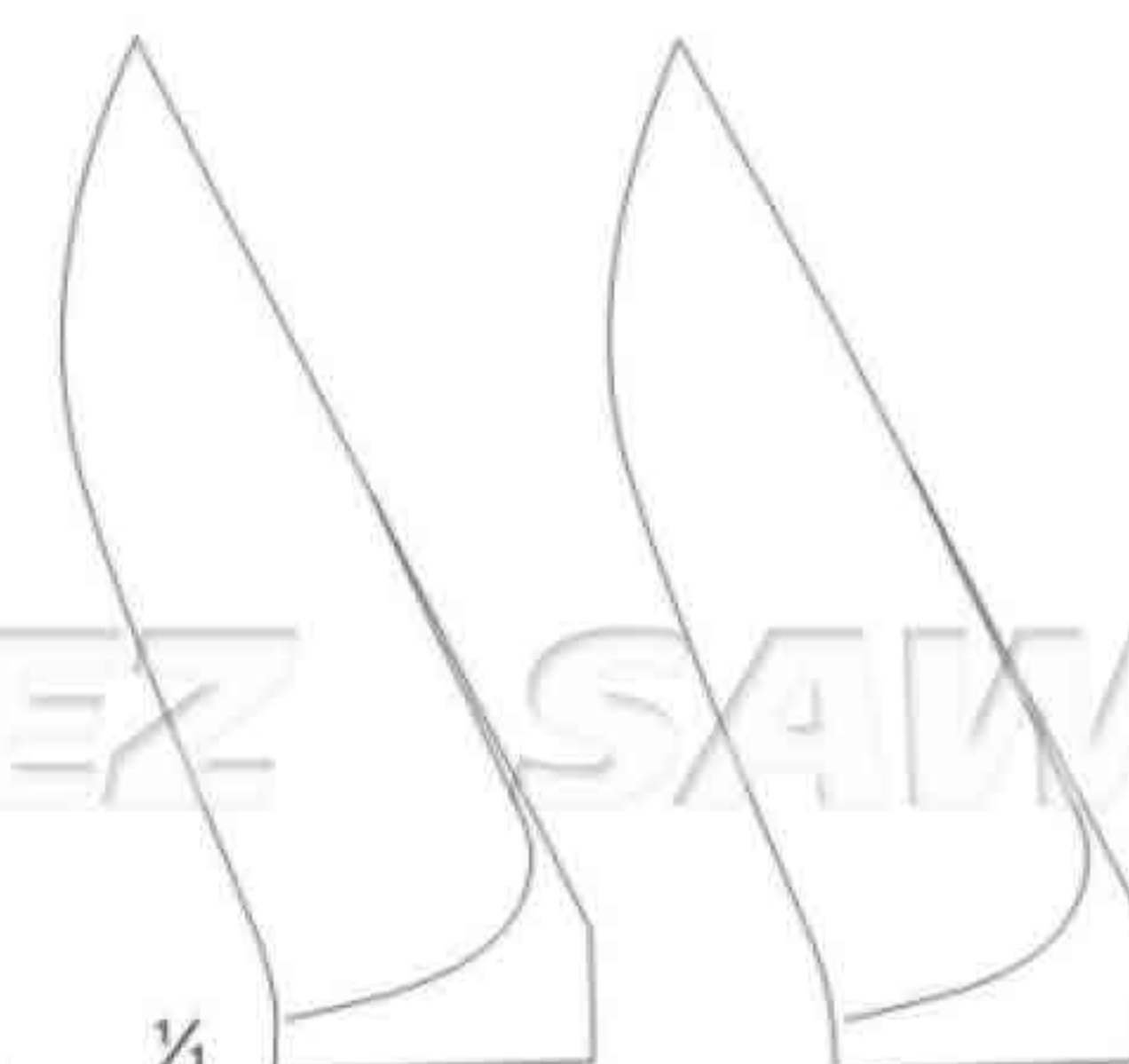
SSC-23-16-53
14.0 cm / 5 1/2"

SSC-23-16-54
17.0 cm / 6 3/4"



1/2

Liston



SSC-23-16-55
19.0 cm / 7 1/2"

SSC-23-16-56
22.0 cm / 8 3/4"



1/4



SSC-23-16-57
17.0 cm / 6 3/4"

Cleveland



1/4



SSC-23-16-58
15.0 cm / 6"

Cleveland



1/4



SSC-23-16-59
12.0 cm / 4 3/4"

1/2



1/2



1/4



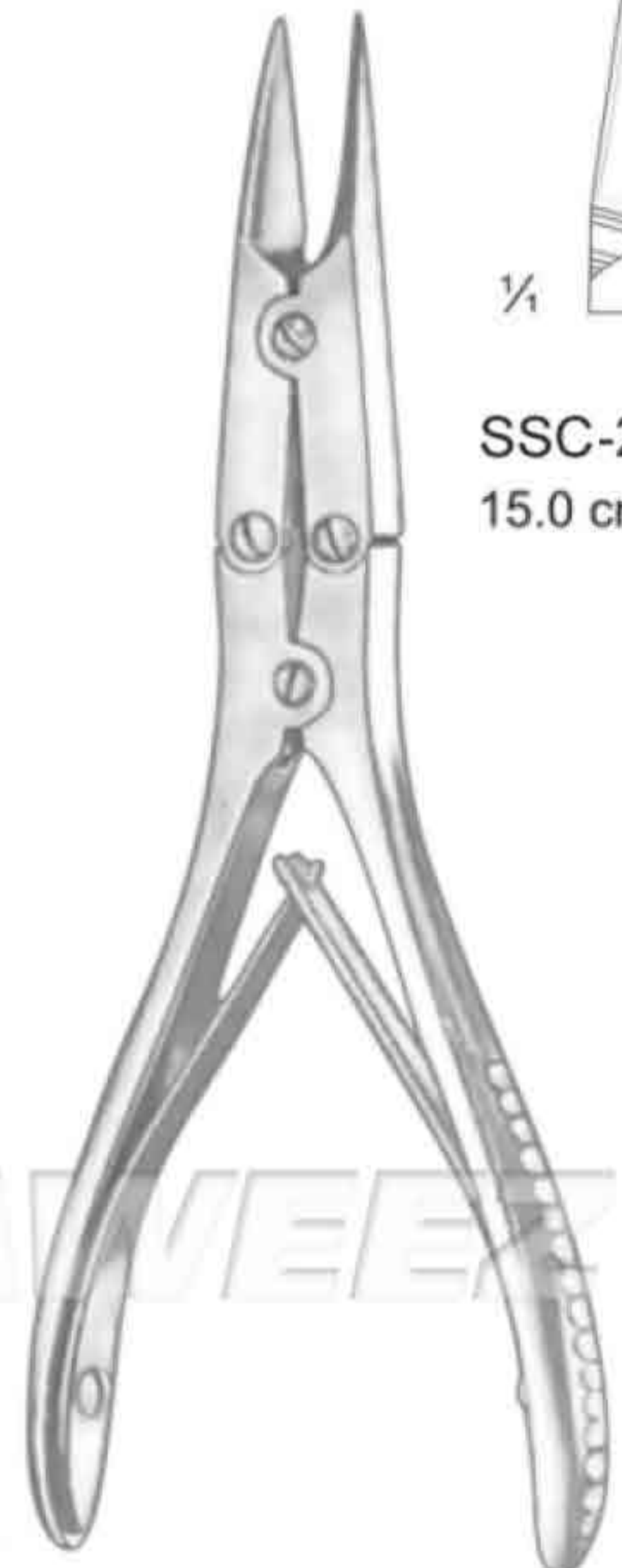
SSC-23-16-61 SSC-23-16-62

Cleveland
16.0 cm / 6 1/4"



SAWEEZ SAWEEZ SAWEEZ SAWEEZ

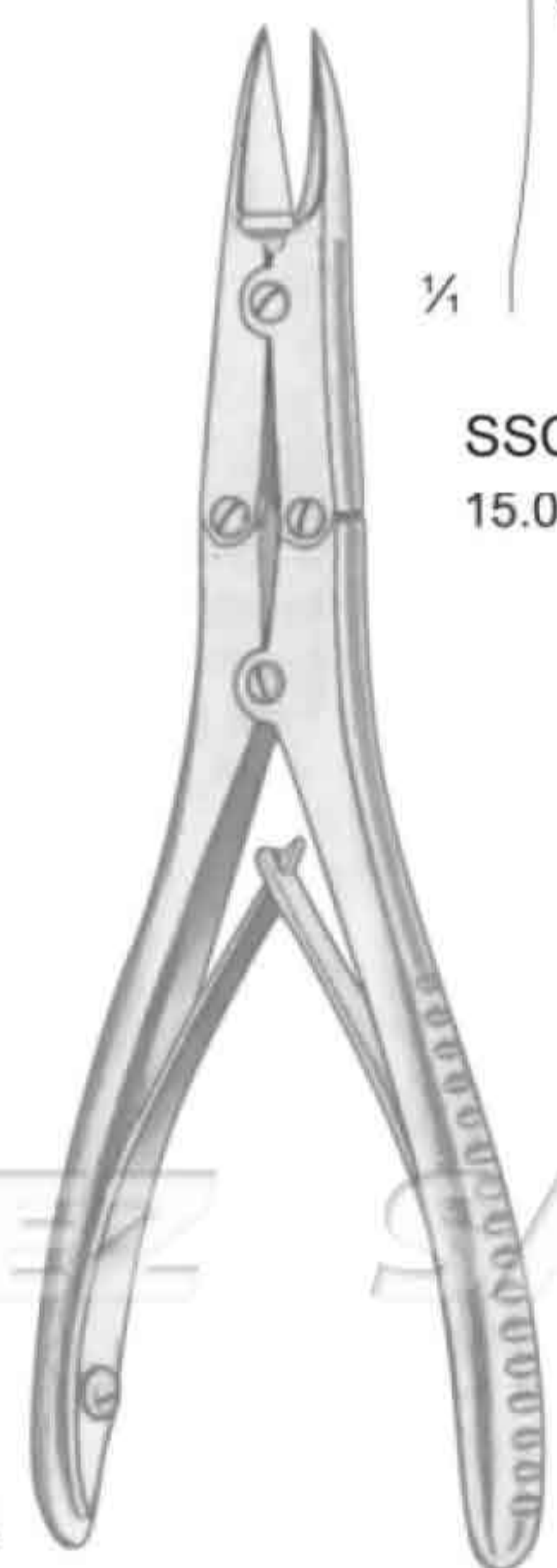
SAWEEZ SAWEEZ SAWEEZ SAWEEZ



SSC-23-16-63
15.0 cm / 6"



SSC-23-16-64
15.0 cm / 6"



SSC-23-16-65
15.0 cm / 6"



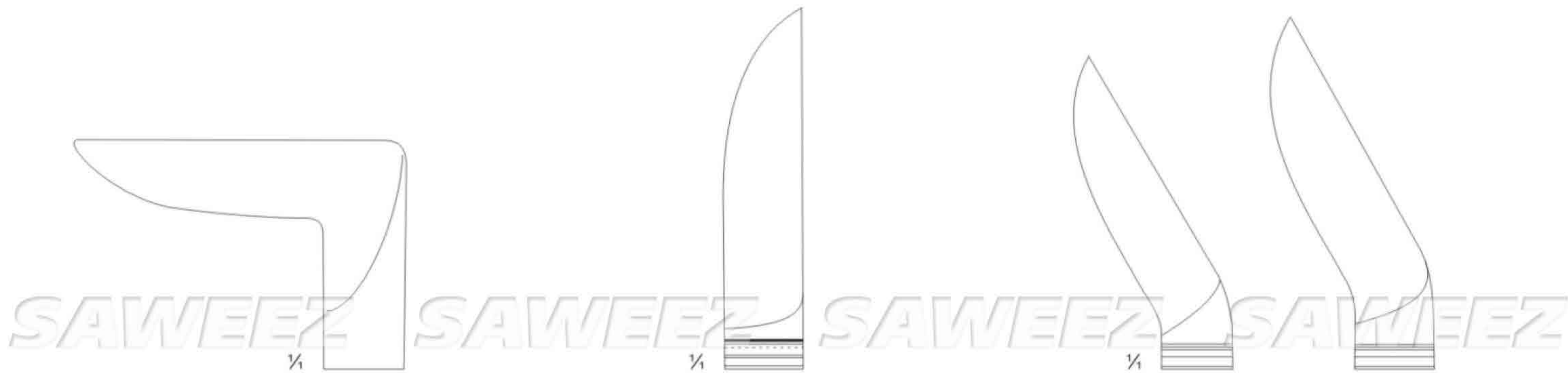
SSC-23-16-66
18.5 cm / 7 1/4"



SSC-23-16-67
18.5 cm / 7 1/4"

SAWEEZ SAWEEZ SAWEEZ SAWEEZ

Ruskin-Liston

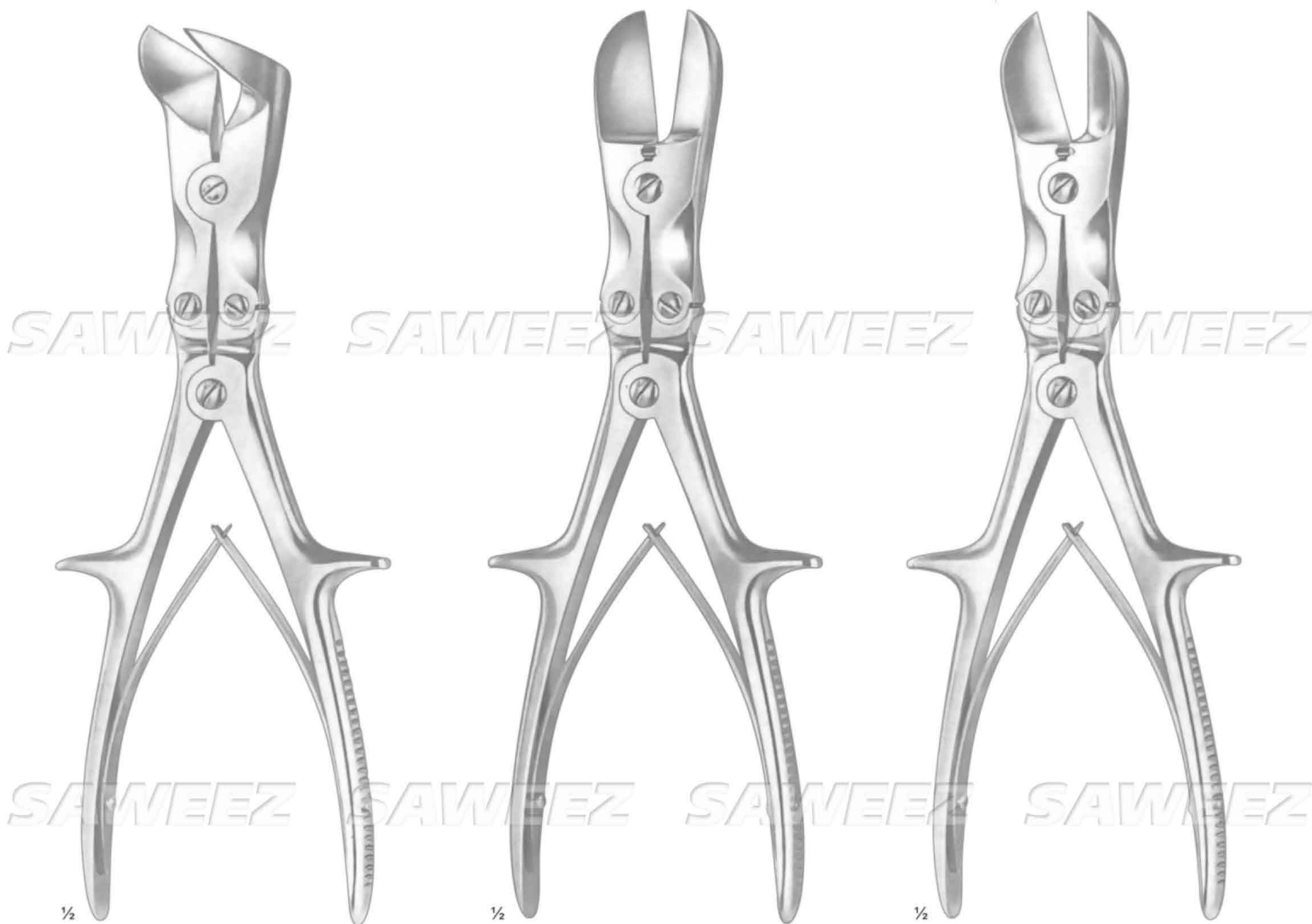


SSC-23-16-68
27.0 cm / 10½"

SSC-23-16-69
27.0 cm / 10½"

SSC-23-16-70
23.0 cm / 9¼"

SSC-23-16-71
27.0 cm / 10½"



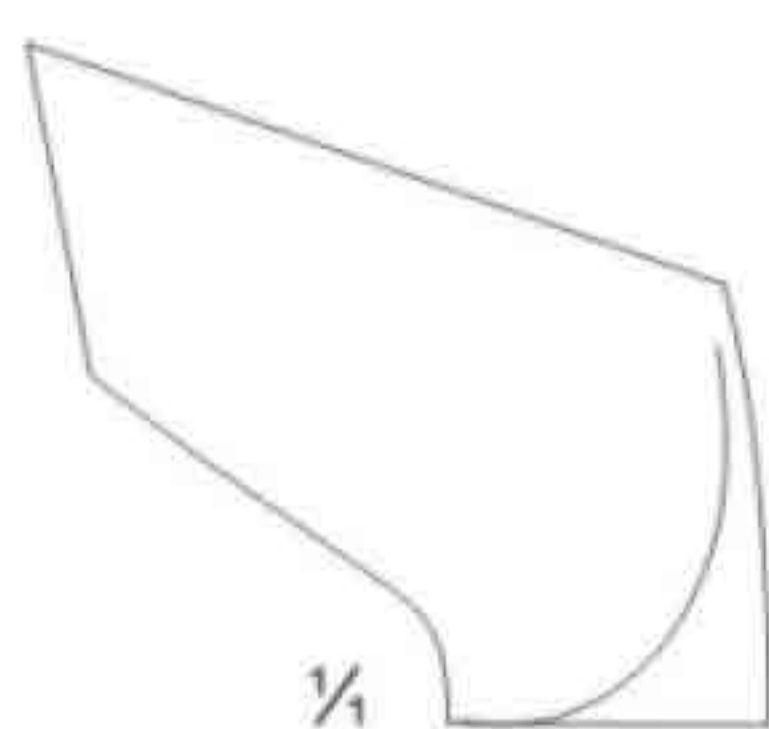
Stille-Liston

Stille-Liston

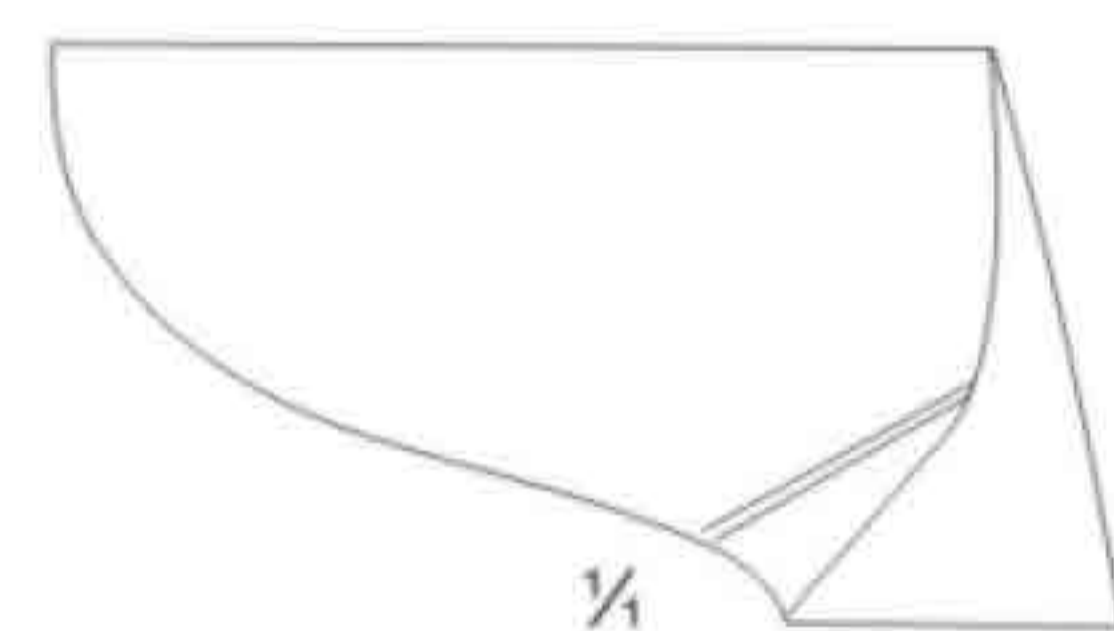
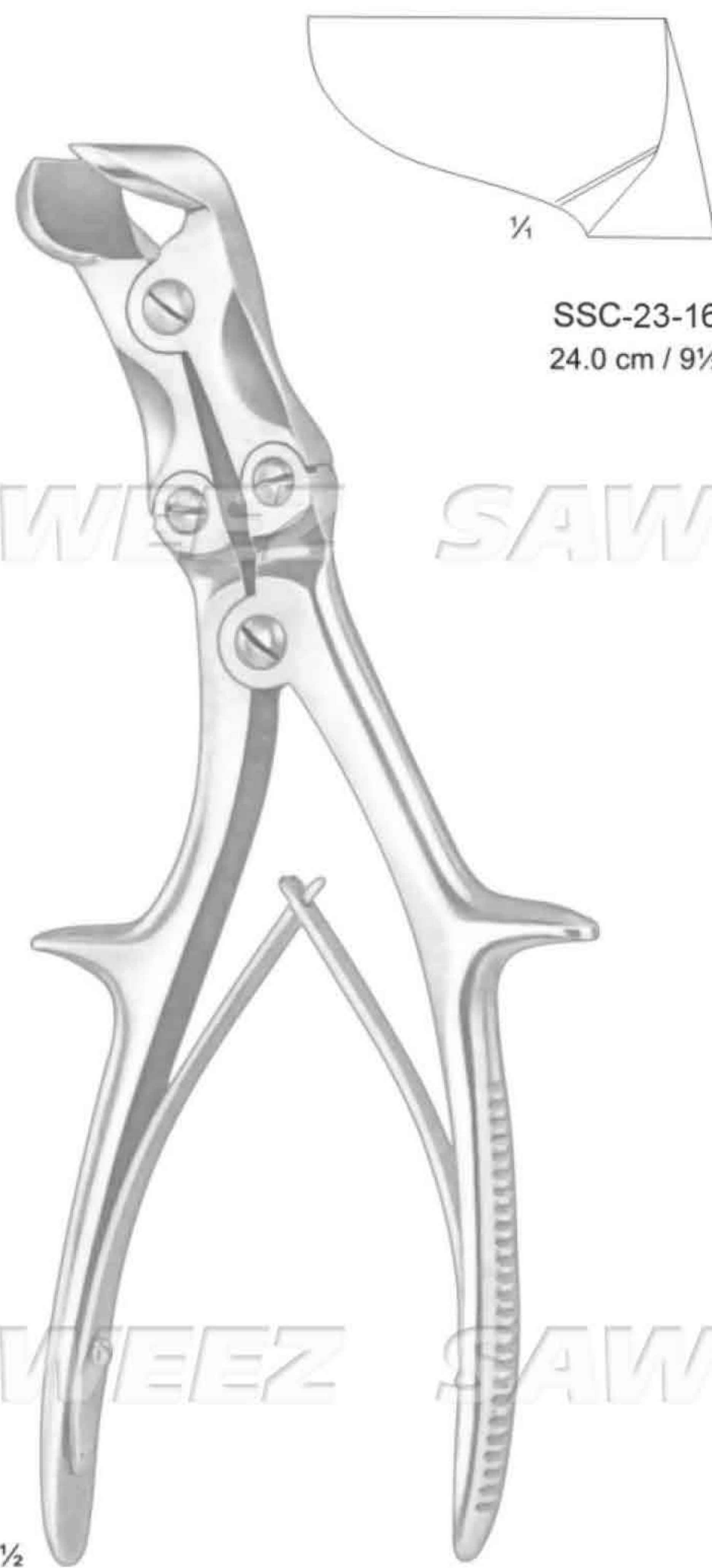
Liston-Key



SAWEEZ SAWEEZ SAWEEZ SAWEEZ



SSC-23-16-72
27.0 cm / 10½"



SSC-23-16-73
24.0 cm / 9½"

SAWEEZ SAWEEZ SAWEEZ SAWEEZ

SAWEEZ SAWEEZ SAWEEZ SAWEEZ

Liston-Key

Semb



SSC-23-16-74

1/2

Special Model
SSC-23-16-77
17.0 cm / 6 3/4"



SSC-23-16-75

1/2

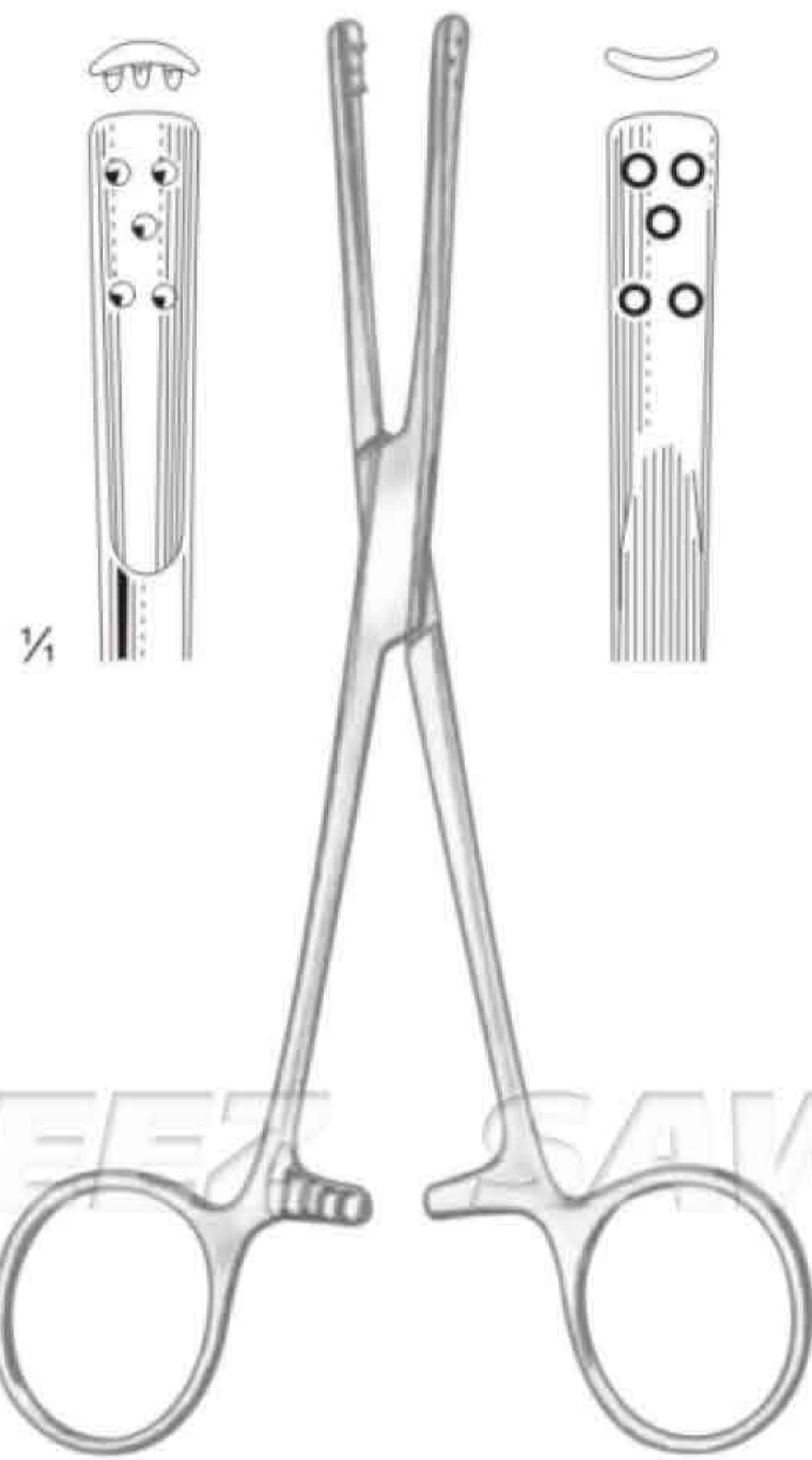
Walton
SSC-23-16-78
16.0 cm / 6 1/4"



SSC-23-16-76

1/2

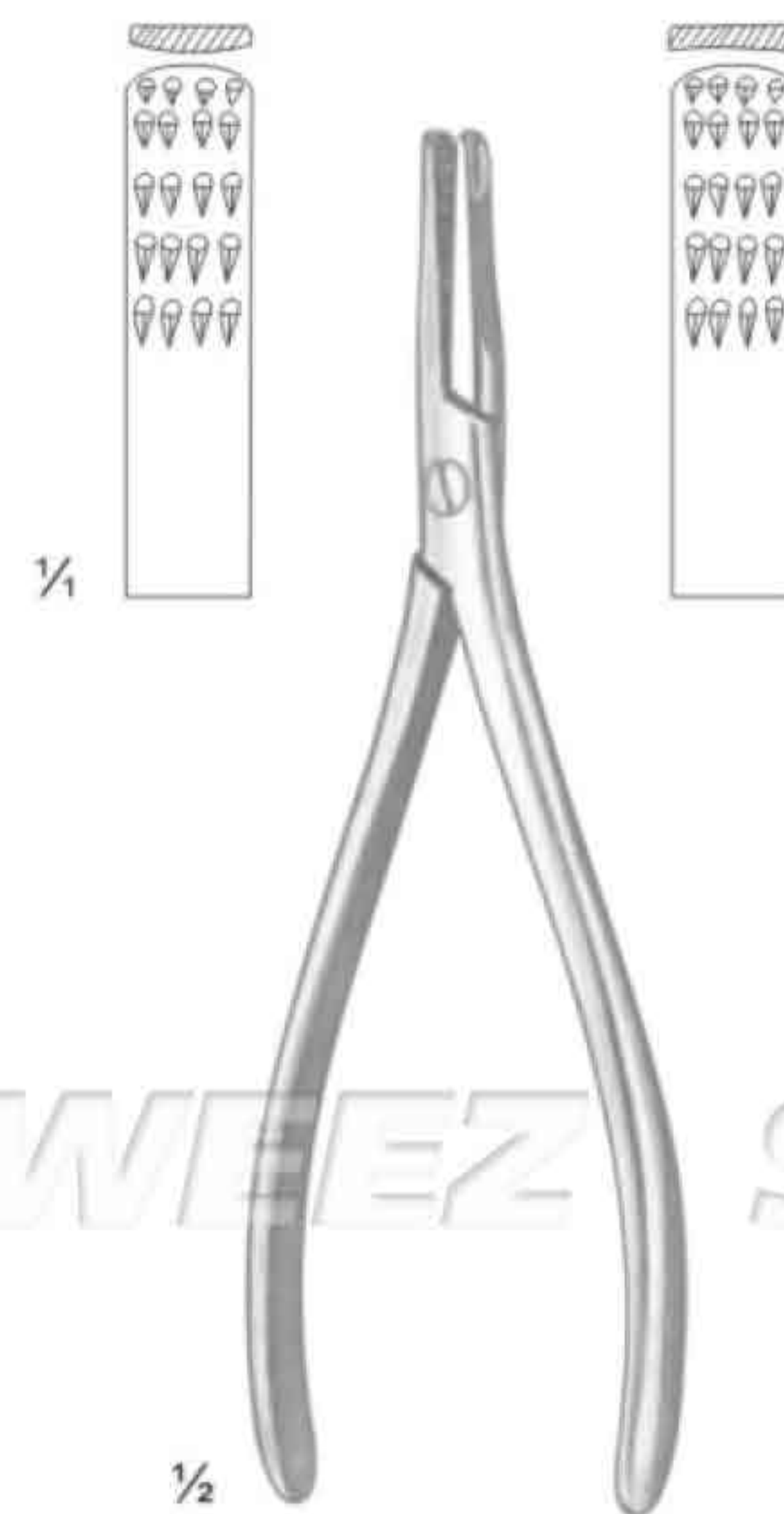
SSC-23-16-79
17.0 cm / 6 3/4"



1/4

1/2

Penner
SSC-23-16-80
15.5 cm / 6"



1/4

1/2

Radolf
SSC-23-16-81
13.5 cm / 5 1/4"



Spare saw blade
SSC-23-16-80 - 12.0 mm
SSC-23-16-81 - 15.0 mm



¼

Charriere
SSC-23-16-82
35.0 cm / 14"



Spare saw blade
SSC-23-16-83 - 3 mm
SSC-23-16-84 - 5mm
SSC-23-16-85 - 7 mm



¼

Helferich-Bier
SSC-23-16-86
39.0 cm / 15½"



⅓

Lindemann
SSC-23-16-87
20.0 cm / 8"



⅓

Langenbeck
SSC-23-16-88
23.0 cm / 9"



¼

Charriere
SSC-23-16-89 - 27 cm / 10½"
SSC-23-16-90 - 30 cm / 12"



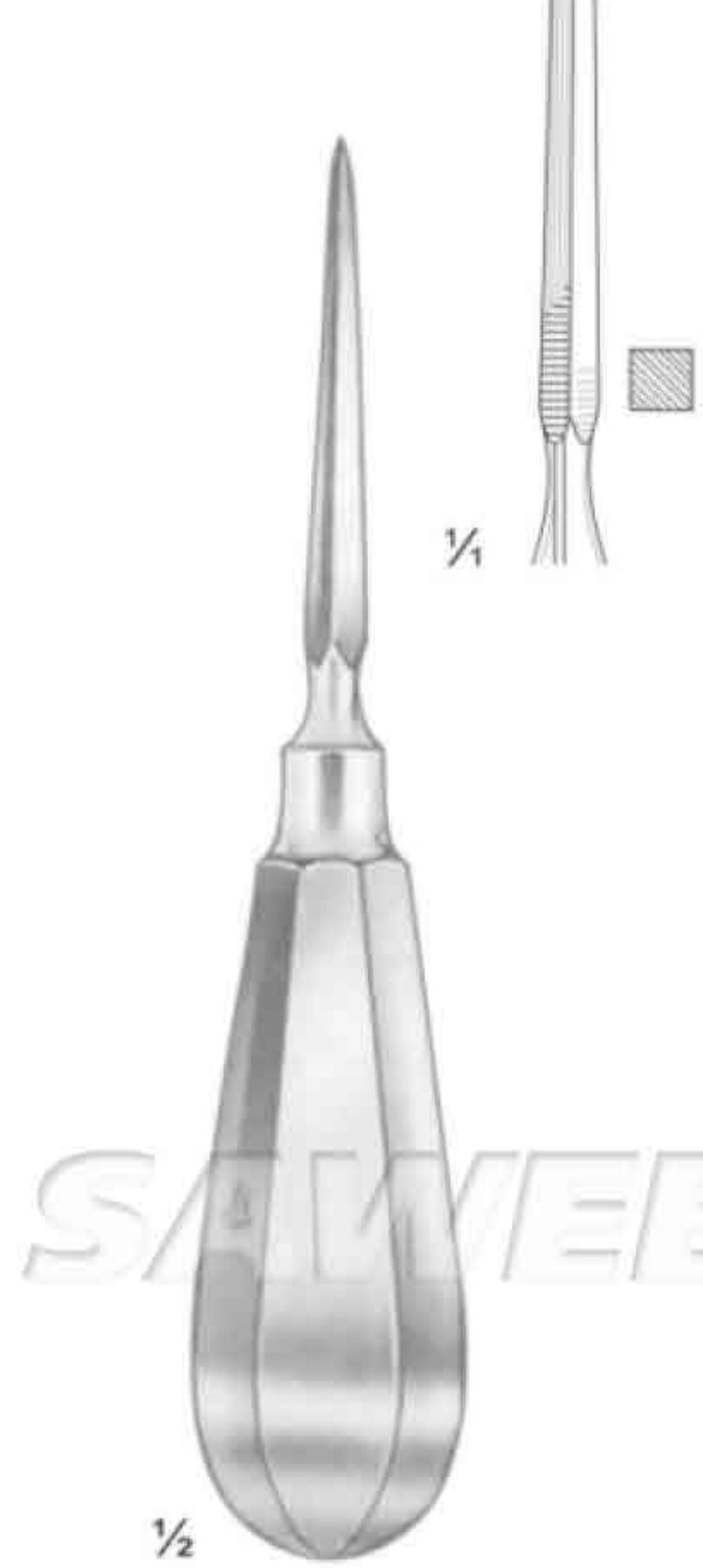
¼

Satterlee
SSC-23-16-91
31.0 cm / 12¼"



SAWEEZ SAWEEZ SAWEEZ SAWEEZ

SAWEEZ SAWEEZ SAWEEZ SAWEEZ



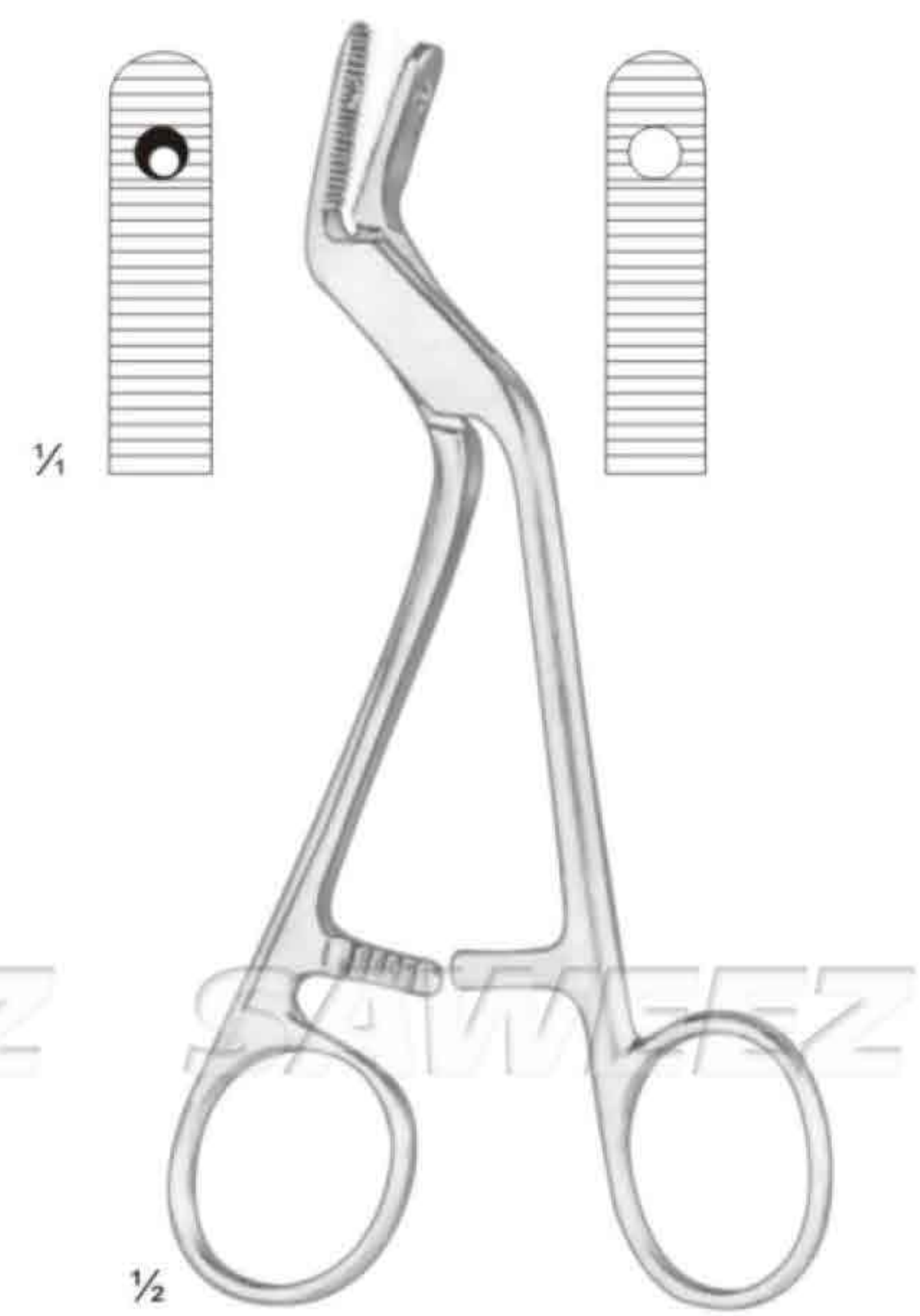
SSC-23-16-92
14.0 cm / 5 1/2"



Perthes
SSC-23-16-93
21.0 cm / 8 1/4"



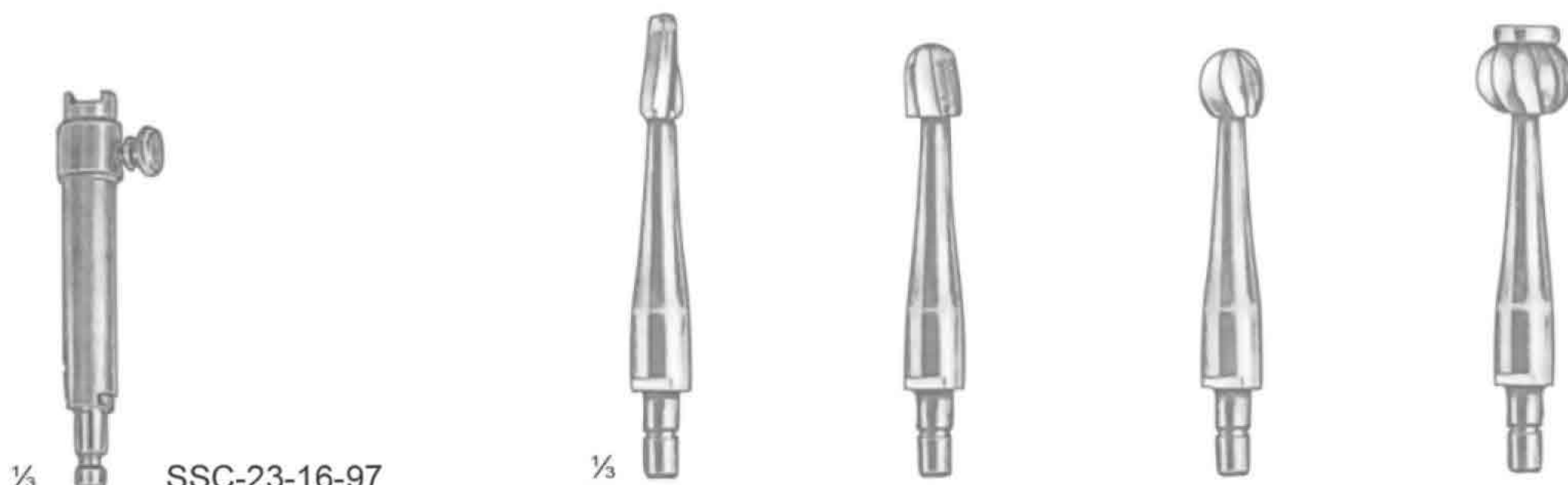
SSC-23-16-94
14.0 cm / 5 1/2"



Adson
SSC-23-16-95
15.0 cm / 6"

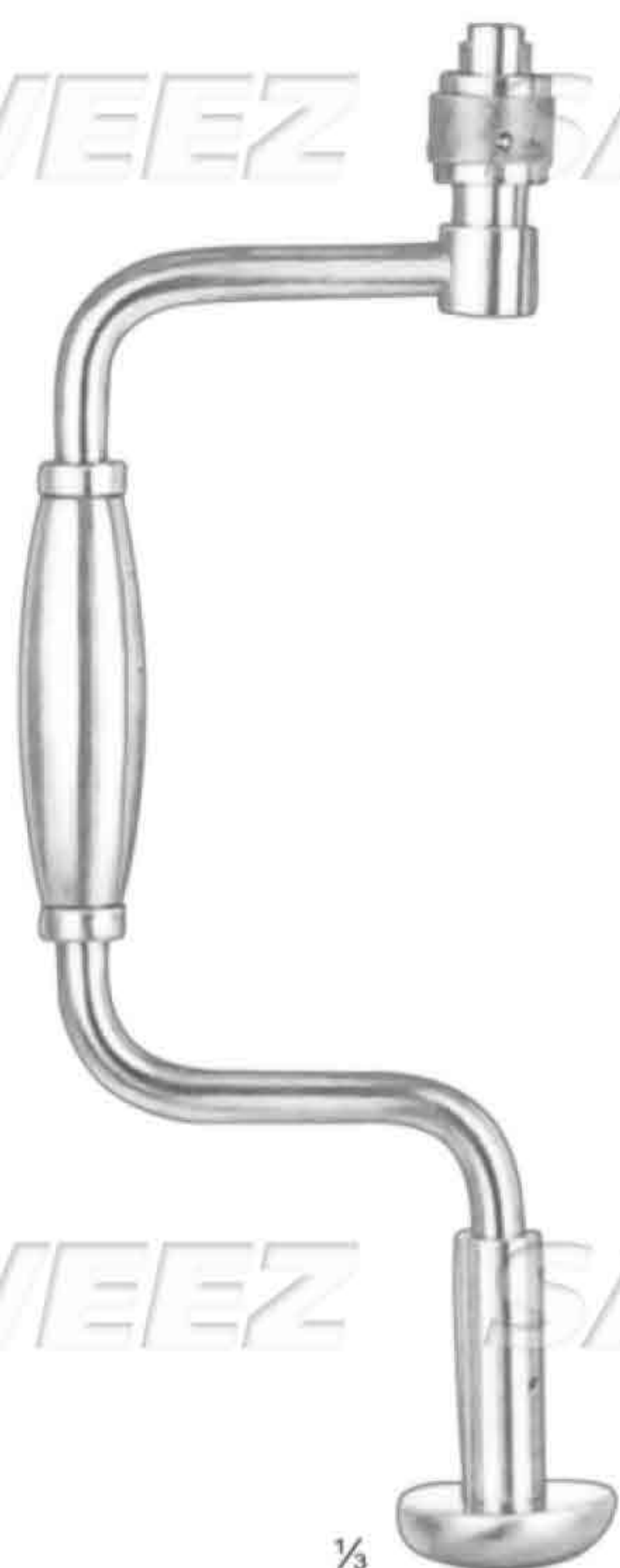


SAWEEZ SAWEEZ SAWEEZ SAWEEZ

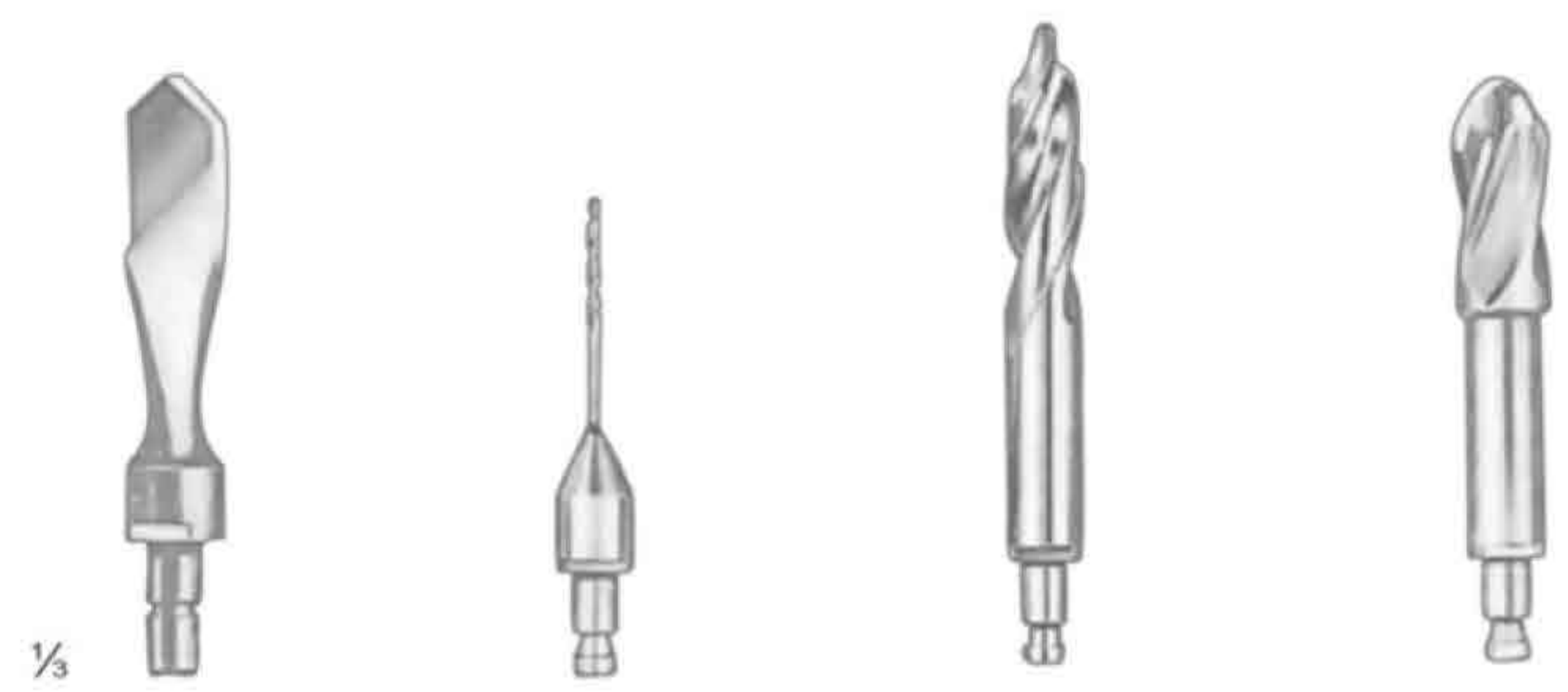


1/8 SSC-23-16-97
1/3 SSC-23-16-98 9 mm ø
SSC-23-16-99 14 mm ø
SSC-23-17-00 16 mm ø
SSC-23-17-01 22 mm ø

SAWEEZ SAWEEZ SAWEEZ SAWEEZ



1/3
Hudson
SSC-23-16-96
27.0 cm / 10 1/2"



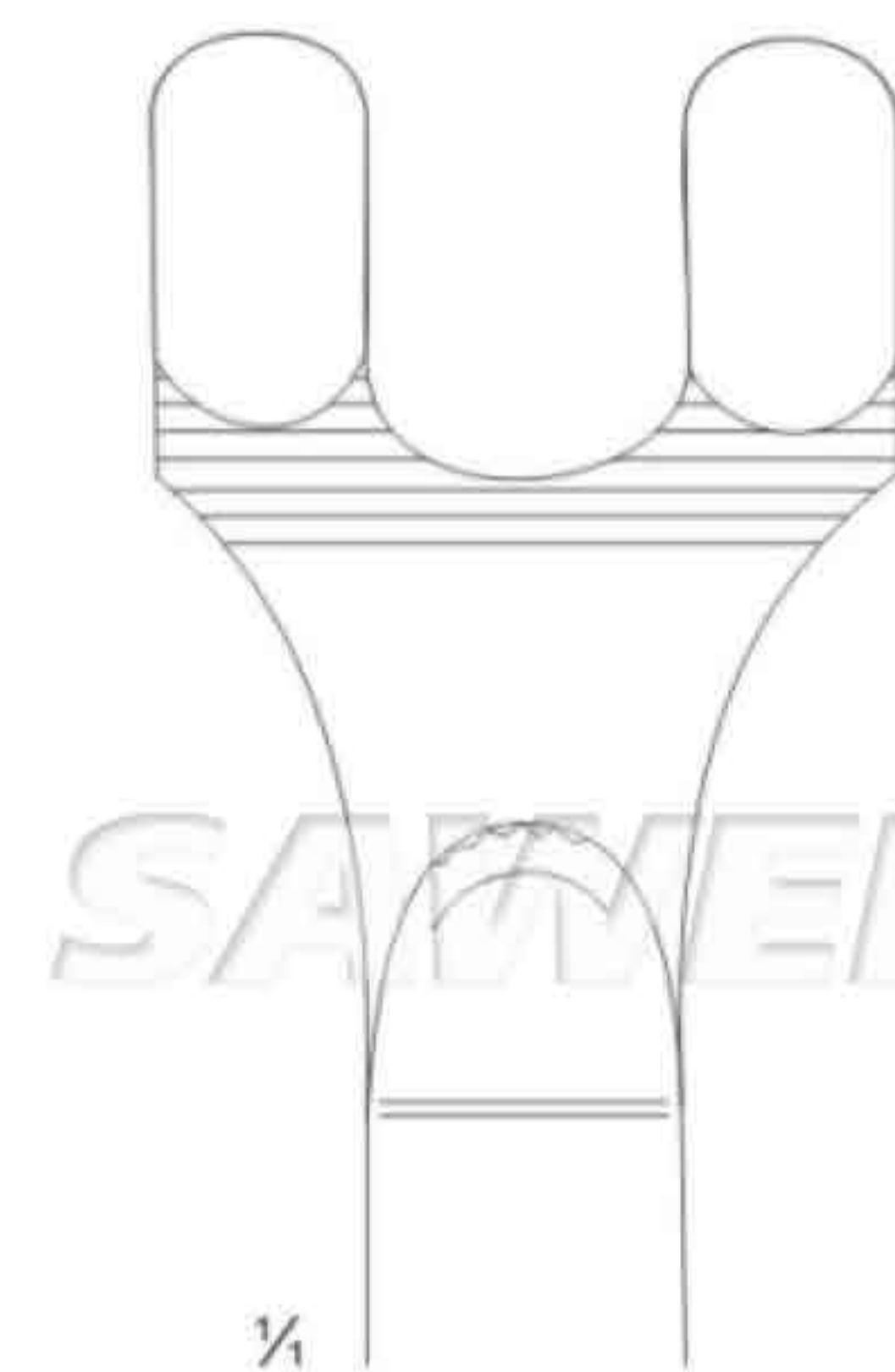
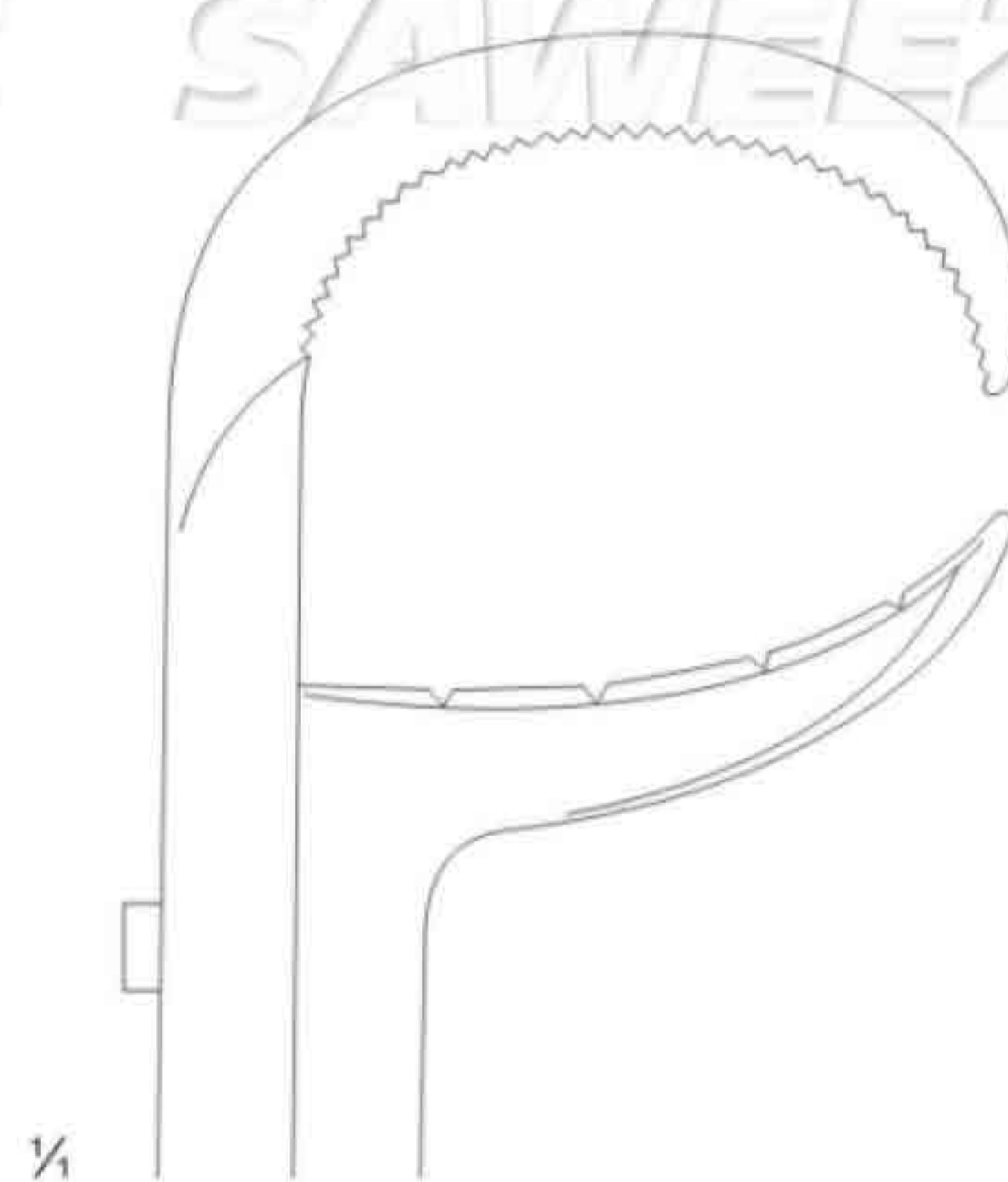
1/3
Cushing SSC-23-17-02 14 mm ø
McKenzie SSC-23-17-04 13 mm ø
Errico SSC-23-17-05 16 mm ø

SAWEEZ SAWEEZ SAWEEZ SAWEEZ

Hand Drill, with 4 burrs fig. 64-67 and extension piece fig.63

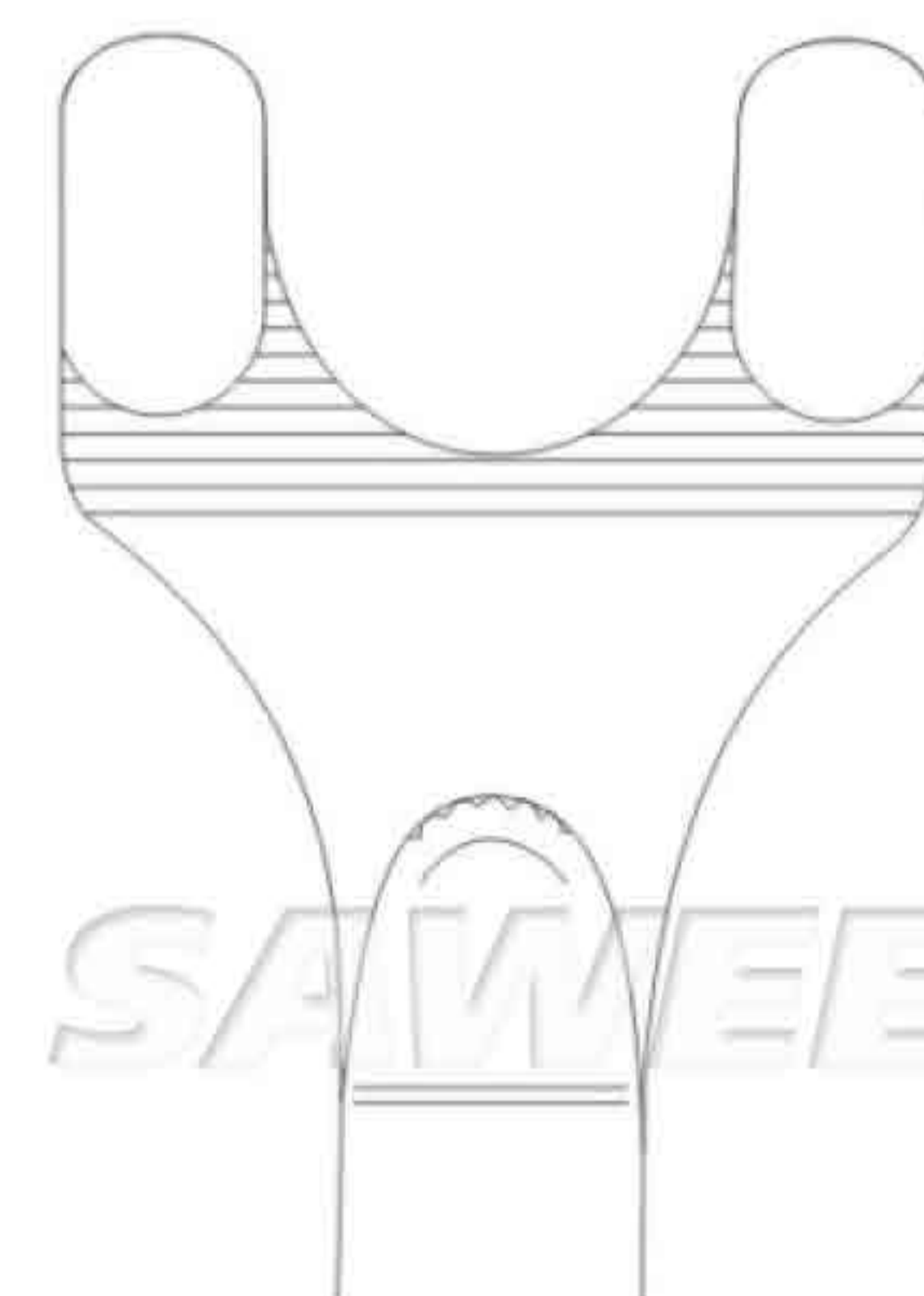


SAWEEZ SAWEEZ SAWEEZ SAWEEZ

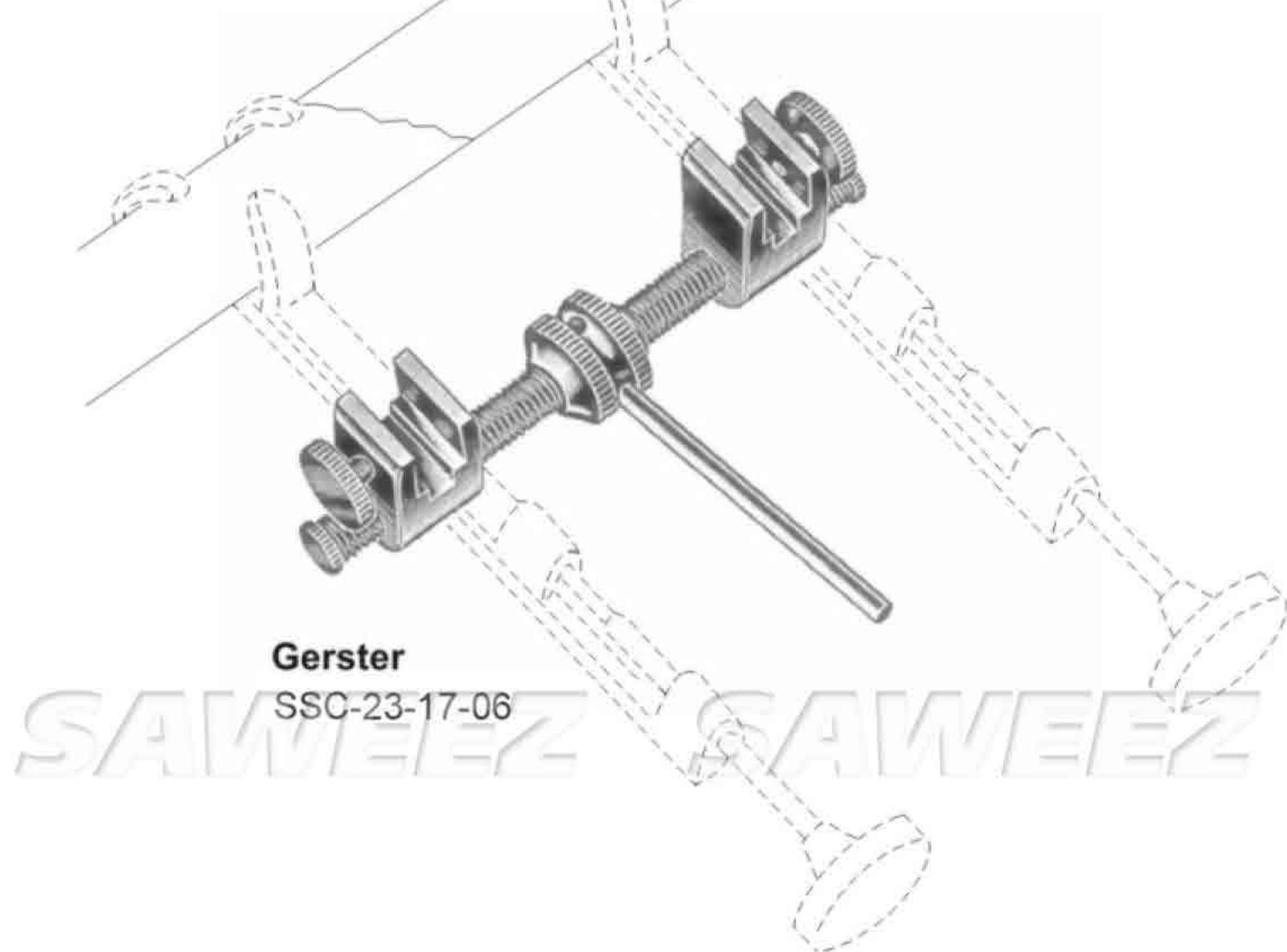


SSC-23-17-07
18.0 cm / 7"

SAWEEZ SAWEEZ SAWEEZ SAWEEZ



SSC-23-17-09
20.0 cm / 8"

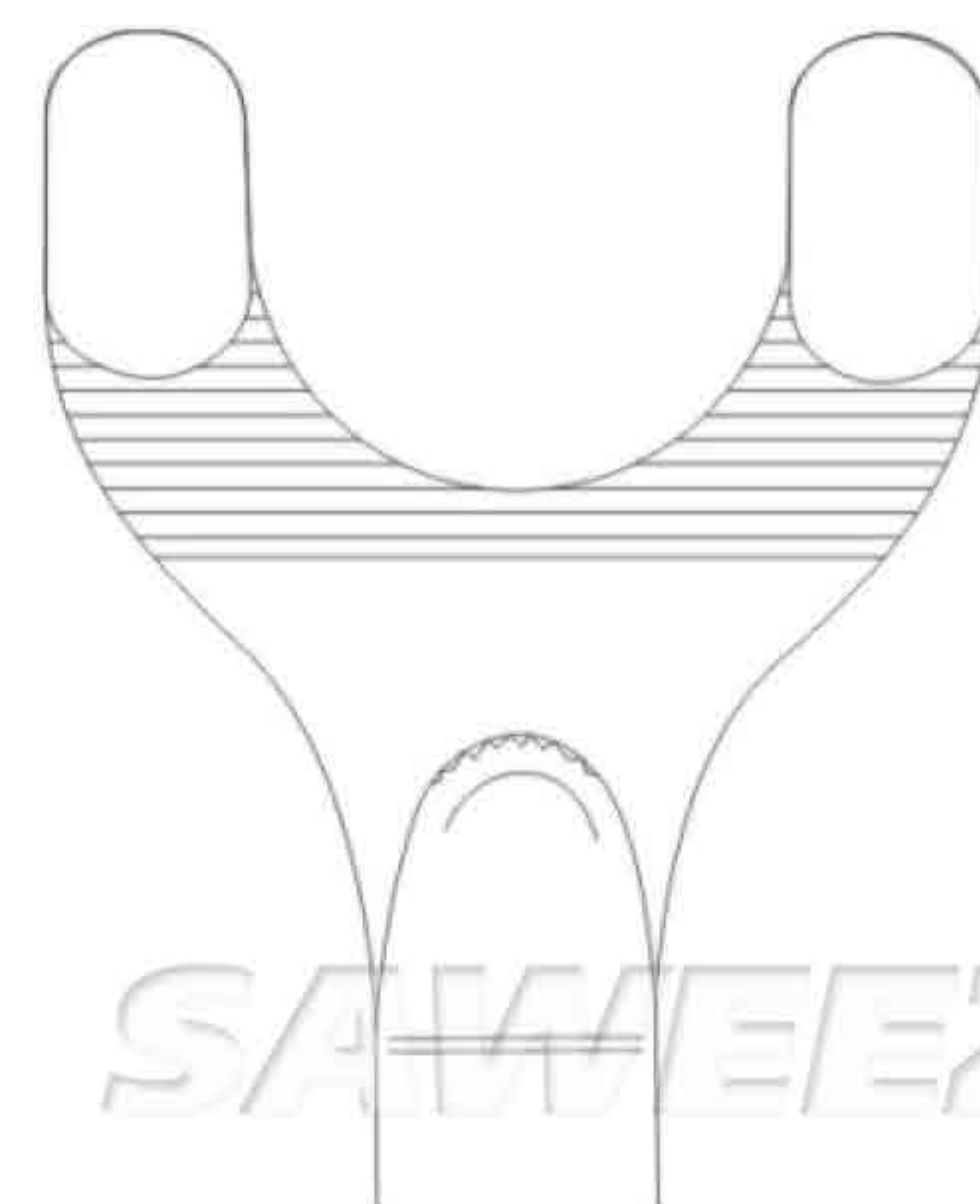


Gerster
SSC-23-17-06

SAWEEZ SAWEEZ SAWEEZ SAWEEZ



Gerster-Lowmann



SSC-23-17-10
22.0 cm / 8 3/4"



SSC-23-17-11
16.5 cm / 6 1/2"



SSC-23-17-12
16.0 cm / 6 1/4"
Heavy Pattern

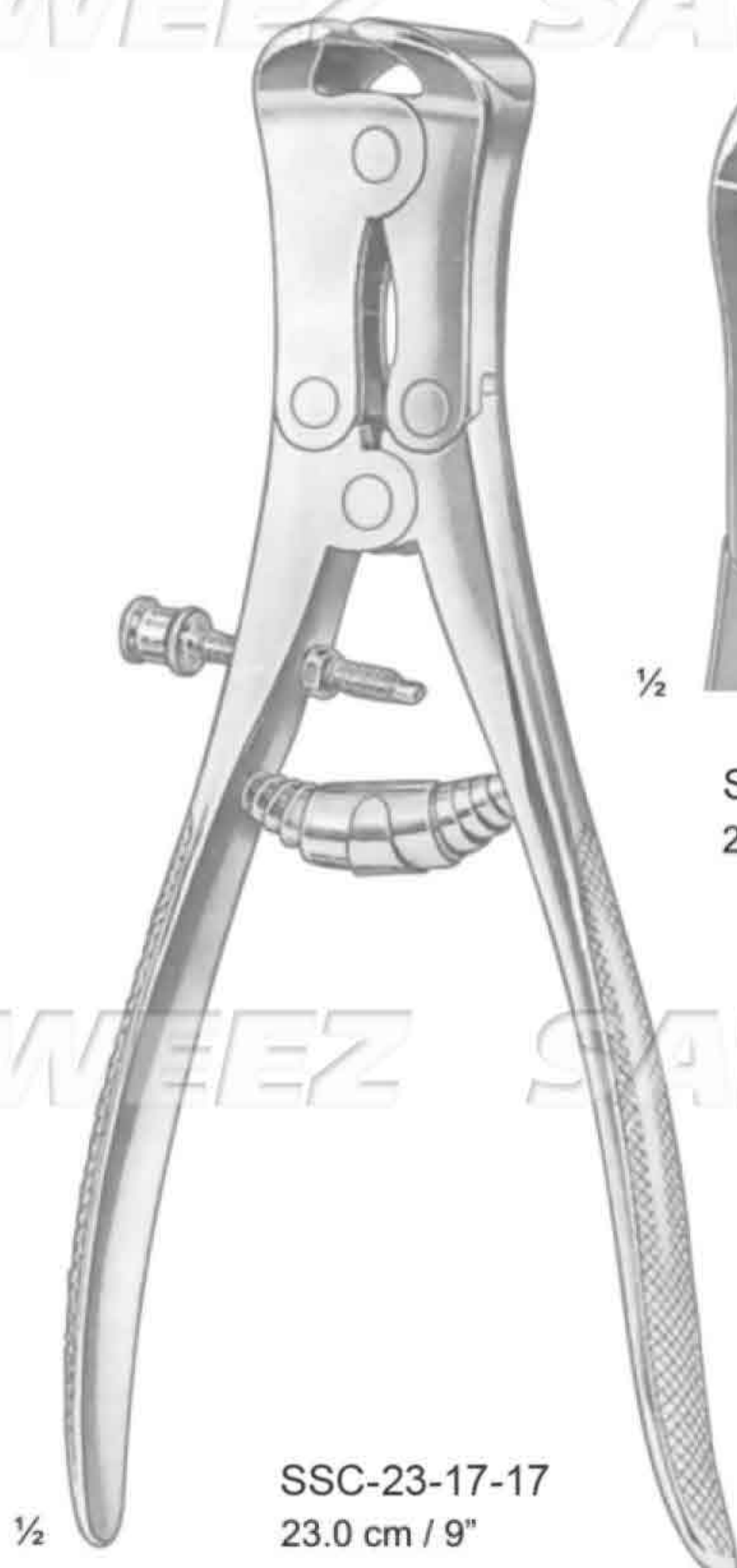


SSC-23-17-13
17.0 cm / 6 1/2"

SAWEEZ SAWEEZ SAWEEZ SAWEEZ



SSC-23-17-14
18.0 cm / 7"



SSC-23-17-17
23.0 cm / 9"
Tungsten Carbide

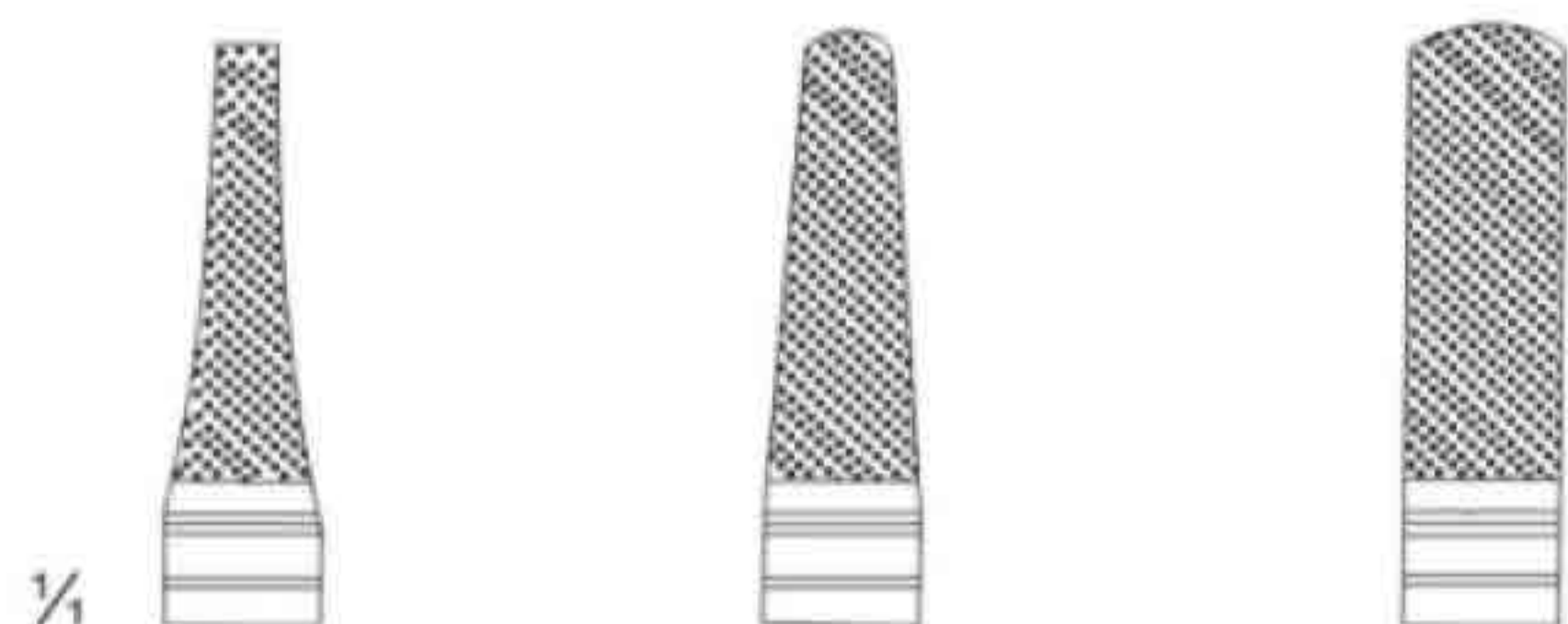


SSC-23-17-15
25.0 cm / 9 3/4"



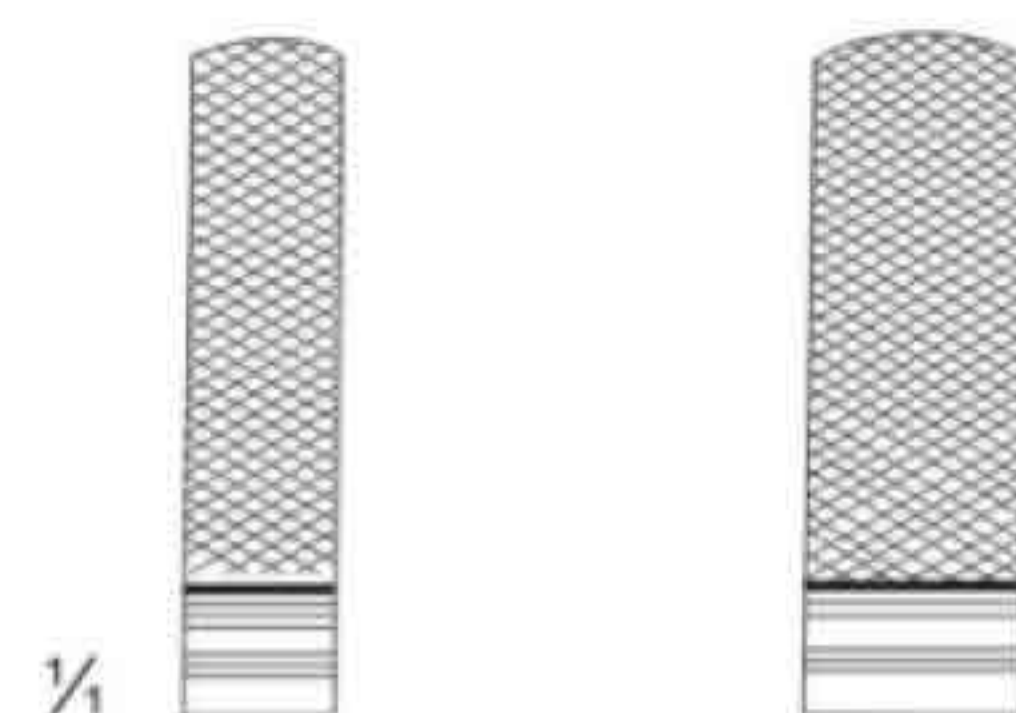
SSC-23-17-16
15.0 cm / 6"

SAWEEZ SAWEEZ SAWEEZ SAWEEZ

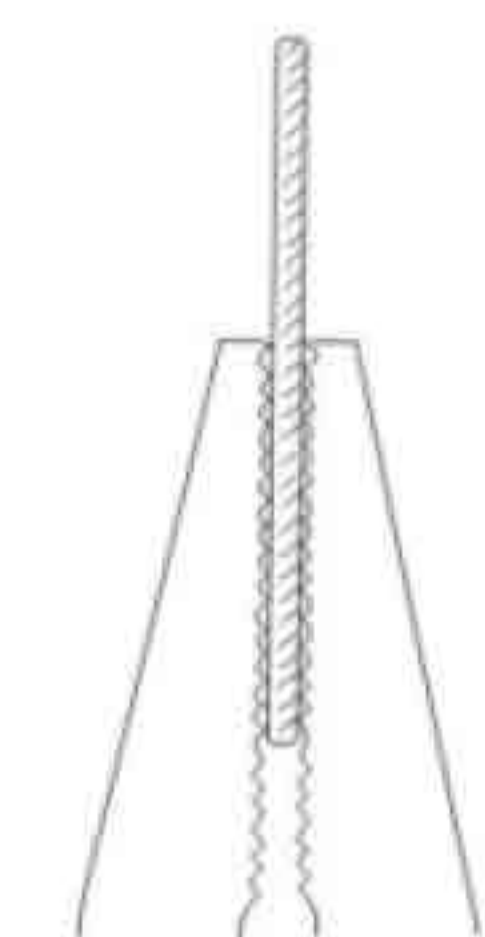


SSC-23-17-18 18.0 cm / 7"
SSC-23-17-19 18.0 cm / 7"
SSC-23-17-20 18.0 cm / 7"

TC GOLD
TUNGSTEN CARBIDE
TC GOLD



SSC-23-17-21 18.0 cm / 7"
SSC-23-17-22 18.0 cm / 7"

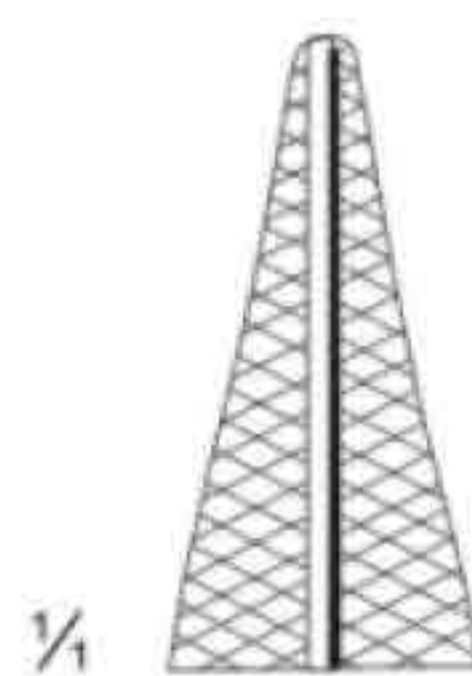


Parallel Action

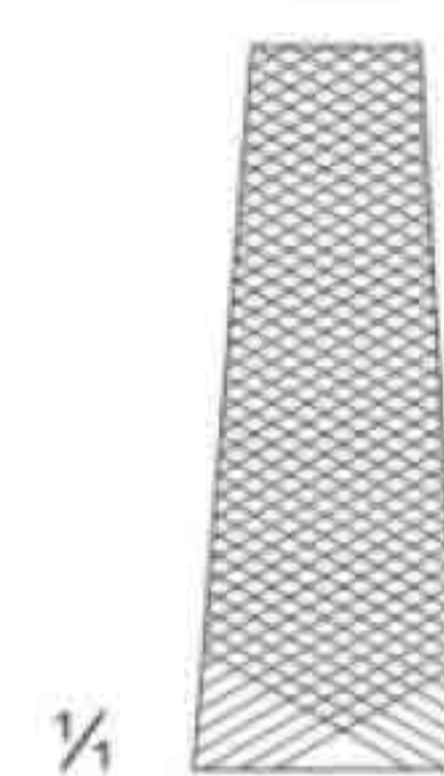
SAWEEZ SAWEEZ SAWEEZ SAWEEZ



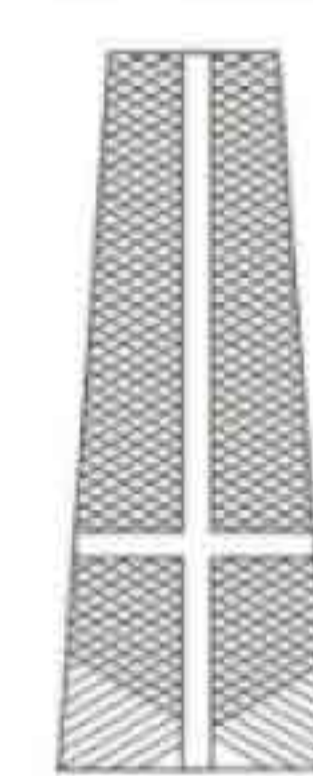
SSC-23-17-23
14.0 cm / 5½"



SSC-23-17-24
16.0 cm / 6¼"
with groove



SSC-23-17-25
17.0 cm / 6¾"



SSC-23-17-26
17.0 cm / 6¾"

SAWEEZ SAWEEZ SAWEEZ SAWEEZ



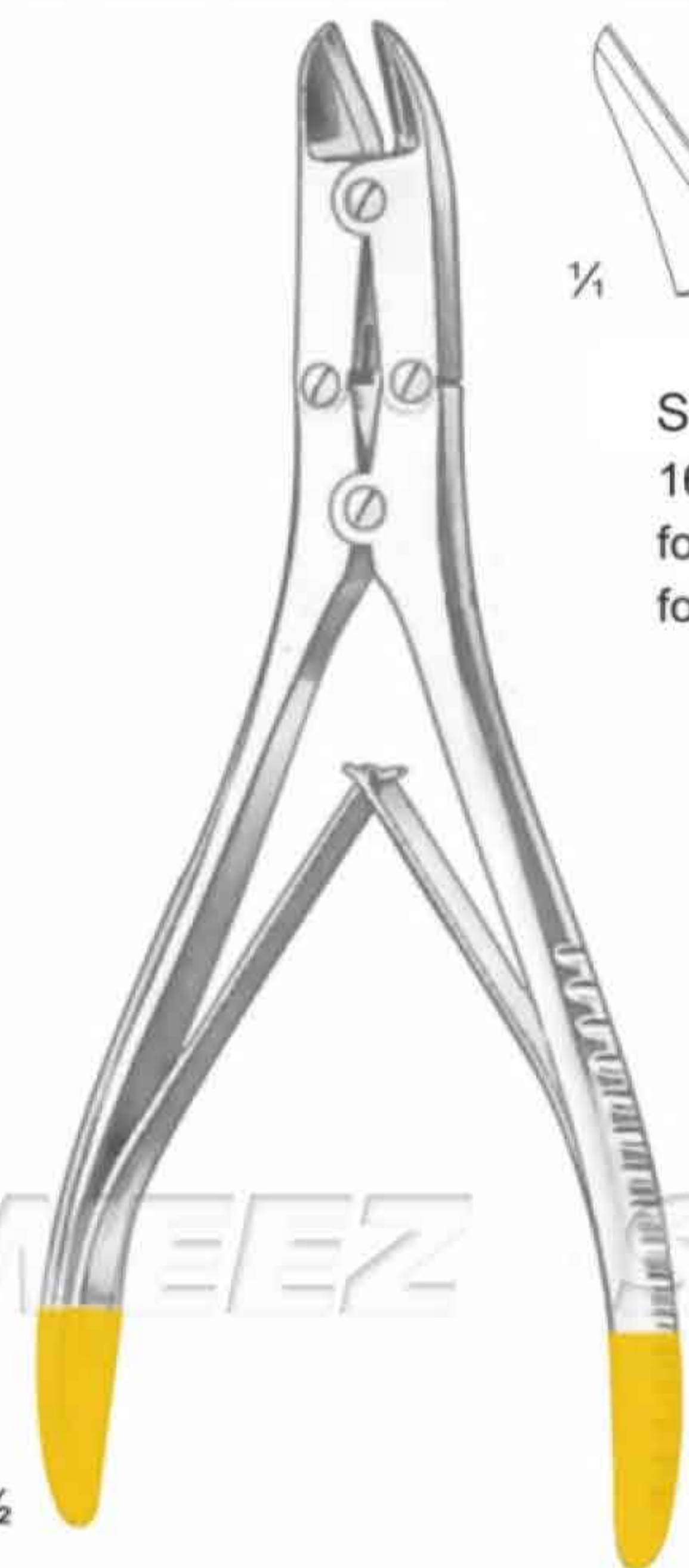
TC / GOLD



SSC-23-17-27
16.0 cm / 6 1/4"



Diamant
SSC-23-17-28
16.0 cm / 6 1/4"



SSC-23-17-29
16.0 cm / 6 1/4"
for hard wires up to 1.6 mm ø
for soft wires up to 2.0 mm ø



SSC-23-17-30
22.0 cm / 8 3/4"
for wires up to 2.5 mm ø



TC GOLD

SAWEEZ SAWEEZ SAWEEZ SAWEEZ

SAWEEZ SAWEEZ SAWEEZ SAWEEZ

SAWEEZ SAWEEZ SAWEEZ SAWEEZ



1/2

SSC-23-17-31
15.0 cm / 6"



1/2

SSC-23-17-32
24.0 cm / 9 1/2"



1/2

SSC-23-17-33
18.0 cm / 7"



for soft wires
up to 2 mm ø

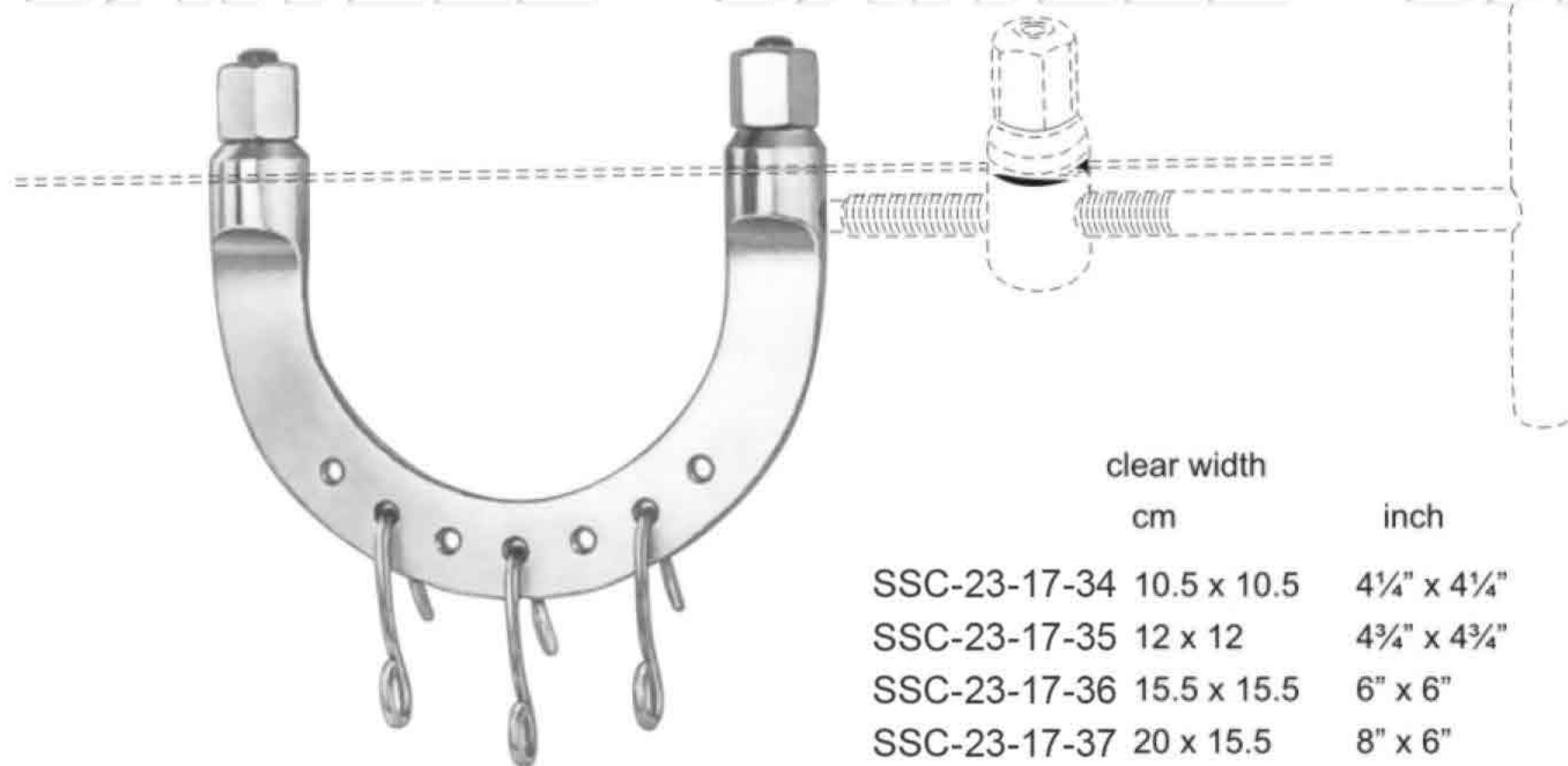


for soft wires
up to 1.5 mm ø



with 3 traction hooks

SAWEEZ SAWEEZ SAWEEZ SAWEEZ



clear width
cm inch

SSC-23-17-34	10.5 x 10.5	4¼" x 4¼"
SSC-23-17-35	12 x 12	4¾" x 4¾"
SSC-23-17-36	15.5 x 15.5	6" x 6"
SSC-23-17-37	20 x 15.5	8" x 6"

Kirschner

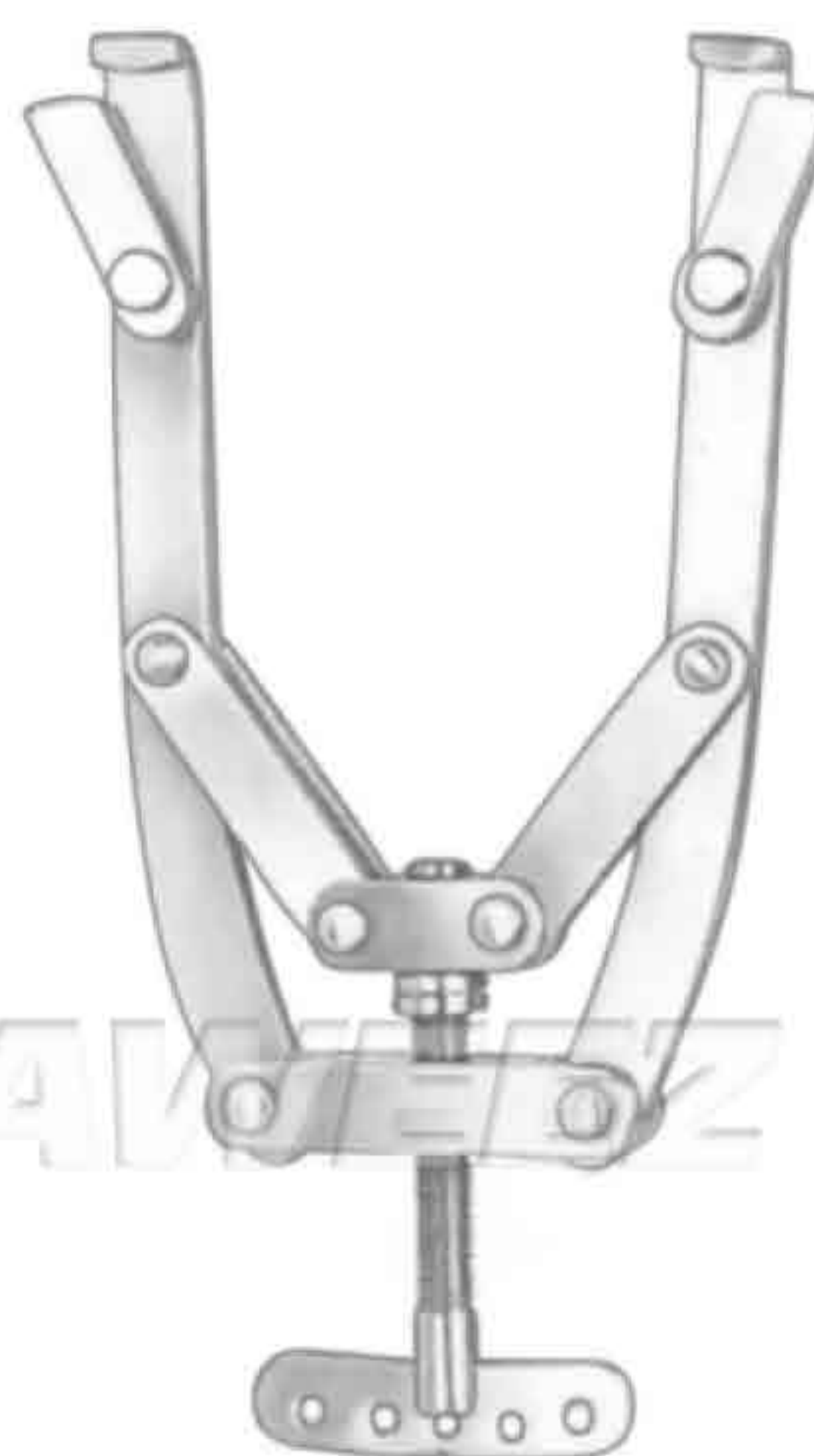
SAWEEZ SAWEEZ SAWEEZ SAWEEZ

with 3 traction hooks

with 3 traction hooks



Kirschner
SSC-23-17-38
6x6 cm / 2½"x2"



SSC-23-17-39
18.0 cm / 7¼"
0-4 mm

SSC-23-17-40
27.0 cm / 10½"
35-200 mm

Kirschner

SAWEEZ SAWEEZ SAWEEZ SAWEEZ



SSC-23-17-41



SSC-23-17-42
19.0 cm / 7½"



	clear width cm	in
SSC-23-17-43	18 x 10	7" x 4"
SSC-23-17-44	27 x 27	10½" x 6¼"

Wire gauze, sterilizable

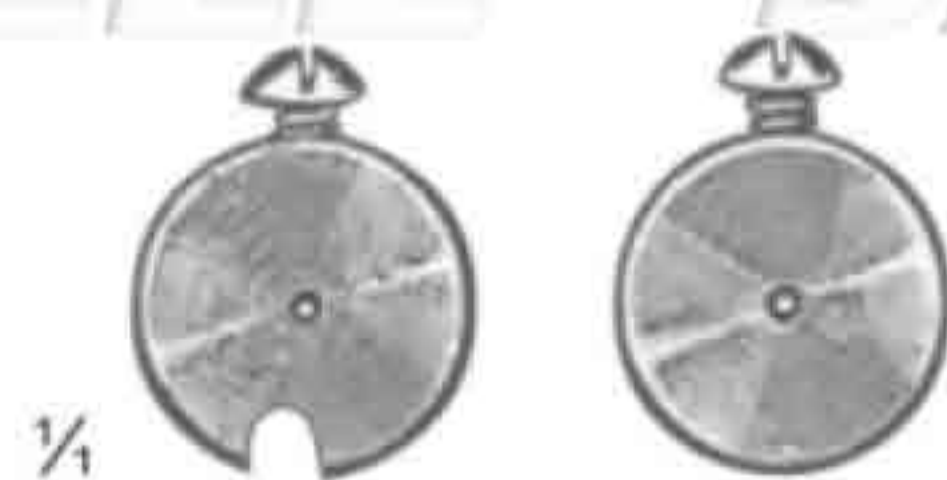


SSC-23-17-45
Small

SSC-23-17-46
Medium

SSC-23-17-47
Large

Fixation Disks for wire drills



SSC-23-17-48
Pair
Wire Strainer for Kirschner extension bows

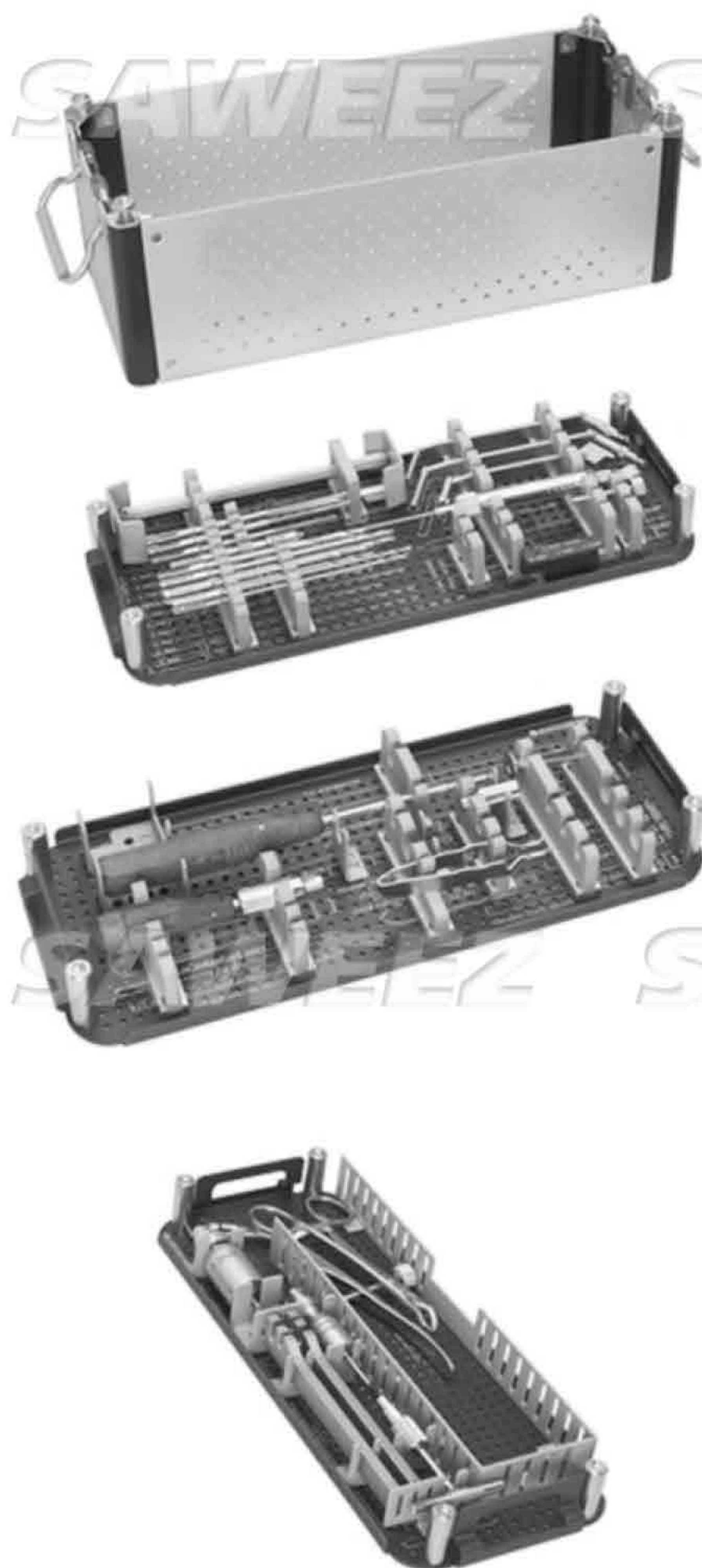


SSC-23-17-49



SSC-23-17-50

Screw Nut Wrench for



Small Fragment Set

Large Fragment Set

ART NO	#	PRODUCT NAME	ART NO	#	PRODUCT NAME
SSC-23-17-51	01	2.0mm Drill Bit,quick coupling,125mm,2ea.	SSC-23-17-76	01	3.2mm Drill Bit,quick Coupling,195mm
SSC-23-17-52	02	2.5mm Drill Bit,quick coupling,110mm,2ea.	SSC-23-17-77	02	4.0mm Drill Bit,quick Coupling,197mm
SSC-23-17-53	03	2.7mm Drill Bit,quick coupling,100mm,2ea.	SSC-23-17-78	03	4.5mm Drill Bit,quick Coupling,145mm
SSC-23-17-54	04	3.5mm Drill Bit,quick coupling,110mm,2ea.	SSC-23-17-79	04	5.5mm Drill Bit,quick Coupling,197mm
SSC-23-17-55	05	Countersink,for 3.5mm Cortex and 4.0mm Cancellous Bone Screws	SSC-23-17-80	05	Countersink,for 4.5mm Cortex and Screws
SSC-23-17-56	06	Tap for 2.7mm Cortex Screws	SSC-23-17-81	06	T-Handle with quick Coupling
SSC-23-17-57	07	Tap for 3.5mm Cortex Screws	SSC-23-17-82	07	Tap for 4.5mm Cortex and 4.5mm Shaft Screws, 180mm/110mm tap depth
SSC-23-17-58	08	Tap for 4.0mm Cancellous Bone Screws	SSC-23-17-83	08	Tap for 5.5mm Cortex and 197mm/100mm tap depth
SSC-23-17-59	09	Handle,with quick coupling	SSC-23-17-84	09	Tap for 6.5mm Cancellous Screws, 197mm/150mm Calibration
SSC-23-17-60	10	T Handle,with quick coupling	SSC-23-17-85	10	4.5mm/3.2mm Double Drill Sleeve
SSC-23-17-61	11	2.0mm Parallel Drill Guide and Drill Sleeve	SSC-23-17-86	11	5.5mm/4.0mm Double Drill Sleeve
SSC-23-17-62	12	3.5mm/2.5mm Insert Drill Sleeve	SSC-23-17-87	12	Holding Sleeve
SSC-23-17-63	13	Small Hexagonal Screwdriver with Holding Sleeve	SSC-23-17-88	13	Large Hexagonal Screwdriver Shaft
SSC-23-17-64	14	Small Hexagonal Screwdriver Shaft	SSC-23-17-89	14	Large Hexagonal Screwdriver
SSC-23-17-65	15	Depth Guage for 2.7mm and 3.5mm cortex, and 4.0mm Cancellous Bone Screws	SSC-23-17-90	15	Depth Gauge, for large Screws
SSC-23-17-67	16	Screw Forceps	SSC-23-17-91	16	Articulated Tension Device
SSC-23-17-68	17	2.7mm Universal Drill Guide	SSC-23-17-92	17	Ratchet Wrench, 11mm Width across flats
SSC-23-17-69	18	3.5mm Universal Drill Guide	SSC-23-17-93	18	5.5mm Universal Drill Guide
SSC-23-17-70	19	Bending Iron for 2.7mm and 3.5mm Plates	SSC-23-17-94	19	4.5mm Universal Drill Guide
SSC-23-17-71	20	Bending Iron for 2.7mm and 3.5mm Plates	SSC-23-17-95	20	3.2mm Drill Bit,quick Coupling, 145mm
SSC-23-17-72	21	1.25mm Kirschner Wire,150mm,trocar point (10/pkg.)	SSC-23-17-96	21	4.5mm Drill Bit,quick Coupling, 145mm
SSC-23-17-73	22	2.0mm Kirschner Wire,150mm,trocar point (10/pkg.)			
SSC-23-17-74	23	2.7mm DCP Drill Guide,neutral and load			
SSC-23-17-75	24	3.5mm DCP Drill Guide,neutral and load			

SAWEEZ SAWEEZ SAWEEZ SAWEEZ

**Osteotome(Straight)**

- SSC-23-17-96 = 6 (Blade width) 240 mm (Length)
- SSC-23-17-97 = 8 (Blade width) 240 mm (Length)
- SSC-23-17-98 = 10 (Blade width) 240 mm (Length)
- SSC-23-17-99 = 12 (Blade width) 240 mm (Length)
- SSC-23-18-00 = 15 (Blade width) 240 mm (Length)
- SSC-23-18-01 = 20 (Blade width) 240 mm (Length)
- SSC-23-18-02 = 25 (Blade width) 240 mm (Length)
- SSC-23-18-03 = 30 mm (Blade width) 240 mm (Length)

**Bone Hammer**

- SSC-23-18-28 = 50 (Weight)
- SSC-23-18-29 = 140 (Weight)
- SSC-23-18-30 = 270 (Weight)
- SSC-23-18-31 = 350 (Weight)
- SSC-23-18-32 = 450g (Weight)

**Osteotome(Curved)**

- SSC-23-18-04 = 6 (Blade width) 240 mm (Length)
- SSC-23-18-05 = 8 (Blade width) 240 mm (Length)
- SSC-23-18-06 = 10 (Blade width) 240 mm (Length)
- SSC-23-18-07 = 12 (Blade width) 240 mm (Length)
- SSC-23-18-08 = 15 (Blade width) 240 mm (Length)
- SSC-23-18-09 = 20 (Blade width) 240 mm (Length)
- SSC-23-18-10 = 25 (Blade width) 240 mm (Length)
- SSC-23-18-11 = 30 mm (Blade width) 240 mm (Length)

**Periosteal Elevator**

- SSC-23-18-33 = 9 (Blade width) 180 mm (Length)
- SSC-23-18-34 = 12 (Blade width) 180 mm (Length)
- SSC-23-18-35 = 15 (Blade width) 180 mm (Length)
- SSC-23-18-36 = 10 (Blade width) 240 mm (Length)
- SSC-23-18-37 = 15 (Blade width) 240 mm (Length)
- SSC-23-18-38 = 20 (Blade width) 240 mm (Length)

**Double-Sided Osteotome**

- SSC-23-18-12 = 6 (Blade width) 300 mm (Length)
- SSC-23-18-13 = 8 (Blade width) 300 mm (Length)
- SSC-23-18-14 = 10 (Blade width) 300 mm (Length)
- SSC-23-18-15 = 12 (Blade width) 300 mm (Length)
- SSC-23-18-16 = 15 (Blade width) 300 mm (Length)
- SSC-23-18-17 = 20 (Blade width) 300 mm (Length)
- SSC-23-18-18 = 25 (Blade width) 300 mm (Length)
- SSC-23-18-19 = 30 mm (Blade width) 300 mm (Length)

**Bending Spanner**

- SSC-23-18-39 = 240 mm (Length)

**Bone Flat Chisels**

- SSC-23-18-20 = 6 (Blade width) 200 mm (Length)
- SSC-23-18-21 = 9 (Blade width) 200 mm (Length)
- SSC-23-18-22 = 12 mm (Blade width) 200 mm (Length)

**Spinal Gouges**

- SSC-23-18-23 = 3 (Blade width) 200 mm (Length)
- SSC-23-18-24 = 4 (Blade width) 200 mm (Length)
- SSC-23-18-25 = 6 (Blade width) 200 mm (Length)
- SSC-23-18-26 = 8 (Blade width) 200 mm (Length)
- SSC-23-18-27 = 12 mm (Blade width) 200 mm (Length)

**Double-use Guide Drill**

- SSC-23-18-40 = 2.5 mm (Drill Bit Diam)
- SSC-23-18-41 = 3.2 mm (Drill Bit Diam)
- Neutral & Load Bearing Type

**Depth Gauges**

SSC-23-18-42= 30 (Gaugin Depth)

SSC-23-18-43= 60 (Gaugin Depth)

SSC-23-18-44= 90 (Gaugin Depth)

SSC-23-18-45= 100 mm (Gaugin Depth)

**Tap(T-type handle)**

SSC-23-18-54 = HA2.0mm (Diam) 160 mm (Length)

SSC-23-18-55 = HA3.5mm, HB3.5mm (Diam) 160 mm (Length)

SSC-23-18-56 = Ha4m, HB4mm(Diam) 180 mm (Length)

SSC-23-18-57 = HA4.5mm, HB4,5mm (Diam) 180 mm (Length)

**Countersink Drill**

SSC-23-18-46= 6mm (Reamer Diam) 180mm (Length)

SSC-23-18-47 = 8mm (Reamer Diam) 180mm (Length)

**Tap(T-type handle)**

SSC-23-18-58 = HB6.5mm (Diam) 200mm (Length)

**Double-End Guider**

SSC-23-18-48= (ø2.5, ø3.0) Size

SSC-23-18-49= (ø3.2, ø4.5) Size

SSC-23-18-50= (ø4.5, ø6.5) Size

**Bone Pry**

SSC-23-18-59 = 230mm (Length)

Size: 10mm

**Broken Nail Hollow Saw**

SSC-23-18-51 = 8 mm (Inner Diam) 160 mm (Length)

SSC-23-18-52 = 7 mm (Inner Diam) 160 mm (Length)

SSC-23-18-53 = 6 mm (Inner Diam) 160 mm (Length)

**Bone Curette**

SSC-23-18-60 = 3 (Blade Width)

SSC-23-18-61 = 4 (Blade Width)

SSC-23-18-62 = 5 (Blade Width)

SSC-23-18-63 = 6 (Blade Width)

SSC-23-18-64 = 7mm (Blade Width)

Straight, left bend, right bend, front bend



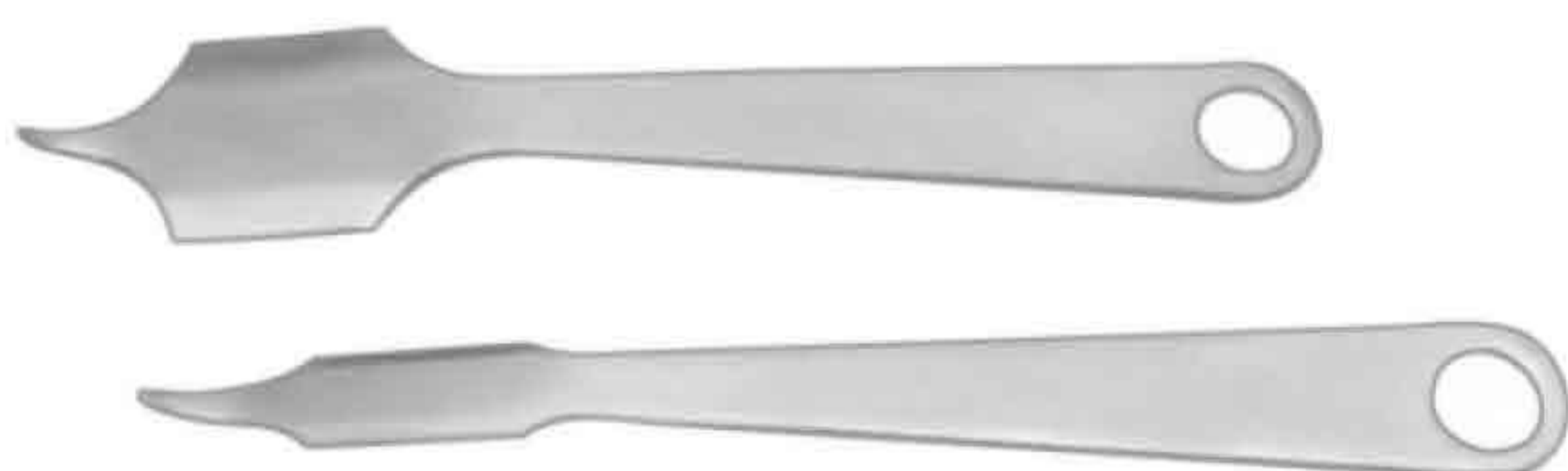
Nerve Detacher

SSC-23-18-65= 3 (Duble Ended width) 240mm (Length)
 SSC-23-18-66= 5mm (Duble Ended width) 240mm (Length)
 SSC-23-18-67= 5mm (Disseetor width)
 with Blant Hook on the other, Length 240mm



Screw Driver

Slotted Point Large, Small
 SSC-23-18-72= SW3.5 (Inner Hexagonal) 200mm (Length)
 SSC-23-18-73= SW2.5 (Inner Hexagonal) 200mm (Length)



Retractor

SSC-23-18-68= 18mm (Size)
 SSC-23-18-69= 42mm (Size)



Safety Screw Driver

Slotted Point Large, Small
 SSC-23-18-74= SW3.5 (Inner Hexagonal)
 SSC-23-18-75= SW2.5 (Inner Hexagonal)



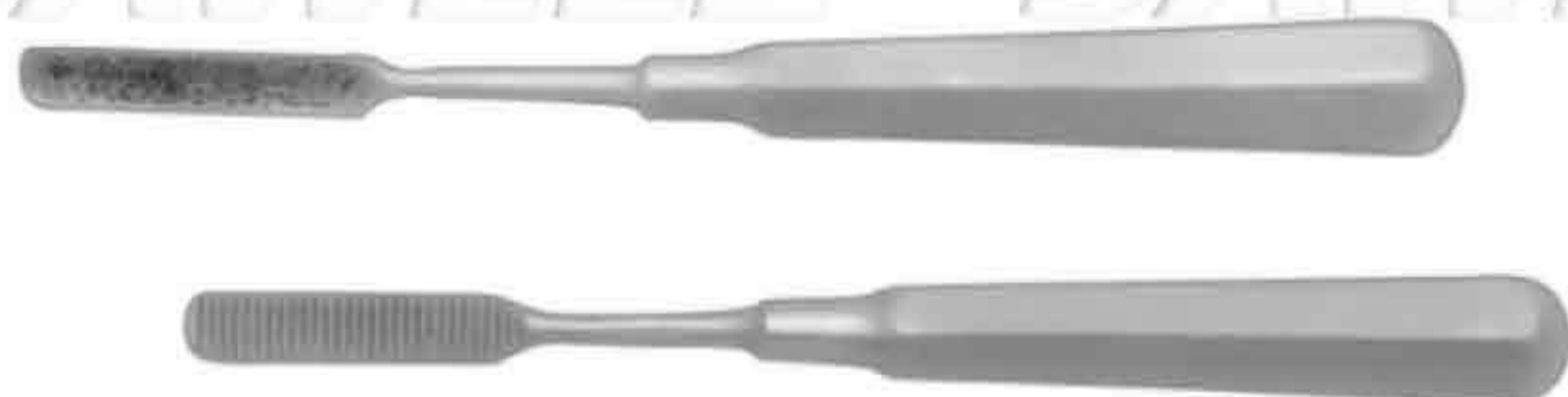
Bone File Osteotribe

SSC-23-18-70
 Round Osteotribe
 Edge Osteotribe



Safety Screwdriver

SSC-23-18-76= (SW2.5ø)
 SSC-23-18-77= (SW3.5ø)
 Size: Flat-head (Small, Large)



Bone File Osteotribe

SSC-23-18-71
 Round Osteotribe
 Flat Osteotribe



Broken Nail Extractor

SSC-23-18-78
 Size: Large, Small



Self-Centering Bone Holding Forceps

SSC-23-18-79 = 180mm (Length)

SSC-23-18-80 = 260mm (Length)

(Large size), (Small size)



Reduction Forceps

SSC-23-18-84 = 160mm (Length)

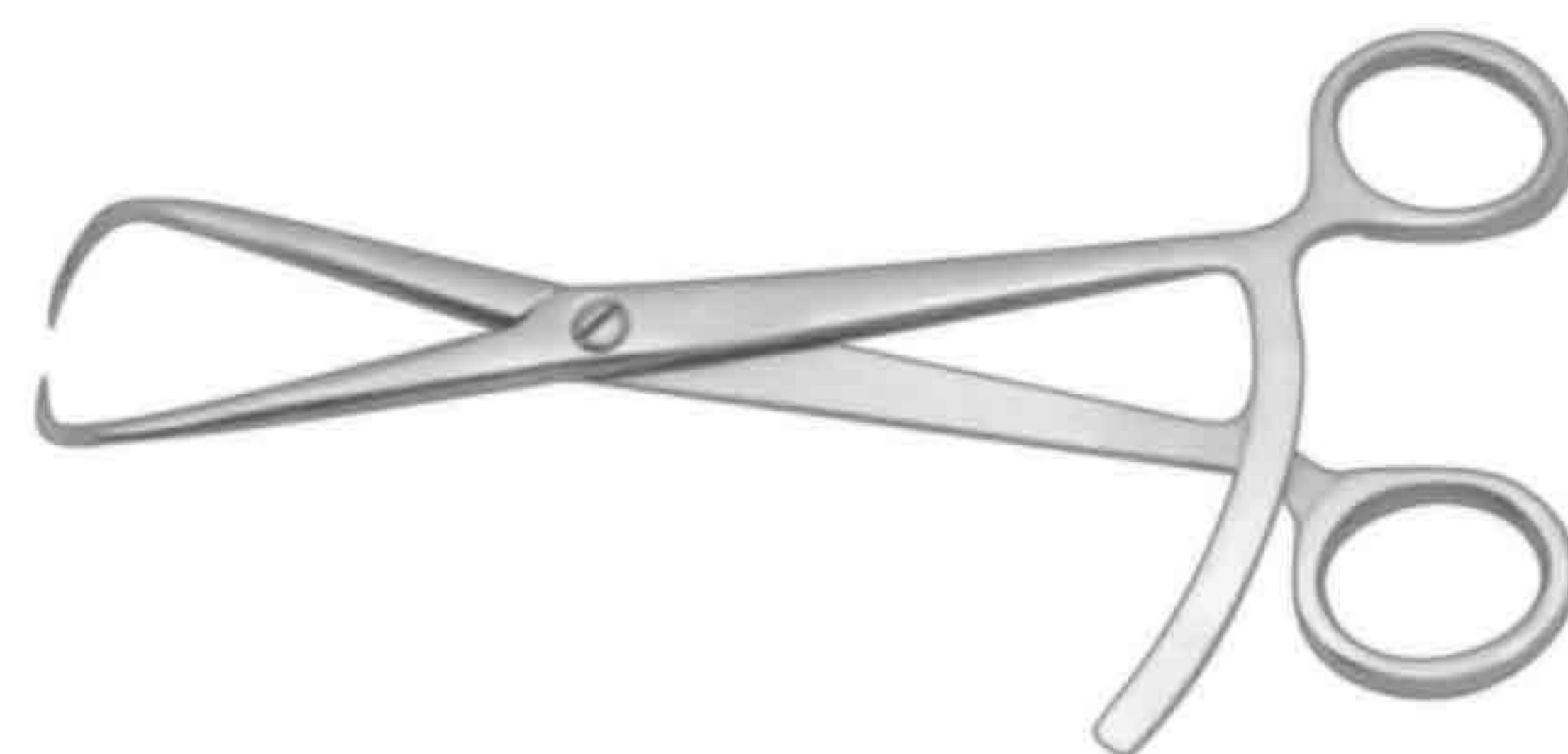
SSC-23-18-85 = 220mm (Length)

Size: Large, small



Triangle Self-Centering Bone Holding Forceps

SSC-23-18-81 = 250mm (Length)



Reduction Forceps with Points

SSC-23-18-86 = 140mm (Length)

SSC-23-18-87 = 200mm (Length)

Size: Large, small



Bone Holding Forceps with Guide

SSC-23-18-82 = 230mm (Length)

Size: Large, medium, small



Double Joint Bone Scissors

(Straight Curved)

SSC-23-18-88 = 160mm (Length)

SSC-23-18-89 = 180mm (Length)

SSC-23-18-90 = 230mm (Length)

SSC-23-18-91 = 270mm (Length)



Bone Holding Clamps

SSC-23-18-83

Size: Large, medium, small

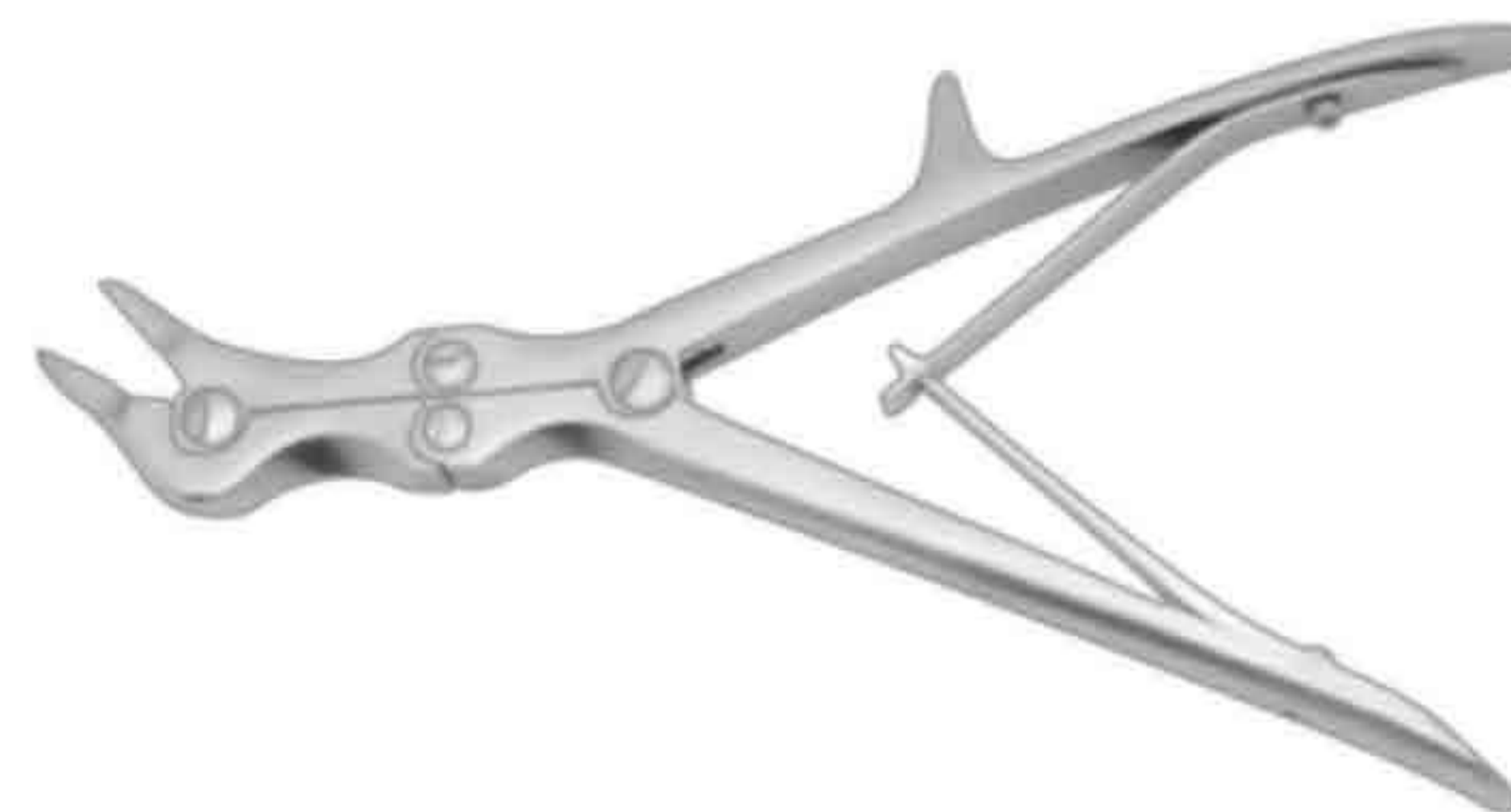


Double Joint Outrigger Scissors

SSC-23-18-92 = 260mm (Length)

**Angle Rongeur Scissors**

SSC-23-18-93 = 200mm (Length)

**Bone Rongeurs (Angular)**

SSC-23-19-02 = 3mm (Blade Width) 220mm (Length)

SSC-23-19-03 = 5mm (Blade Width) 220mm (Length)

SSC-23-19-04 = 6mm (Blade Width) 220mm (Length)

**Double Action Bone Rongeurs (Slightly Curved)**

SSC-23-18-94 = 2-3mm (Blade Width) 160mm (Length)

SSC-23-18-95 = 2-3mm (Blade Width) 180mm (Length)

SSC-23-18-96 = 3-4mm (Blade Width) 220mm (Length)

**Laminectomy Rongeurs (Angular)**

SSC-23-19-05 = 2mm (Blade Width) 160mm (Stem Length)

SSC-23-19-06 = 2.5mm (Blade Width) 160mm (Stem Length)

SSC-23-19-07 = 4.5mm (Blade Width) 160mm (Stem Length)

(Blade Mouth Angle) 90°, 110°, 130°

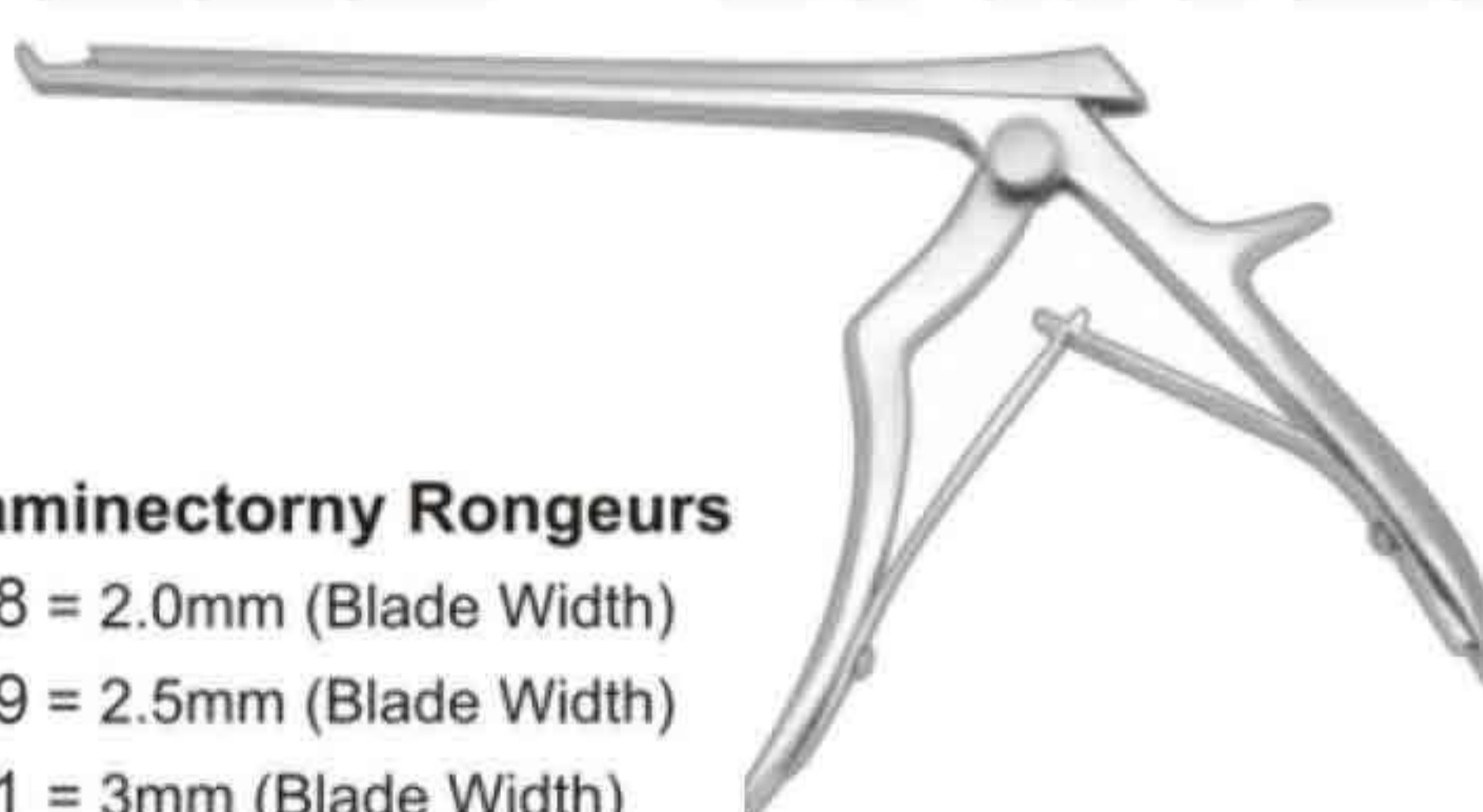
**Double Action Bone Rongeurs (Pointed Curved)**

SSC-23-18-97 = 2mm (Blade Width) 180mm (Length)

SSC-23-18-98 = 3mm (Blade Width) 180mm (Length)

SSC-23-18-99 = 3mm (Blade Width) 220mm (Length)

SSC-23-19-00 = 4mm (Blade Width) 220mm (Length)

**Germanic Laminectomy Rongeurs**

SSC-23-19-08 = 2.0mm (Blade Width)

SSC-23-19-09 = 2.5mm (Blade Width)

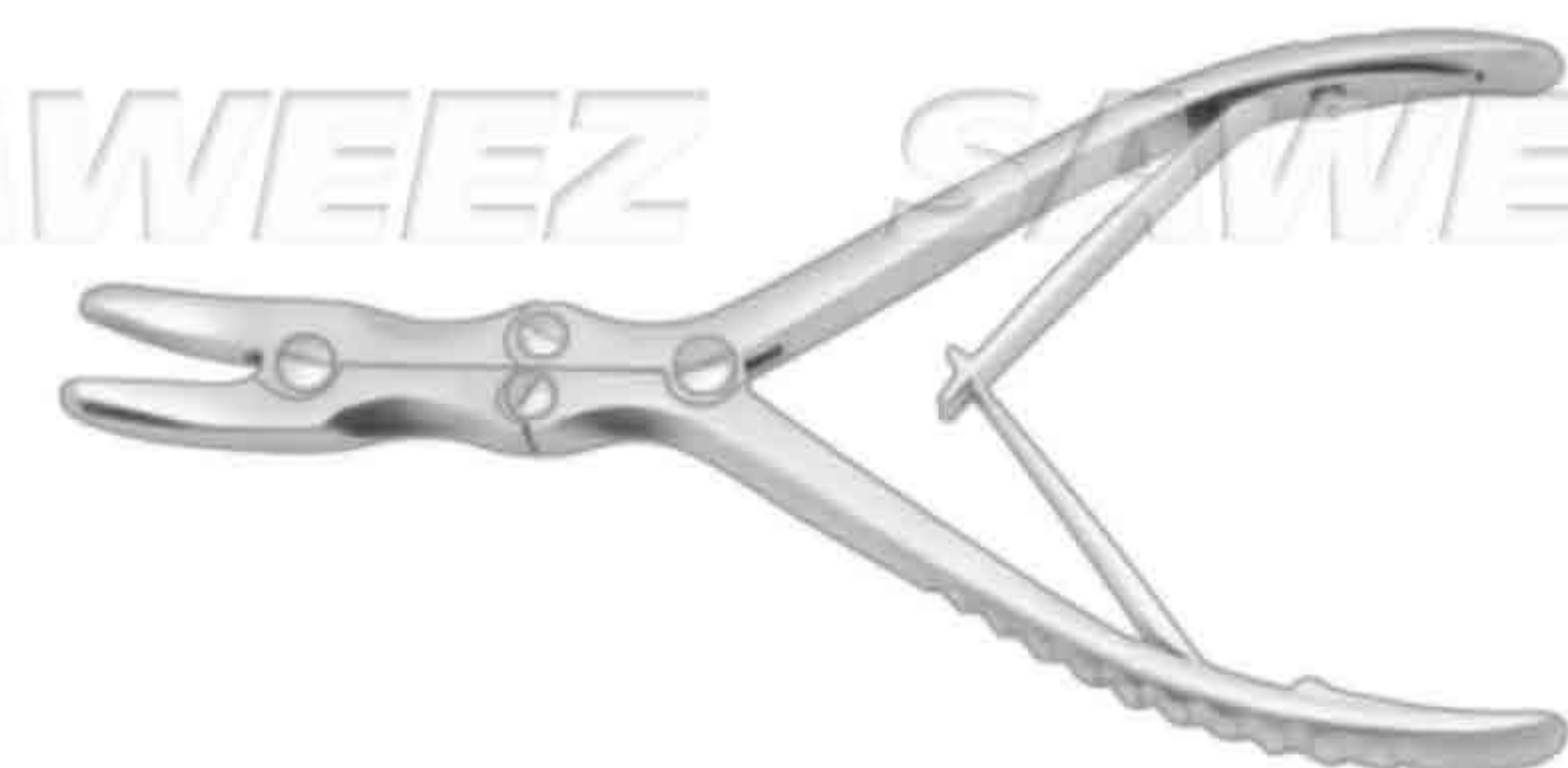
SSC-23-19-11 = 3mm (Blade Width)

SSC-23-19-12 = 3.5mm (Blade Width)

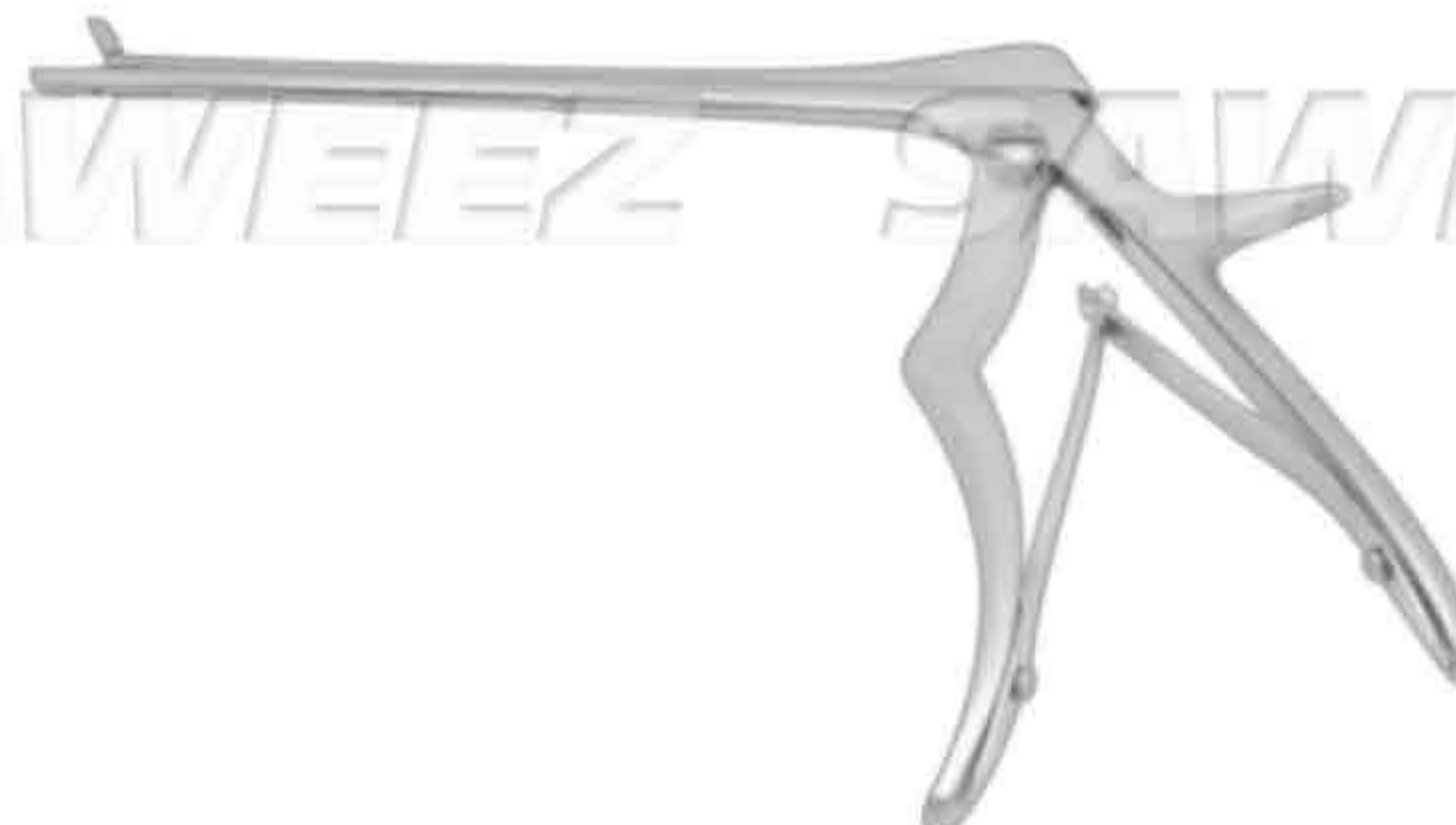
SSC-23-19-13 = 4.5mm (Blade Width)

(Blade Mouth Angle) 90°, 110°, 130°

180mm, 220mm (Stem Length)

**Double Action Bone Rongeurs (Straight)**

SSC-23-19-01 = 8mm (Blade Width) 220mm (Length)

**Spurling Rongeurs (Straight)**

SSC-23-19-14 = 3, 4.5mm (Blade Width) 170mm (Length)

SSC-23-19-15 = 3, 4.5mm (Blade Width) 220mm (Length)

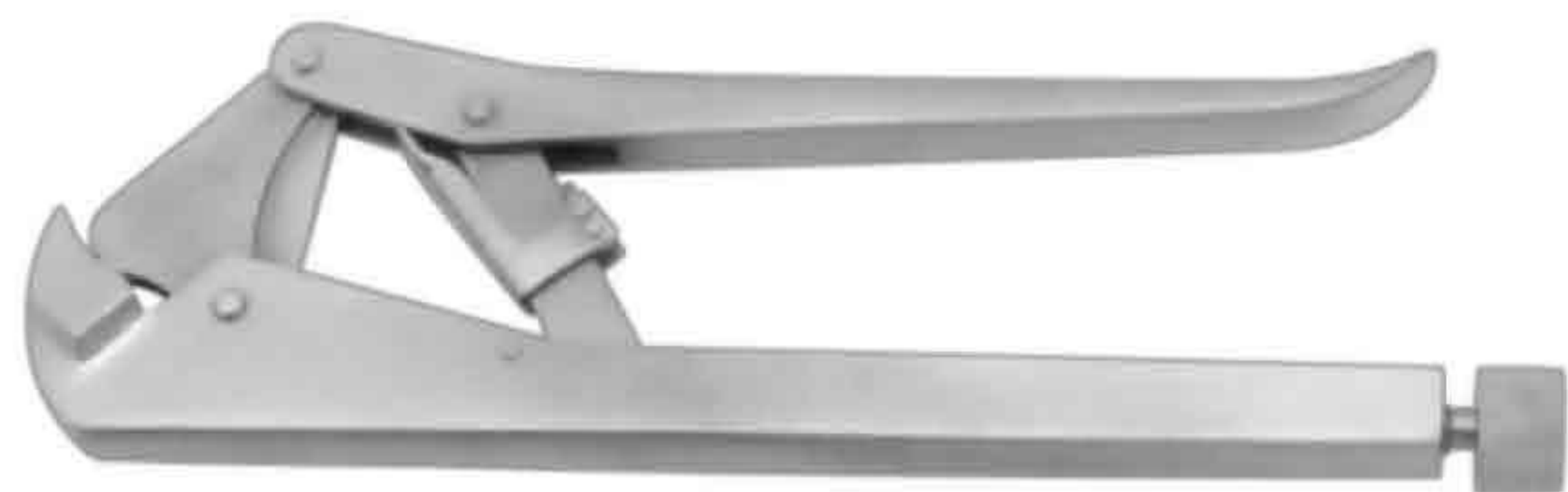


Plate Bend Forceps

SSC-23-19-16 = 220mm (Length)



Rejection Forceps

SSC-23-19-21 = 160mm (Large, Length)

SSC-23-19-22 = 140mm (Small, Length)



Desk Type Bending Press

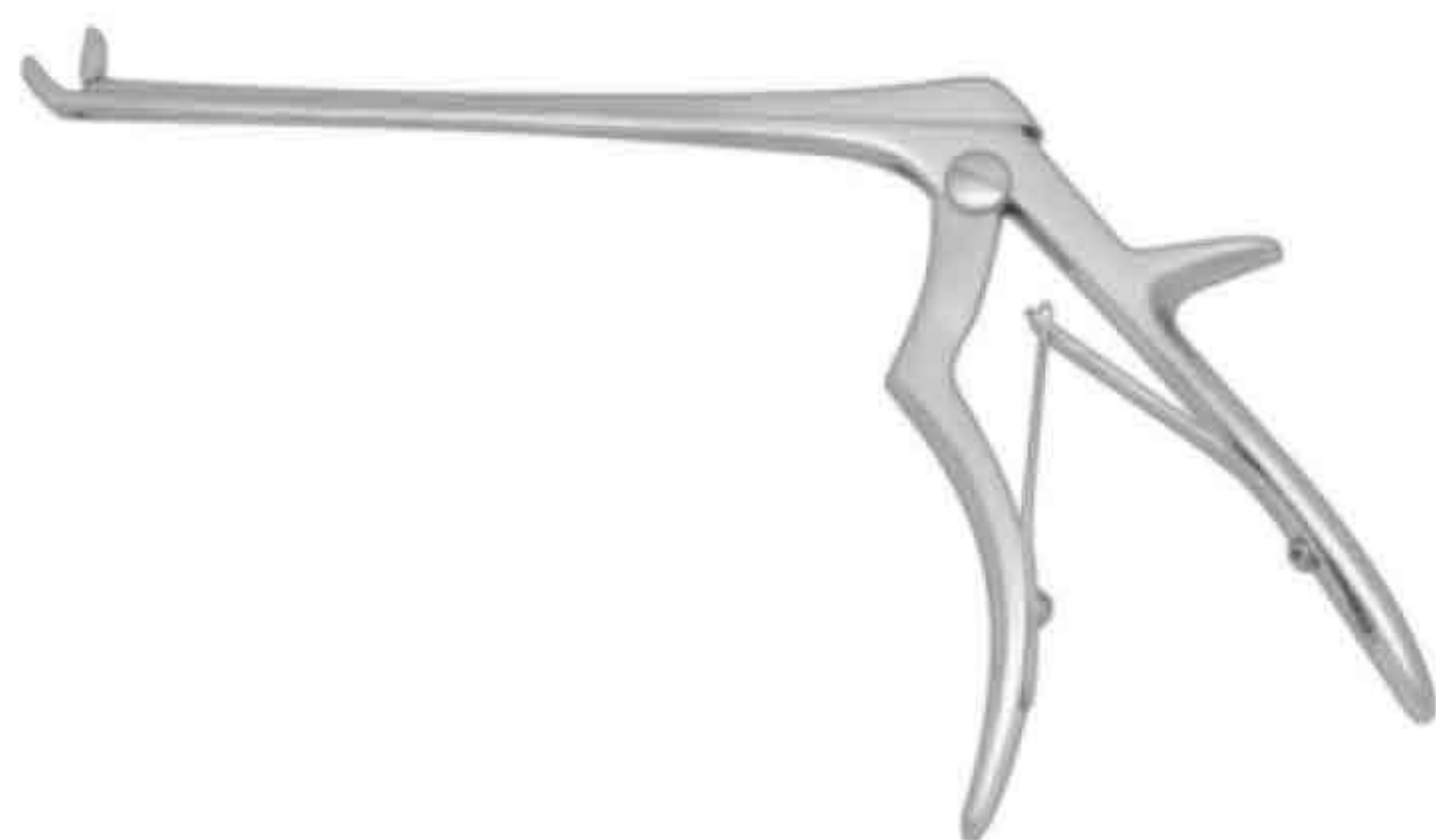
SSC-23-19-17

Desk type



Bedside Traction Rack

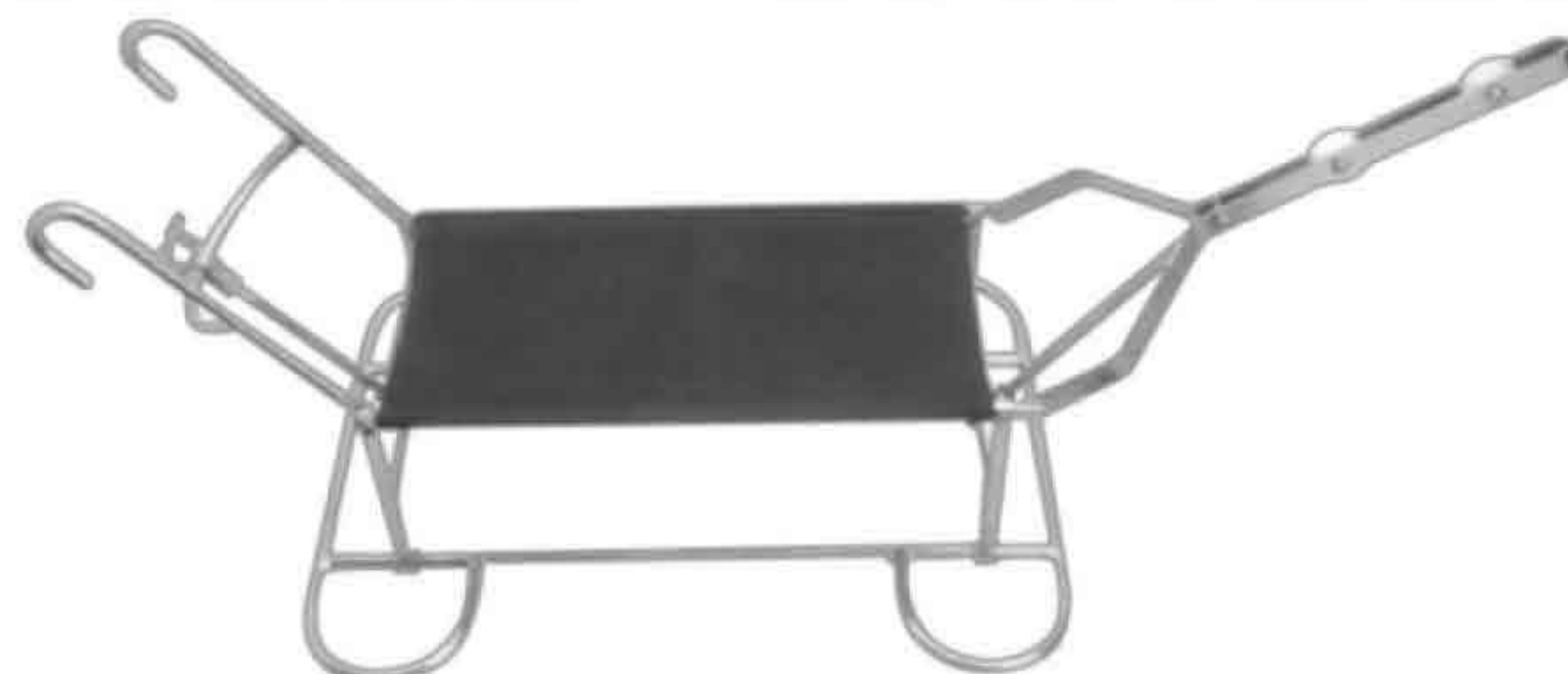
SSC-23-19-23



Spurling Rongeurs (Up Angle)

SSC-23-19-18 = 3, 4.5mm (Blade Width) 170mm (Length)

SSC-23-19-19 = 3, 4.5mm (Blade Width) 220mm (Length)



Blouse Rack

SSC-23-19-24



Wire Cutting Forceps

SSC-23-19-20 = 1.2mm

Maximum ranges of cutting 1.2mm diameter



Wire Pliers For Medical Application (Flat Sharp)

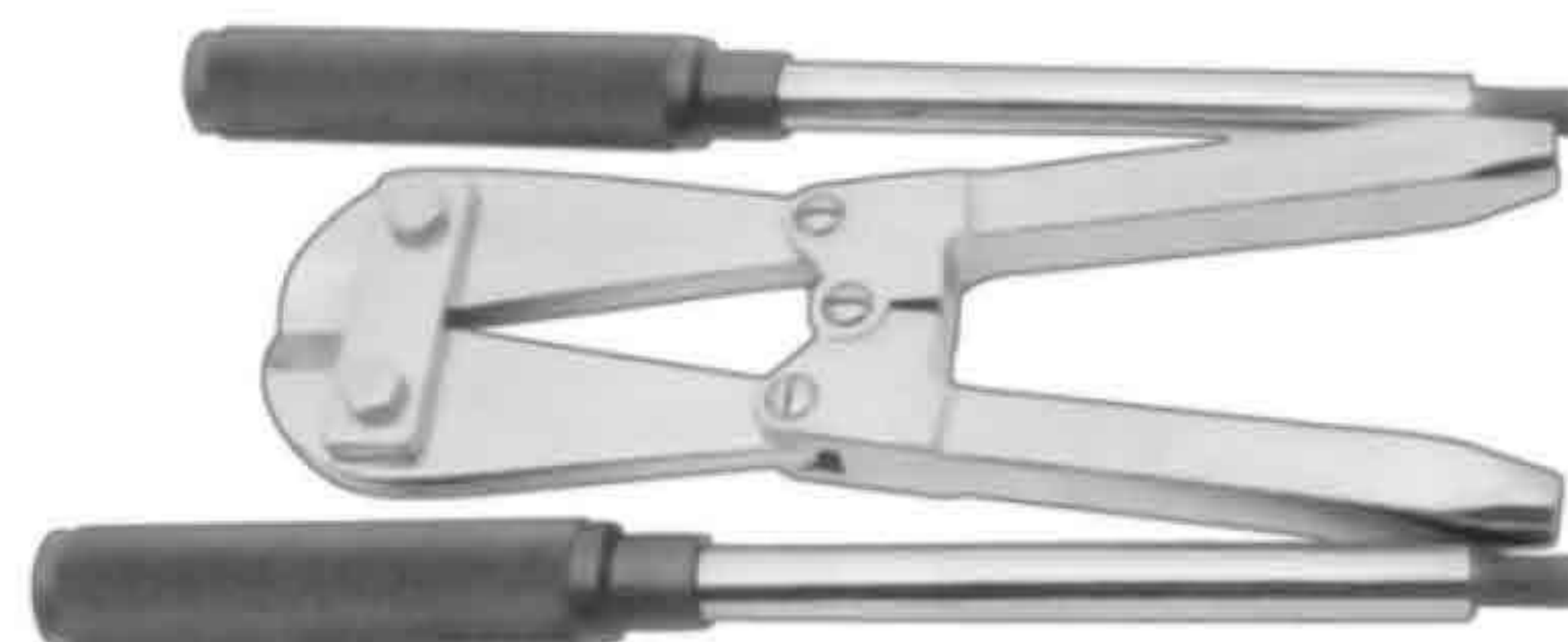
SSC-23-19-25 = 2mm

Maximum ranges of cutting 2mm diameter



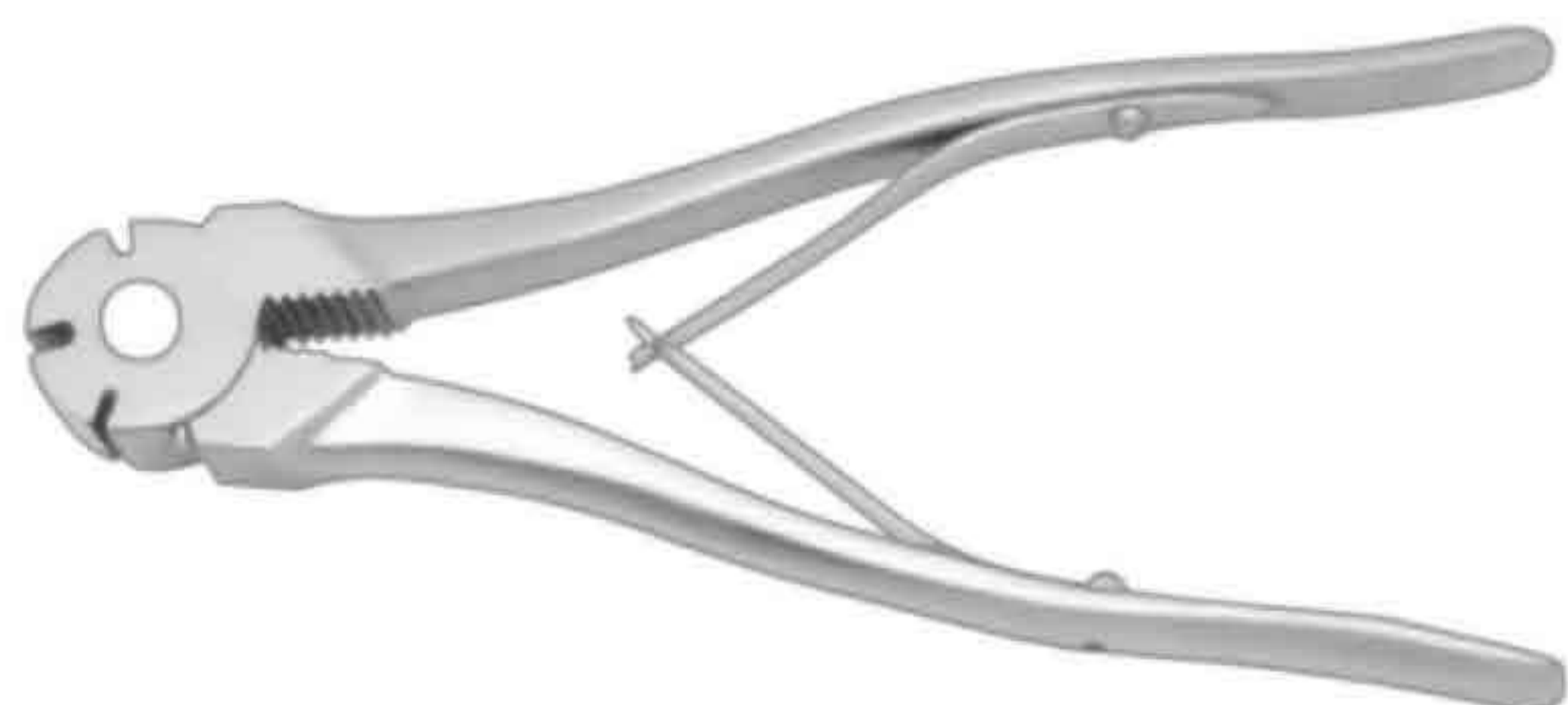
Wire Cutting Forceps

SSC-23-19-26 = 2.5mm
Maximum ranges of cutting 2.5mm diameter



Wire Cutting Forceps

SSC-23-19-30 = 6mm
Maximum ranges of cutting 6mm diameter



Bone Kirshner Scissors

SSC-23-19-27 = 2.5mm
Maximum ranges of cutting 2.5mm diameter

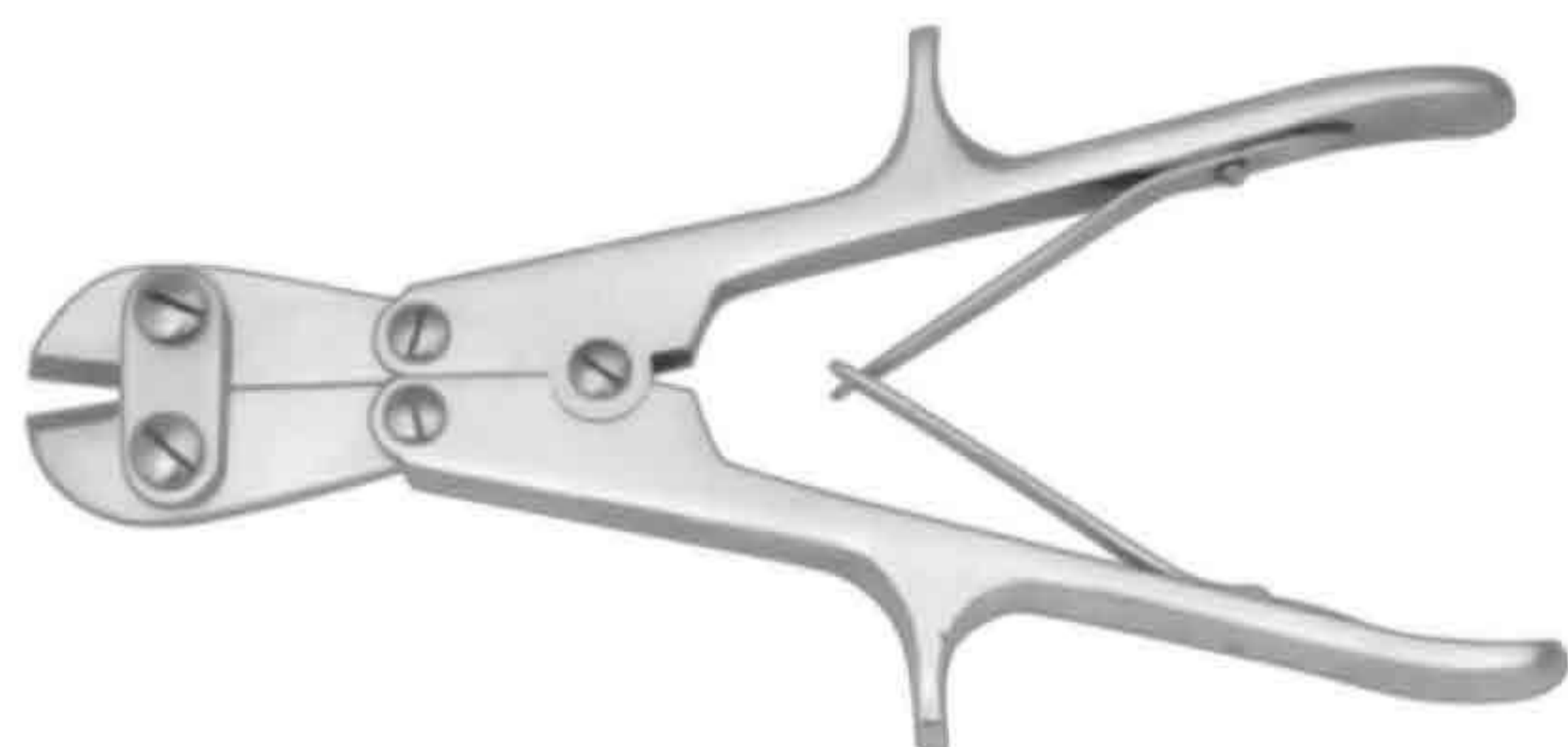


Asseous Pin Bending Forceps

SSC-23-19-31
Large size, Bend Kirshner Pin Use
Small size, Bend Kirshner Pin Use

SAWEEZ SAWEEZ

SAWEEZ SAWEEZ



Wire Cutting Forceps

SSC-23-19-28 = 2mm
Maximum ranges of cutting 2mm diameter

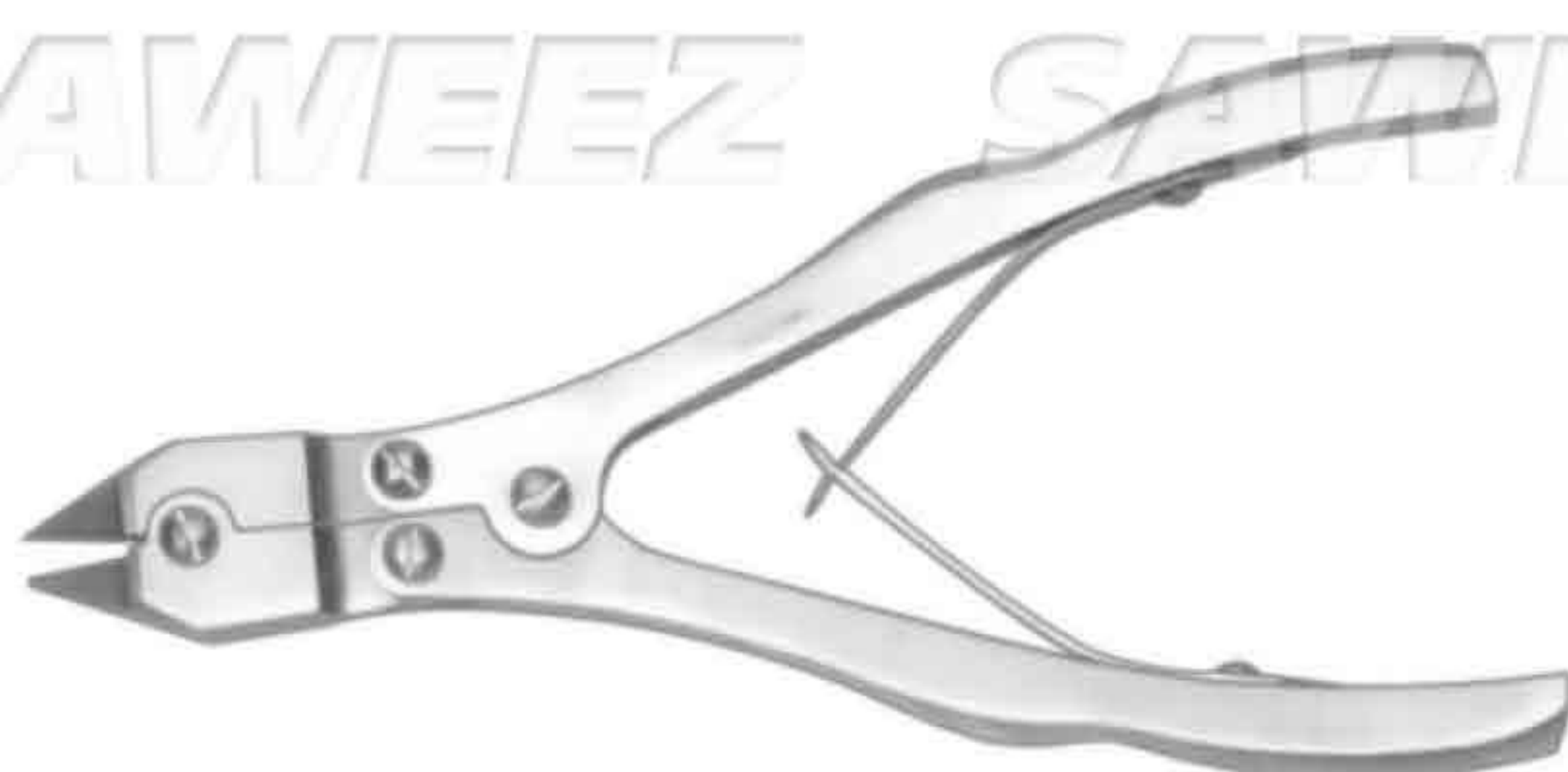


Auto Retractors

SSC-23-19-32 = 200mm (Length) 40mm, 60mm (Hook Depth)

SAWEEZ SAWEEZ

SAWEEZ SAWEEZ



Wire Cutting Forceps

SSC-23-19-29



Skull Tractive Bow

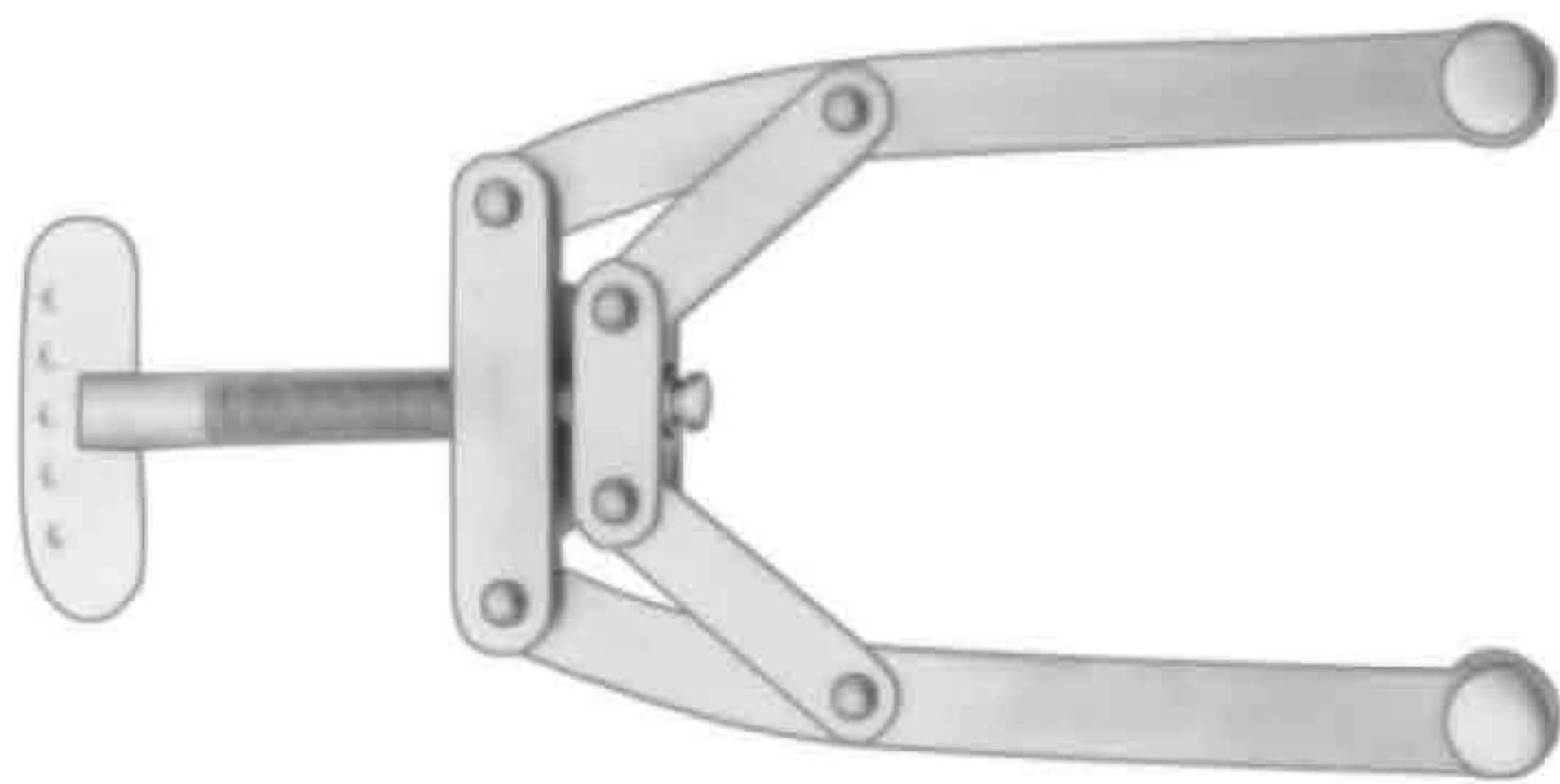
SSC-23-19-33
Large size



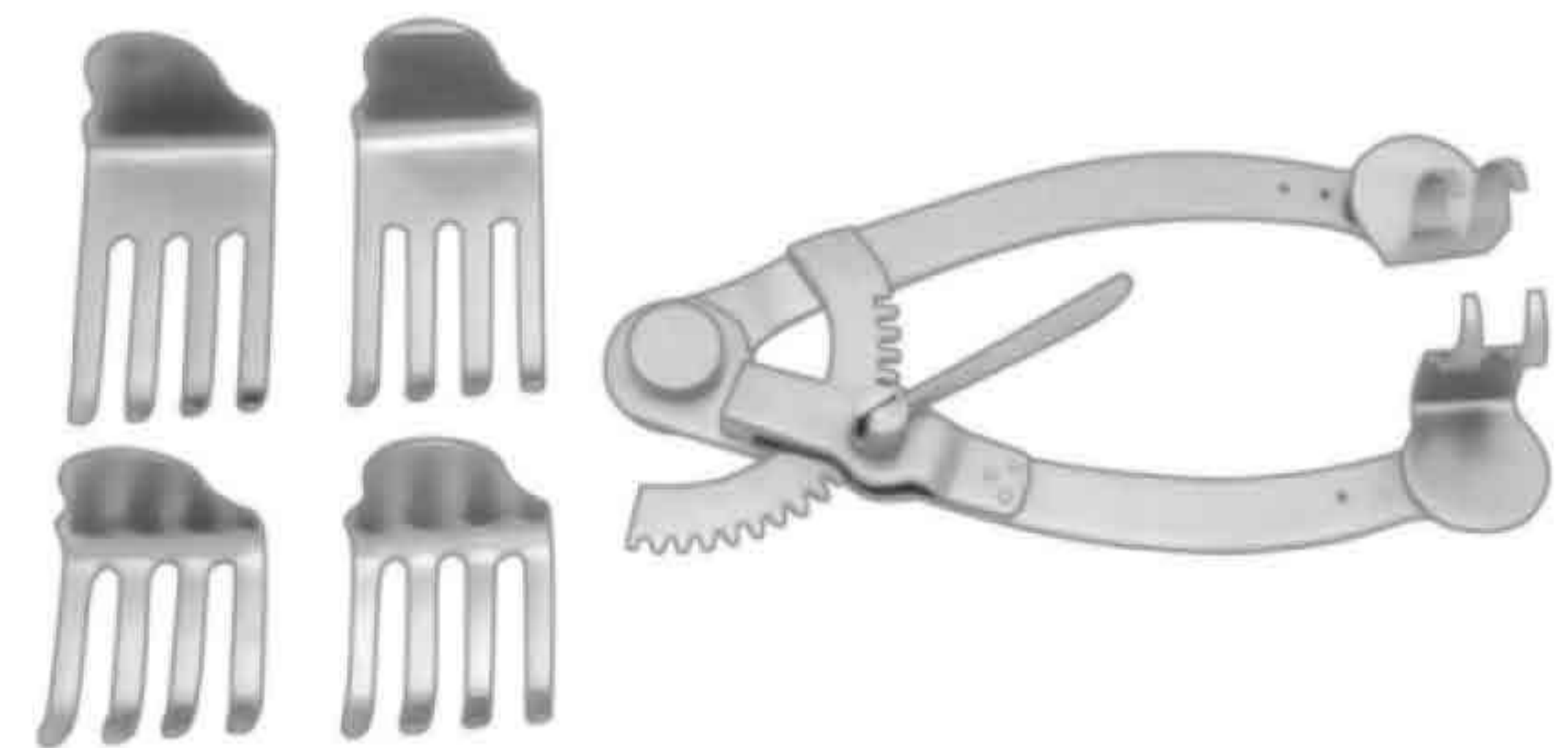
Skull Tractive Bow
SSC-23-19-34
Size: Medium, Small



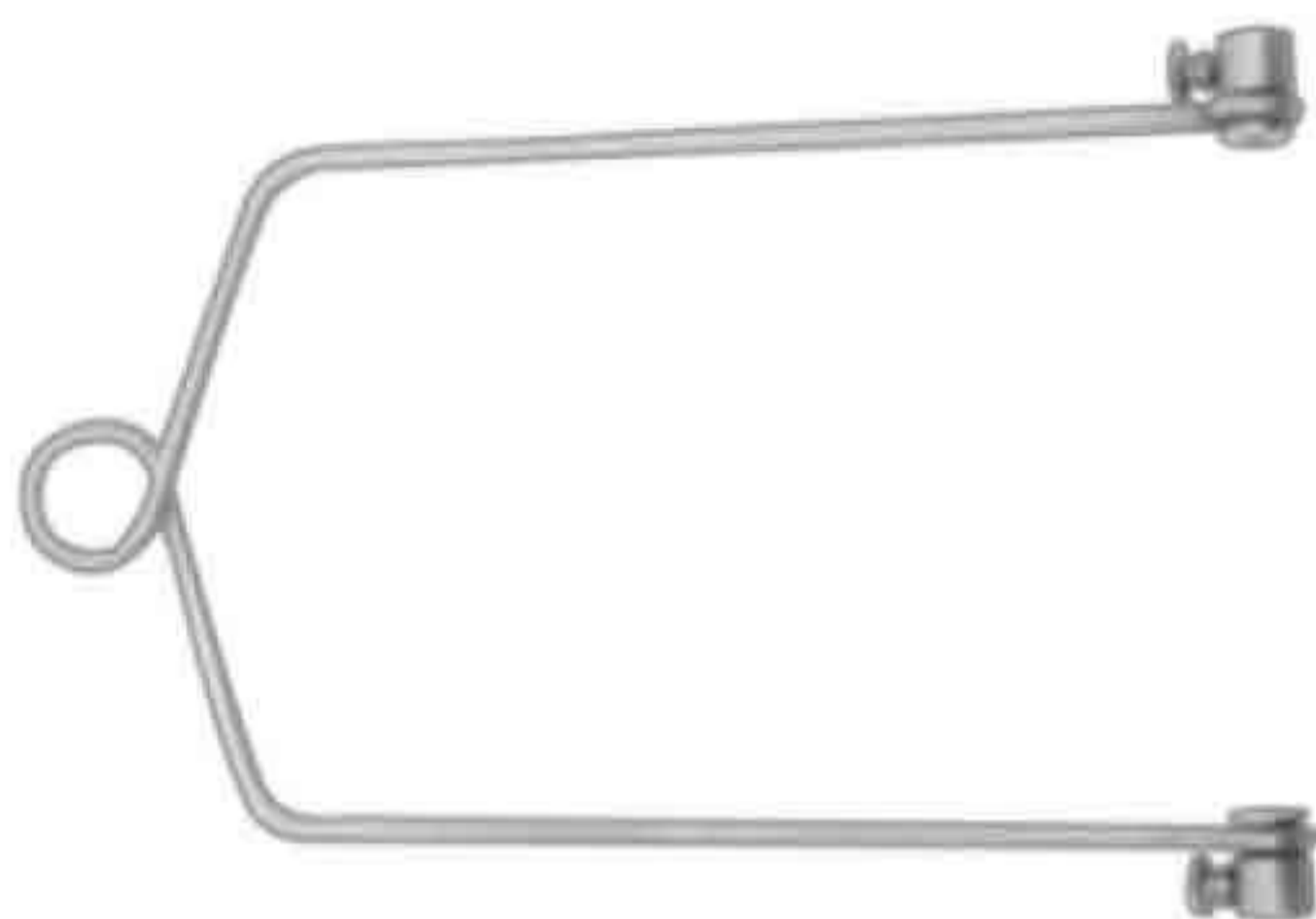
Retractor Self-Retaining Ratchet Typer
SSC-23-19-40 = 280mm (Length)



Kirshner Wires Traction Bow
SSC-23-19-35



Spine Retractor Multi-Purpose
SSC-23-19-41 = 3x1 set



Steinman Pins Traction Bow
SSC-23-19-36
Size: Large, medium, small



Compression Instrument
SSC-23-19-42 = 240mm (Length) Hip Nail Use



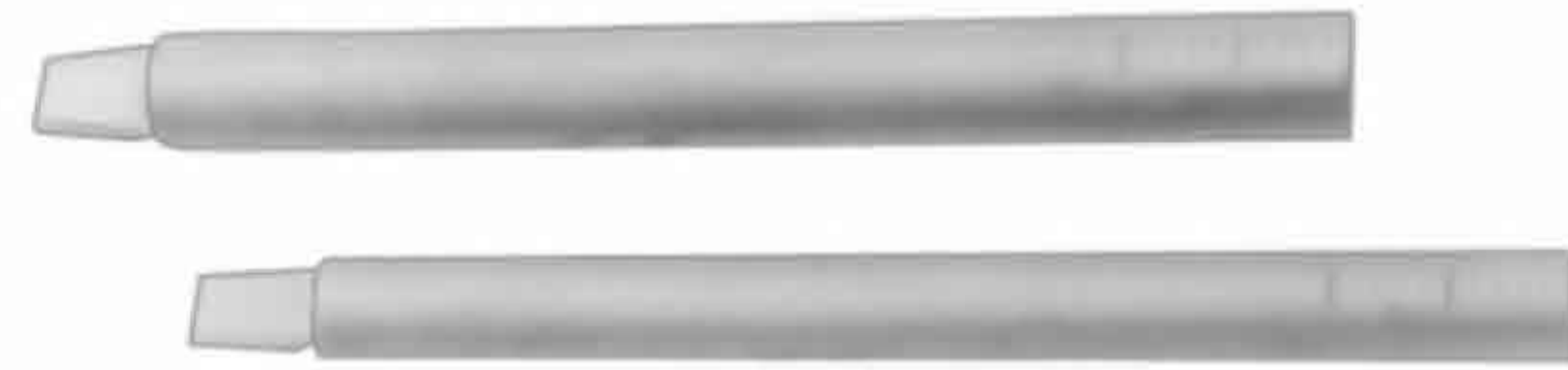
Angle Finer
SSC-23-19-37 = 95° (Mouth Angle)
SSC-23-19-38 = 130° (Mouth Angle)
SSC-23-19-39 = 135° (Mouth Angle) Hip Nail Use



Cervical Vertebrae Trepine
SSC-23-19-43 = 9mm (Diam)
SSC-23-19-44 = 10mm (Diam)
SSC-23-19-45 = 11mm (Diam)
SSC-23-19-46 = 12mm (Diam)
SSC-23-19-47 = 13mm (Diam)
SSC-23-19-48 = 14mm (Diam)
SSC-23-19-49 = 15mm (Diam)
SSC-23-19-50 = 16mm (Diam)
Used for Cervical vertebra and lumbar vertebra



Inserter Extractor
SSC-23-19-51 = 200mm (Length) Hip Nail Use



Indicator Rotating Core
SSC-23-19-57 = 8mm
SSC-23-19-58 = 9mm
SSC-23-19-59 = 10mm
SSC-23-19-60 = 11mm
SSC-23-19-66 = 12mm
SSC-23-19-67 = 13mm
SSC-23-19-68 = 14mm
SSC-23-19-69 = 15mm



Combined Reamer
SSC-23-19-52 = Size 250mm (for DHS/DCS)



Periosteal Elevators
SSC-23-19-61 = 300mm (Length)
Sharp mouth, micro sharp mouth



Screw Tap
SSC-23-19-53 = 270mm (Length) Hip Nail Use



Nerve Root Retractors
SSC-23-19-62 = Size 3mm, 90° (Mouth Angle)
SSC-23-19-63 = Size 5mm, 135° (Mouth Angle)
SSC-23-19-64 = Size 7mm, 180° (Mouth Angle)



Screw Holding Forceps
SSC-23-19-54 = 3.5 (To Hold Dian)
SSC-23-19-55 = 4 (To Hold Dian)
SSC-23-19-56 = 4.5mm (To Hold Dian)



Muscle Retractors
SSC-23-19-65 = Size: Large, Small

**Cervical Vertebra Retractor**

SSC-23-19-70

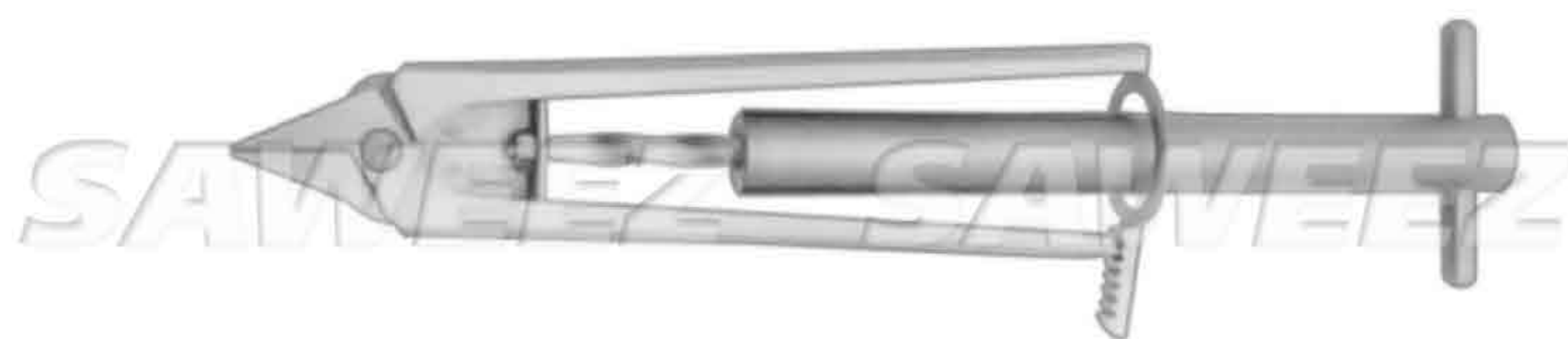
Size: Large, Small

**Shank Bone and Splinter Bone Retractor**

SSC-23-19-73 Size: Bread Shape

**Patella Clamp**

SSC-23-19-71 = 190mm (Length)

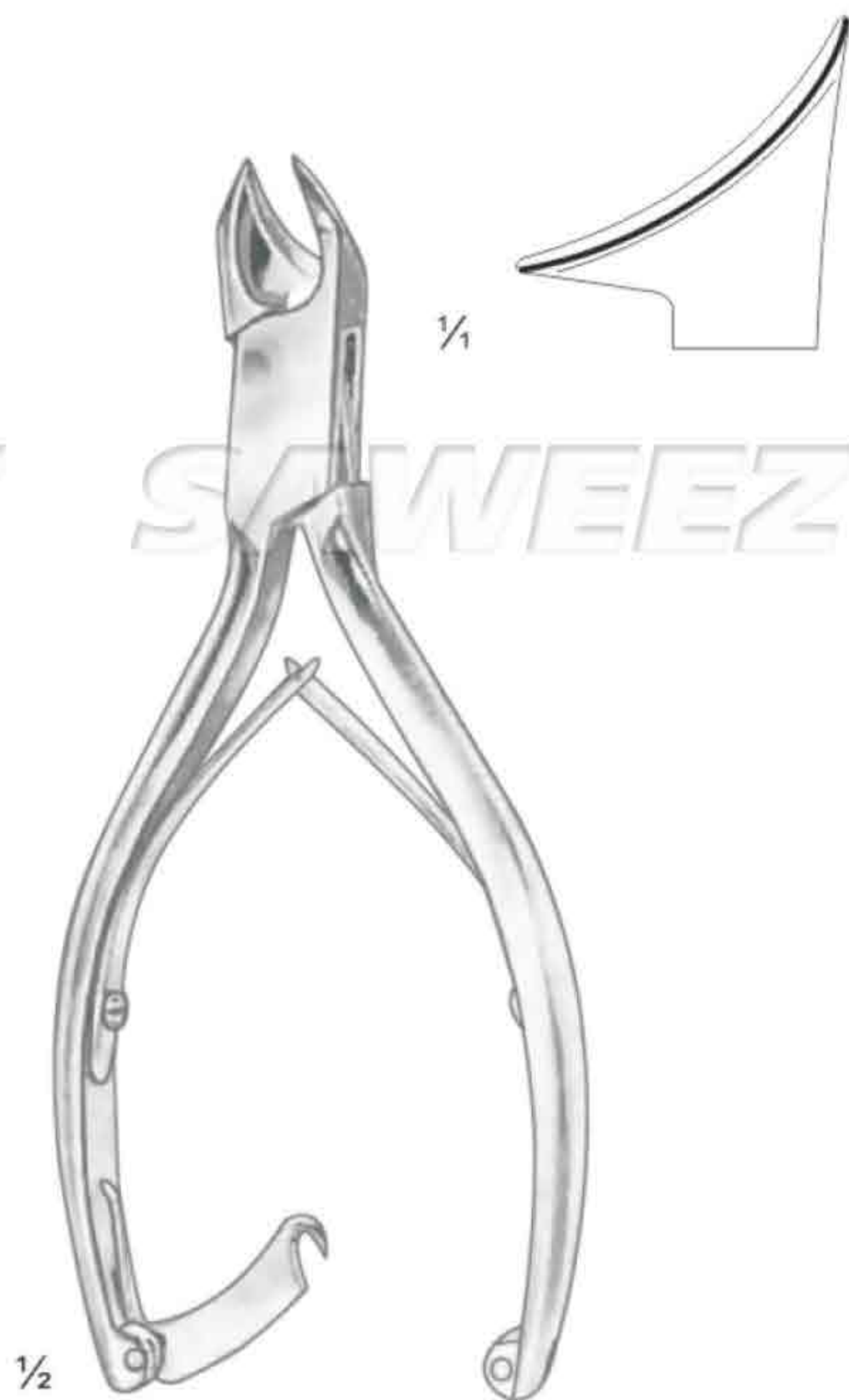
**Jet Wire Twister**

SSC-23-19-74

**Spinal Plate Retractor**

SSC-23-19-72 = Size: Large, Small

**Conductor Steel Tyre**SSC-23-19-75 = Size: Straight, Left Bend,
Right Bend, Form Bend



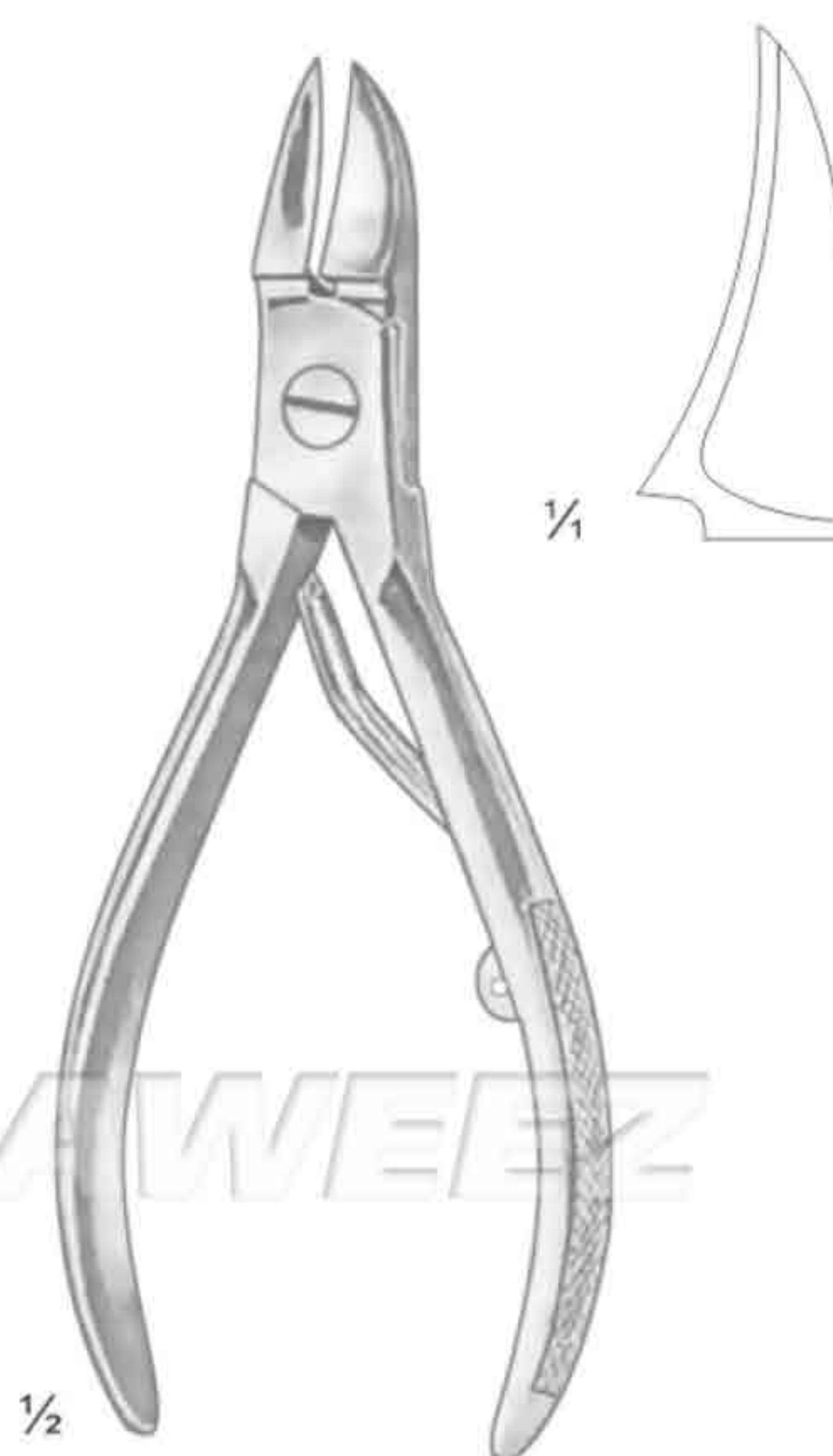
SSC-25-11-11
14.0 cm / 5½"



SSC-25-11-12 - 14.0 cm / 5½"
SSC-25-11-13 - 16.0 cm / 6¼"



Turnbull
SSC-25-11-14 - 11½ cm / 4½"
SSC-25-11-15 - 13.0 cm / 5"



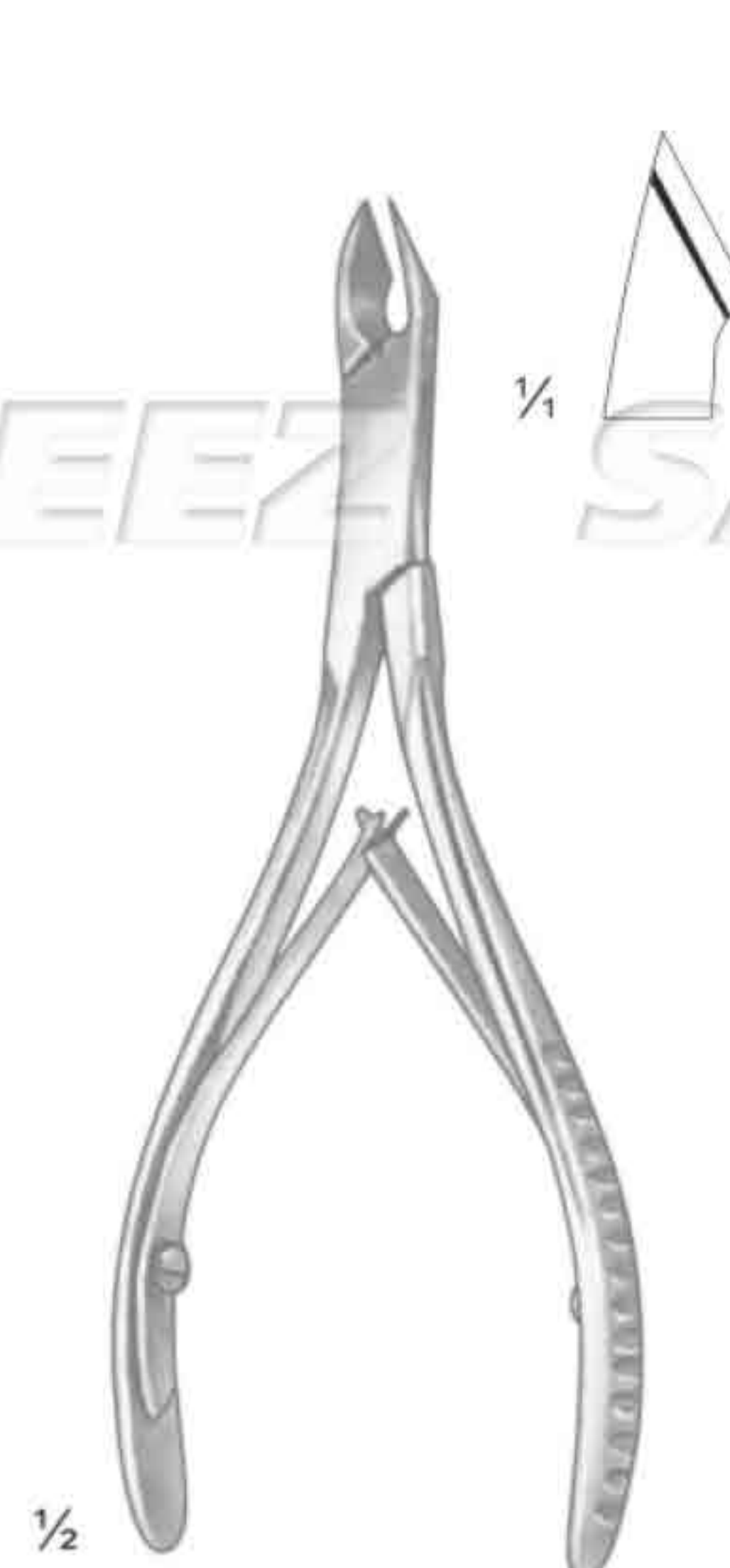
SSC-25-11-16
13.0 cm / 5"



SSC-25-11-17
12.0 cm / 4 3/4"



SSC-25-11-18 - 11.0 cm / 4 1/2"
SSC-25-11-19 - 13.0 cm / 5"
SSC-25-11-20 - 15.0 cm / 6"



SSC-25-11-21 - 11.0 cm / 4 1/2"
SSC-25-11-22 - 13.0 cm / 5"

SAWEEZ SAWEEZ SAWEEZ SAWEEZ



SSC-25-11-23
10.5 cm / 4 1/4"



Cohen
SSC-25-11-24
13.0 cm / 5"

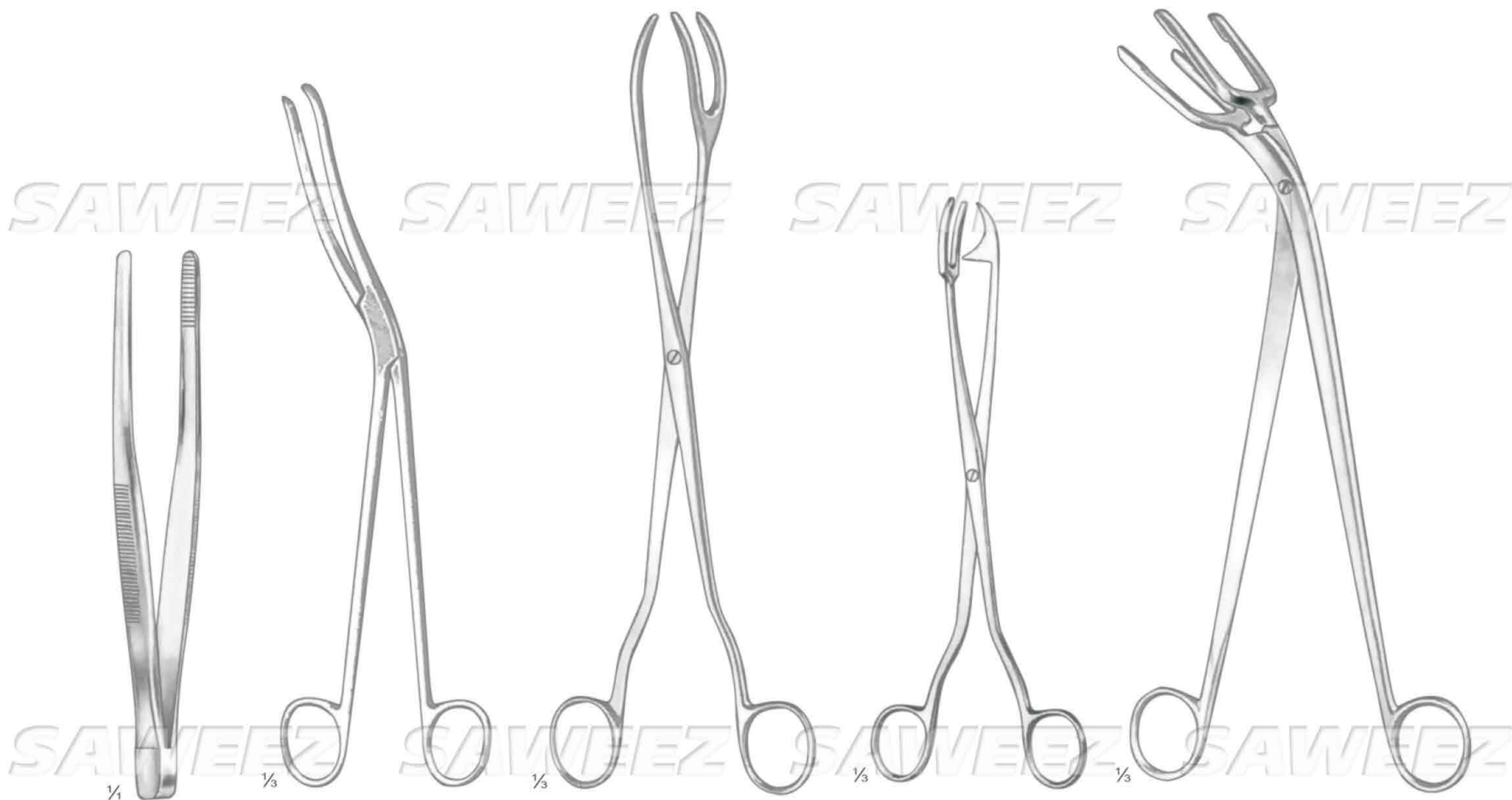


Cohen
SSC-25-11-25
13.0 cm / 5"

SAWEEZ SAWEEZ SAWEEZ SAWEEZ



SAWEEZ SAWEEZ SAWEEZ SAWEEZ



SSC-25-11-26
20.0 cm / 8"

Iodine Forceps
of acrylic

Cheatle
SSC-25-11-27
27.0 cm / 10½"

Sterilizing Forceps

SSC-25-11-28
30.0 cm / 12"

Rogge
SSC-25-11-29
23.0 cm / 9"

Pye-Smith (Harrison)
SSC-25-11-30
30.0 cm / 12"

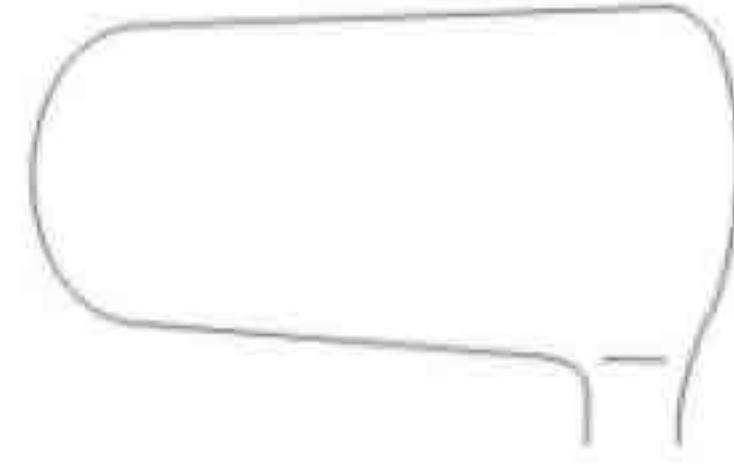


¼

SSC-27-11-11



SSC-27-11-12



SSC-27-11-13

SAWEEZ

SAWEEZ

SAWEEZ

SAWEEZ



½

Goldsmith (Thudichum)



¼

SSC-27-11-14



SSC-27-11-15



SSC-27-11-16



½

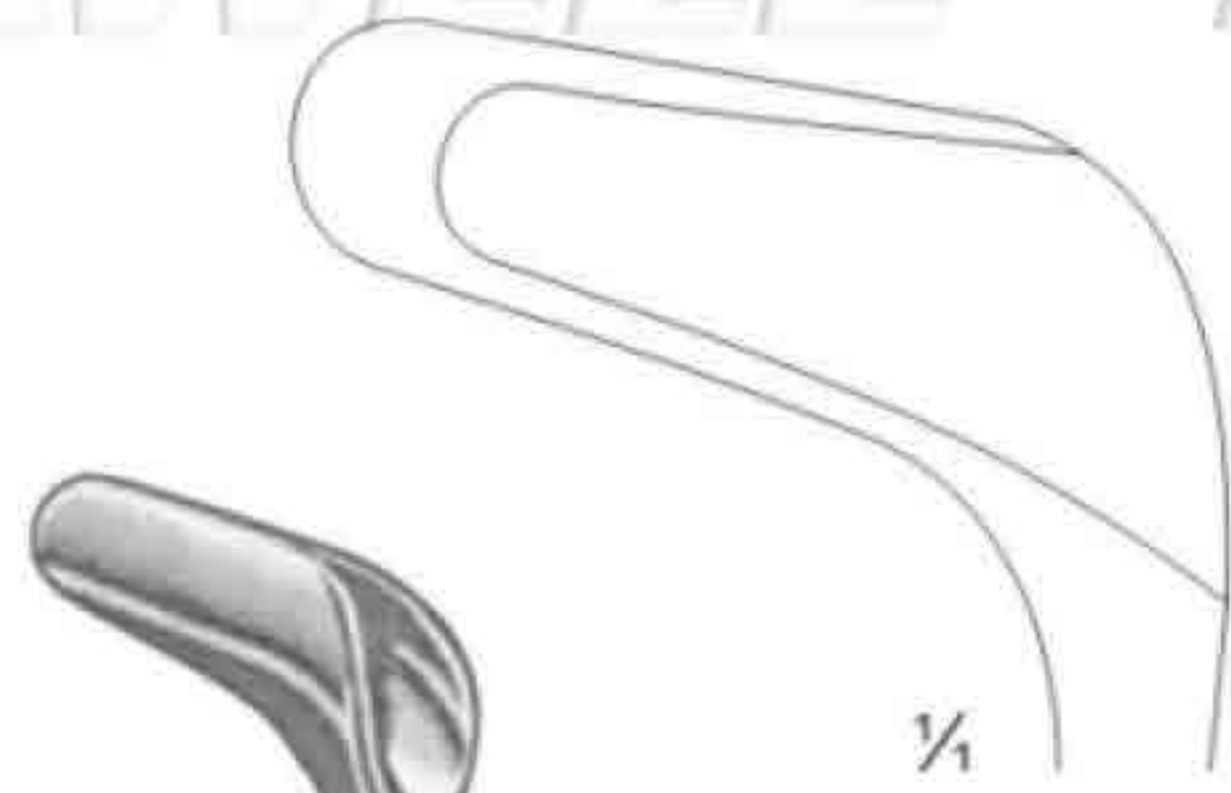
Voltolini

SAWEEZ

SAWEEZ

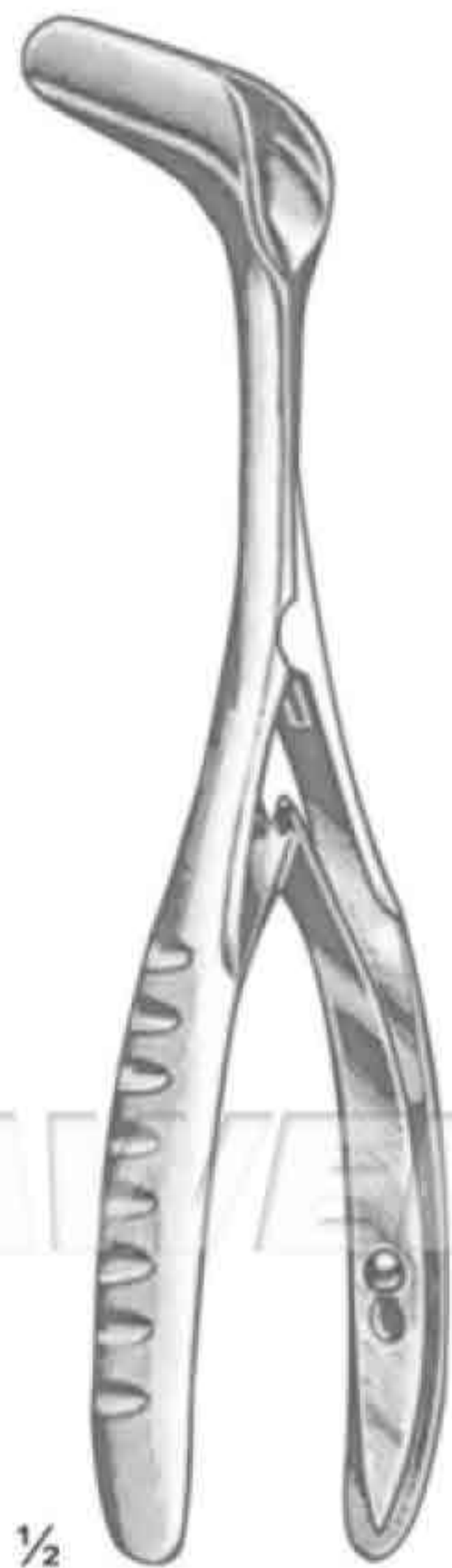
SAWEEZ

SAWEEZ



¼

SSC-27-11-17
14.0 cm / 5½"



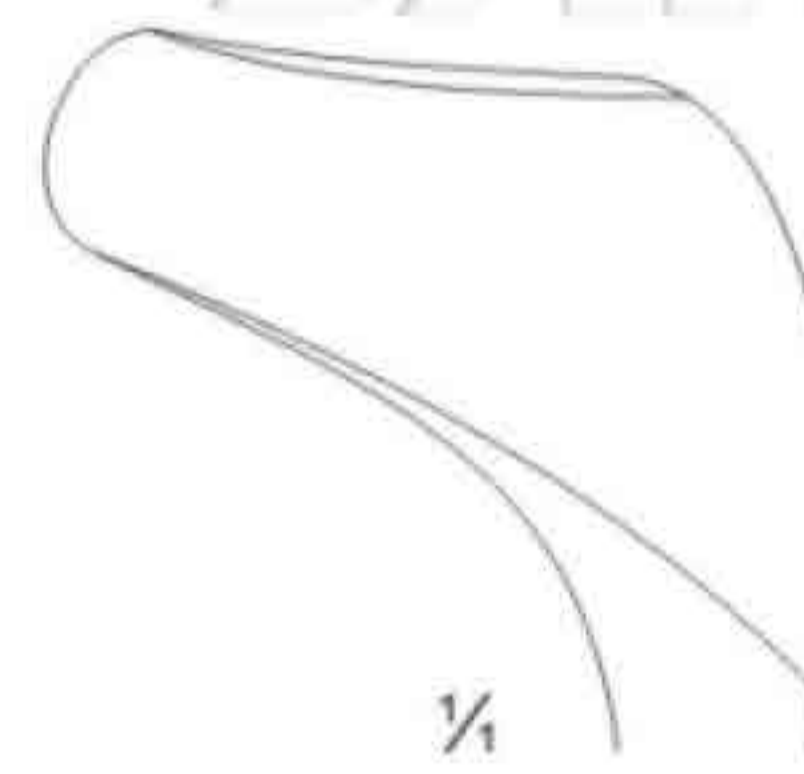
½

Schwarz



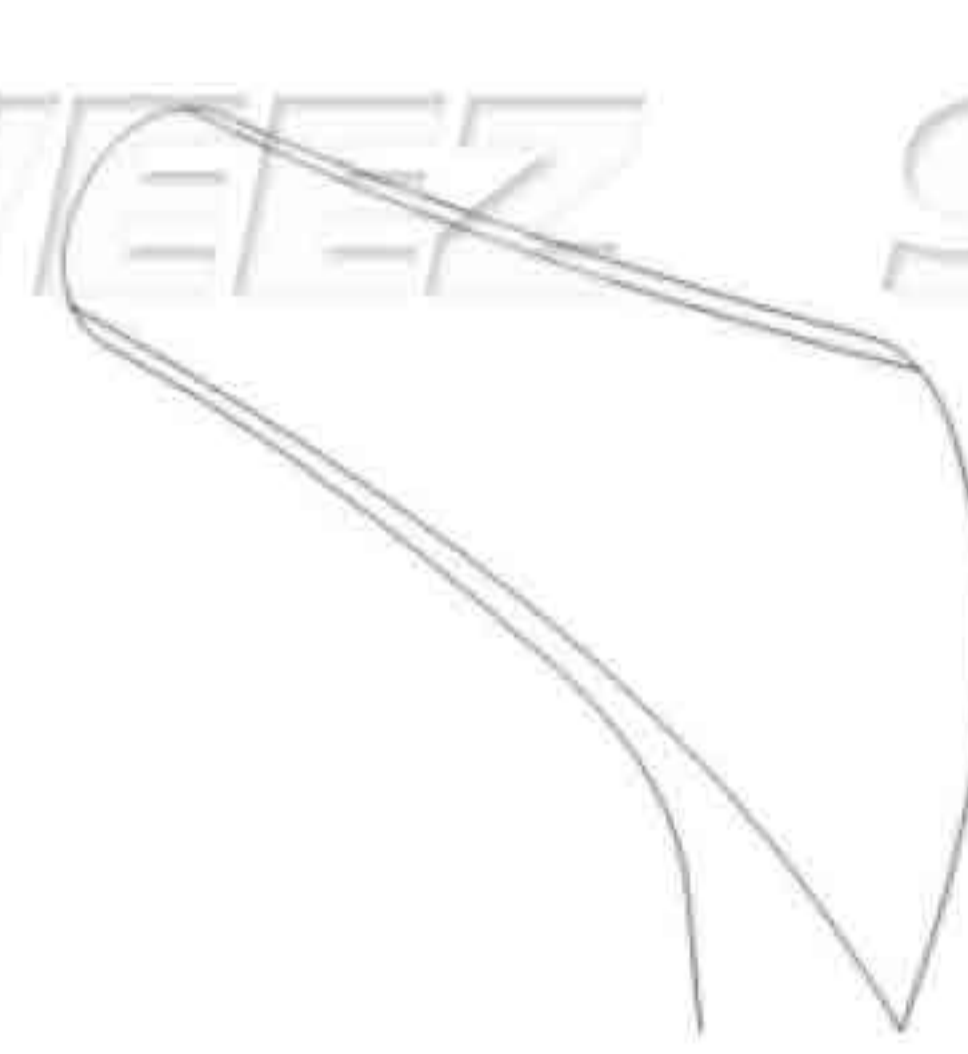
½

Hartmann-Halle
15.0 cm / 6"



¼

SSC-27-11-18



SSC-27-11-19



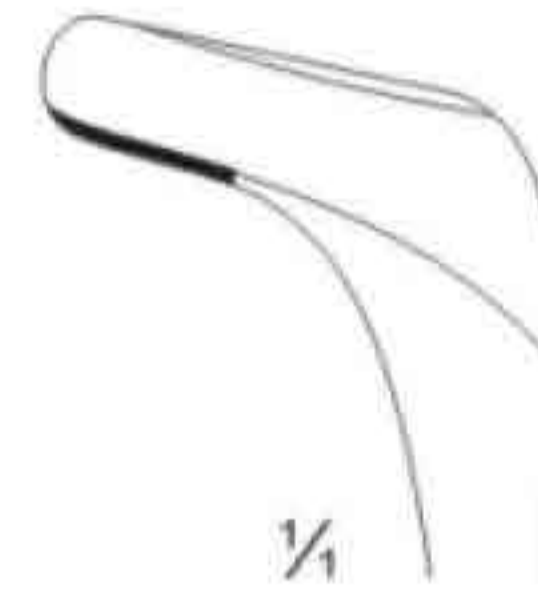
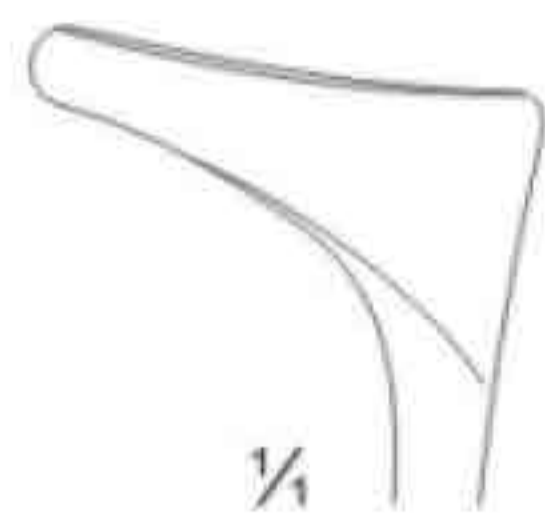
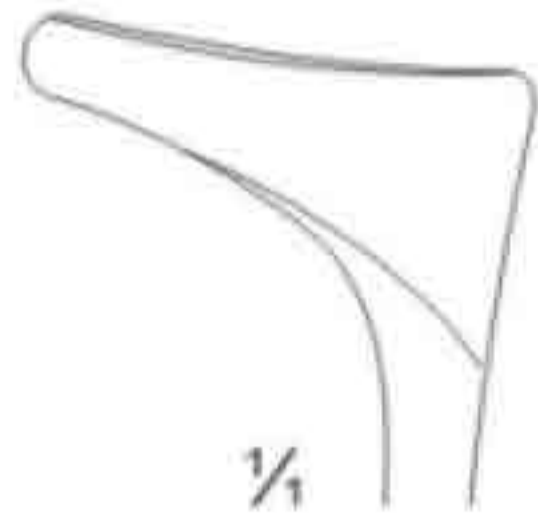
SSC-27-11-20

SAWEEZ

SAWEEZ

SAWEEZ

SAWEEZ

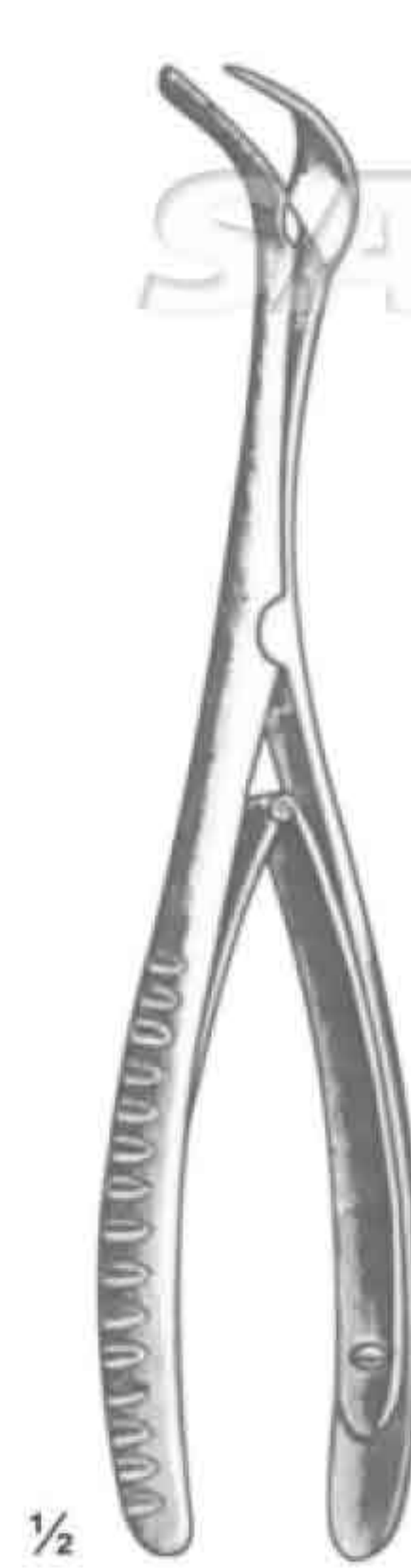
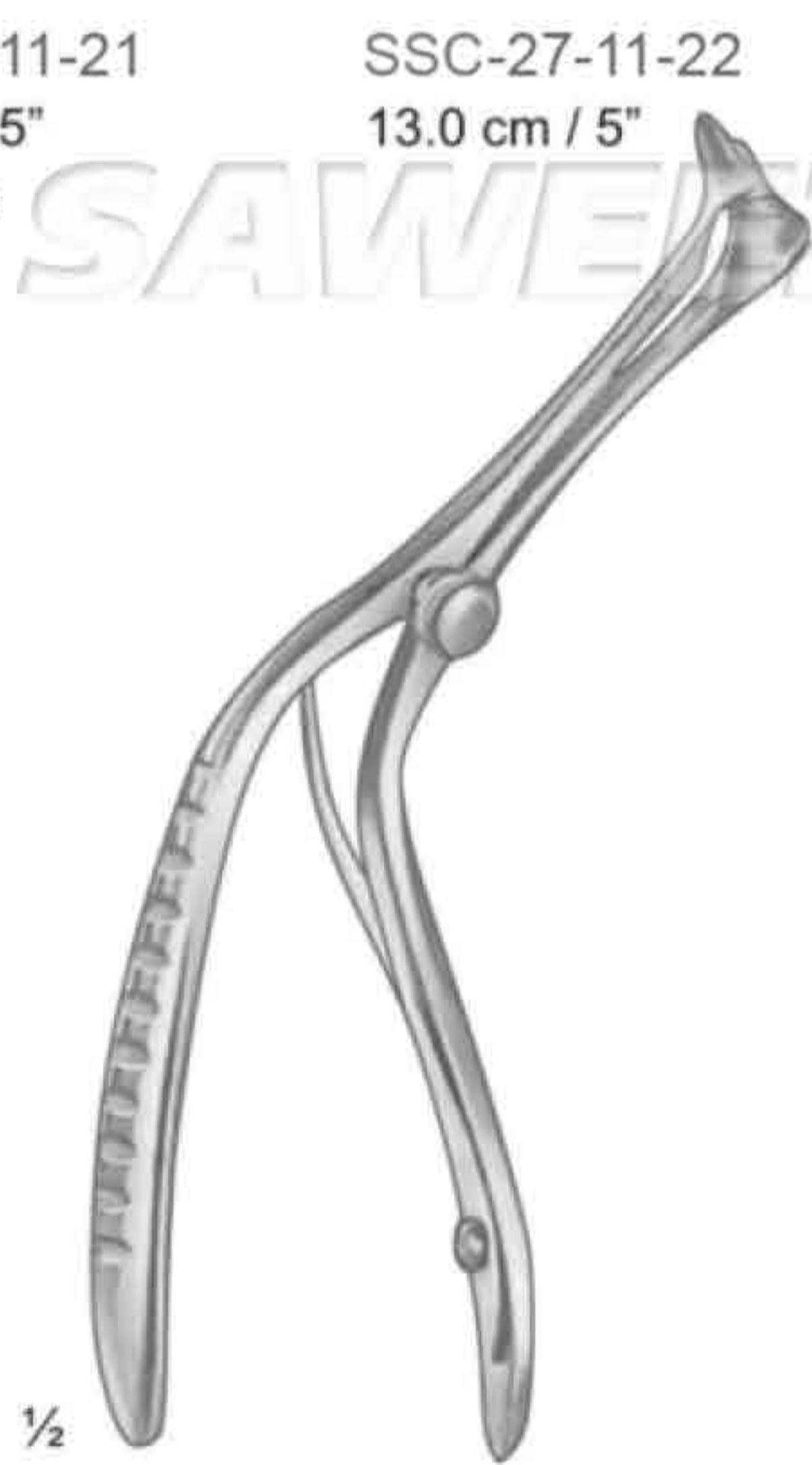


SSC-27-11-21
13.0 cm / 5"
Pediatrics

SSC-27-11-22
13.0 cm / 5"

SSC-27-11-23
13.5 cm / 5¼"

SSC-27-11-24
13.5 cm / 5¼"



Special Model

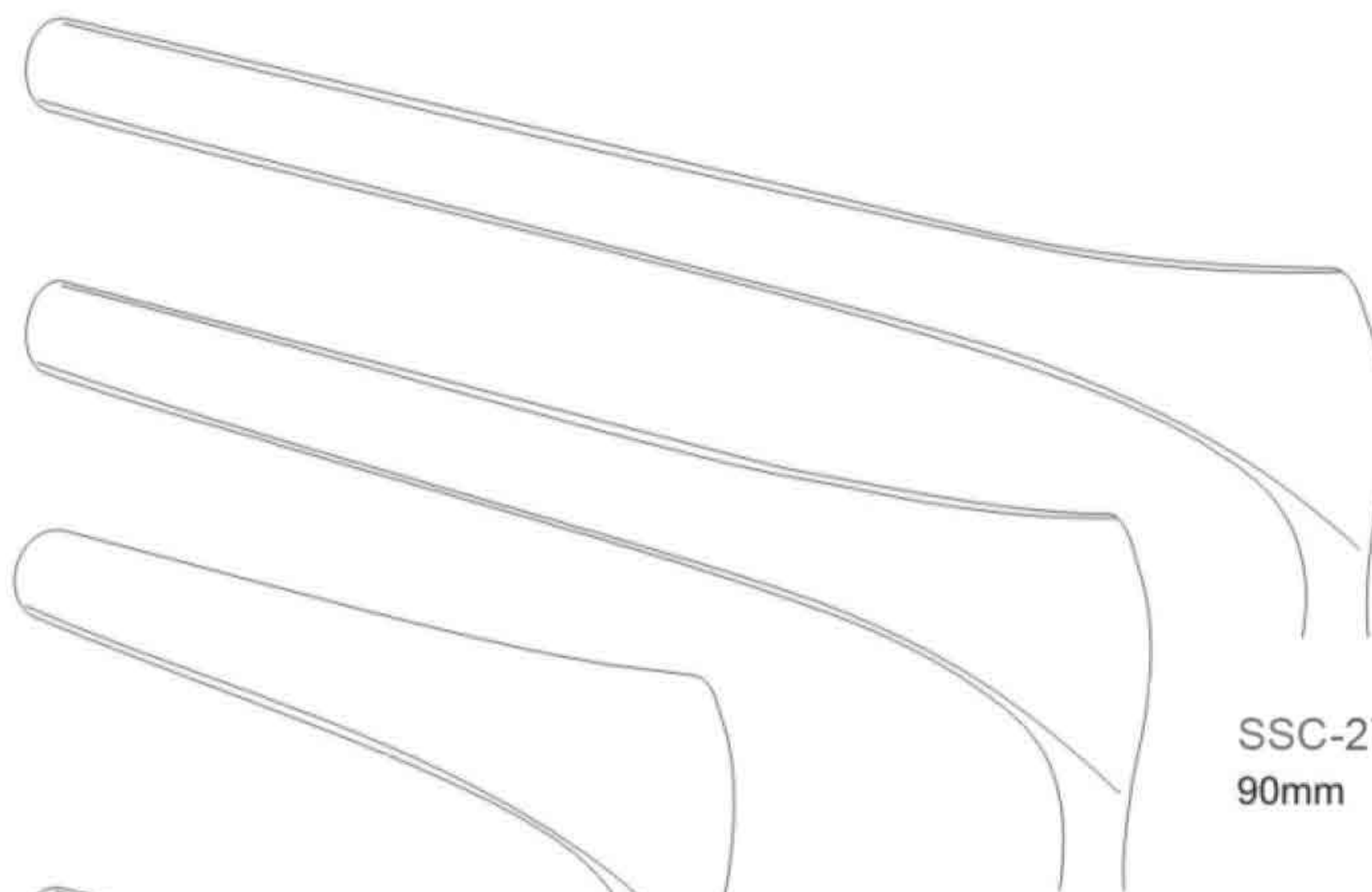
Special Model

Tieck-Halle

Tieck-Halle



Killian
13.0 cm / 5"



SSC-27-11-26
50mm

SSC-27-11-27
75mm

SSC-27-11-28
90mm

SSC-27-11-25
35mm



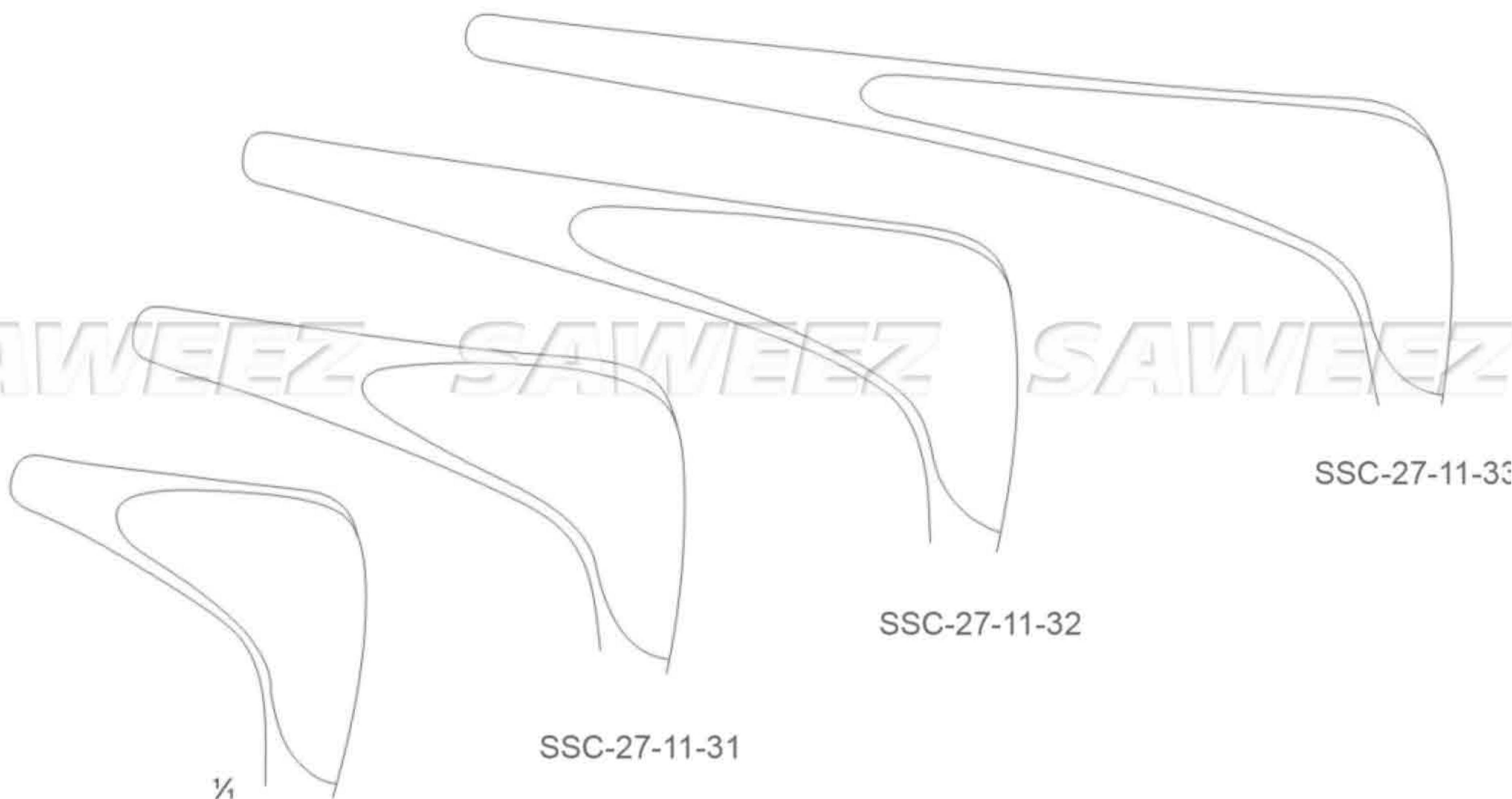
Mod. Wien

SSC-27-11-29
14.5 cm / 5¾"



1/2

Cottle
15.0 cm / 6"



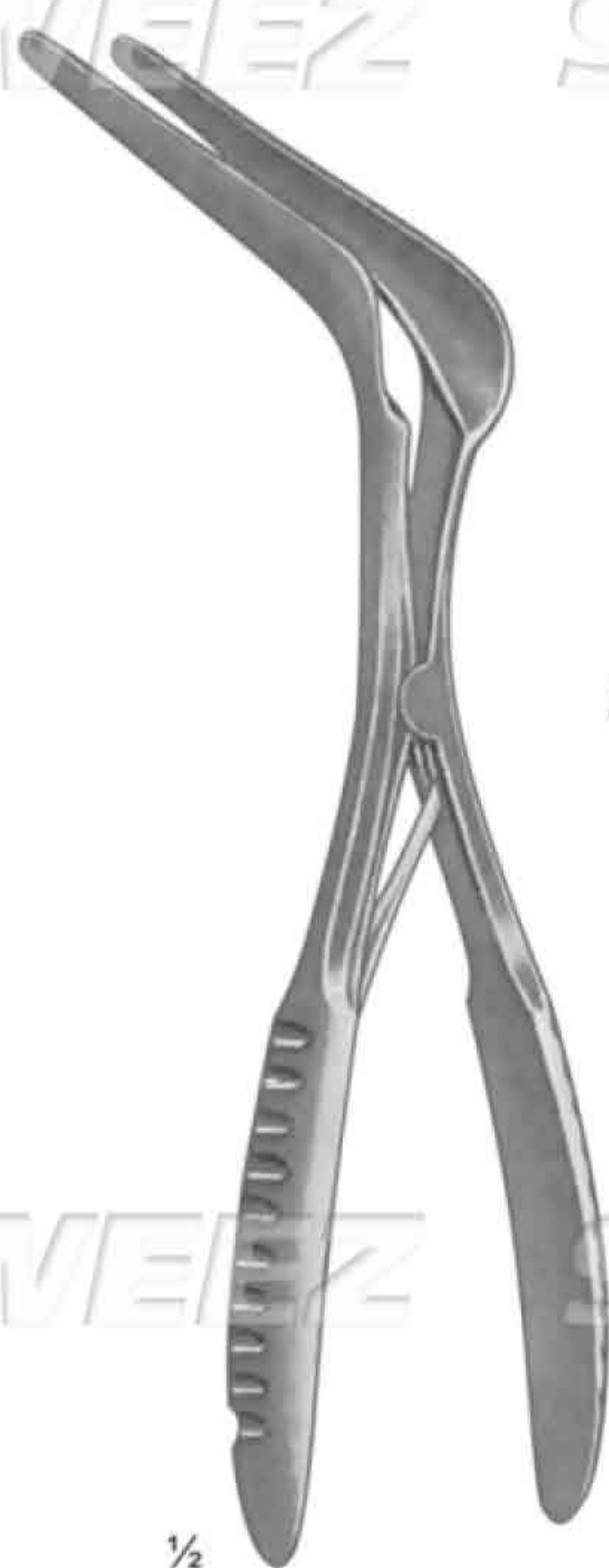
1/4

SSC-27-11-30

SSC-27-11-31

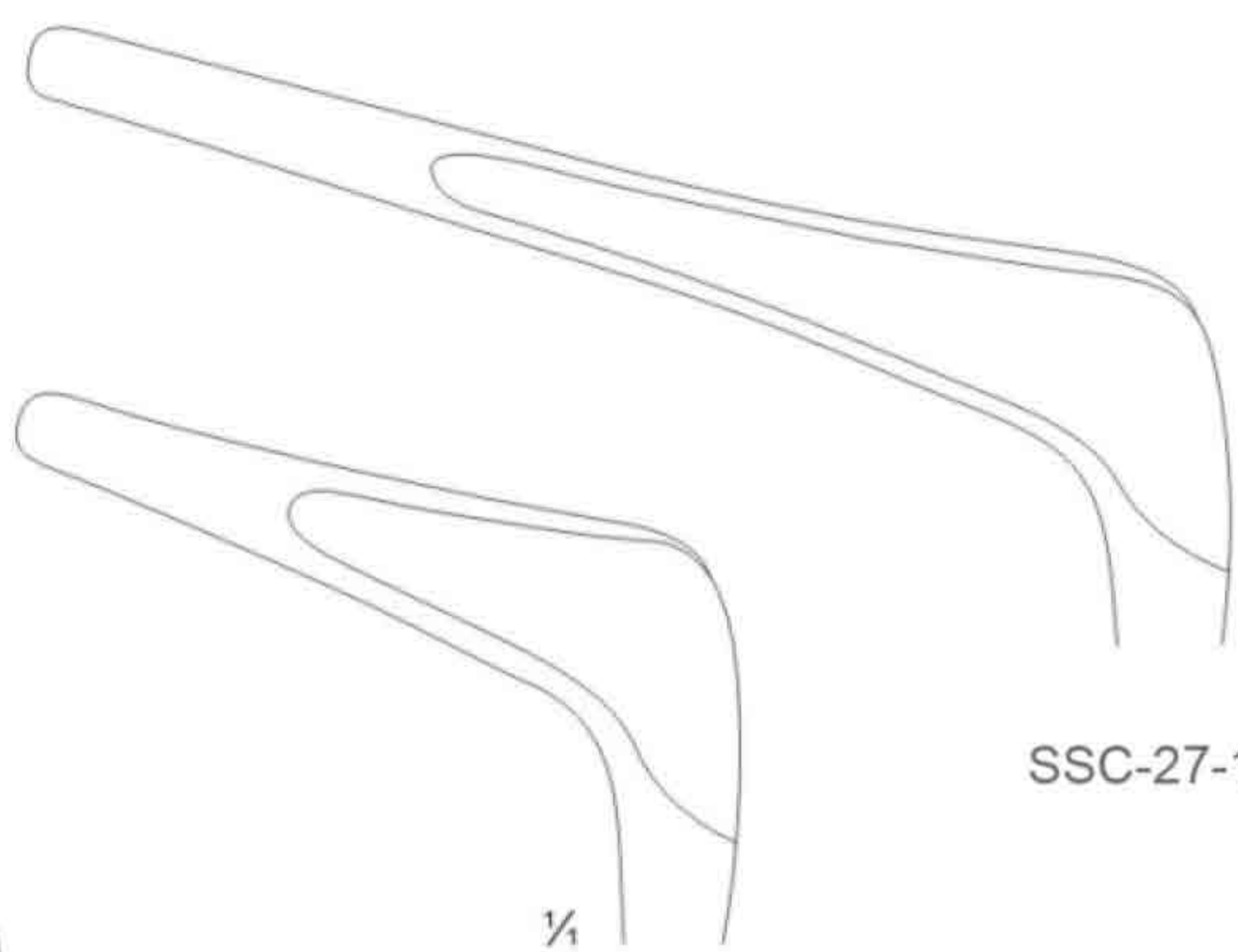
SSC-27-11-32

SSC-27-11-33



1/2

Cottle
14.0 cm / 5 1/2"



1/4

SSC-27-11-34

SSC-27-11-35

Dull black
chromium
plated



1/2

Yankauer
SSC-27-11-36
19.0 cm / 7 1/2"





Hartmann
SSC-27-11-44
20.0 cm / 8"



Littauer
SSC-27-11-45
18.0 cm / 7"



Killian
SSC-27-11-46
17.0 cm / 6 3/4"



SSC-27-11-48



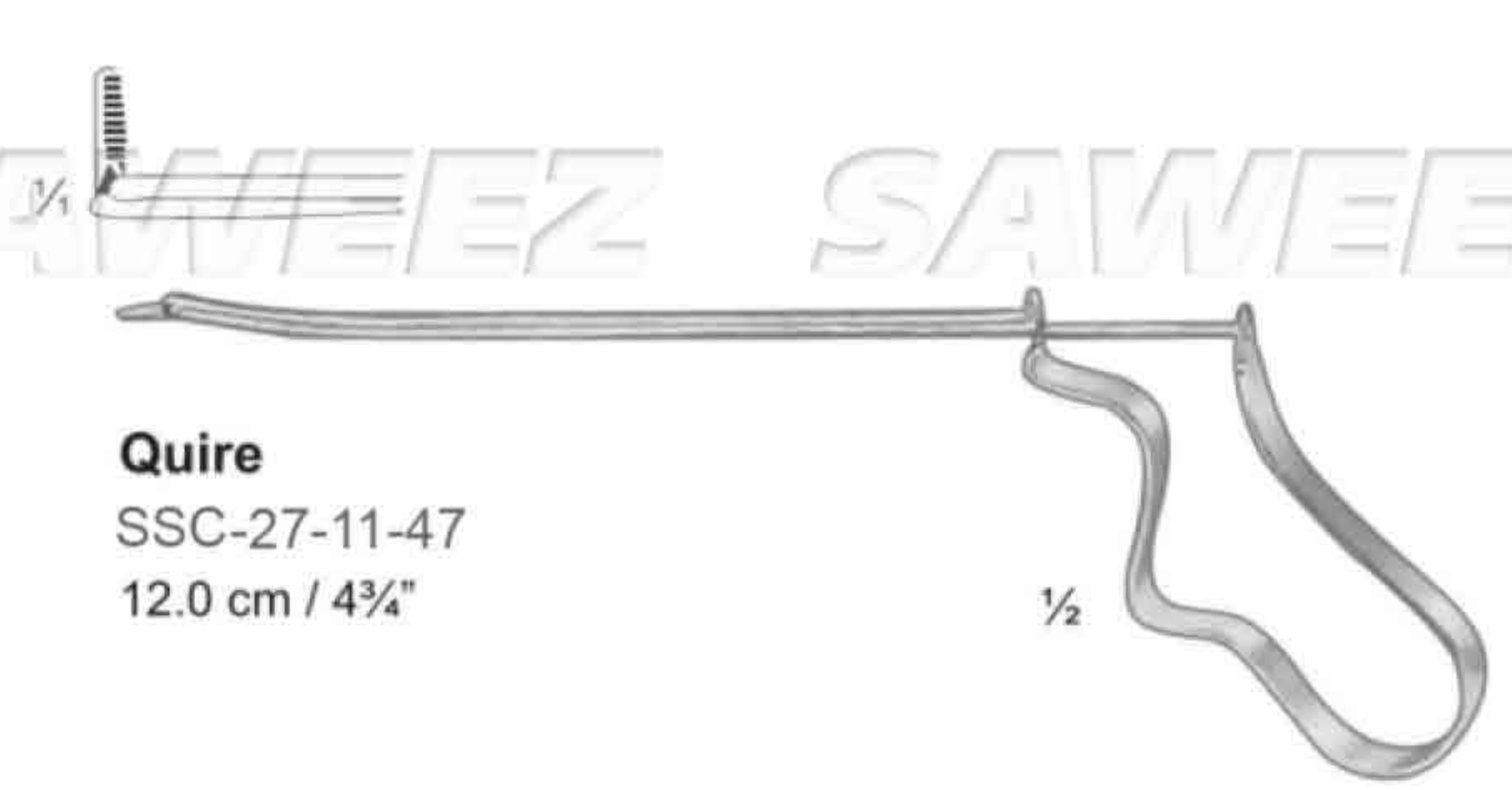
SSC-27-11-49



SSC-27-11-50



SSC-27-11-51



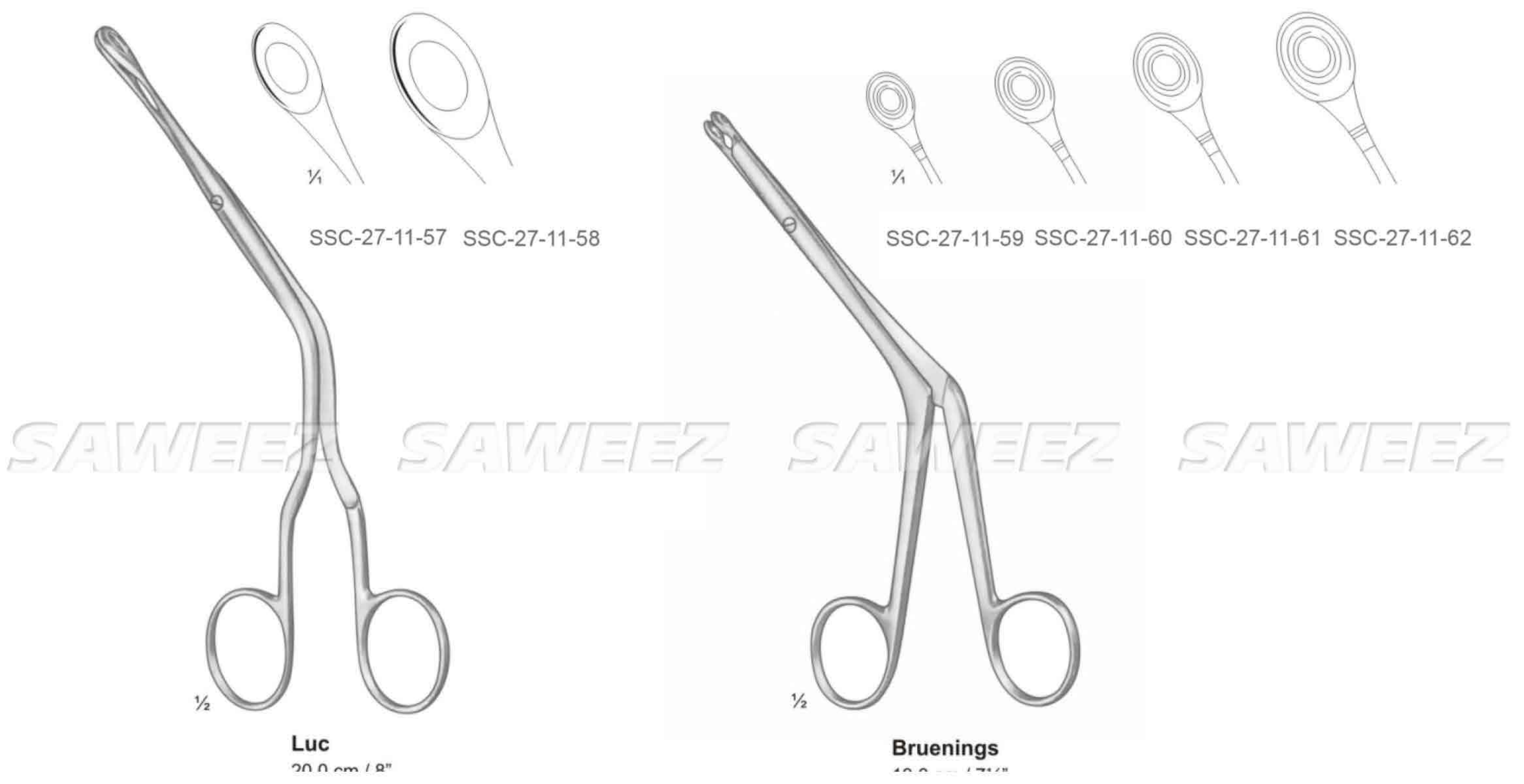
Quire
SSC-27-11-47
12.0 cm / 4 3/4"

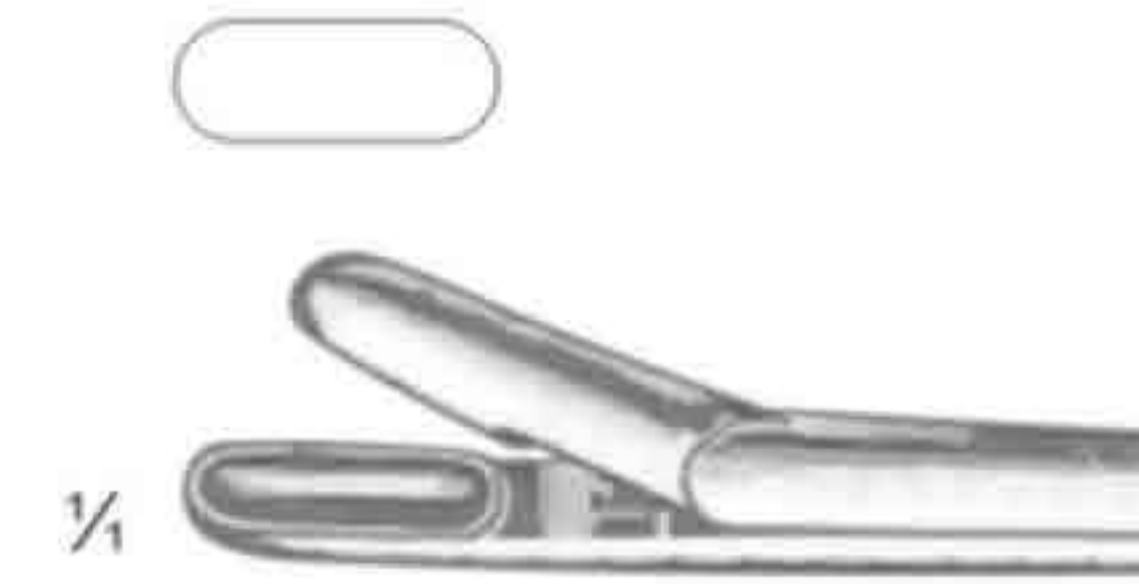


Heymann
18.0 cm / 7"



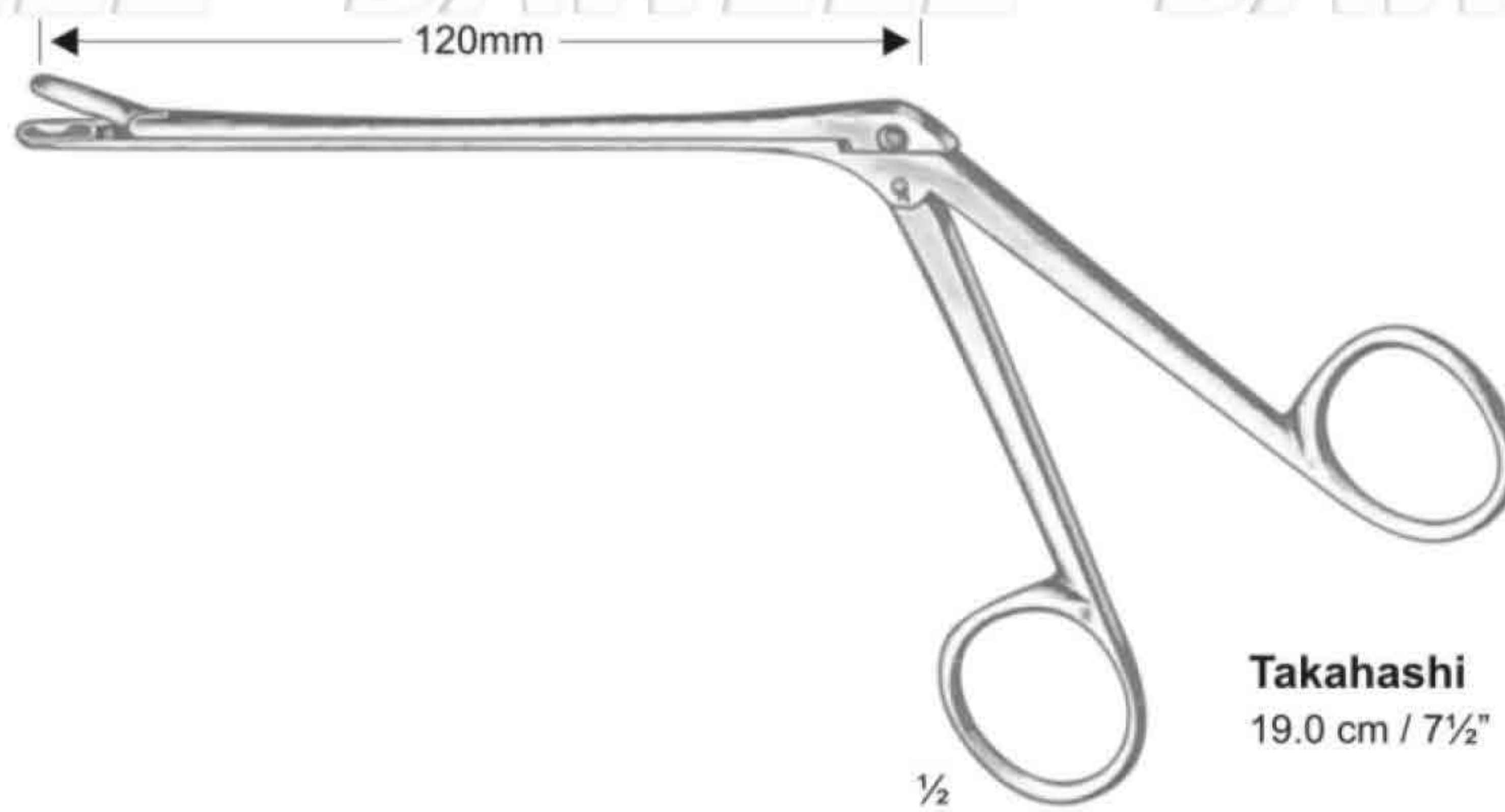
Knight
18.0 cm / 7"





SSC-27-11-63

SAWEEZ SAWEEZ SAWEEZ SAWEEZ



Takahashi
19.0 cm / 7½"

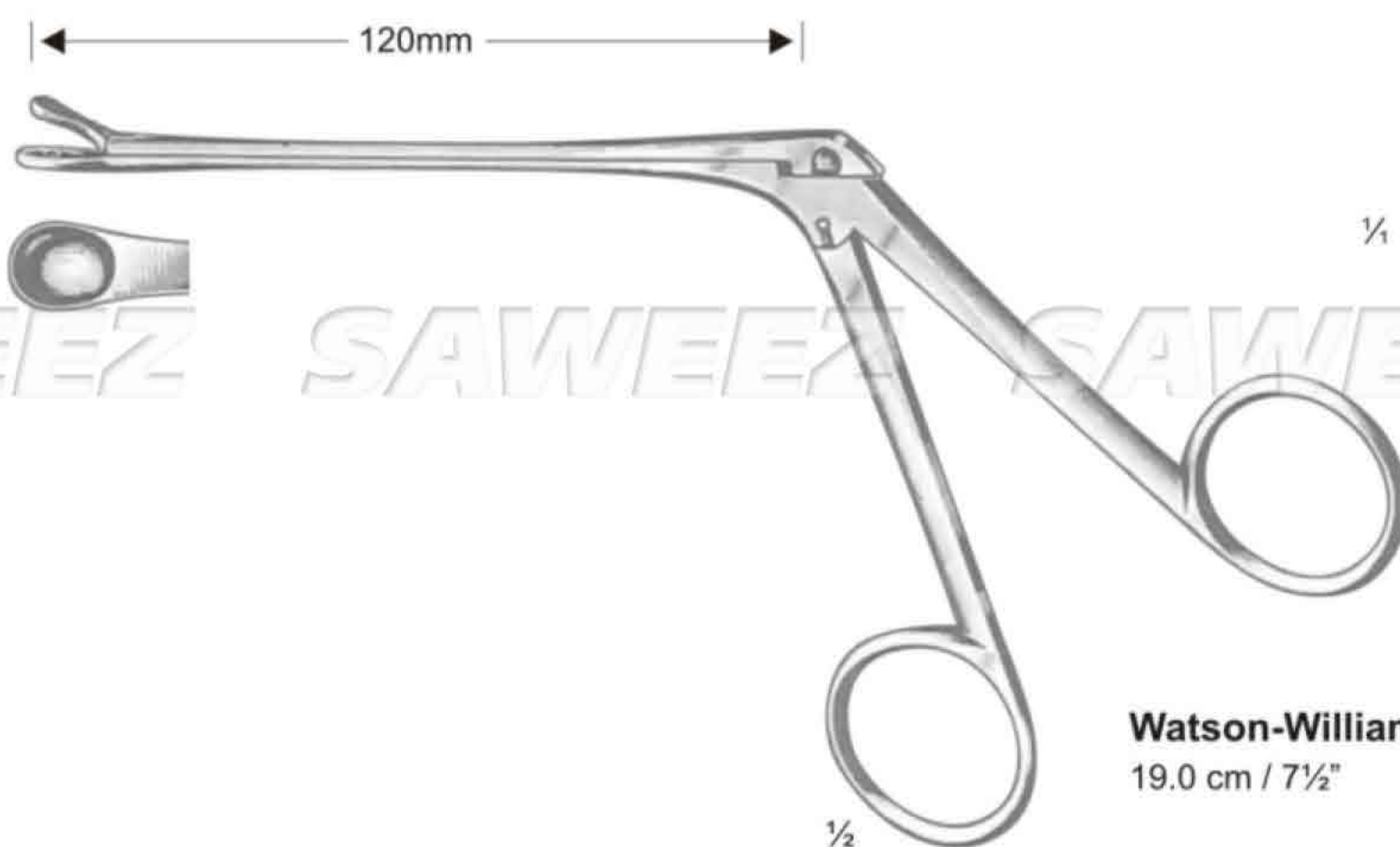


SSC-27-11-64

SAWEEZ SAWEEZ SAWEEZ SAWEEZ



Weil
SSC-27-11-65



Watson-Williams
19.0 cm / 7½"



SSC-27-11-66

SAWEEZ SAWEEZ SAWEEZ SAWEEZ



without neck



SSC-27-11-67



SSC-27-11-68



SSC-27-11-69



SSC-27-11-70



SSC-27-11-71



with neck



SSC-27-11-72



SSC-27-11-73



SSC-27-11-74

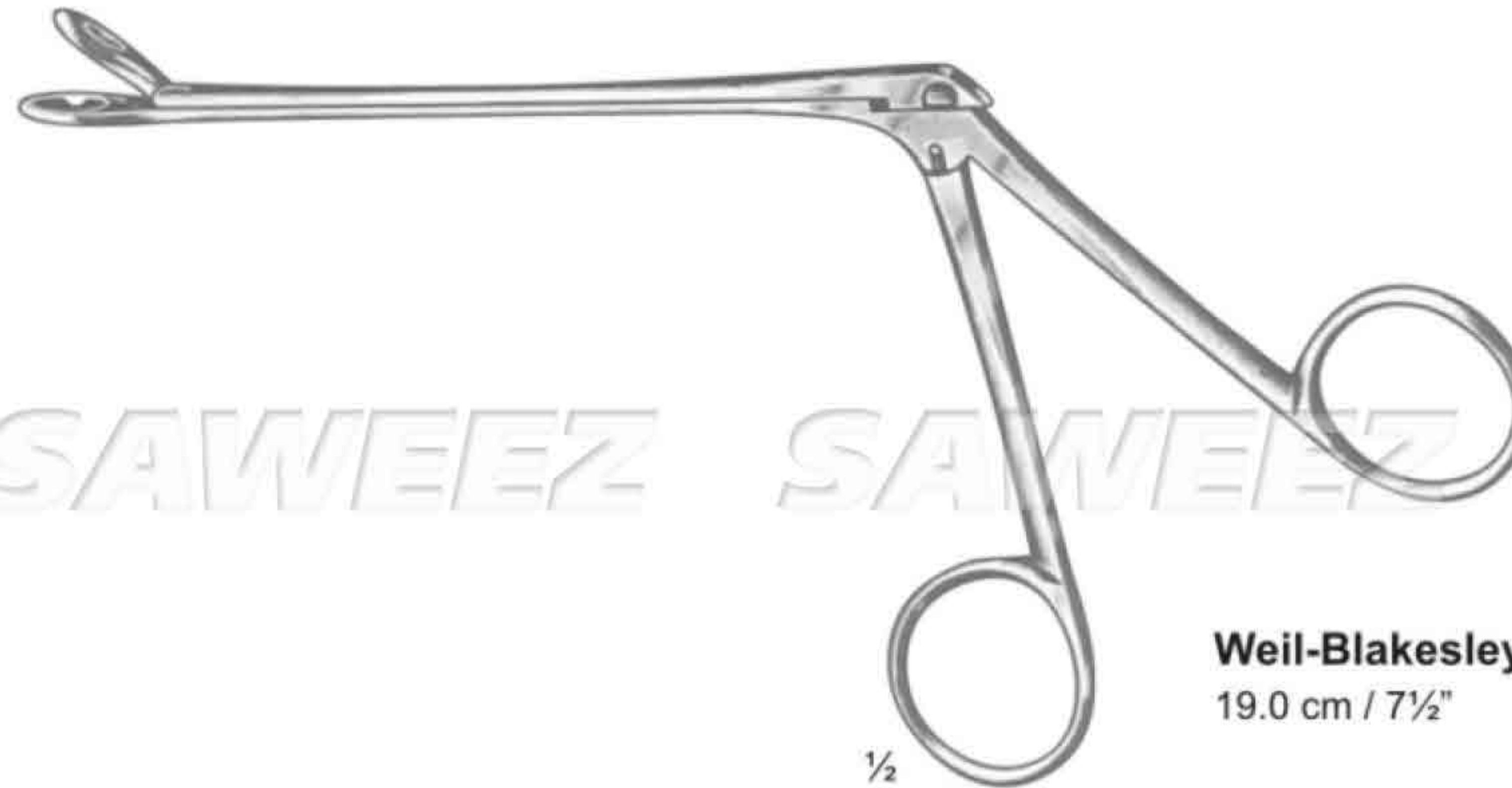


SSC-27-11-75



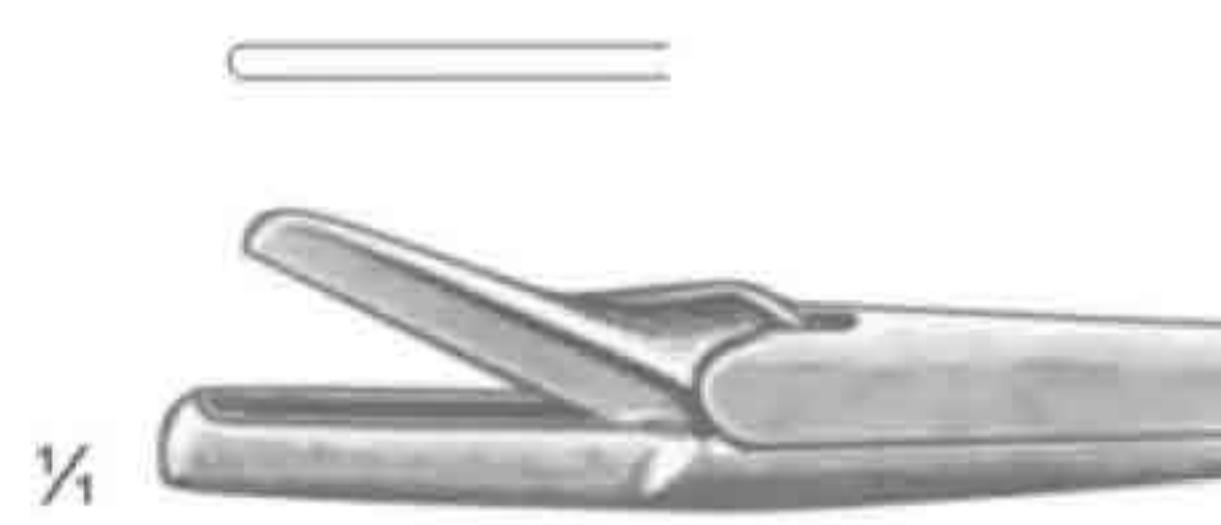
SSC-27-11-76

120mm

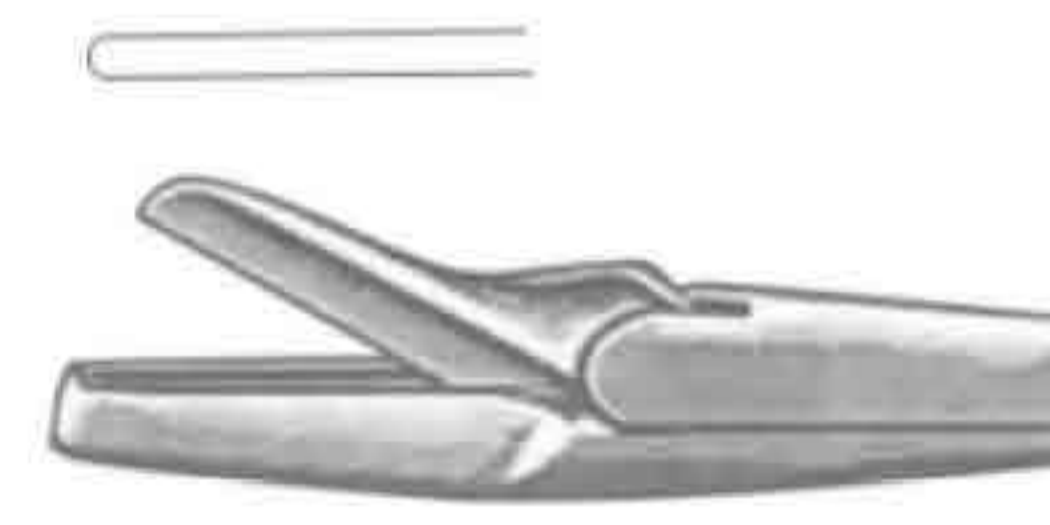


Weil-Blakesley
19.0 cm / 7½"

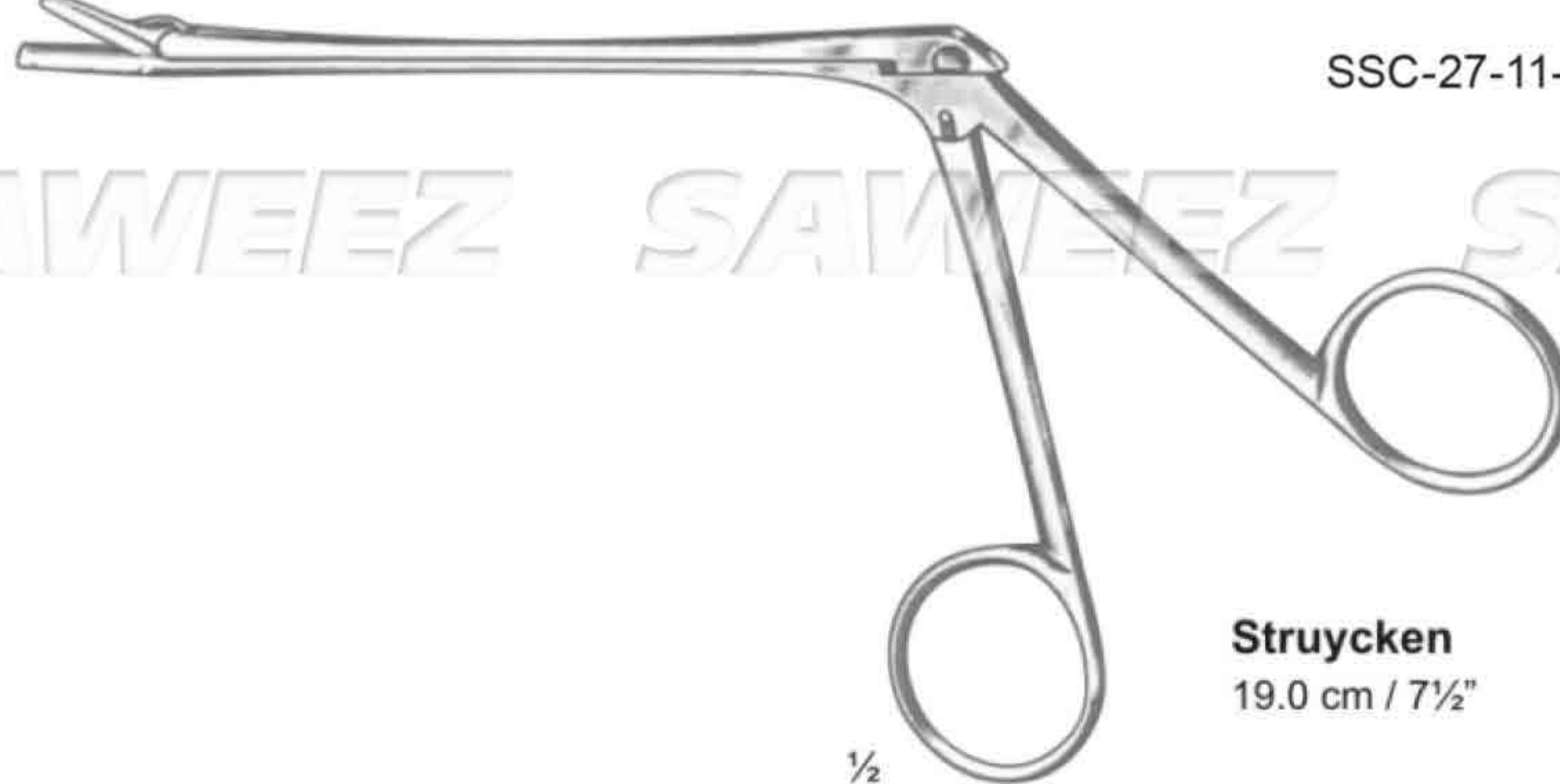
120mm



SSC-27-11-77



SSC-27-11-78



Struycken
19.0 cm / 7½"



SSC-27-11-79
2.2mm

SSC-27-11-80
2.6mm

SSC-27-11-81
3.0mm

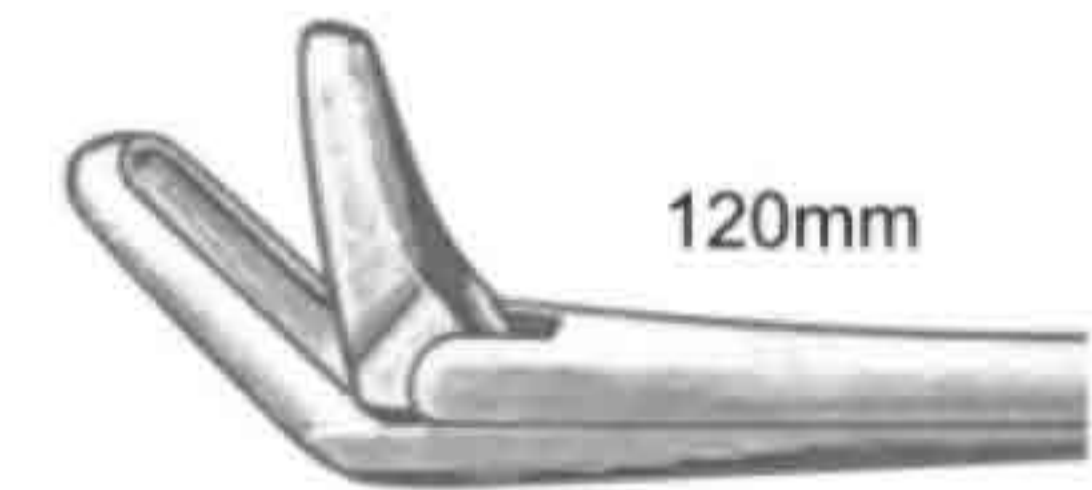
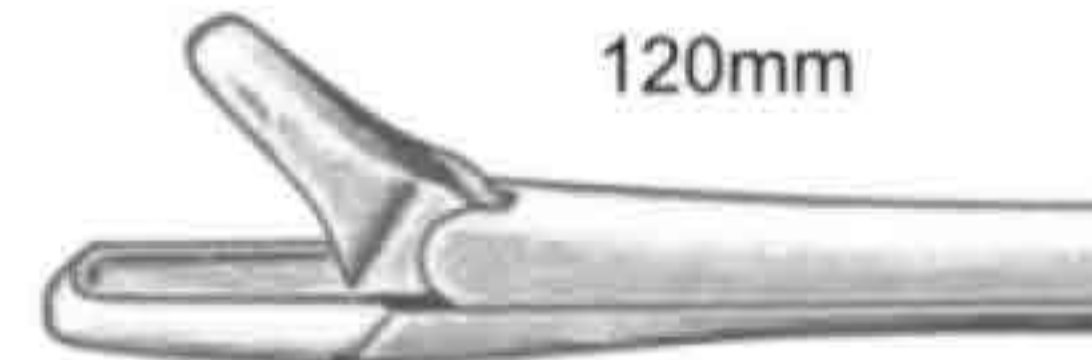
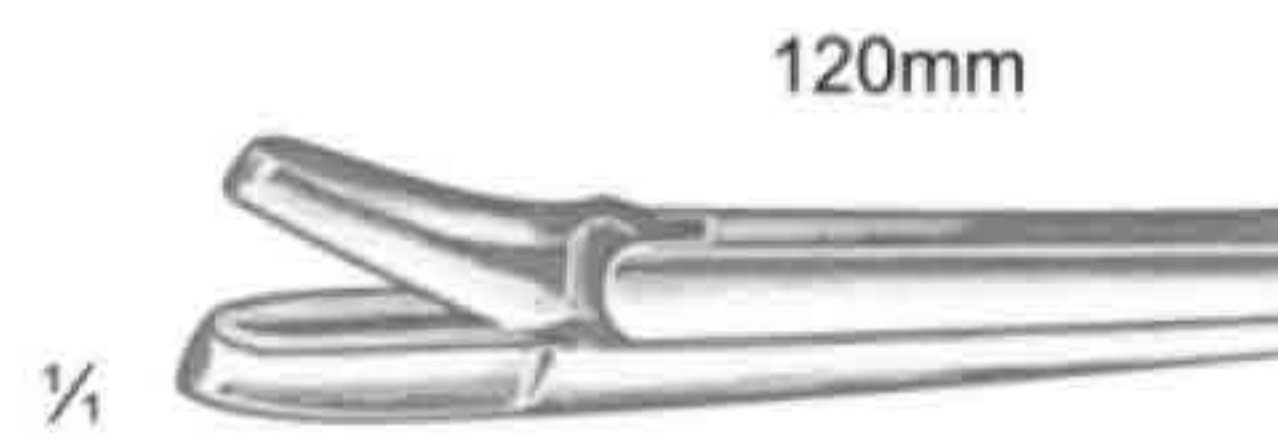
SSC-27-11-82
3.4mm

SSC-27-11-83

SSC-27-11-84

SSC-27-11-85

SSC-27-11-86



Myles
19.0 cm / 7½"

19.0 cm / 7½"

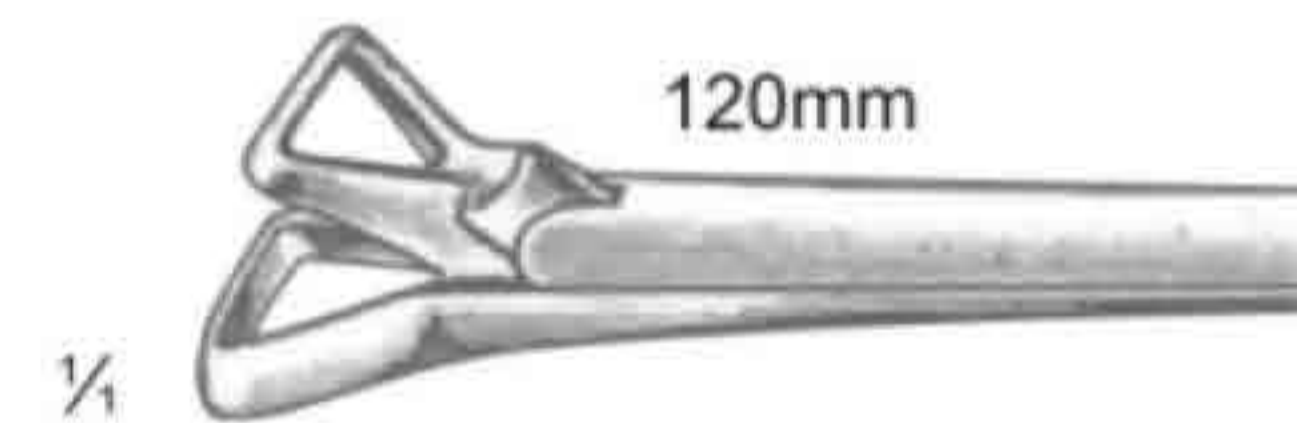
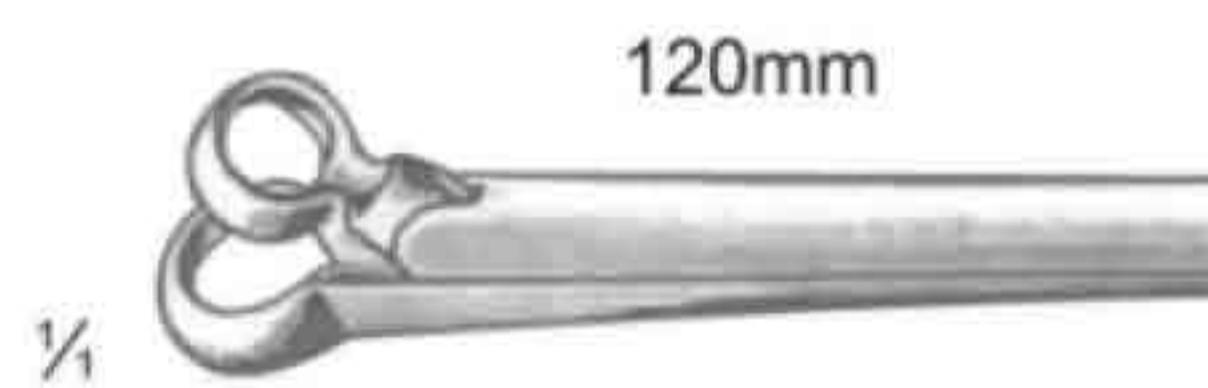
SSC-27-11-87
5.0mm

SSC-27-11-88
7.0mm

SSC-27-11-89
9.0mm

SSC-27-11-90
11.0mm

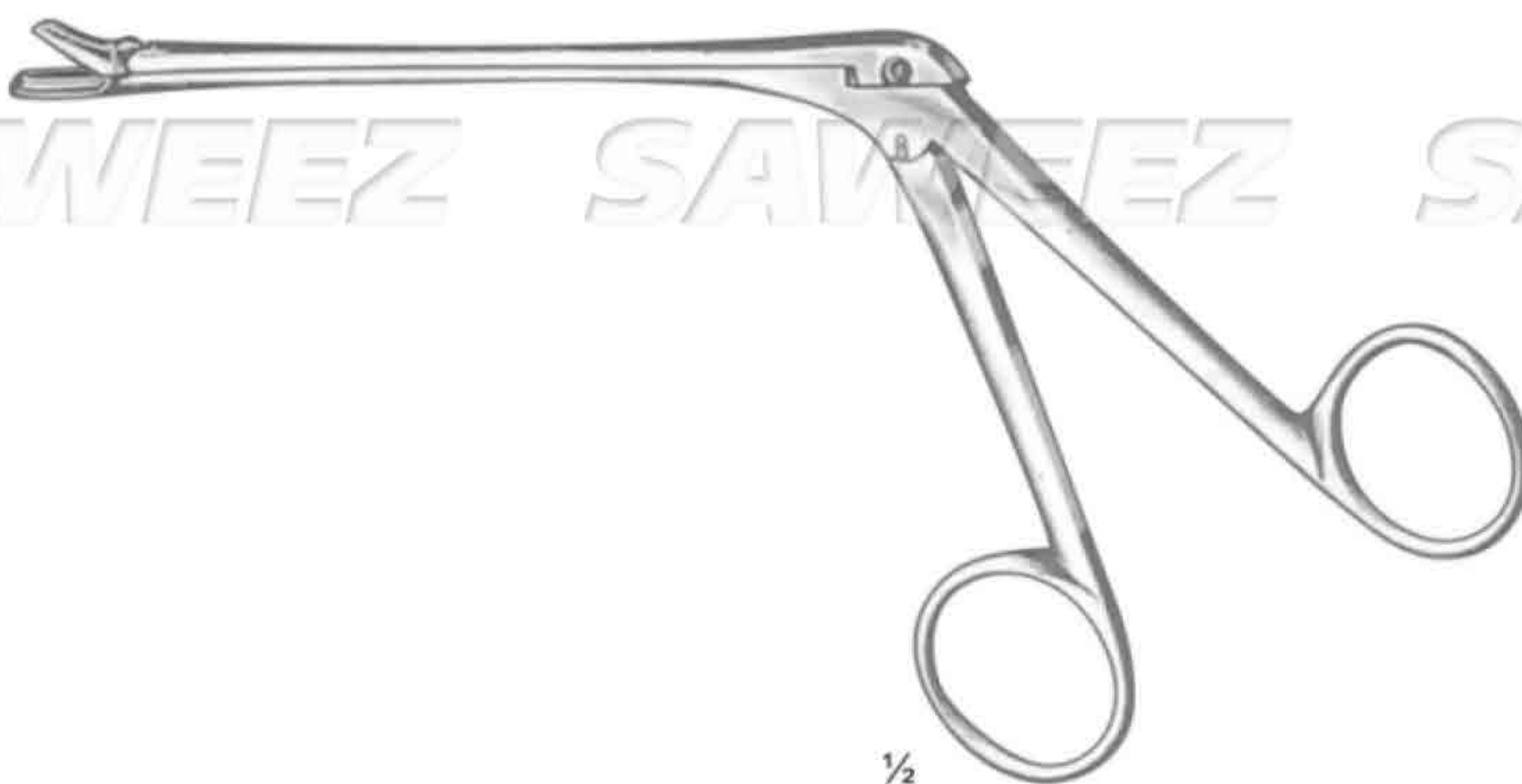
SSC-27-11-91



Hartmann
19.0 cm / 7½"

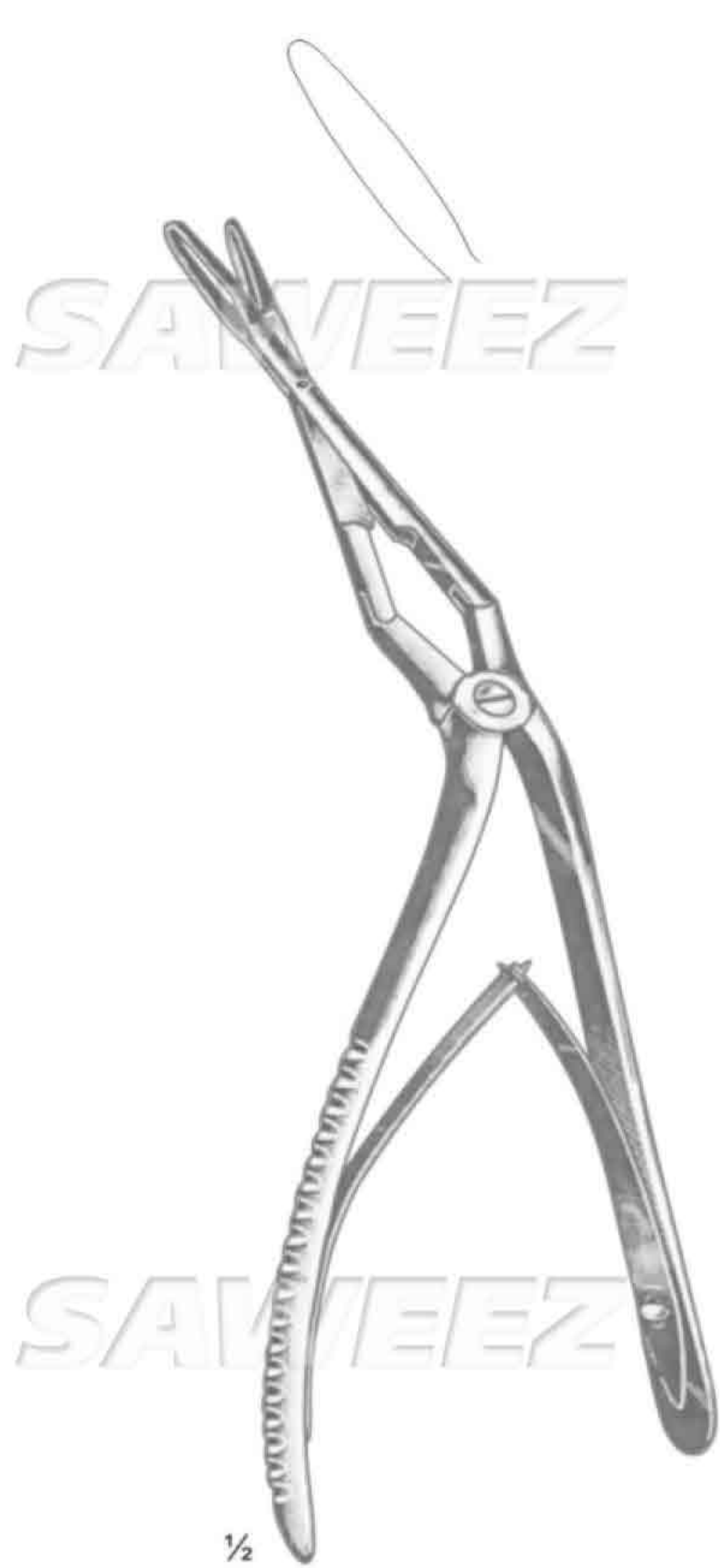
Schmeden
19.0 cm / 7½"

120mm





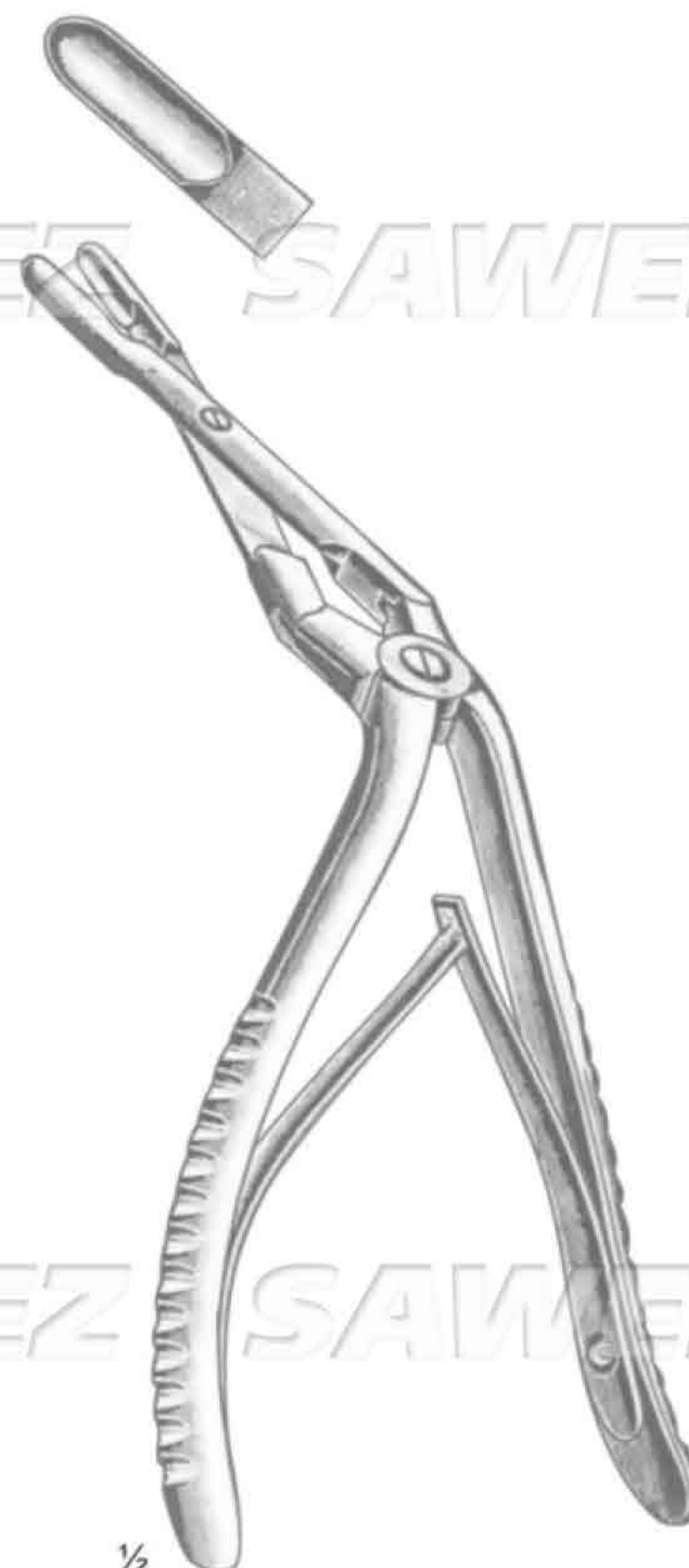
SAWEEZ SAWEEZ SAWEEZ SAWEEZ



Jansen-Struycken
SSC-27-11-92
19.0 cm / 7½"



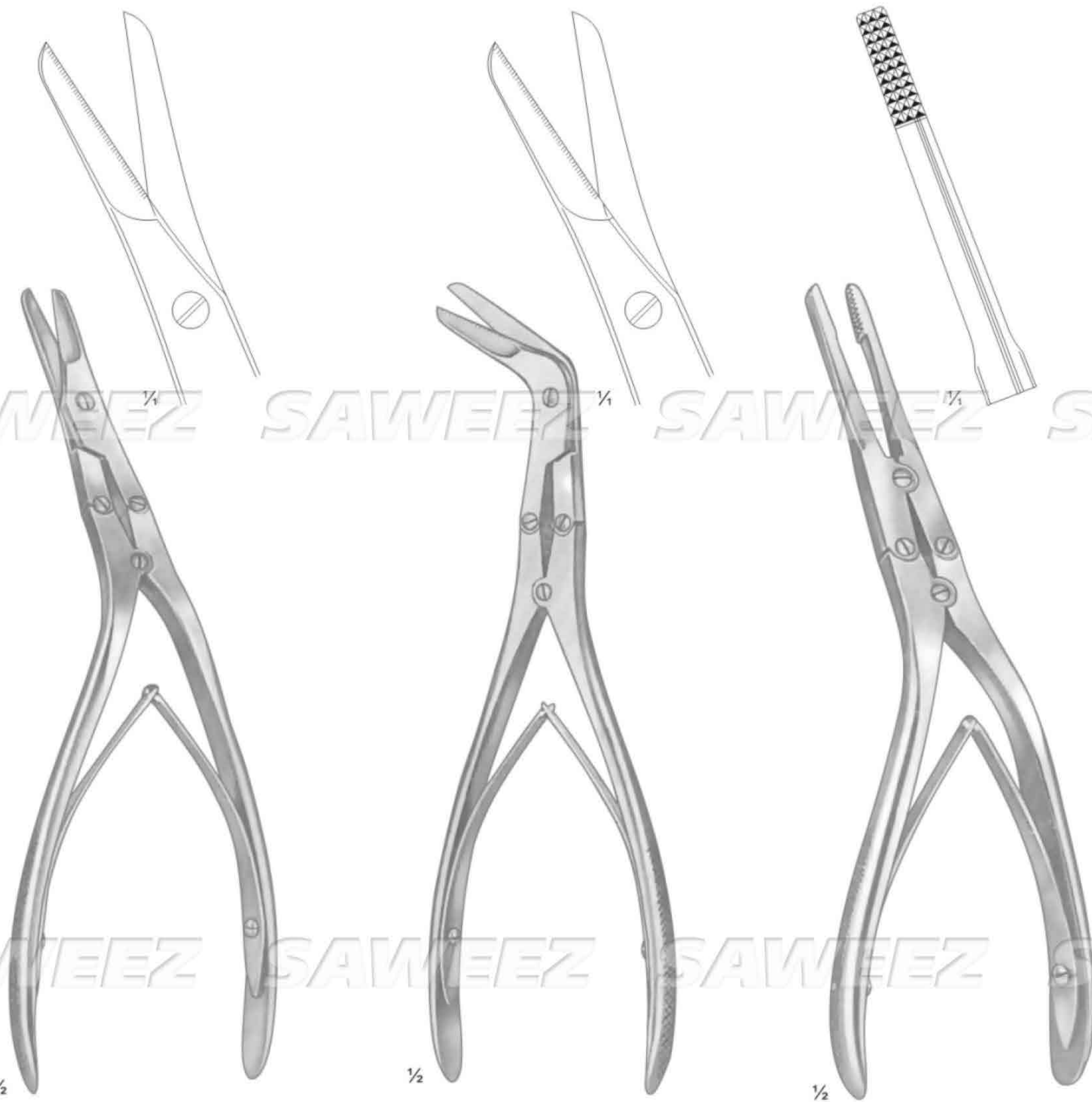
Middleton-Jansen
SSC-27-11-93
19.0 cm / 7½"



Middleton-Jansen
SSC-27-11-94
19.0 cm / 7½"

SAWEEZ SAWEEZ SAWEEZ SAWEEZ

SAWEEZ SAWEEZ SAWEEZ SAWEEZ



SSC-27-11-98

Caplan
SSC-27-11-95
20.0 cm / 8"

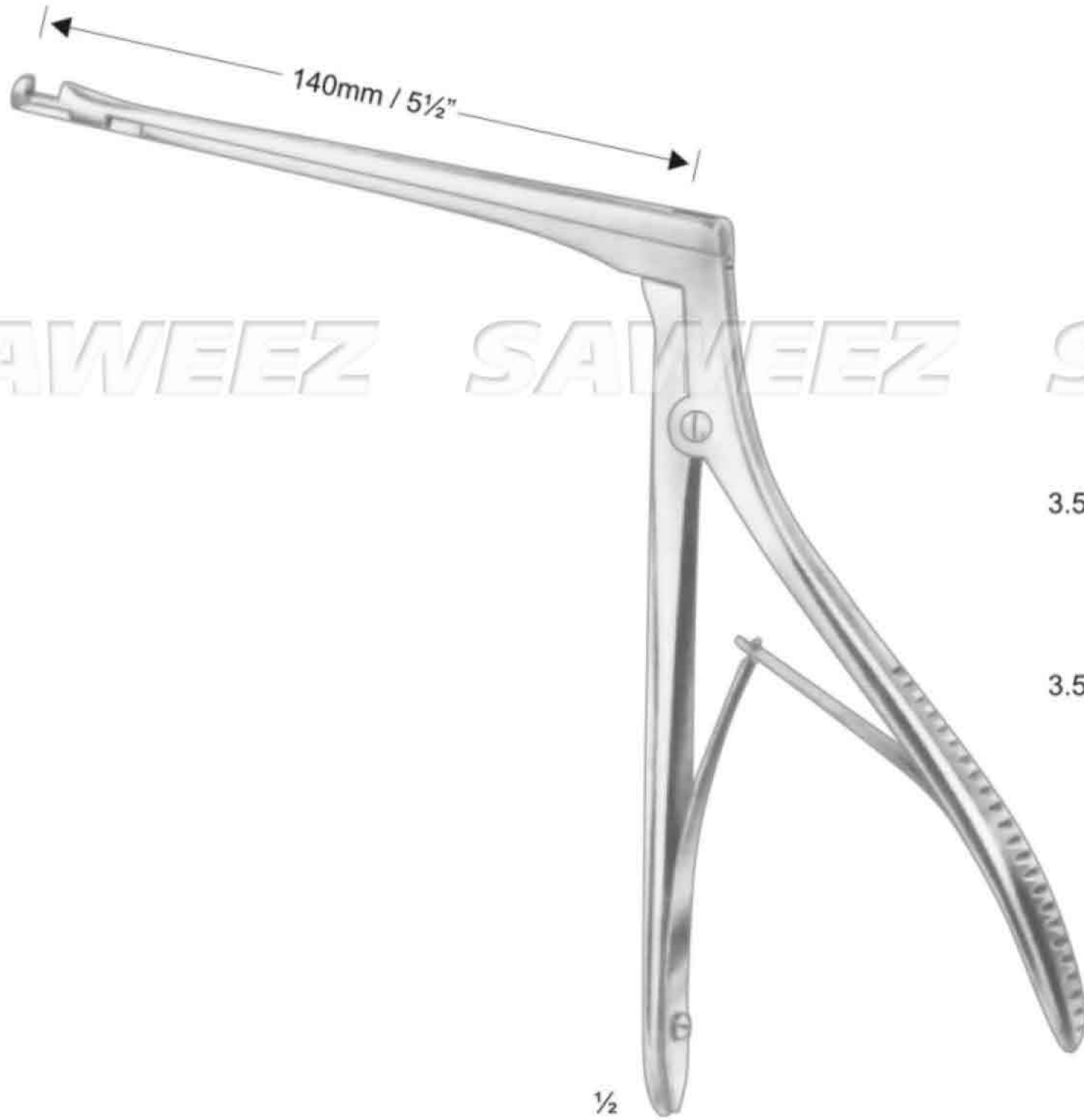
Septum scissors serrated


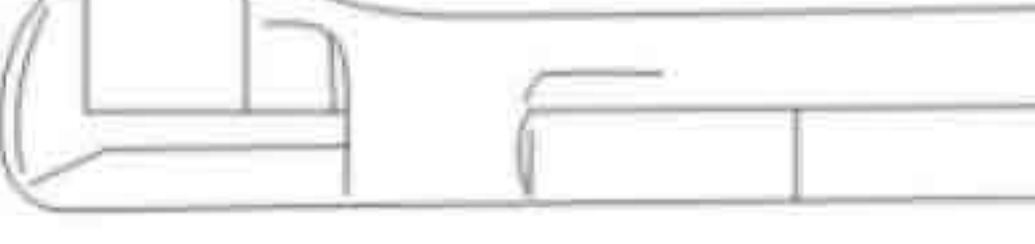
Killian
SSC-27-11-96
21.0 cm / 8½"



Septum scissors serrated


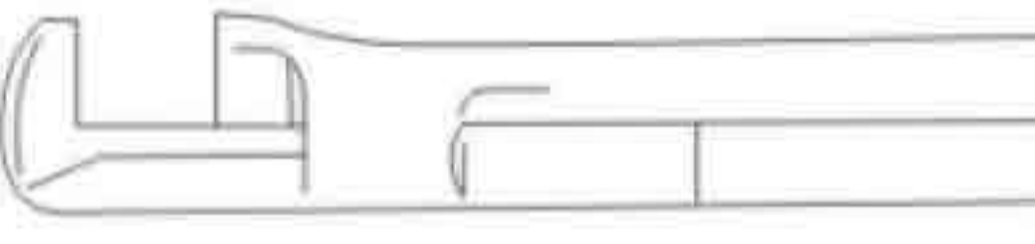
Rubin
SSC-27-11-97
21.0 cm / 8½"


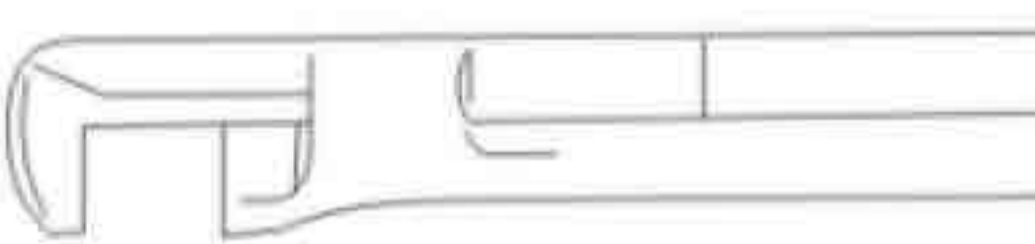
Septum morselizer



4 x 4mm   **Hajek**
SSC-27-11-99

4 x 4mm   **Hajek**
SSC-27-12-00

3.5 x 3.5 mm   **Hajek-Kofler**
SSC-27-12-01



3.5 x 3.5 mm   **Hajek-Kofler**
SSC-27-12-02

3 x 5mm   SSC-27-12-03

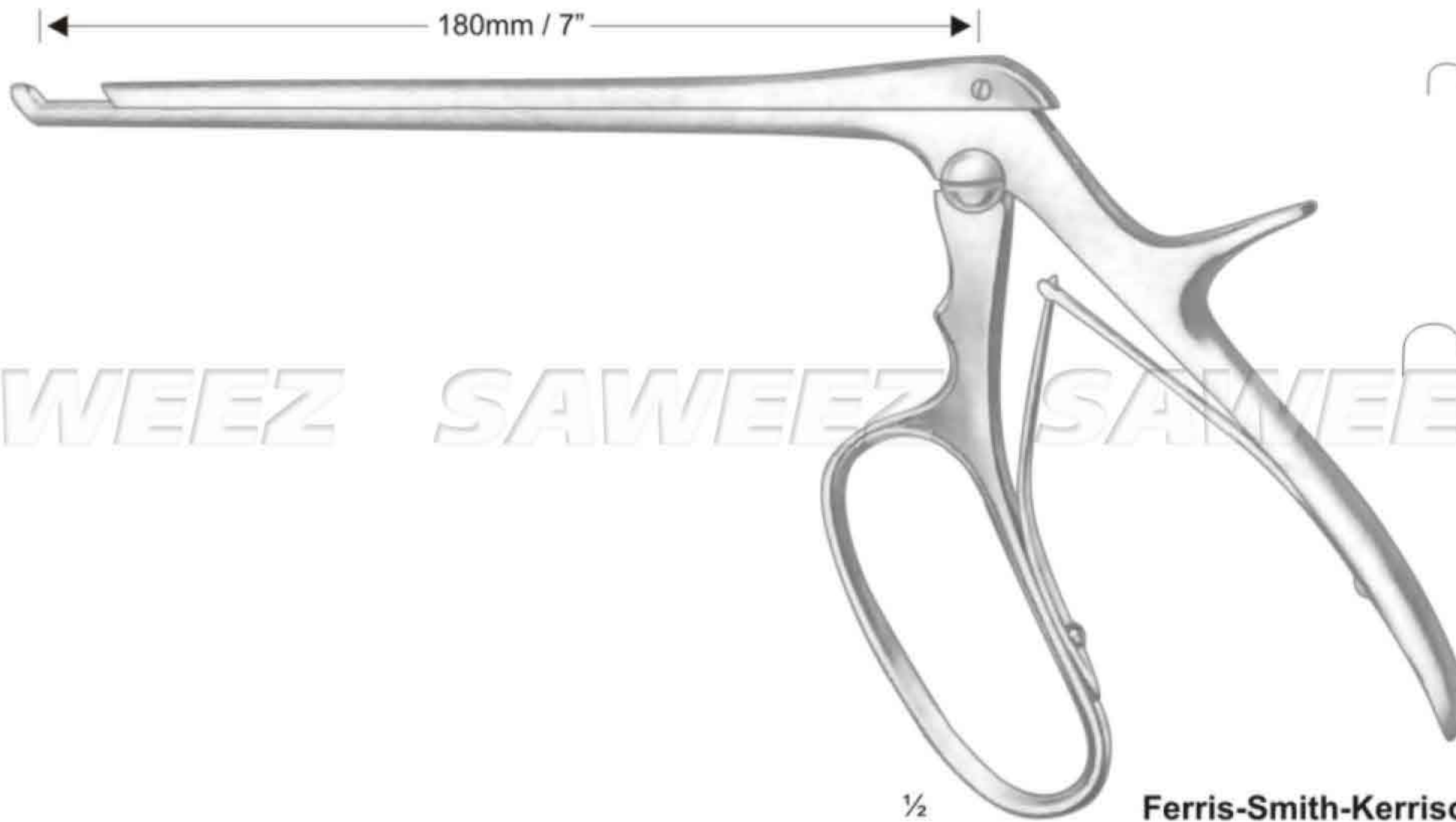
3 x 5mm   SSC-27-12-04



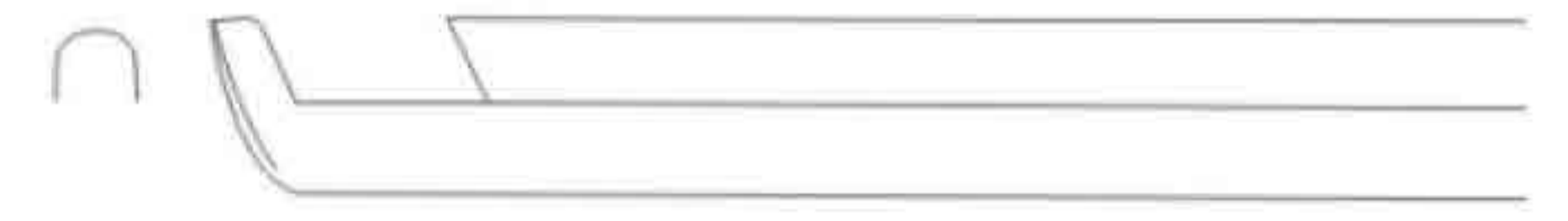
5 x 5mm   SSC-27-12-05

5 x 5mm   SSC-27-12-06

Ferris-Smith-Kerrison
18.0 cm / 7" shaft



**Ferris-Smith-Kerrison
(Cloward Harper)**
18.0 cm / 7" shaft



SSC-27-12-07 = 3 mm



SSC-27-12-08 = 5 mm

SAWEEZ SAWEEZ SAWEEZ SAWEEZ

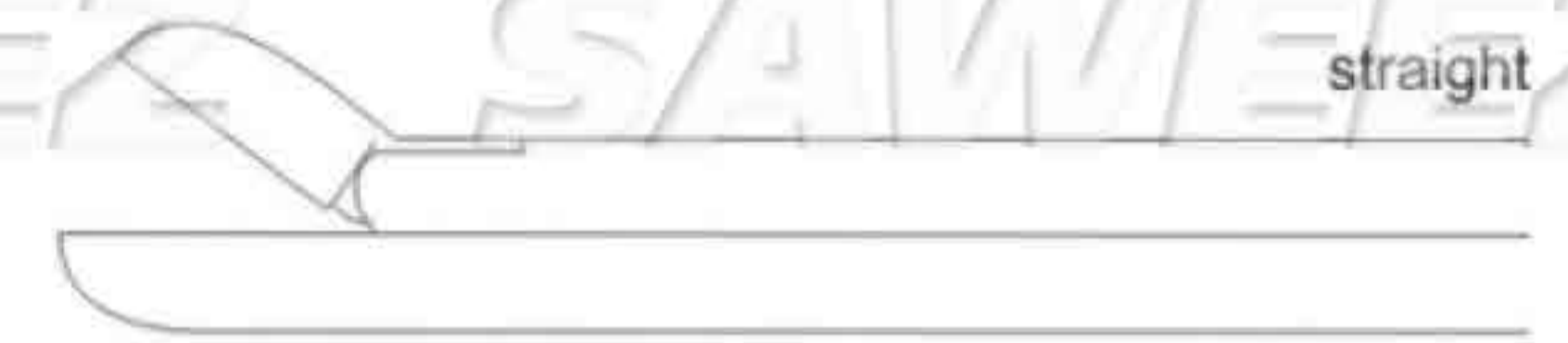
SAWEEZ SAWEEZ SAWEEZ SAWEEZ








curved up

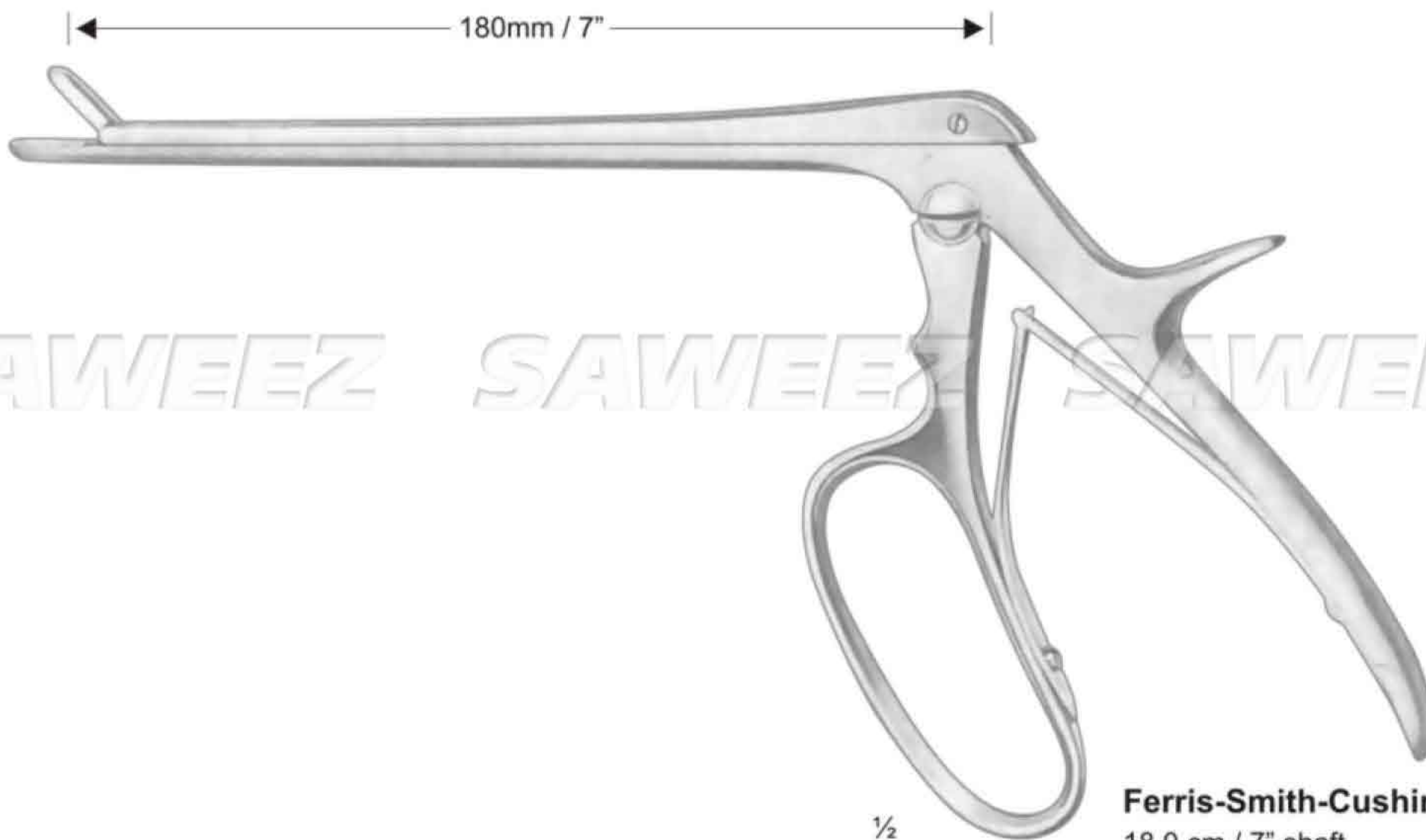
1/4

-  SSC-27-12-09 = 2 x 10 mm
-  SSC-27-12-10 = 3 x 10 mm
-  SSC-27-12-11 = 4 x 10 mm



straight


-  SSC-27-12-12 = 2 x 10 mm
-  SSC-27-12-13 = 3 x 10 mm
-  SSC-27-12-14 = 4 x 10 mm
-  SSC-27-12-15 = 5 x 10 mm
-  SSC-27-12-16 = 6 x 10 mm



Ferris-Smith-Cushing
18.0 cm / 7" shaft



curved down

-  SSC-27-12-17 = 2 x 10 mm
-  SSC-27-12-18 = 3 x 10 mm
-  SSC-27-12-19 = 4 x 10 mm

SAWEEZ SAWEEZ SAWEEZ SAWEEZ

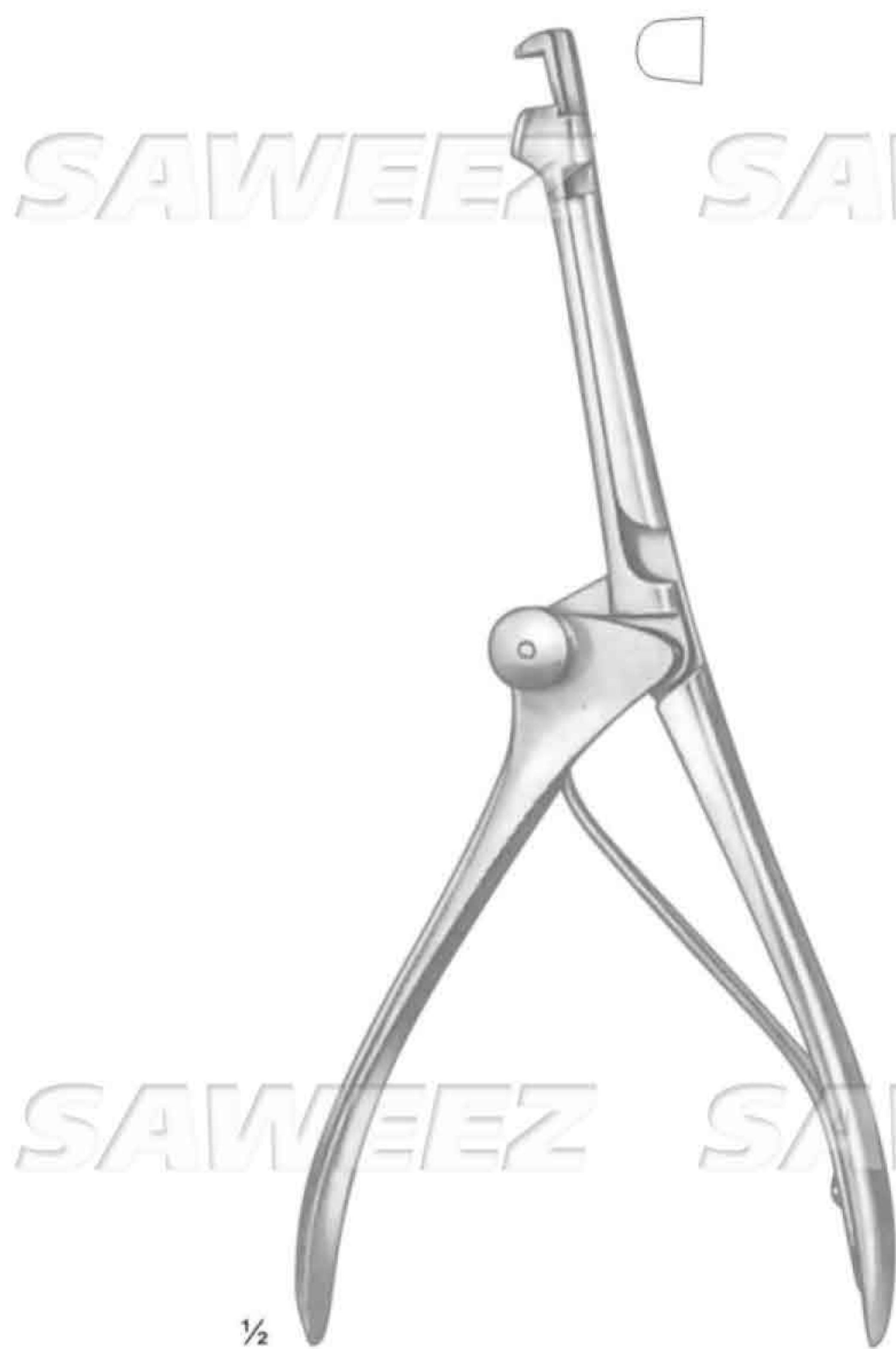


SAWEEZ SAWEEZ SAWEEZ SAWEEZ

4 x 4 mm  SSC-27-12-20 = 4 mm

5 x 5 mm  SSC-27-12-21 = 5 mm

6 x 6 mm  SSC-27-12-22 = 6 mm



Hajek-Claus
SSC-27-12-23
20.0 cm / 8"



Kerrison
20.0 cm / 8"

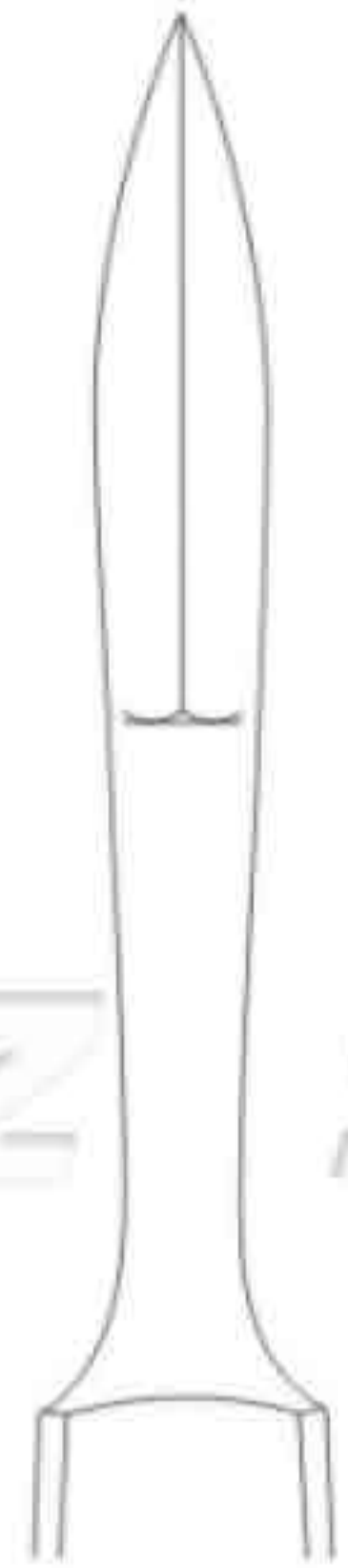
SAWEEZ SAWEEZ SAWEEZ SAWEEZ



Joseph

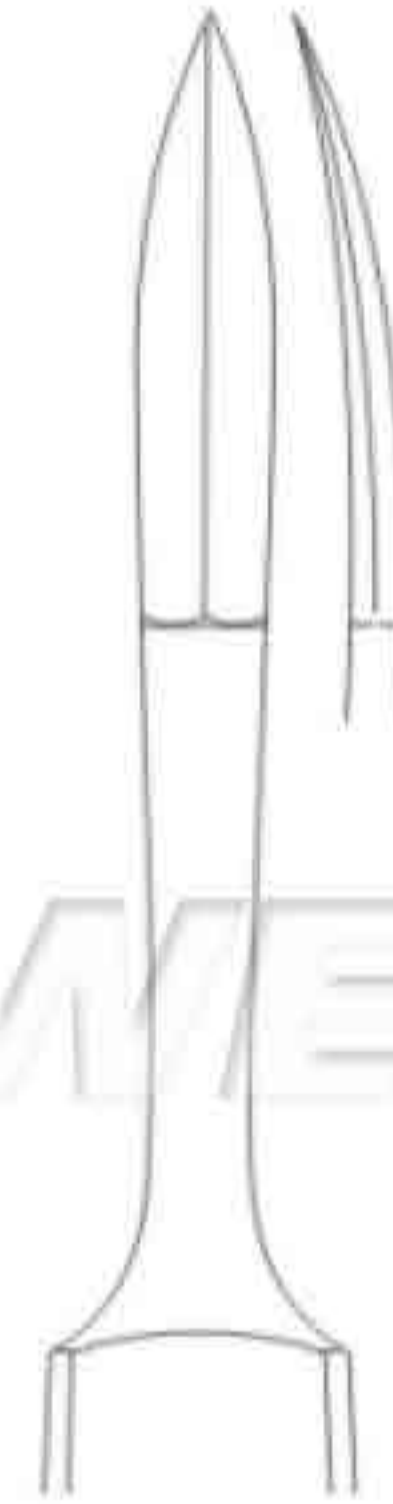


SSC-27-12-24



SSC-27-12-25

Straight

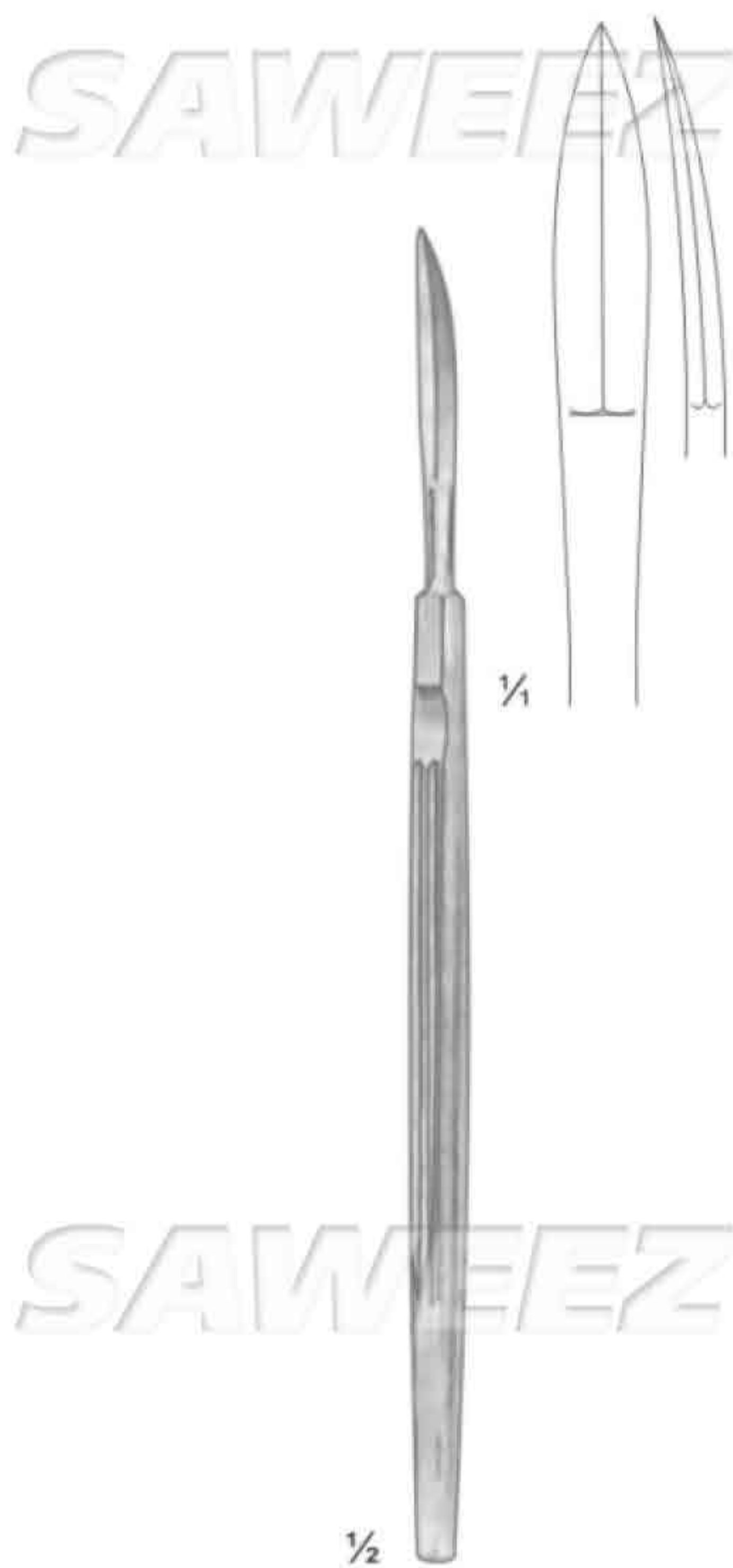


SSC-27-12-26

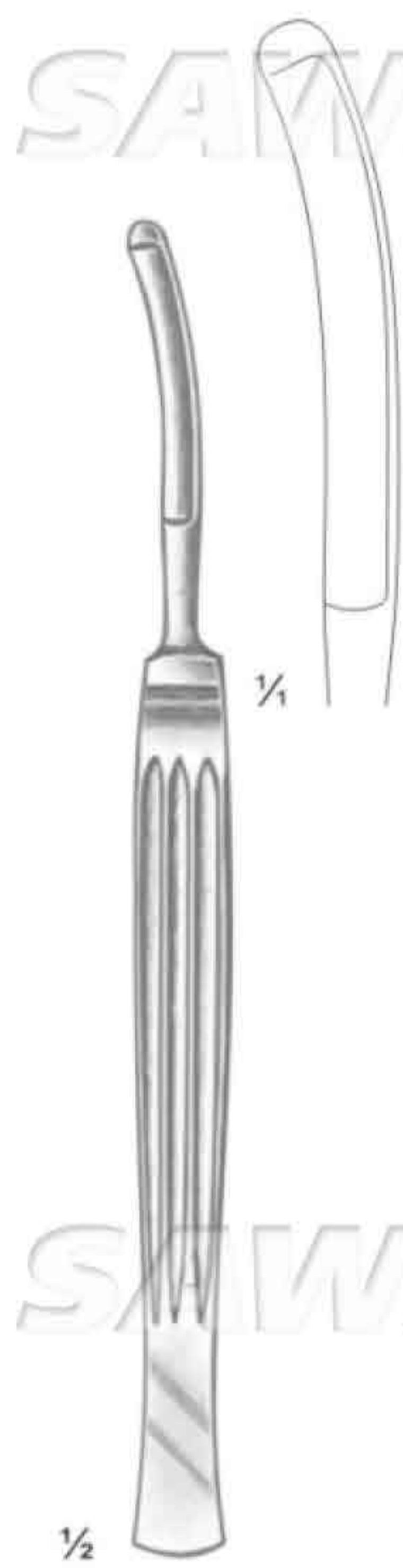
Curved



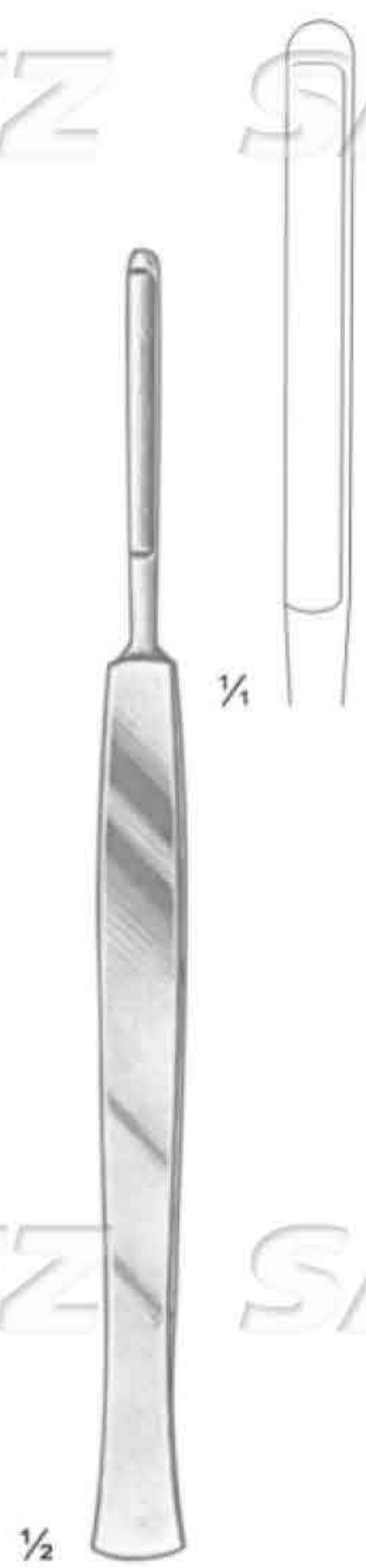
SSC-27-12-27



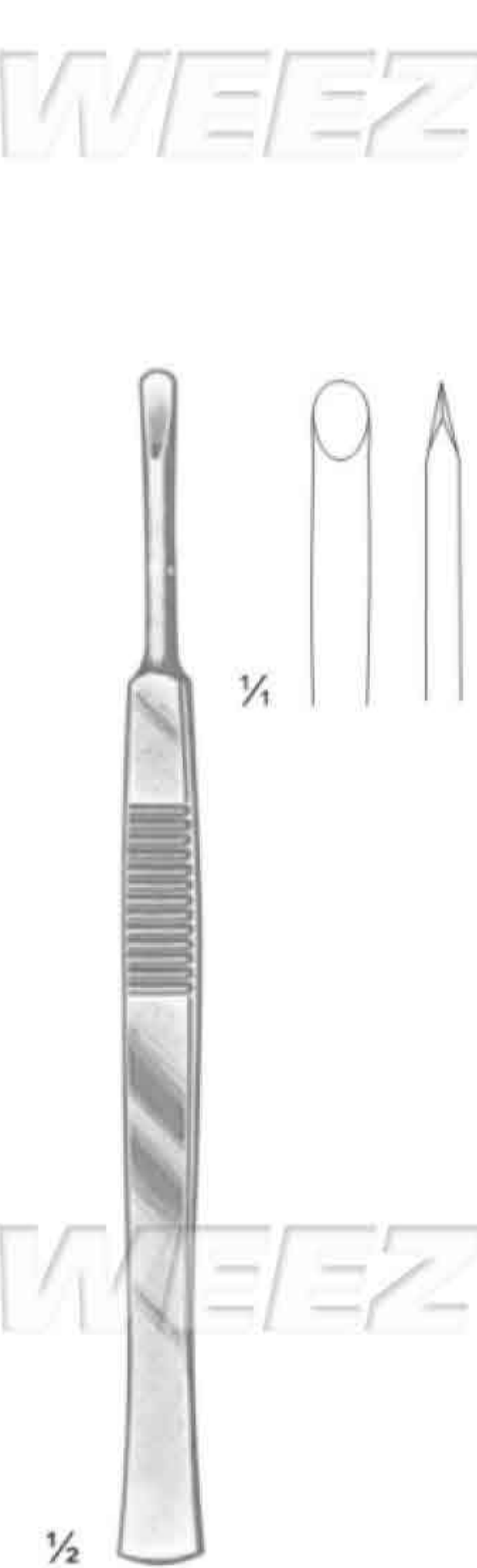
Fomon
SSC-27-12-28
16.0 cm / 6 1/4"



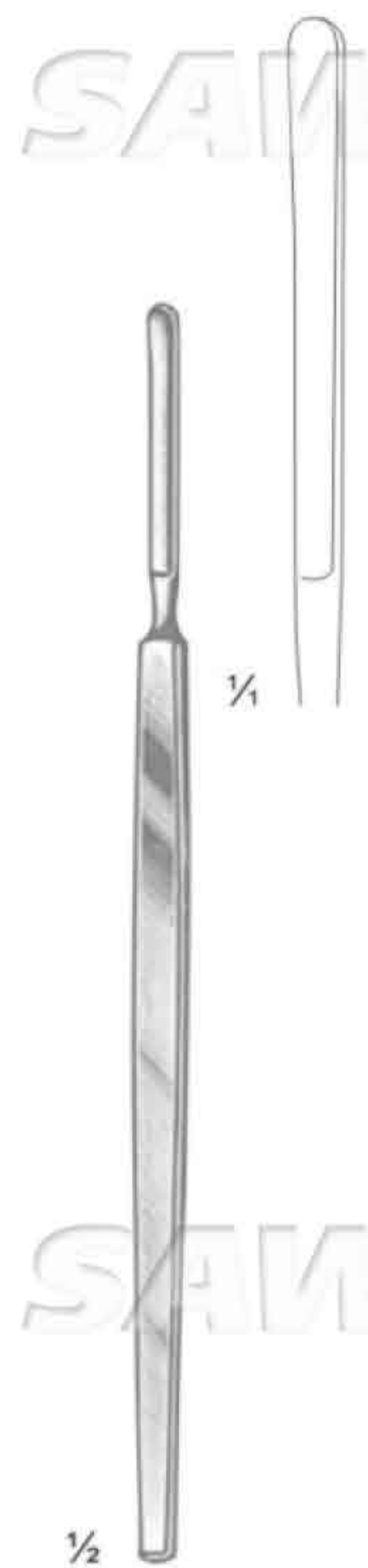
Converse
SSC-27-12-29
16.0 cm / 6 1/4"



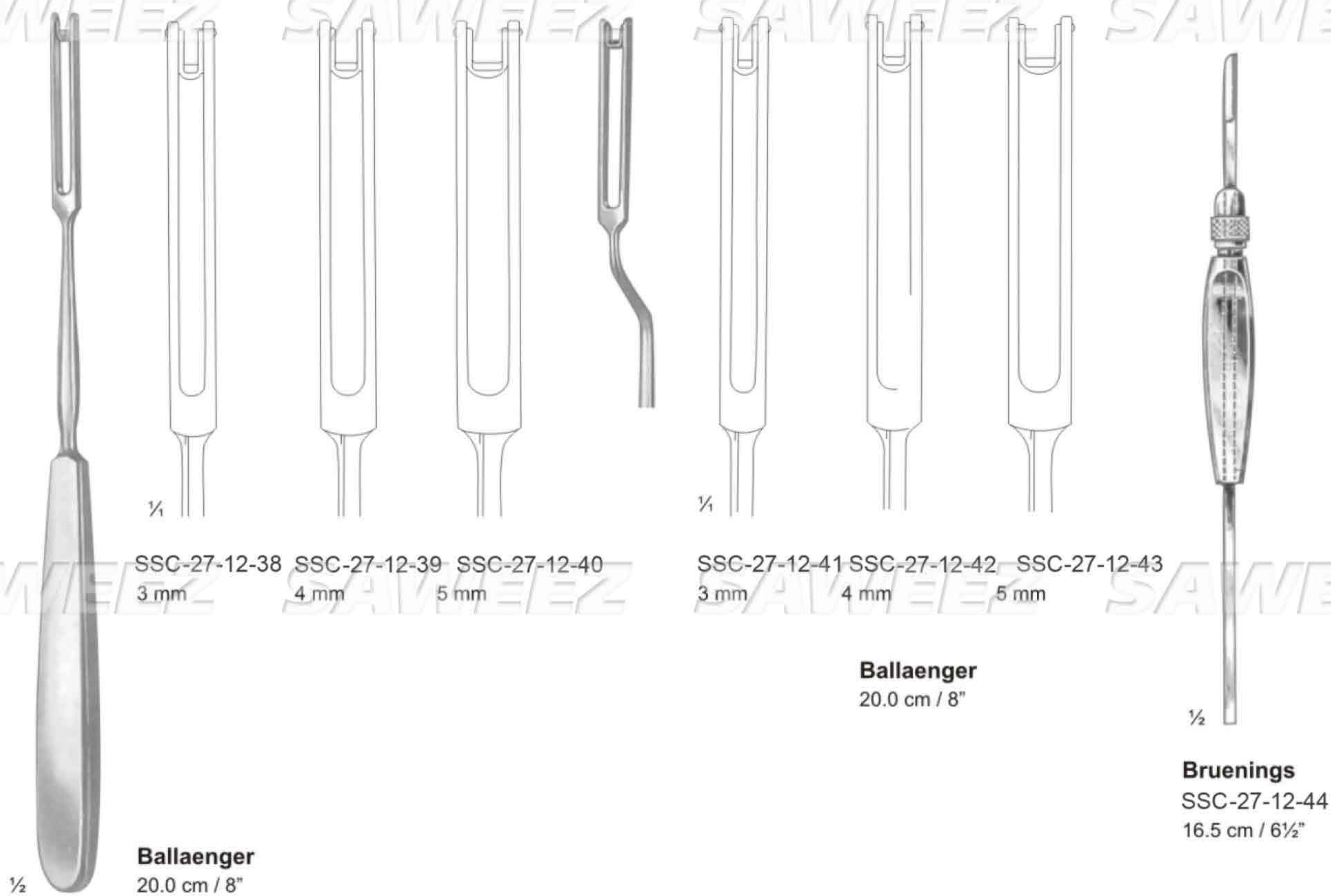
Joseph
SSC-27-12-30
15 cm / 6"



Cottle
SSC-27-12-31
15.0 cm / 6"



Cottle
SSC-27-12-32
15.0 cm / 6"





Mckenty

SSC-27-12-45
4 mm

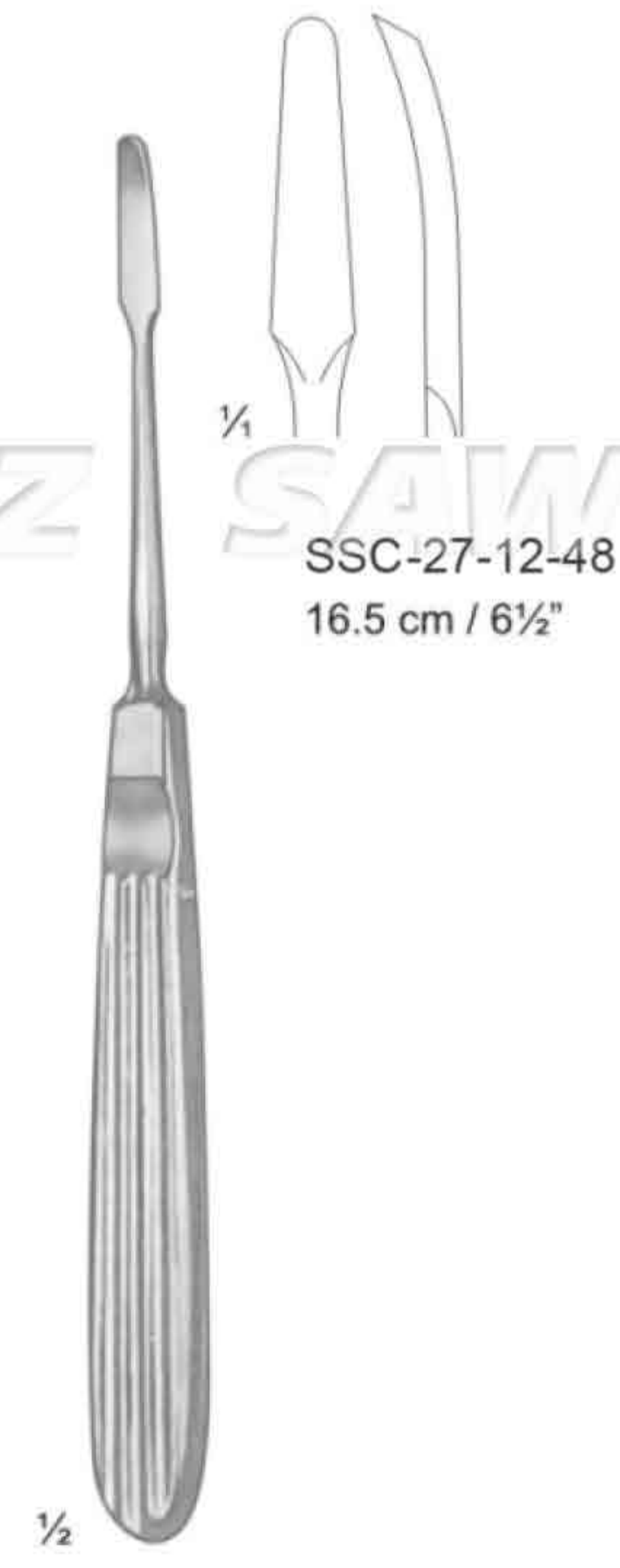


SSC-27-12-46
5 mm



Halle

SSC-27-12-47
16.5 cm / 6 1/2"



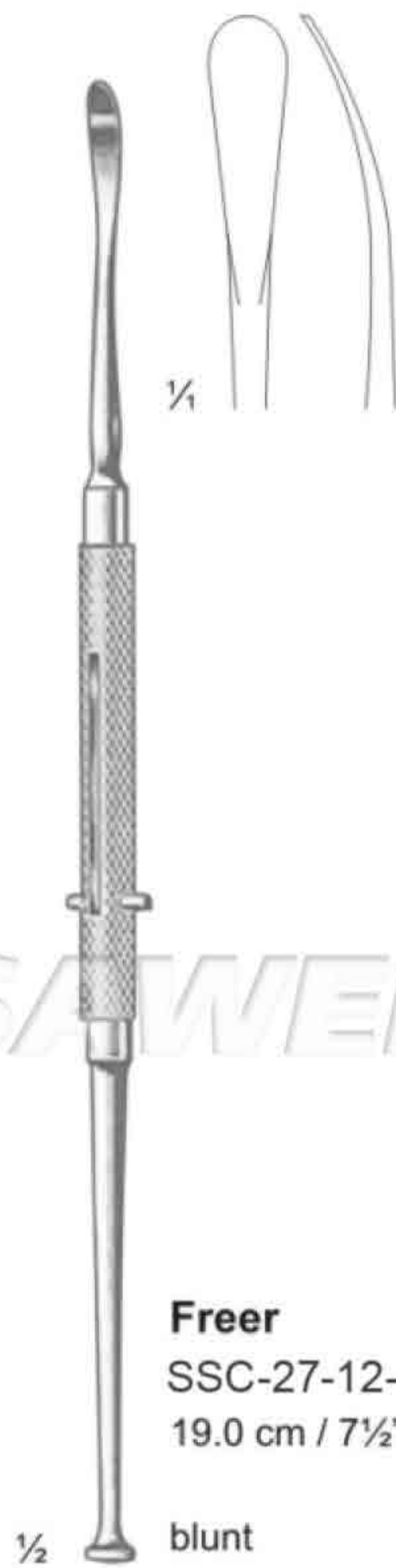
Joseph

SSC-27-12-48
16.5 cm / 6 1/2"



Freer
SSC-27-12-49
19.0 cm / 7 1/2"

sharp



Freer
SSC-27-12-50
19.0 cm / 7 1/2"

blunt



Freer
SSC-27-12-51
18.0 cm / 7"

sharp-blunt



Freer
SSC-27-12-52
20.5 cm / 8"

Blunt



SAWEEZ SAWEEZ SAWEEZ SAWEEZ



Mckenty
SSC-27-12-53
22.0 cm / 8 3/4"

Cottle
SSC-27-12-54
23.0 cm / 9"

Killan
SSC-27-12-55
18.0 cm / 7"

Killan
SSC-27-12-56
22.0 cm / 8 3/4"

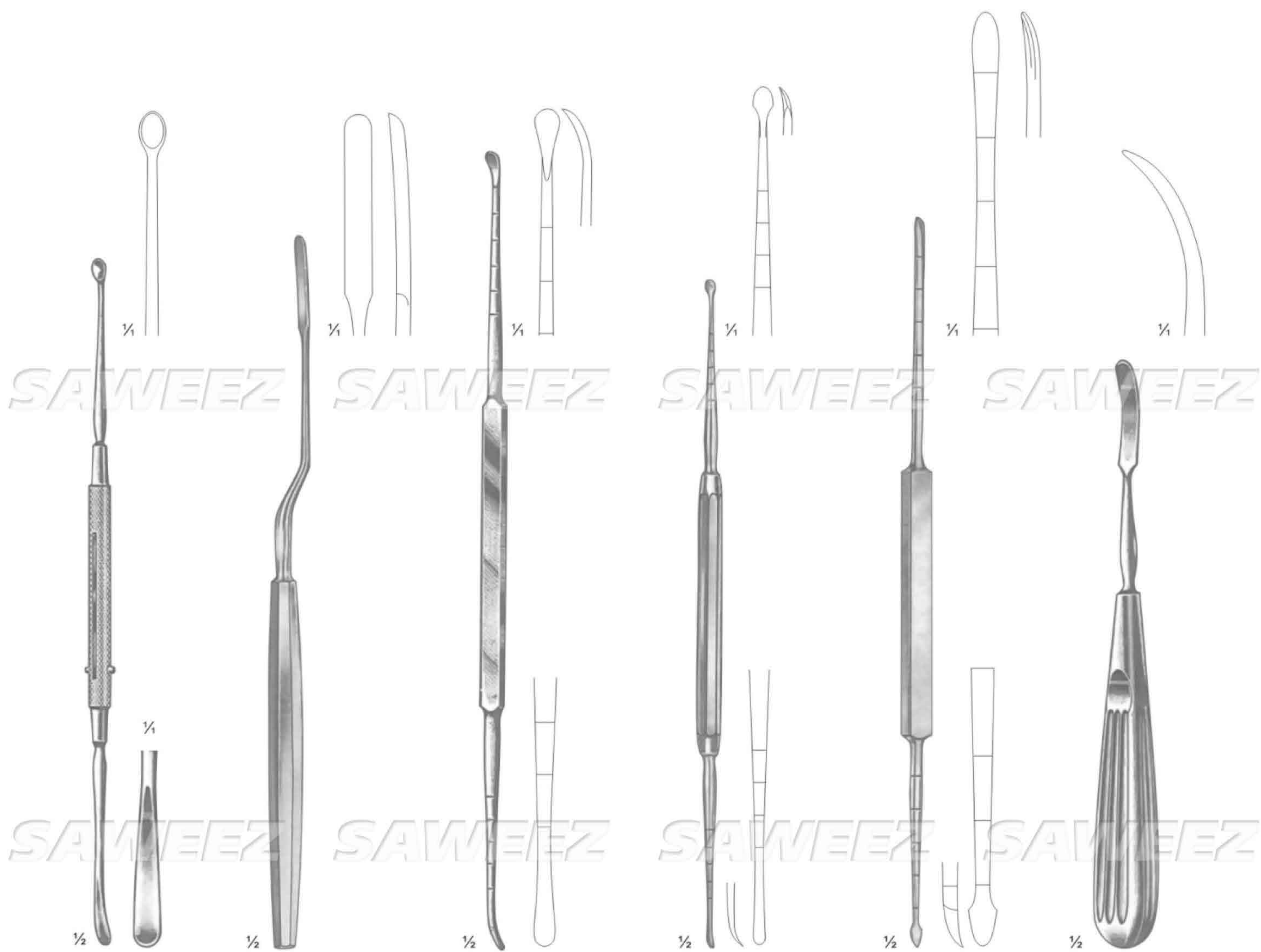
Pierce
SSC-27-12-57
21.0 cm / 8 1/4"

Pennington
SSC-27-12-58
21.0 cm / 8 1/4"

Roger
SSC-27-12-59
19.0 cm / 7 1/2"



SAWEEZ SAWEEZ SAWEEZ SAWEEZ



Carter
SSC-27-12-60
21.0 cm / 8¼"

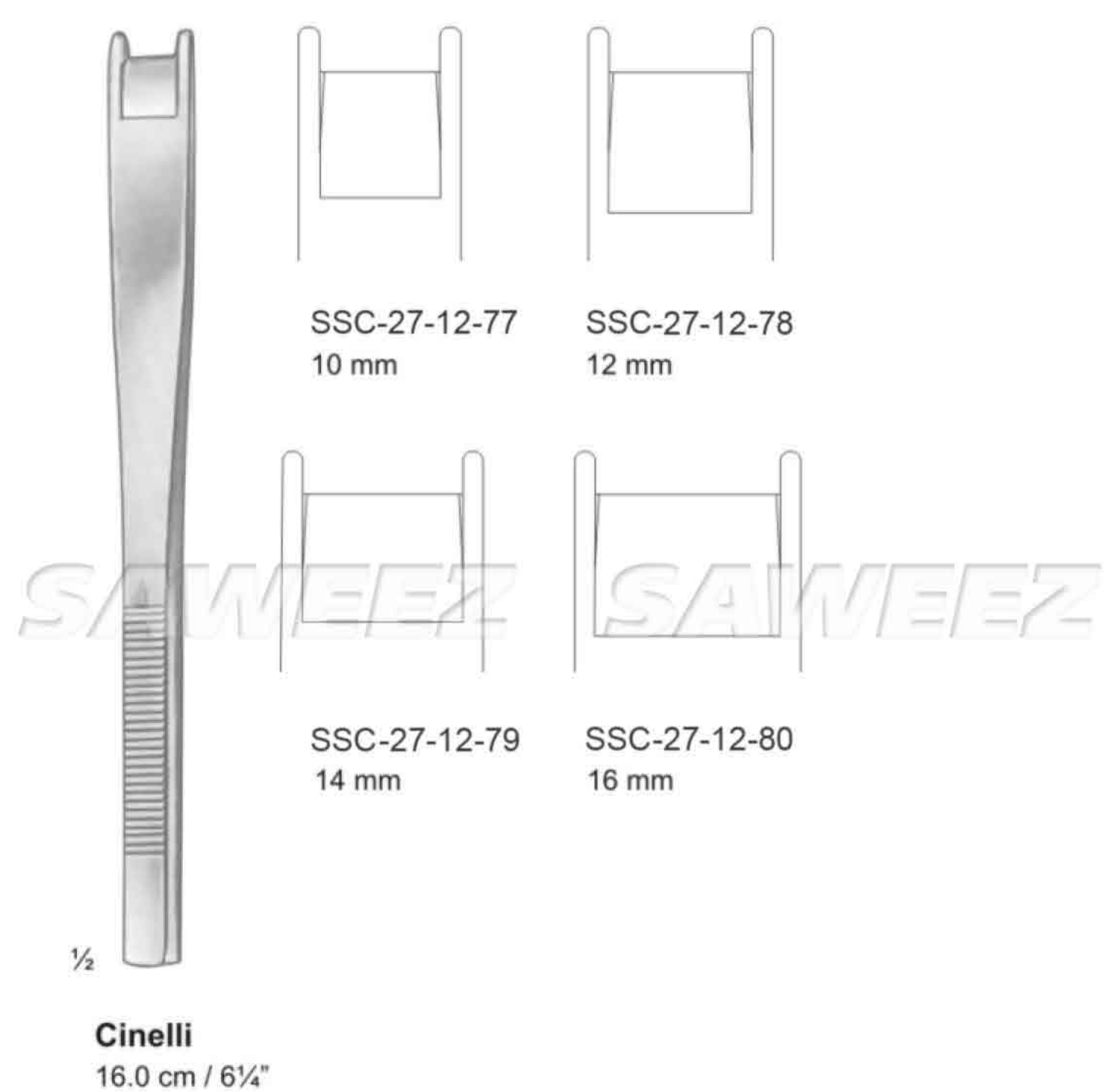
Joseph-Masing
SSC-27-12-61
22.0 cm / 8¾"

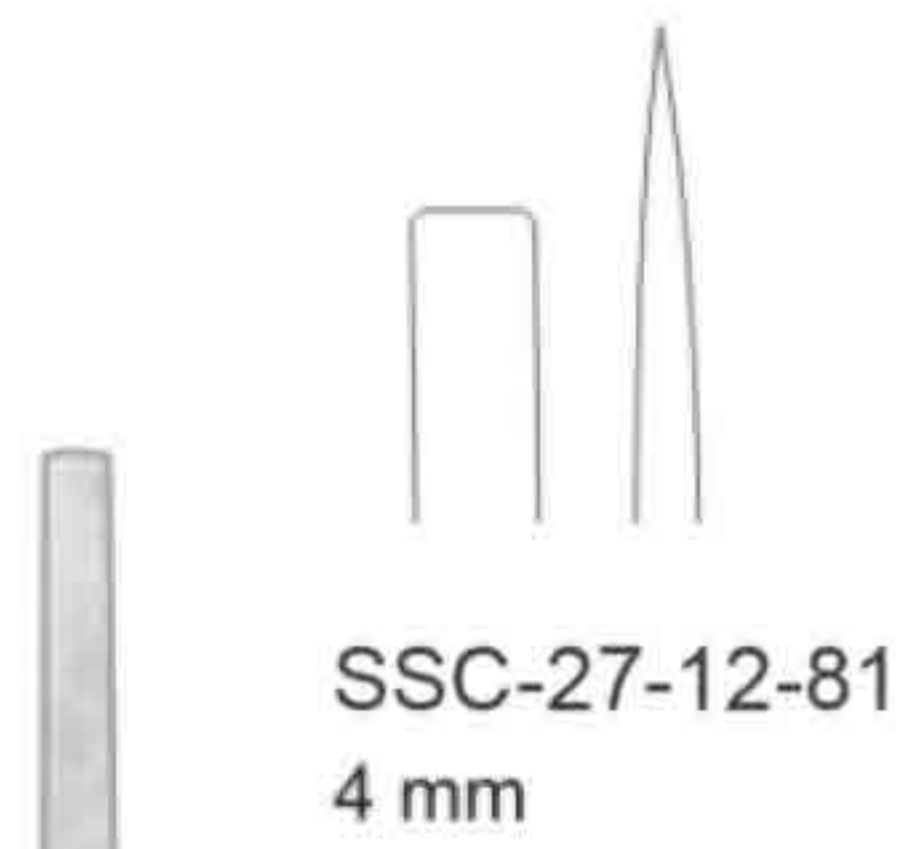
Cottle
SSC-27-12-62
22.0 cm / 8¾"

Masing
SSC-27-12-63
21.0 cm / 8¼"

Cottle
SSC-27-12-64
21.0 cm / 8¼"

Joseph
SSC-27-12-65
16.0 cm / 6¼"





SSC-27-12-81
4 mm



SSC-27-12-82
7 mm



SSC-27-12-83
9 mm



SSC-27-12-84
12 mm

Cottle
18.0 cm / 7"



SSC-27-12-86

Cottle
18.0 cm / 7"



SSC-27-12-88
4 mm

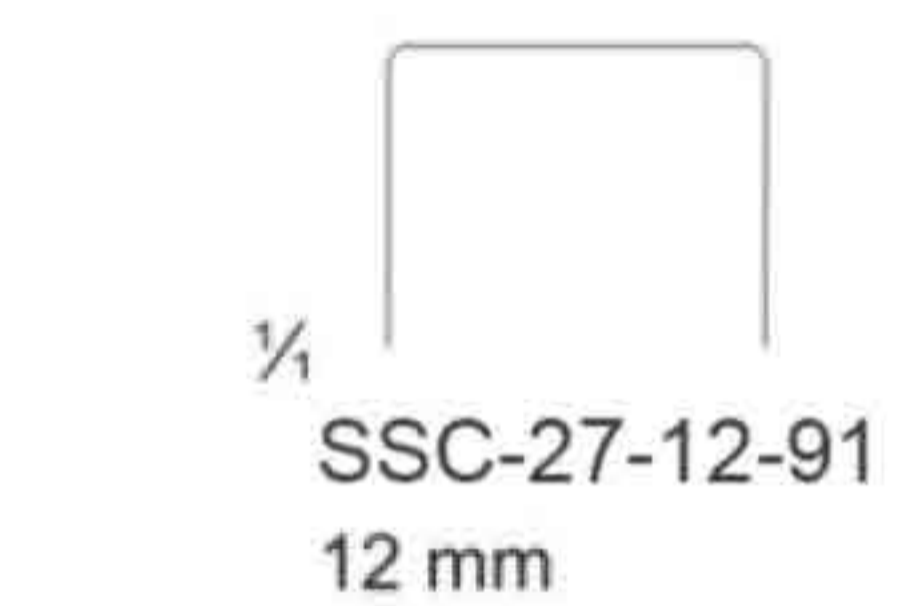
Cottle
18.0 cm / 7"



SSC-27-12-89
7 mm



SSC-27-12-90
9 mm



SSC-27-12-91
12 mm



SSC-27-12-85
6 mm

Cottle
18.0 cm / 7"



SSC-27-12-87
16 mm

Cottle
18.0 cm / 7"



SSC-27-12-92
16 mm

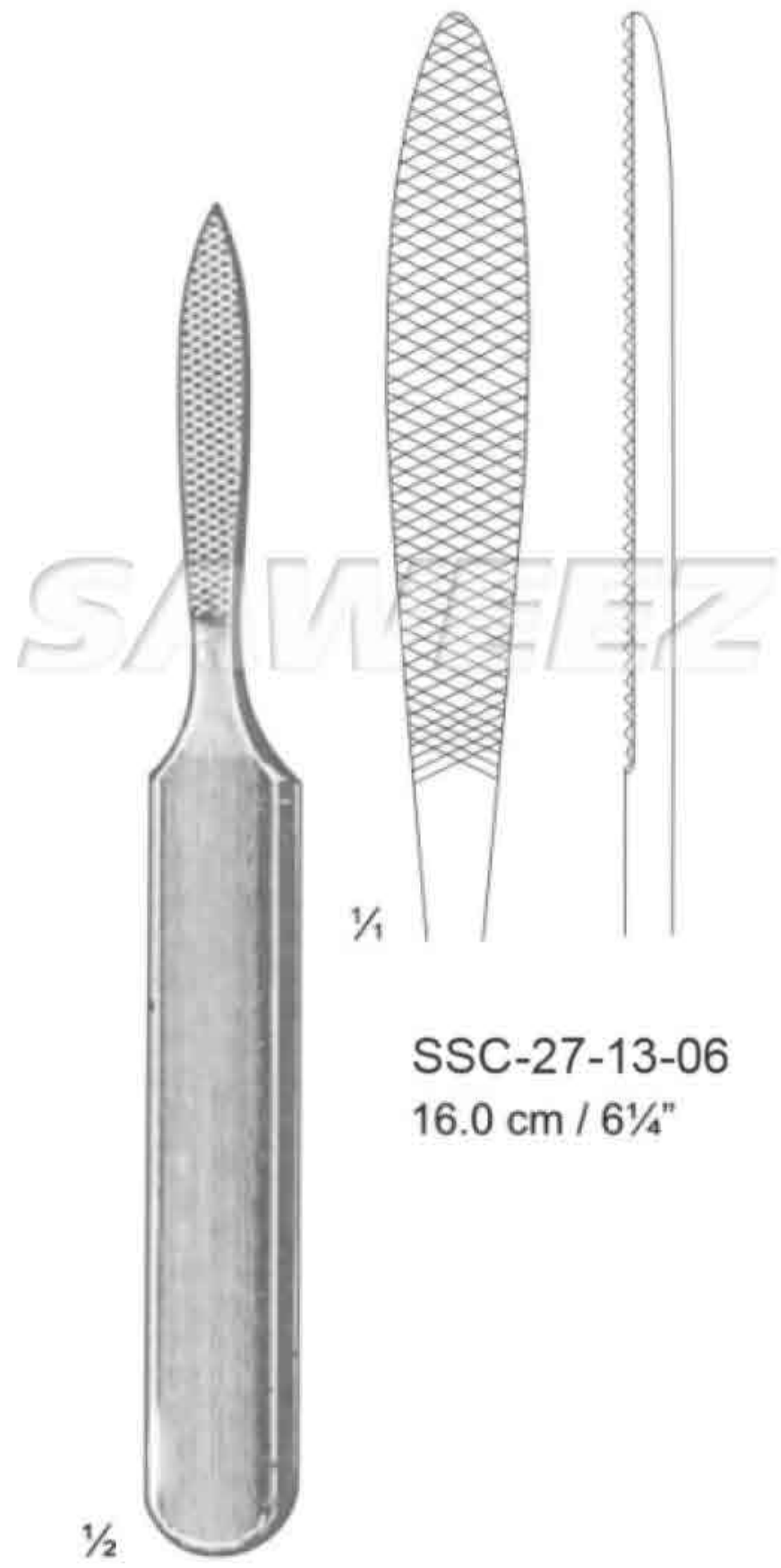
Cottle
18.0 cm / 7"



SSC-27-13-05
18.0 cm / 7"

1/2

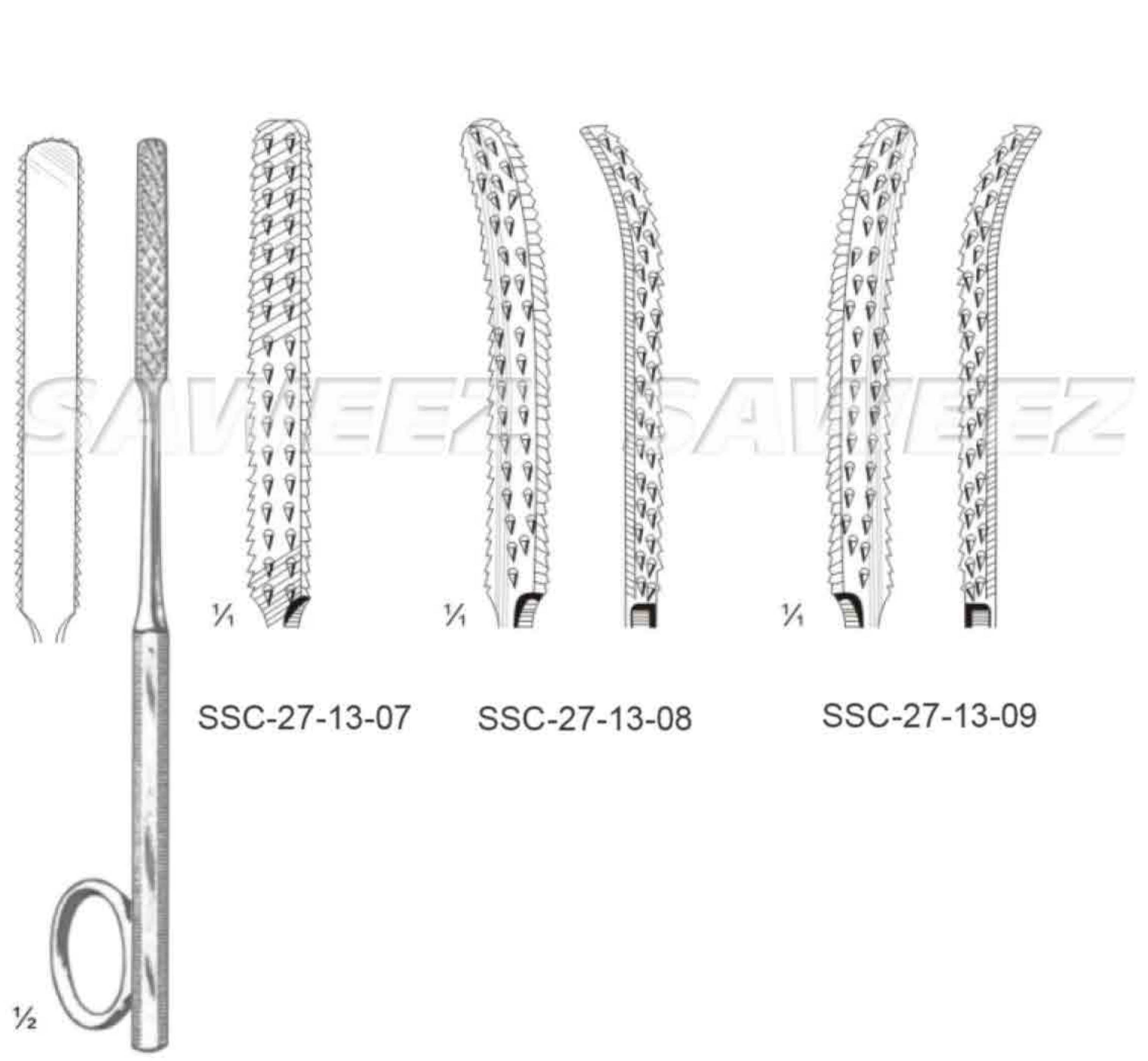
Maltz



SSC-27-13-06
16.0 cm / 6 1/4"

1/2

Joseph



SSC-27-13-07

1/2

Gallaher
16.0 cm / 6 1/4"

SSC-27-13-08

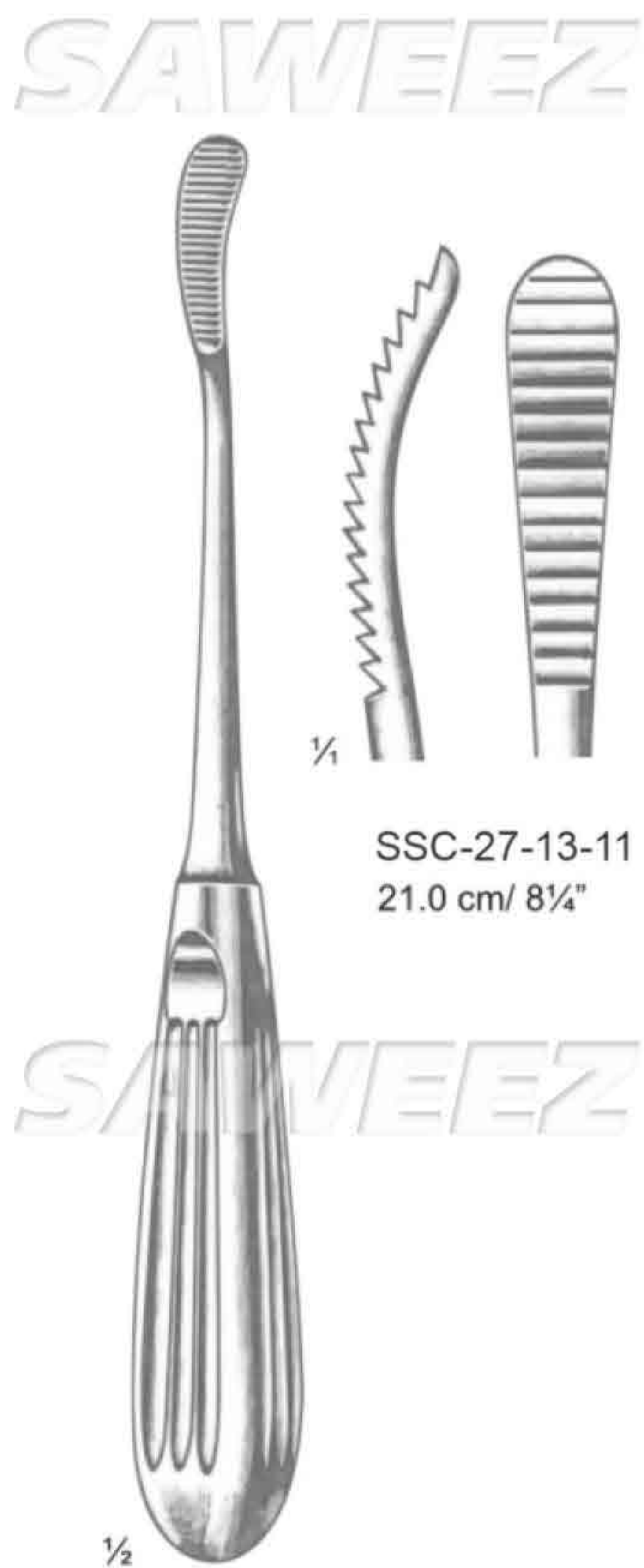
SSC-27-13-09



SSC-27-13-10
21.0 cm / 8 1/4"

1/2

Cottle



SSC-27-13-11
21.0 cm / 8 1/4"

1/2

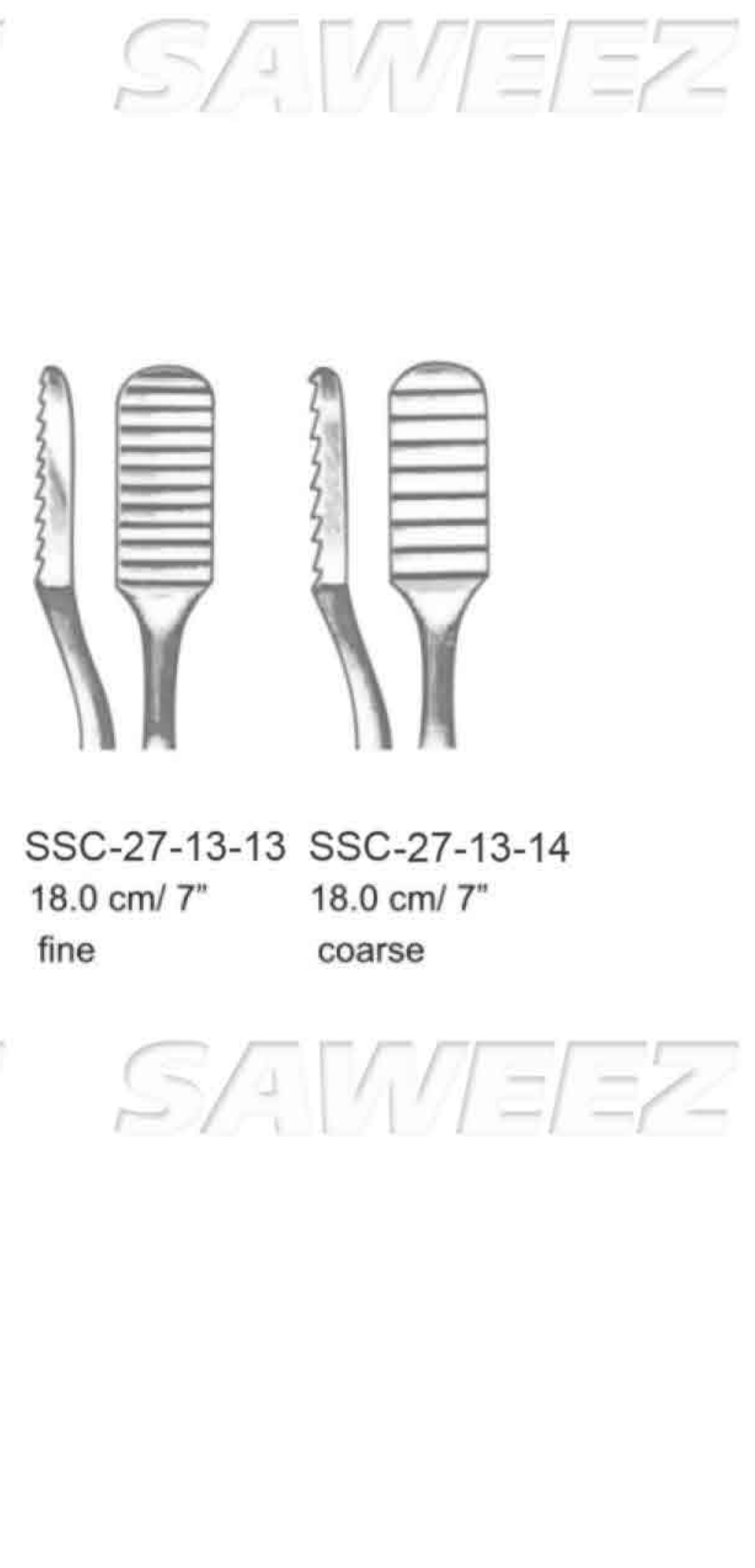
Aufricht



SSC-27-13-12
21.0 cm / 8 1/4"

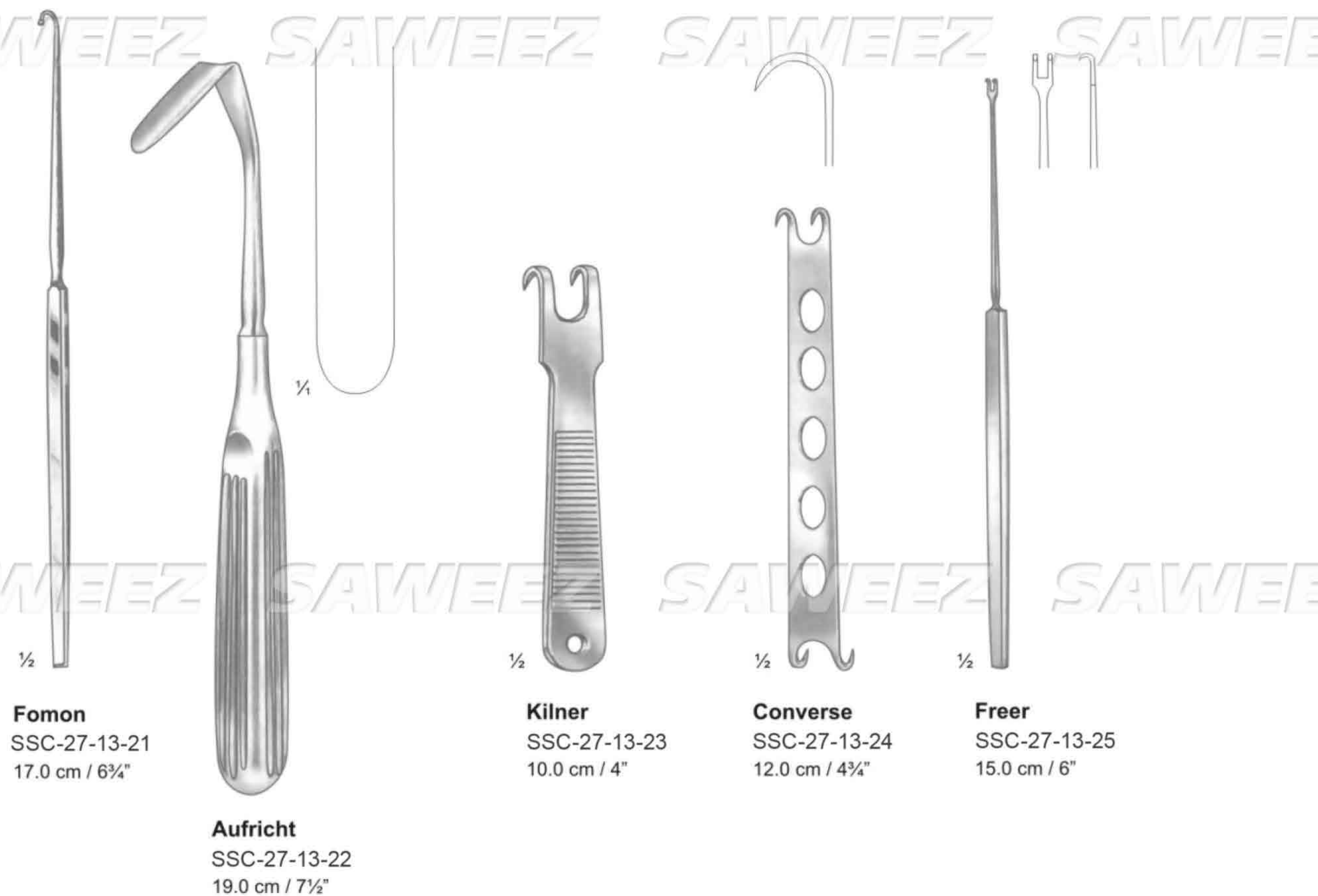
1/2

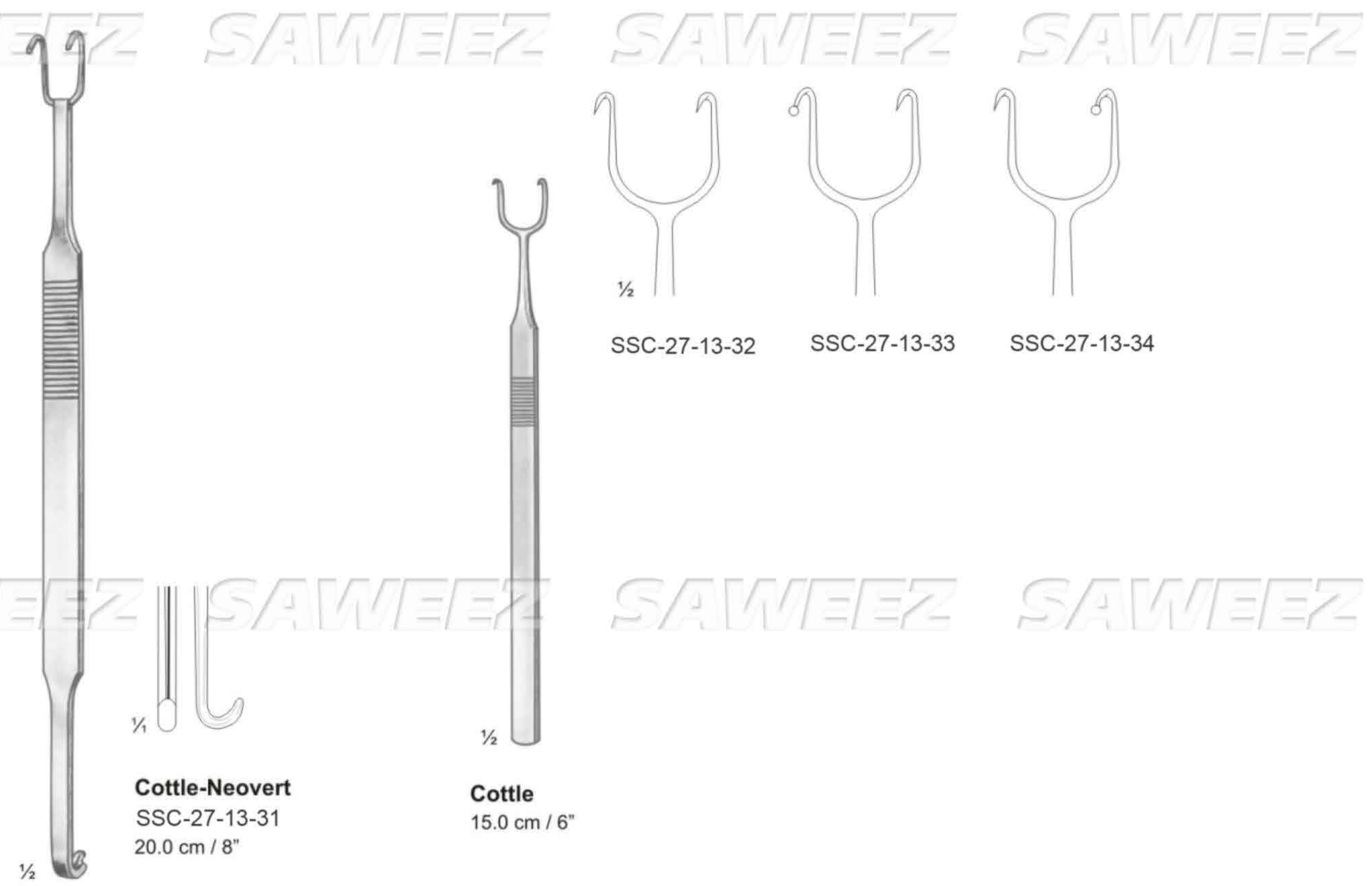
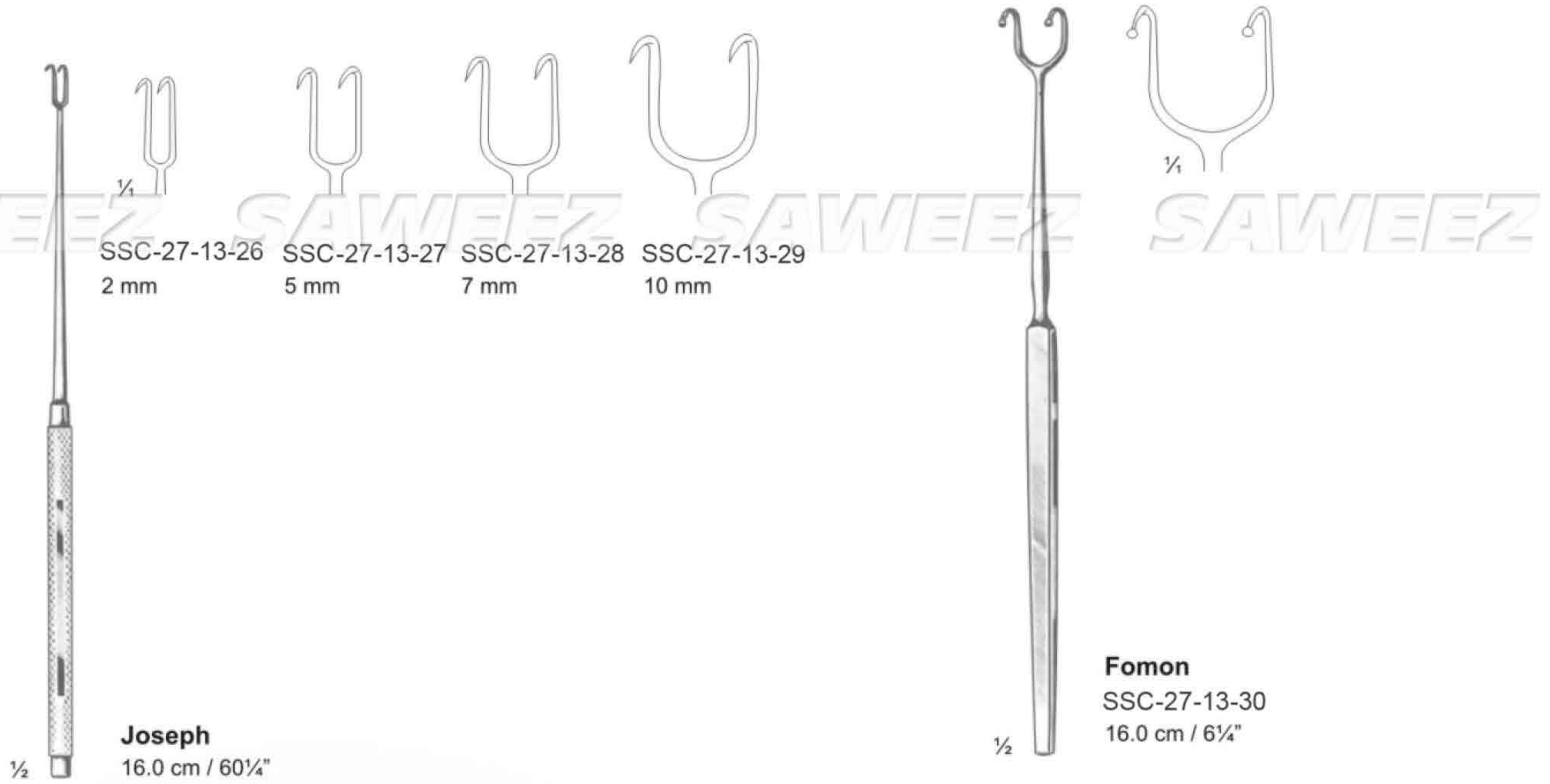
Lewis



SSC-27-13-13
18.0 cm / 7"
fine

SSC-27-13-14
18.0 cm / 7"
coarse







Cottle SSC-27-13-35 14.0 cm / 5½"	Neivert SSC-27-13-36 16.0 cm / 6¼"	Cottle SSC-27-13-37 15.0 cm / 6"	Cottle SSC-27-13-38 15.0 cm / 6"	Aufricht SSC-27-13-39 13.5 cm / 5¼"
--	---	---	---	--



SSC-27-13-40	SSC-27-13-41	SSC-27-13-42	SSC-27-13-43	SSC-27-13-44	SSC-27-13-45	SSC-27-13-46	SSC-27-13-47	SSC-27-13-48
--------------	--------------	--------------	--------------	--------------	--------------	--------------	--------------	--------------

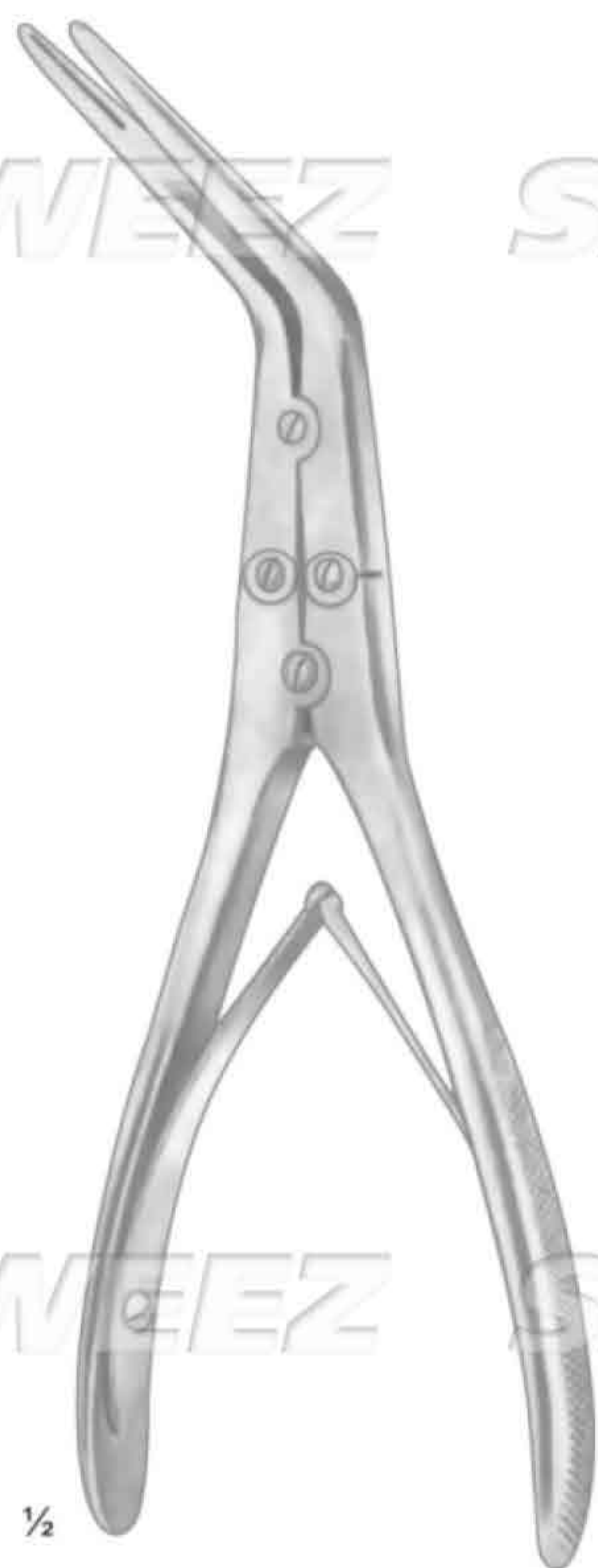
Yankauer (Septum Surure Needles)



SAWEEZ SAWEEZ SAWEEZ SAWEEZ



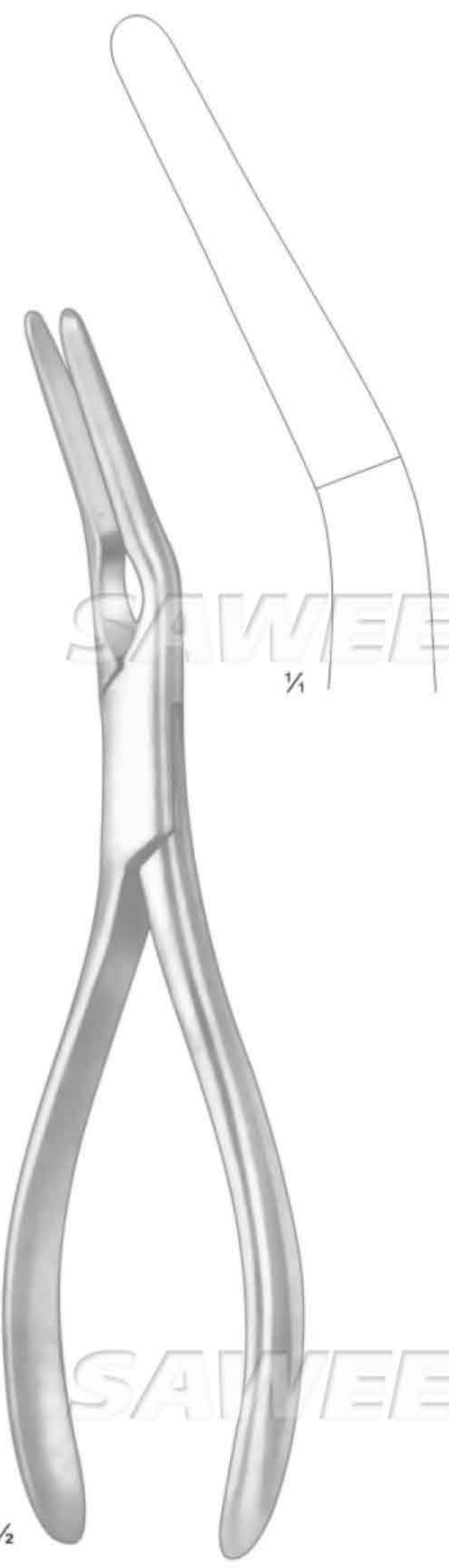
SAWEEZ SAWEEZ SAWEEZ SAWEEZ



Kressner
SSC-27-13-49
20.0 cm / 8"



Cottle-Walsham
23.0 cm / 9"



Asch
SSC-27-13-53
23.0 cm / 9"

SAWEEZ SAWEEZ SAWEEZ SAWEEZ



SAWEEZ SAWEEZ SAWEEZ SAWEEZ



Prapp
SSC-27-13-54
21.0 cm / 8 1/4"



Faulkner
SSC-27-13-55
21.0 cm / 8 1/4"



Coakley
17.0 cm / 6 3/4"



SSC-27-13-62

SAWEEZ SAWEEZ SAWEEZ SAWEEZ

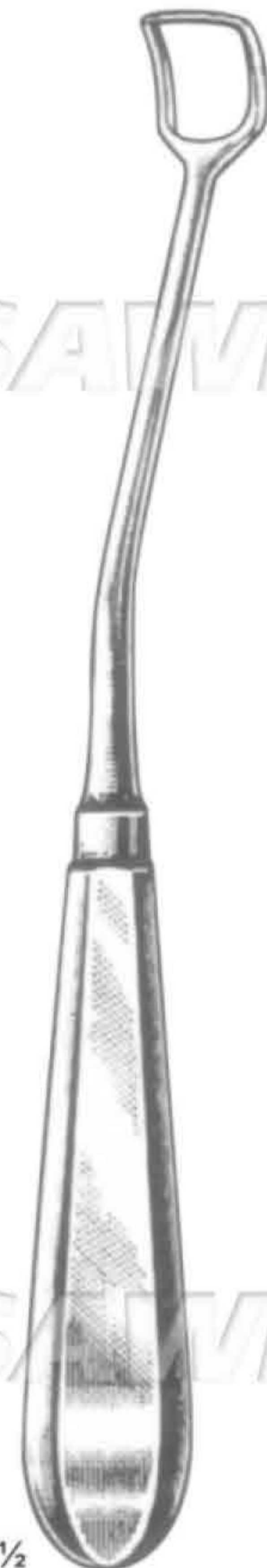
SAWEEZ SAWEEZ SAWEEZ SAWEEZ



1/2

Beckmann
22.0 cm / 8 3/4"

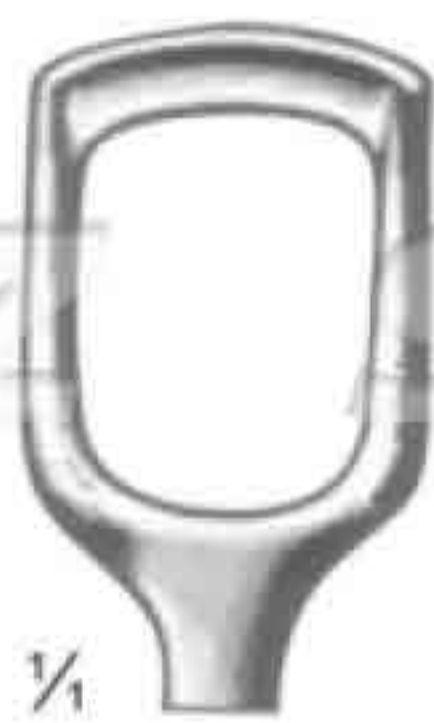
SSC-27-13-63 SSC-27-13-64



1/2

Beckmann
22.0 cm / 8 3/4"

SSC-27-13-65 SSC-27-13-66



1/4

SSC-27-13-67
SSC-27-13-68



SSC-27-13-69
SSC-27-13-70



SSC-27-13-71
SSC-27-13-72



SSC-27-13-73
SSC-27-13-74



SSC-27-13-75
SSC-27-13-76



SSC-27-13-77
SSC-27-13-78

SAWEEZ SAWEEZ SAWEEZ SAWEEZ



1/2

Beckmann
22.0 cm / 8 3/4"



1/4

SSC-27-13-79

SSC-27-13-80

SSC-27-13-81

SSC-27-13-82

SSC-27-13-83



1/2

St. Clair-Thomson
21.0 cm / 8 1/4"



1/4

SSC-27-13-84

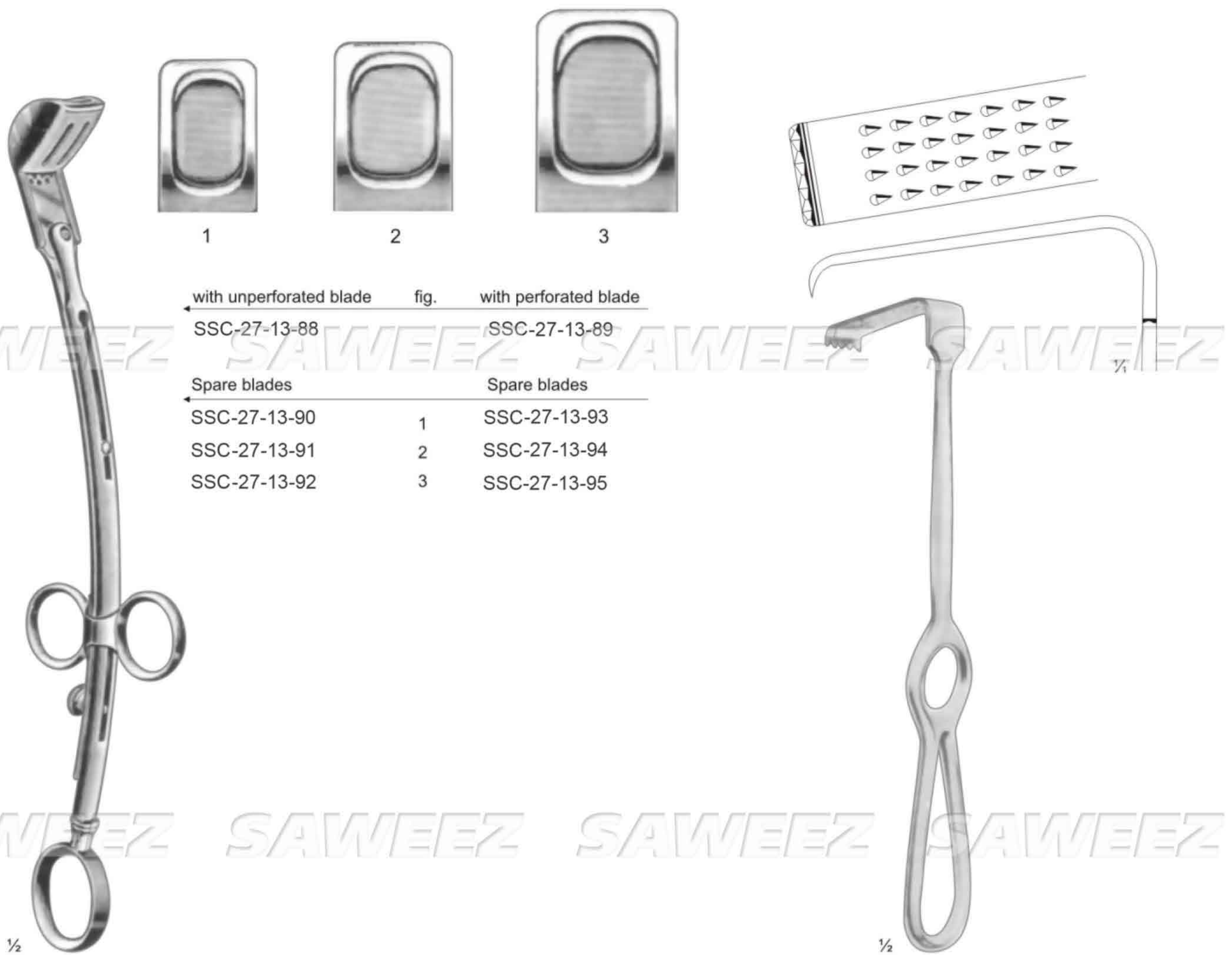
SSC-27-13-85

SSC-27-13-86

SSC-27-13-87



SAWEEZ SAWEEZ SAWEEZ SAWEEZ



La Force
(with one blade)
25.0 cm / 10"

Bruenings-Brunk
SML-27-13-96 (Antrum Retractors)
21.5 cm / 8½"

SAWEEZ SAWEEZ SAWEEZ SAWEEZ



1/2

SSC-29-11-11
23.0 cm / 9"



1/2

SSC-29-11-12
22.0 cm / 8 3/4"



1/2

SSC-29-11-13
17.0 cm / 6 3/4"



1/2

Gluck
SSC-29-11-14
22.0 cm / 8 3/4"

with eccentric sliding blade

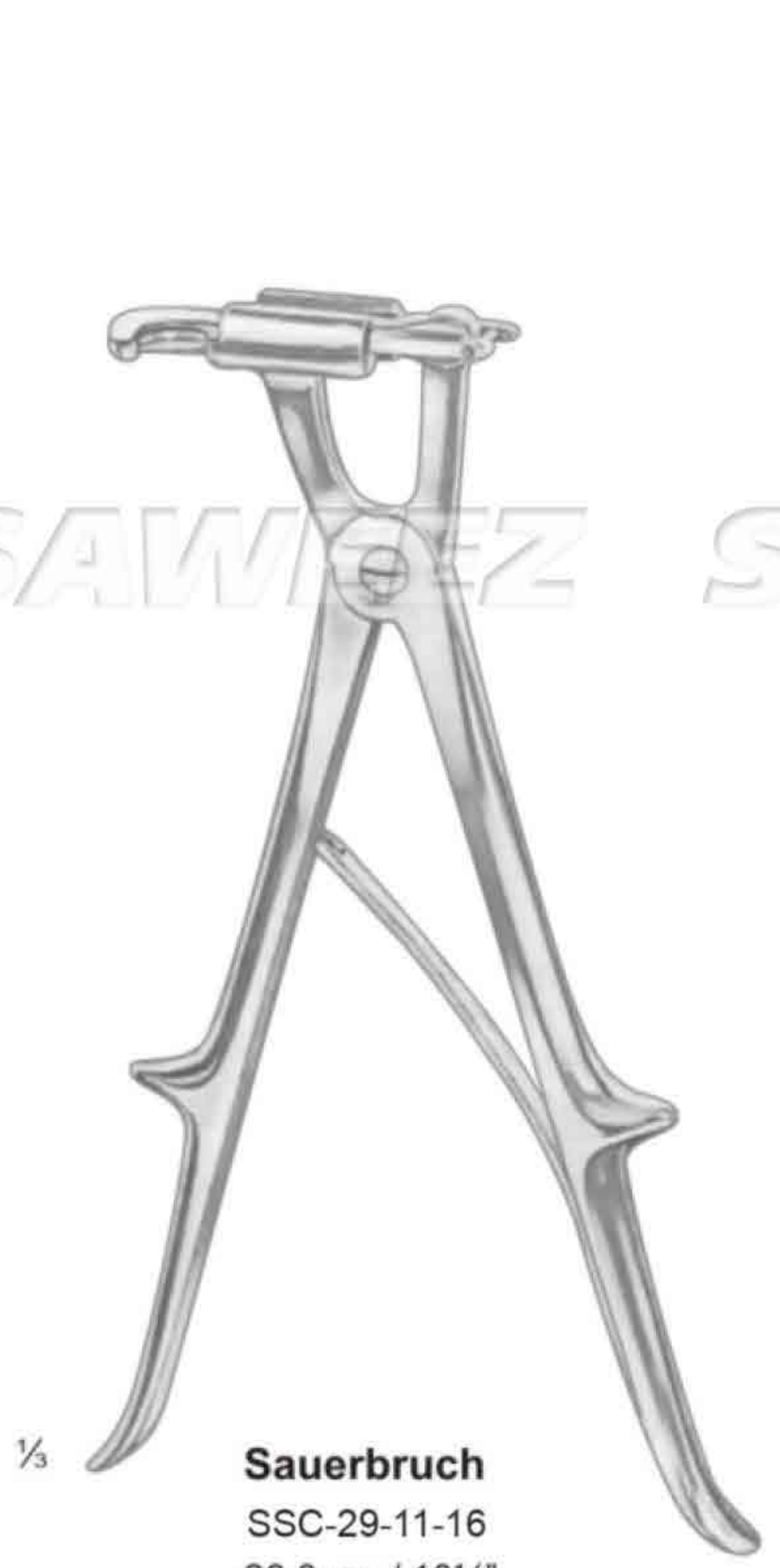


1/2

Stille
SSC-29-11-15
21.0 cm / 8 1/4"



SAWEEZ SAWEEZ SAWEEZ SAWEEZ



1/3 **Sauerbruch**
SSC-29-11-16
26.0 cm / 10 1/4"



1/3 **Giertz-Stille**
SSC-29-11-17
27.0 cm / 10 1/2"



1/3 **Sauerbruch-Frey**
SSC-29-11-18
36.0 cm / 14"

SAWEEZ SAWEEZ SAWEEZ SAWEEZ



1/3 **Lebsche**
SSC-29-11-21
25.0 cm / 10"



SSC-29-11-19
for the right hand

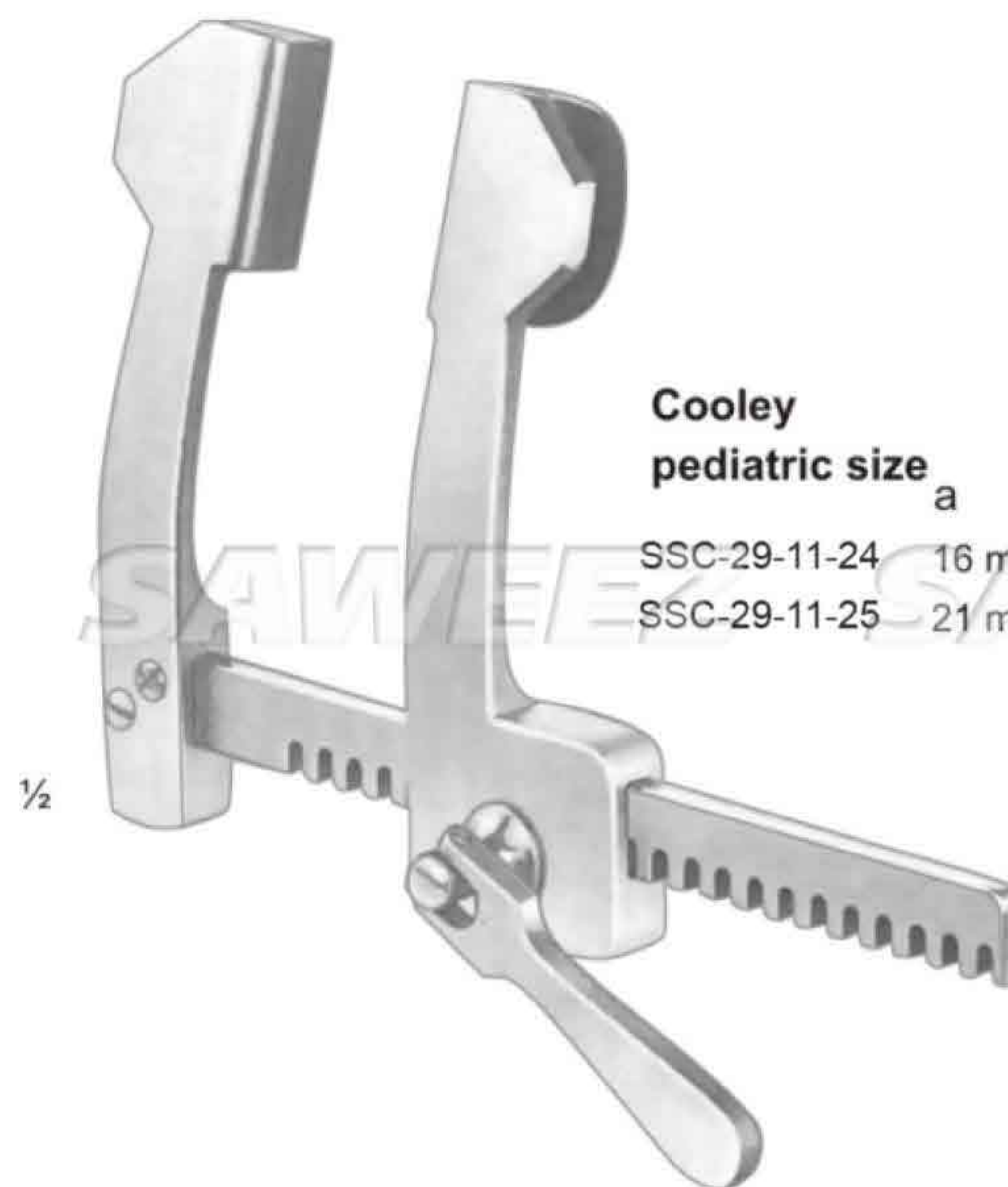
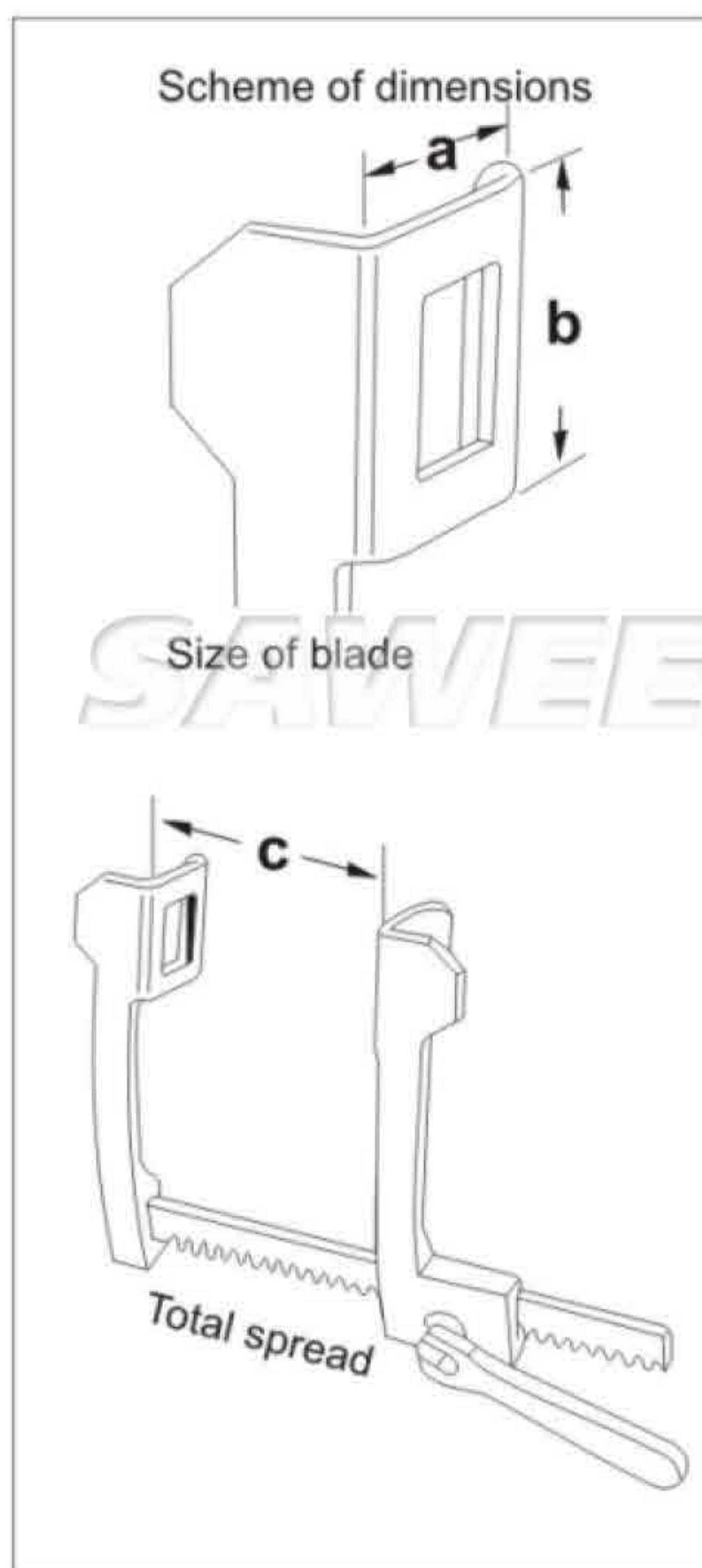
SSC-29-11-20
for the left hand

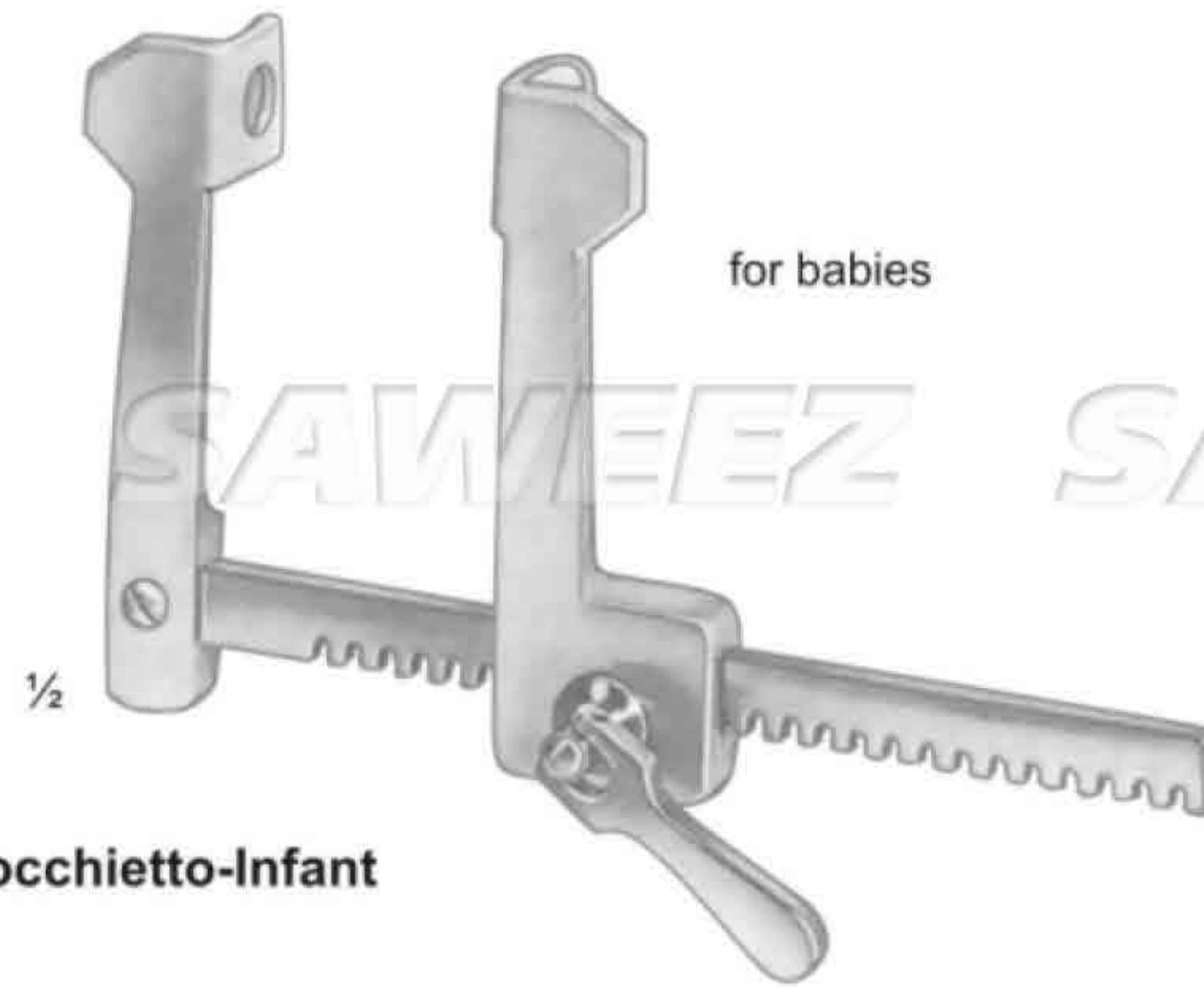
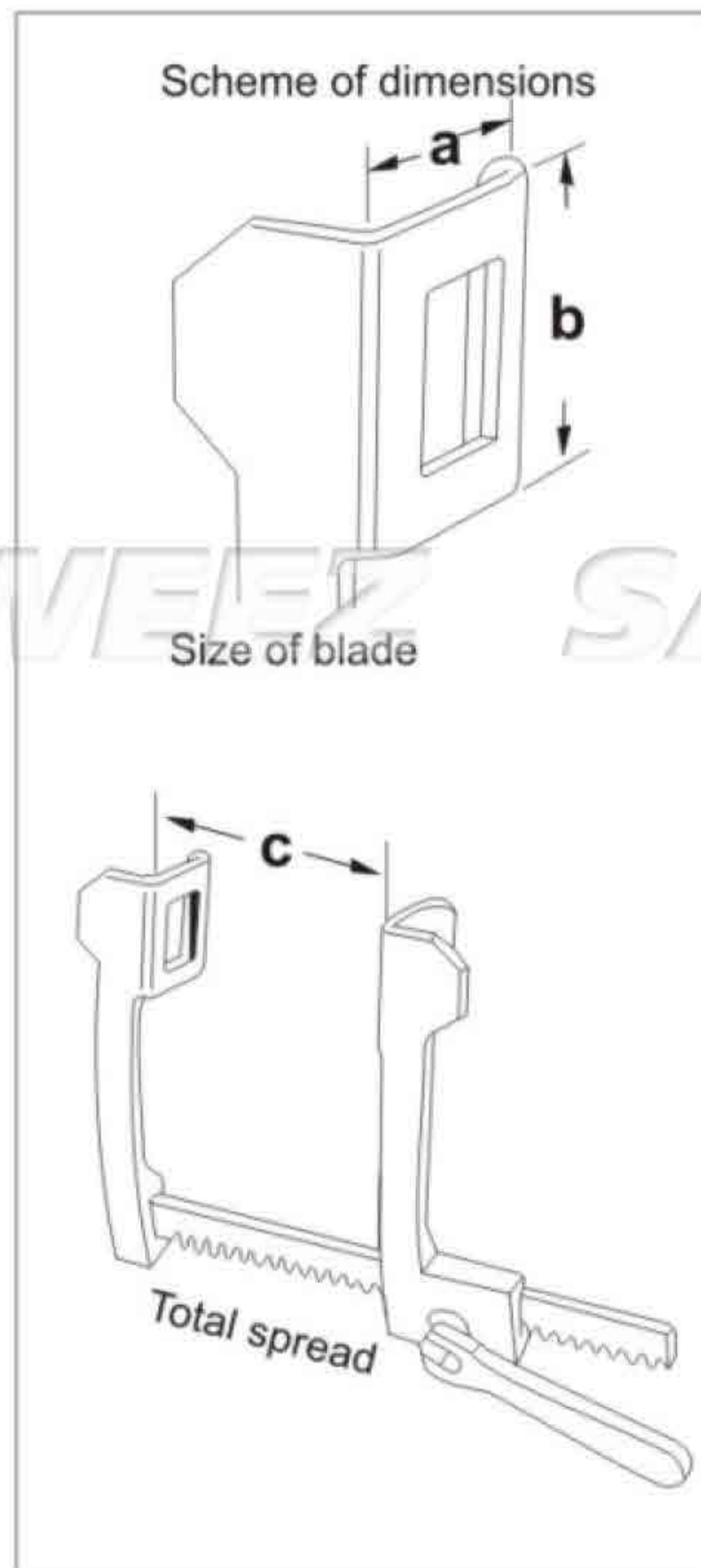
1/3 **Brunner**
32.0 cm / 12 1/2"



1/3 **Lebsche**
SSC-29-11-22
24.5 cm / 9 3/4"

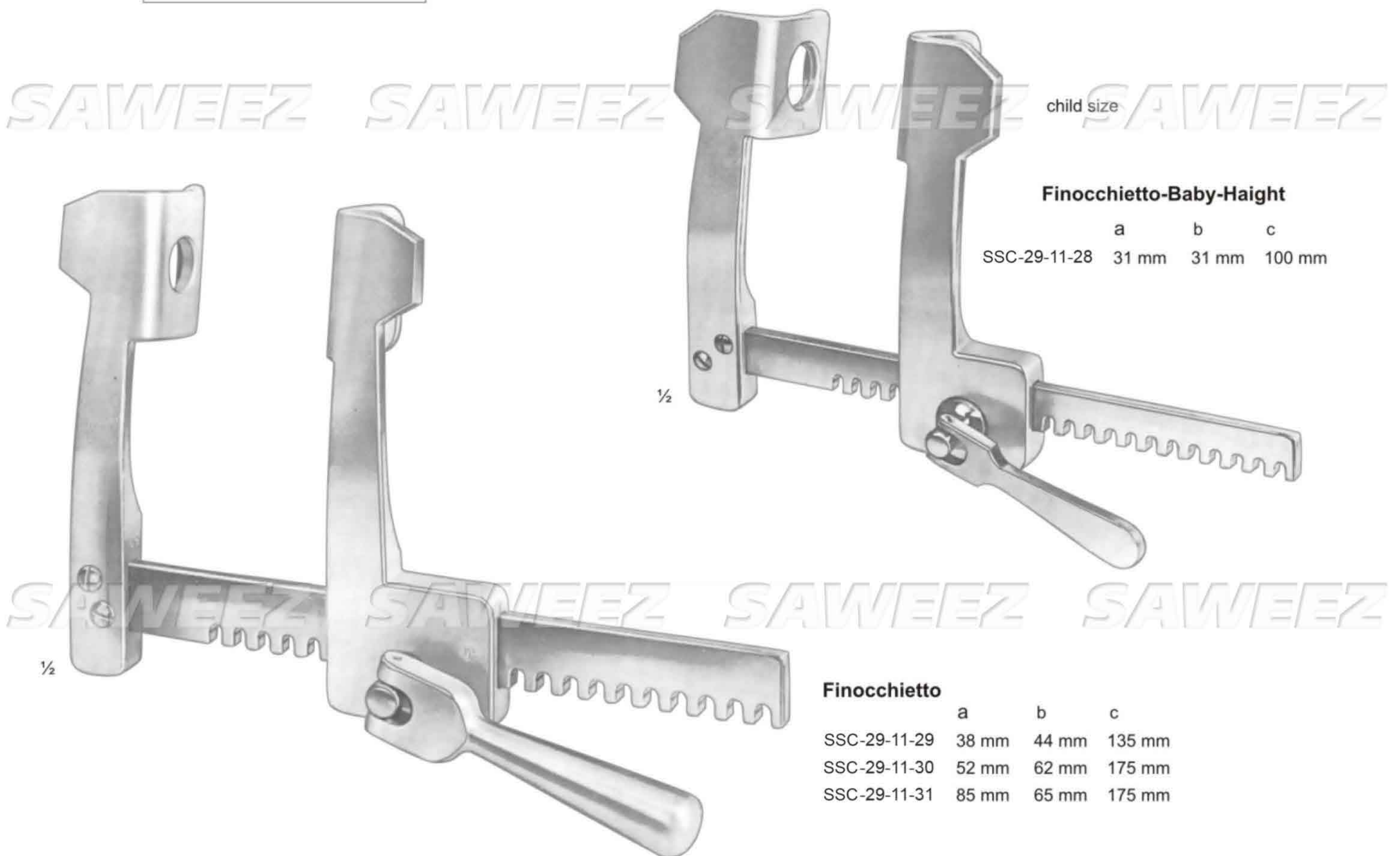
SAWEEZ SAWEEZ SAWEEZ SAWEEZ





Finocchietto-Infant

	a	b	c
SSC-29-11-27	15 mm	15 mm	75 mm



Finocchietto-Baby-Haight

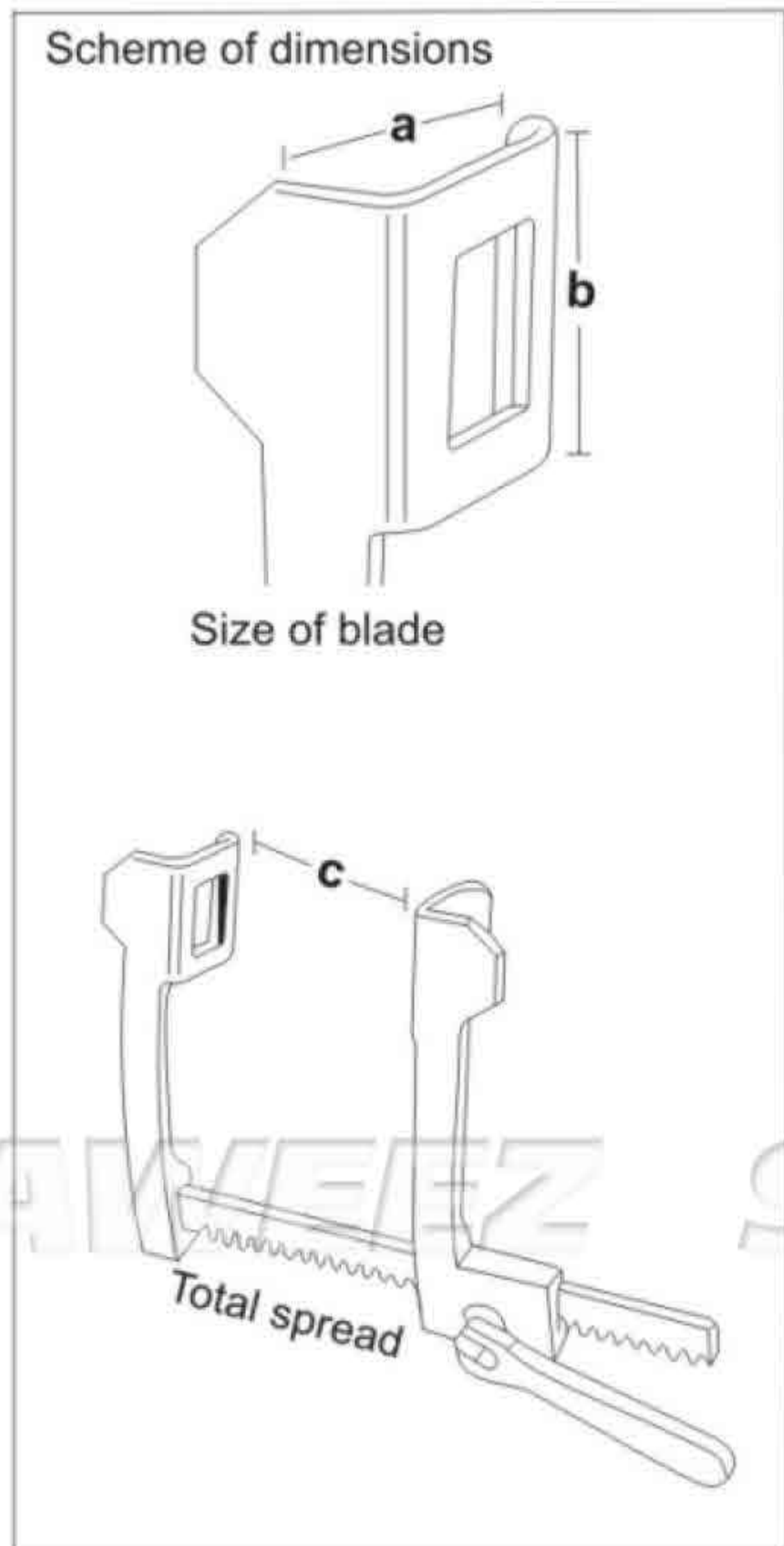
	a	b	c
SSC-29-11-28	31 mm	31 mm	100 mm

Finocchietto

	a	b	c
SSC-29-11-29	38 mm	44 mm	135 mm
SSC-29-11-30	52 mm	62 mm	175 mm
SSC-29-11-31	85 mm	65 mm	175 mm



SAWEEZ SAWEEZ SAWEEZ SAWEEZ

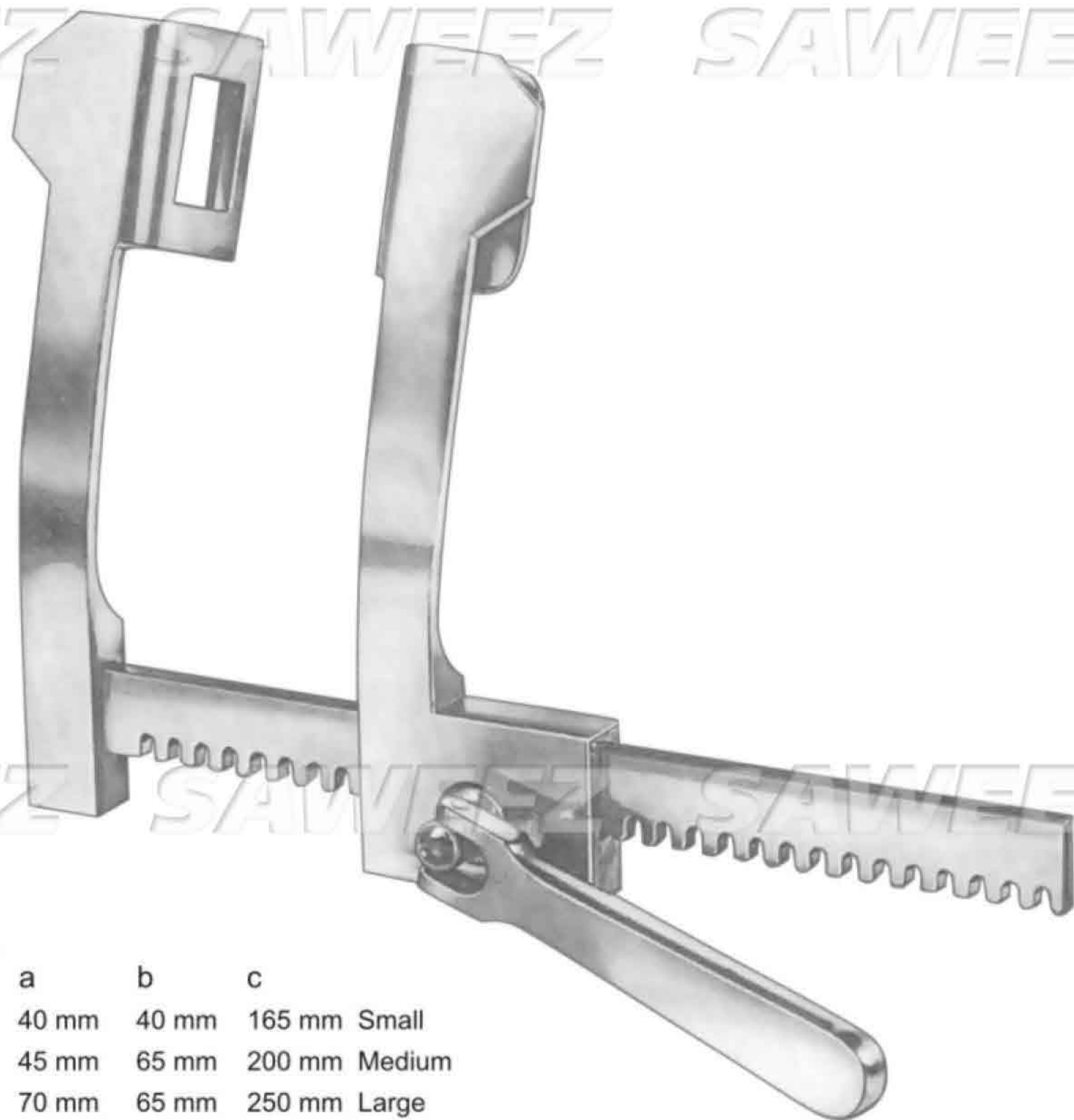


Finocchetto-Baby

	a	b	c
SSC-29-11-32	18 mm	20 mm	75 mm

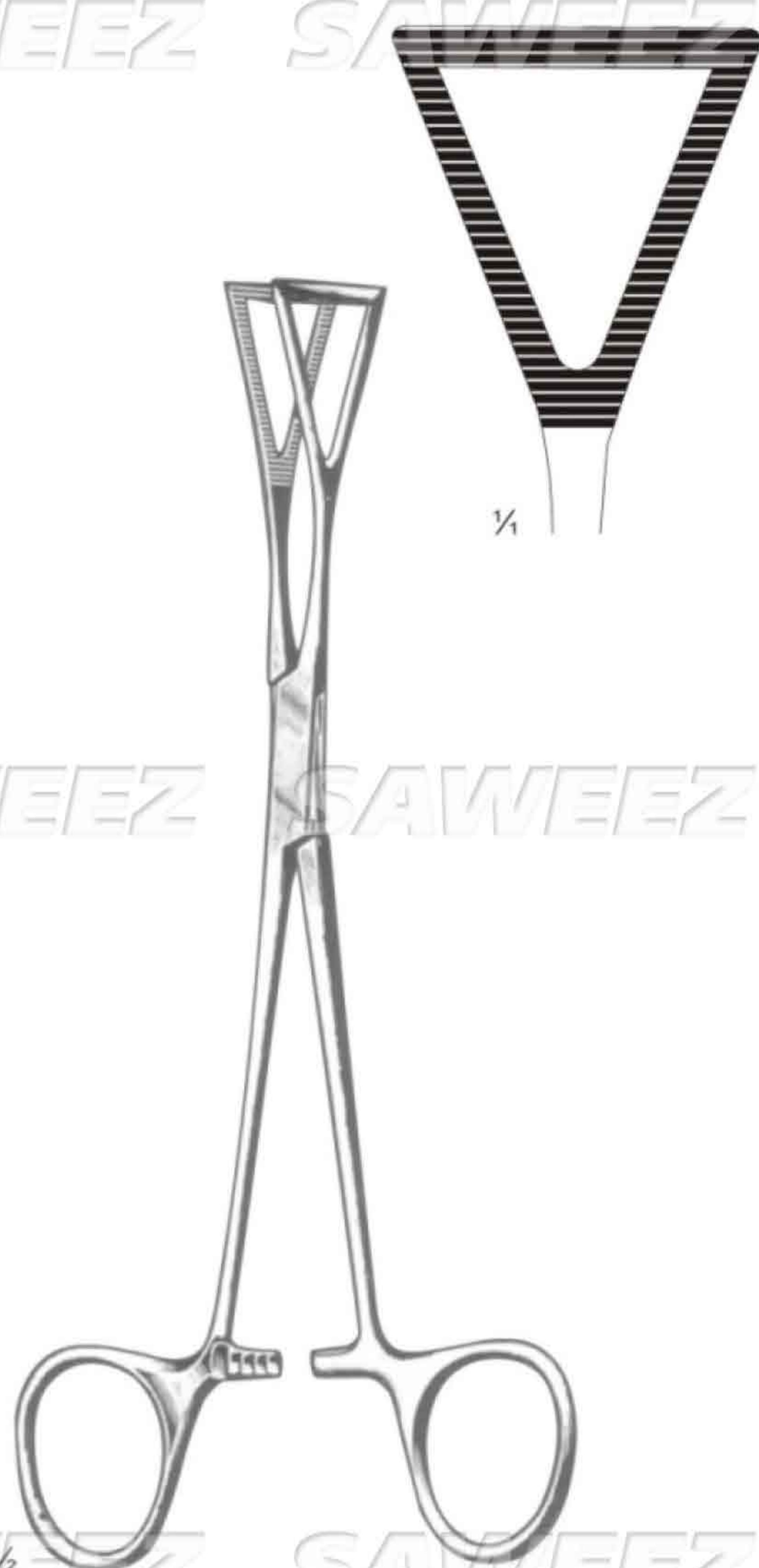


SAWEEZ SAWEEZ SAWEEZ SAWEEZ

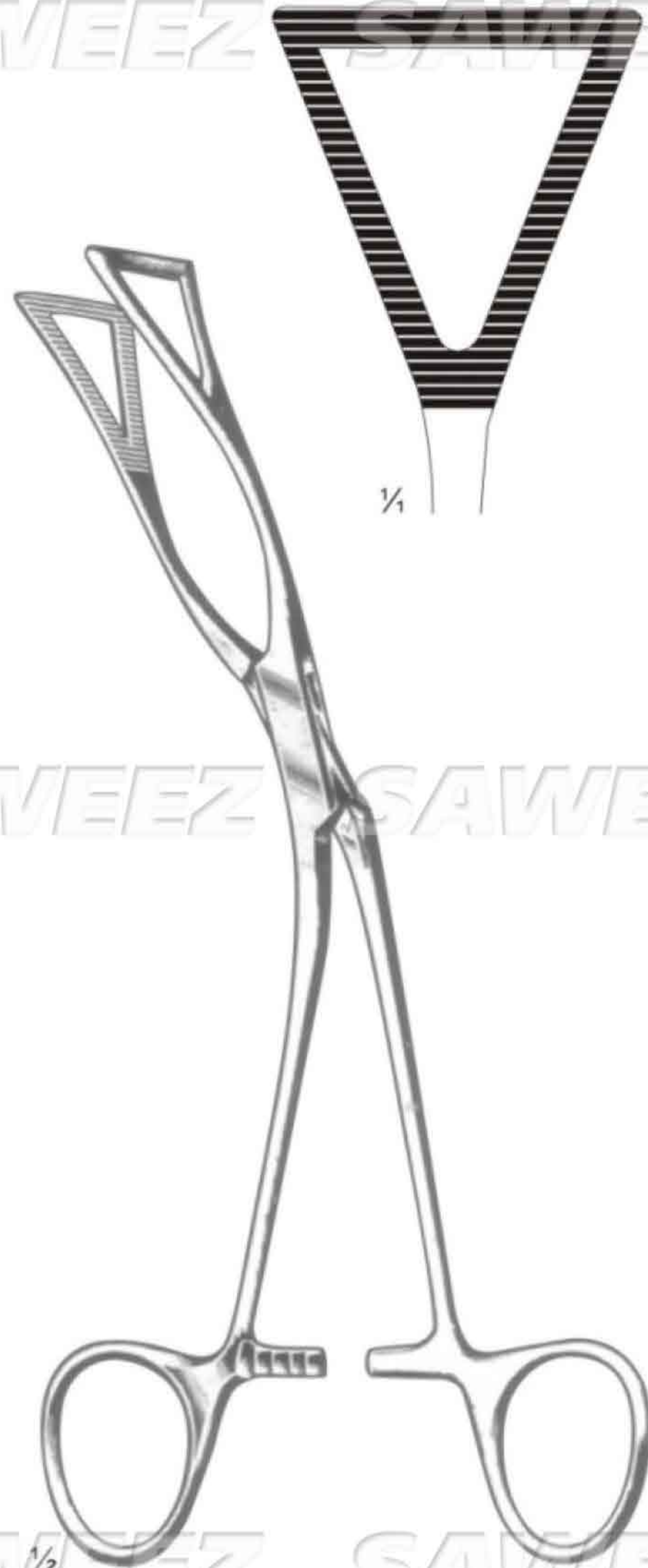


Finocchetto

	a	b	c	
SSC-29-11-33	40 mm	40 mm	165 mm	Small
SSC-29-11-34	45 mm	65 mm	200 mm	Medium
SSC-29-11-35	70 mm	65 mm	250 mm	Large



Lovelace
SSC-29-11-36
20.0 cm / 8"



Lovelace
SSC-29-11-37
20.0 cm / 8"



1/2

Dale

SSC-29-11-38
18.5 cm / 7 1/4"



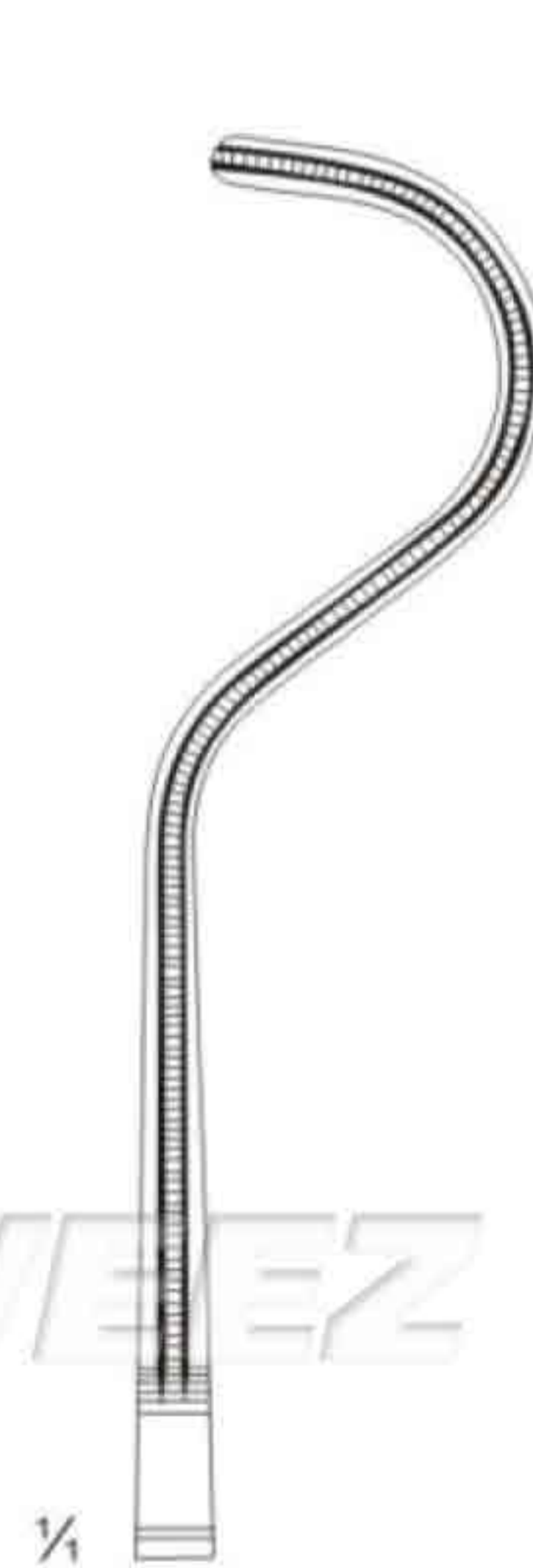
1/4

SAWEEZ SAWEEZ SAWEEZ SAWEEZ



1/2

Dale



1/4

SSC-29-11-39
17.0 cm / 6 3/4"



SSC-29-11-40
17.5 cm / 7"



SSC-29-11-41
18.5 cm / 7 1/4"

Peripheral vascular clamps

SAWEEZ SAWEEZ SAWEEZ SAWEEZ



2.7 mm

1/4

1.5 mm

1/4

2.0 mm

1/4

De Bakey
 SSC-29-11-42-16.0 cm / 6 1/4"
 SSC-29-11-43-20.0 cm / 8"
 SSC-29-11-44-24.0 cm / 9 1/2"
 SSC-29-11-45-30.0 cm / 12"

De Bakey
 SSC-29-11-46-16.0 cm / 6 1/4"
 SSC-29-11-47-20.0 cm / 8"
 SSC-29-11-48-24.0 cm / 9 1/2"

De Bakey
 SSC-29-11-49-16.0 cm / 6 1/4"
 SSC-29-11-50-20.0 cm / 8"
 SSC-29-11-51-24.0 cm / 9 1/2"
 SSC-29-11-52-30.0 cm / 12"

2.0 mm

1/4

3.5 mm

1/4

2.0 mm

1/4

De Bakey
 SSC-29-11-53-16.0 cm / 6 1/4"
 SSC-29-11-54-20.0 cm / 8"
 SSC-29-11-55-24.0 cm / 9 1/2"
 SSC-29-11-56-30.0 cm / 12"

De Bakey
 SSC-29-11-57-16.0 cm / 6 1/4"
 SSC-29-11-58-20.0 cm / 8"
 SSC-29-11-59-24.0 cm / 9 1/2"
 SSC-29-11-60-30.0 cm / 12"

Cooley
 SSC-29-11-61-16.0 cm / 6 1/4"
 SSC-29-11-62-20.0 cm / 8"

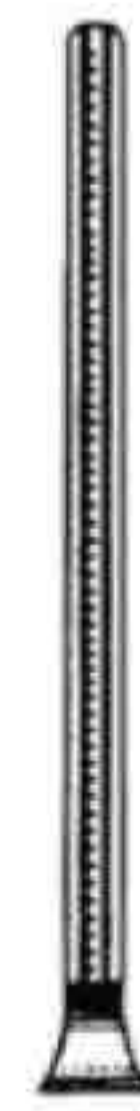


1/4

Bulldog



SSC-29-11-63
7.5 cm / 3"



SSC-29-11-64
8.5 cm / 3 1/2"



SSC-29-11-65
10.5 cm / 4 1/4"



SSC-29-11-66
12.0 cm / 4 3/4"



1/4

Bulldog



SSC-29-11-67
7.0 cm / 2 3/4"



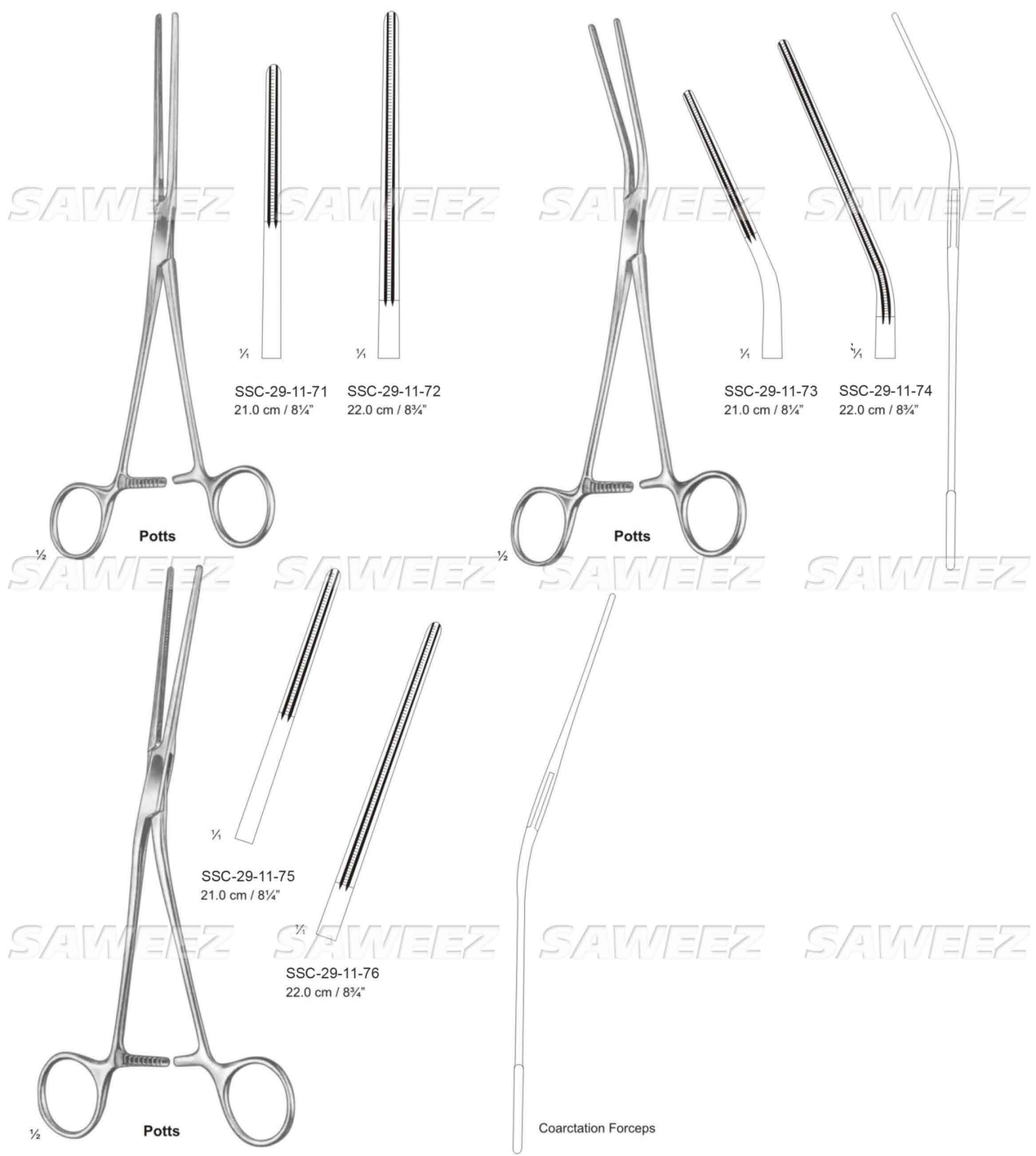
SSC-29-11-68
8.0 cm / 3 1/4"



SSC-29-11-69
10.0 cm / 4"



SSC-29-11-70
11.5 cm / 4 3/4"



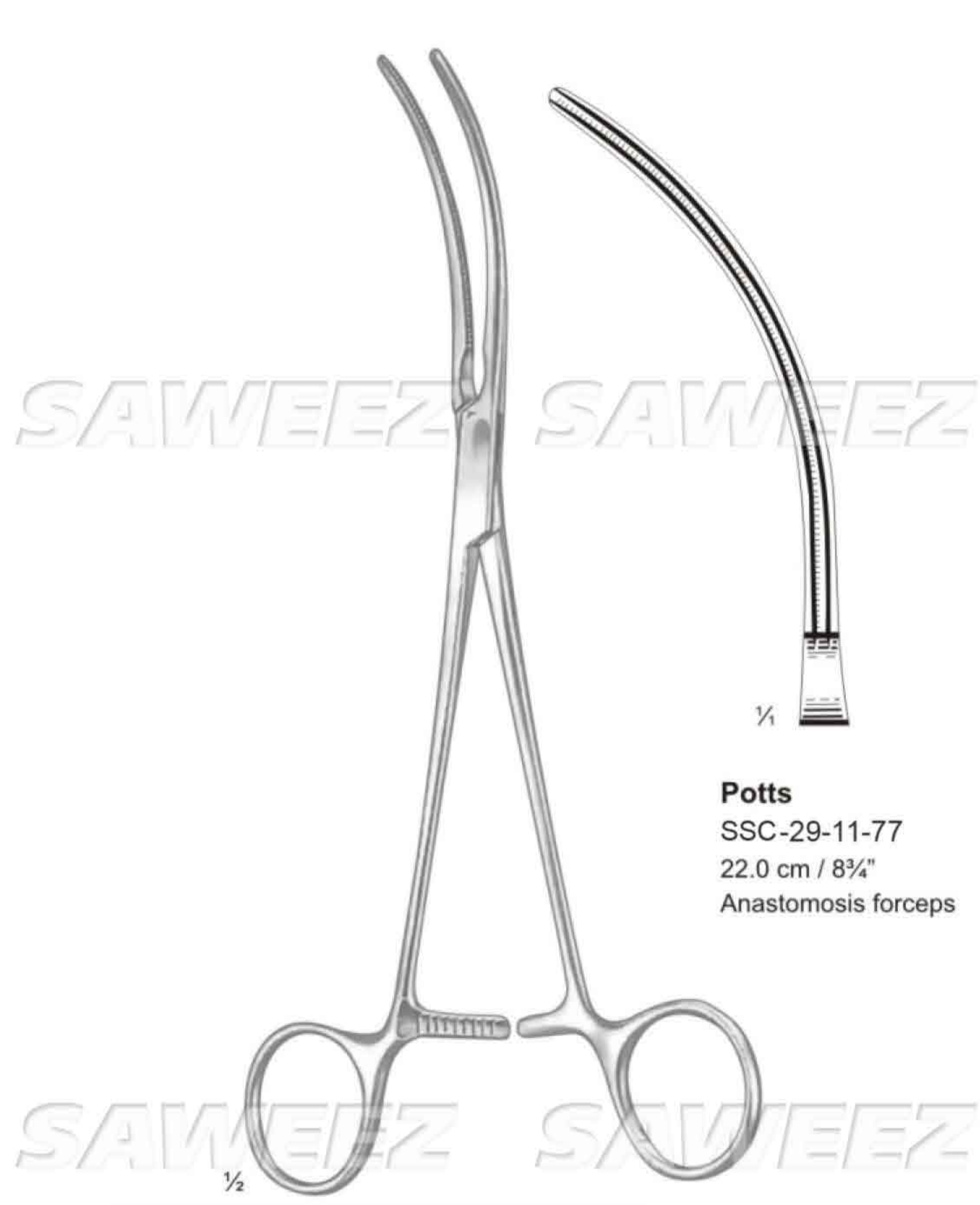
SSC-29-11-71 21.0 cm / 8 1/4"
SSC-29-11-72 22.0 cm / 8 3/4"

SSC-29-11-73 21.0 cm / 8 1/4"
SSC-29-11-74 22.0 cm / 8 3/4"

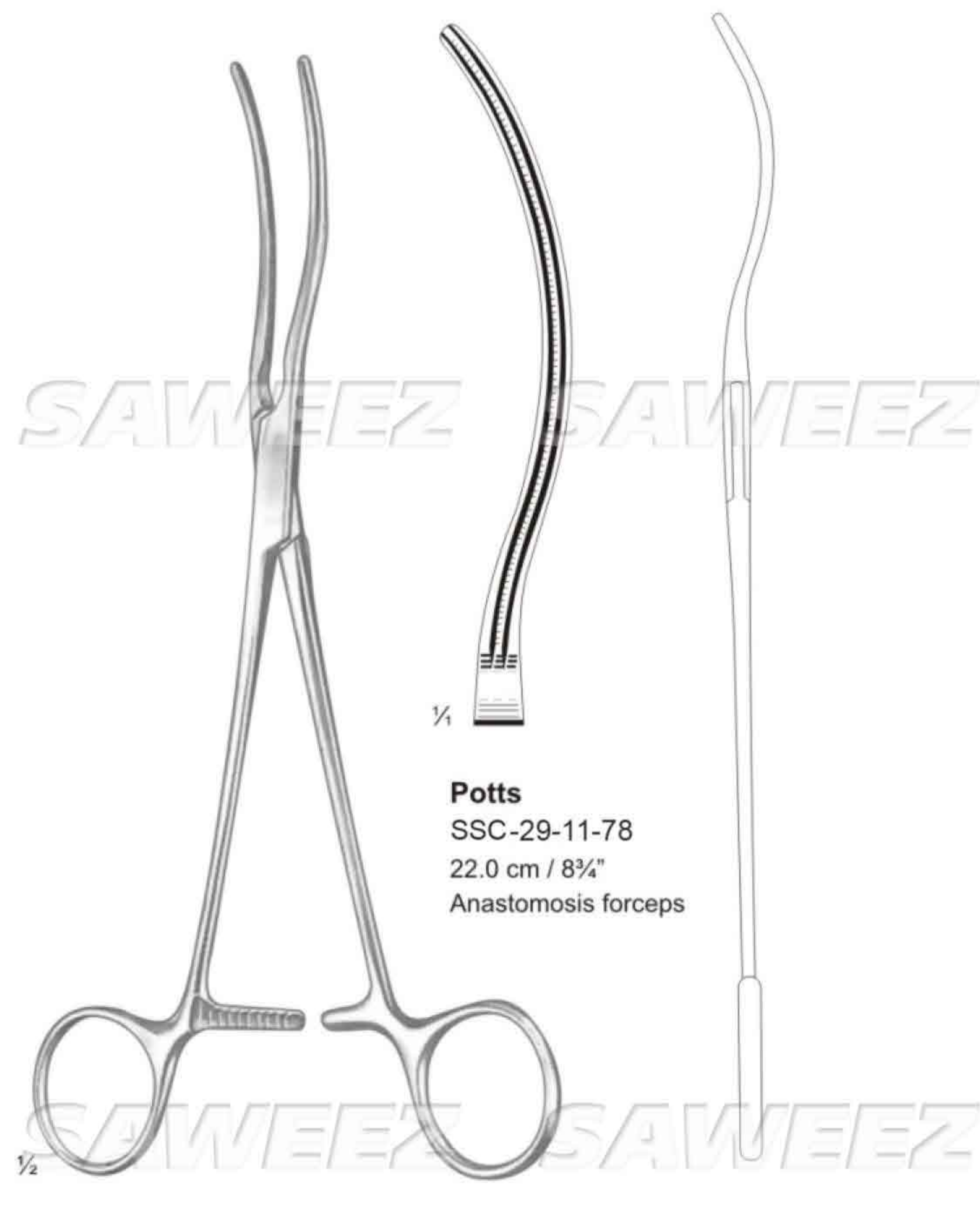
SSC-29-11-75 21.0 cm / 8 1/4"

SSC-29-11-76 22.0 cm / 8 3/4"

Coarctation Forceps



Potts
SSC-29-11-77
22.0 cm / 8 3/4"
Anastomosis forceps



Potts
SSC-29-11-78
22.0 cm / 8 3/4"
Anastomosis forceps



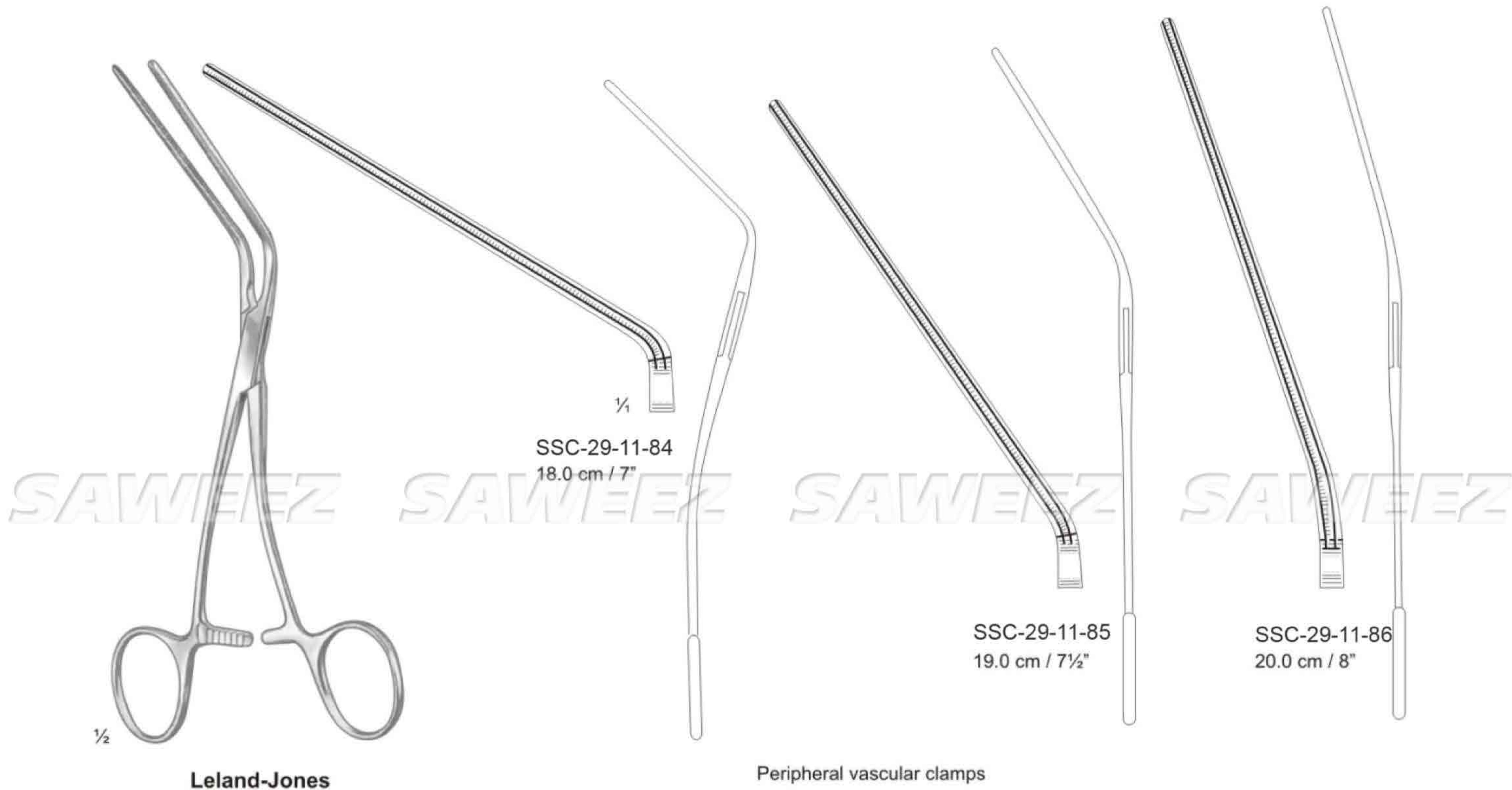
De Bakey

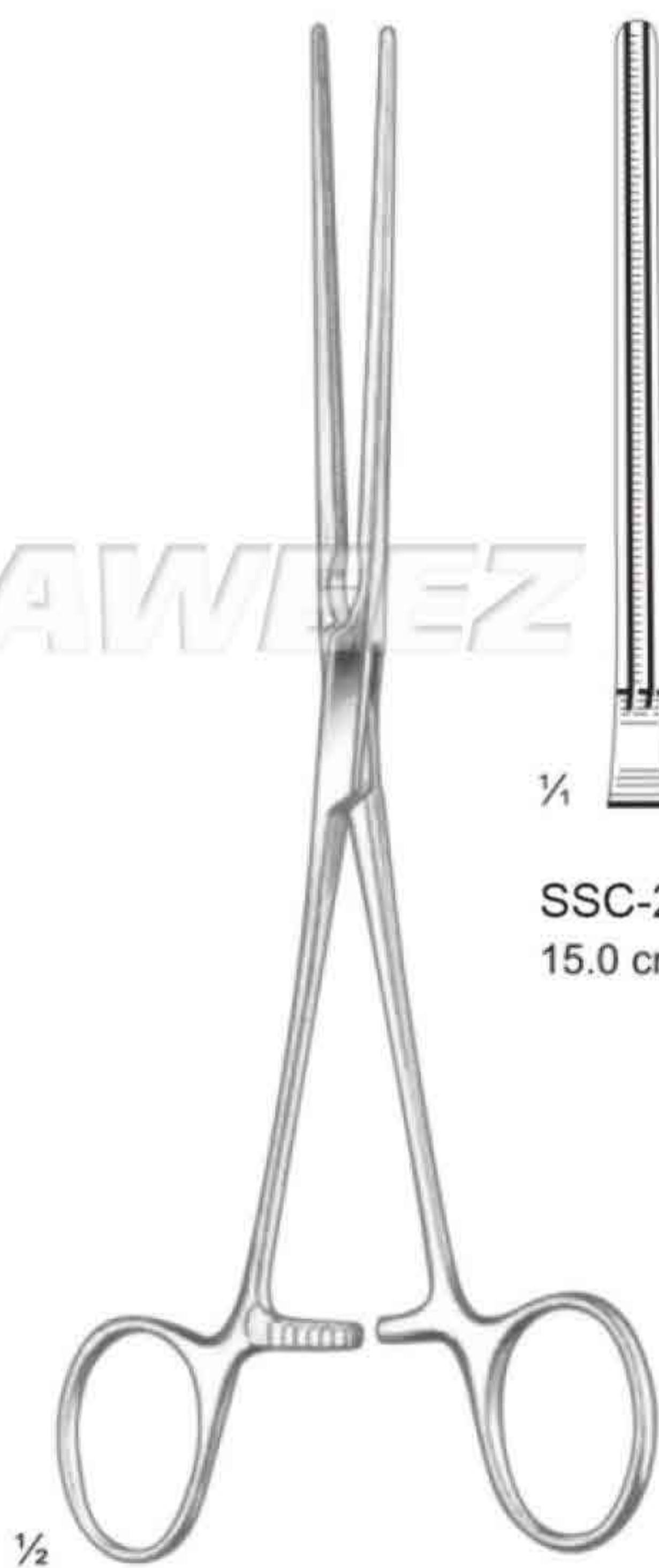
SSC-29-11-79
19.0 cm / 7 1/2"



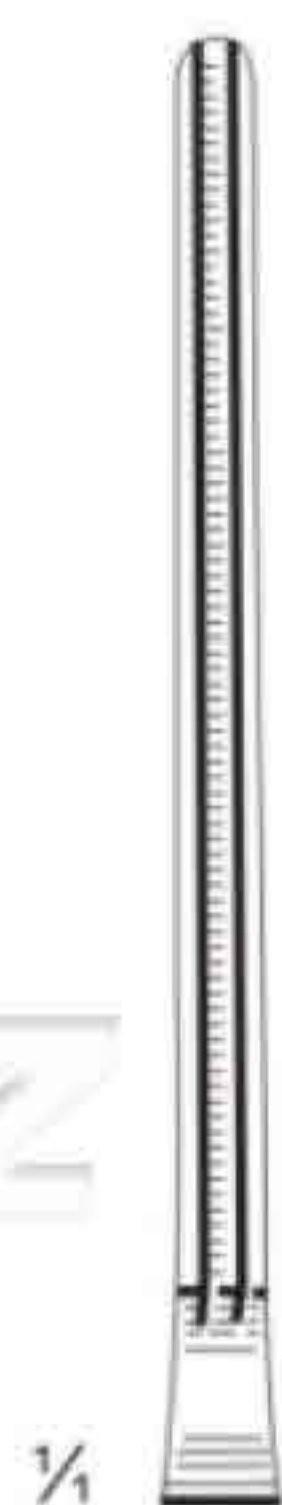
Dissecting and Ligature Forceps

SSC-29-11-80
23.0 cm / 9"





Bainbridge



SSC-29-11-87
15.0 cm / 6"



SSC-29-11-88
18.0 cm / 7"



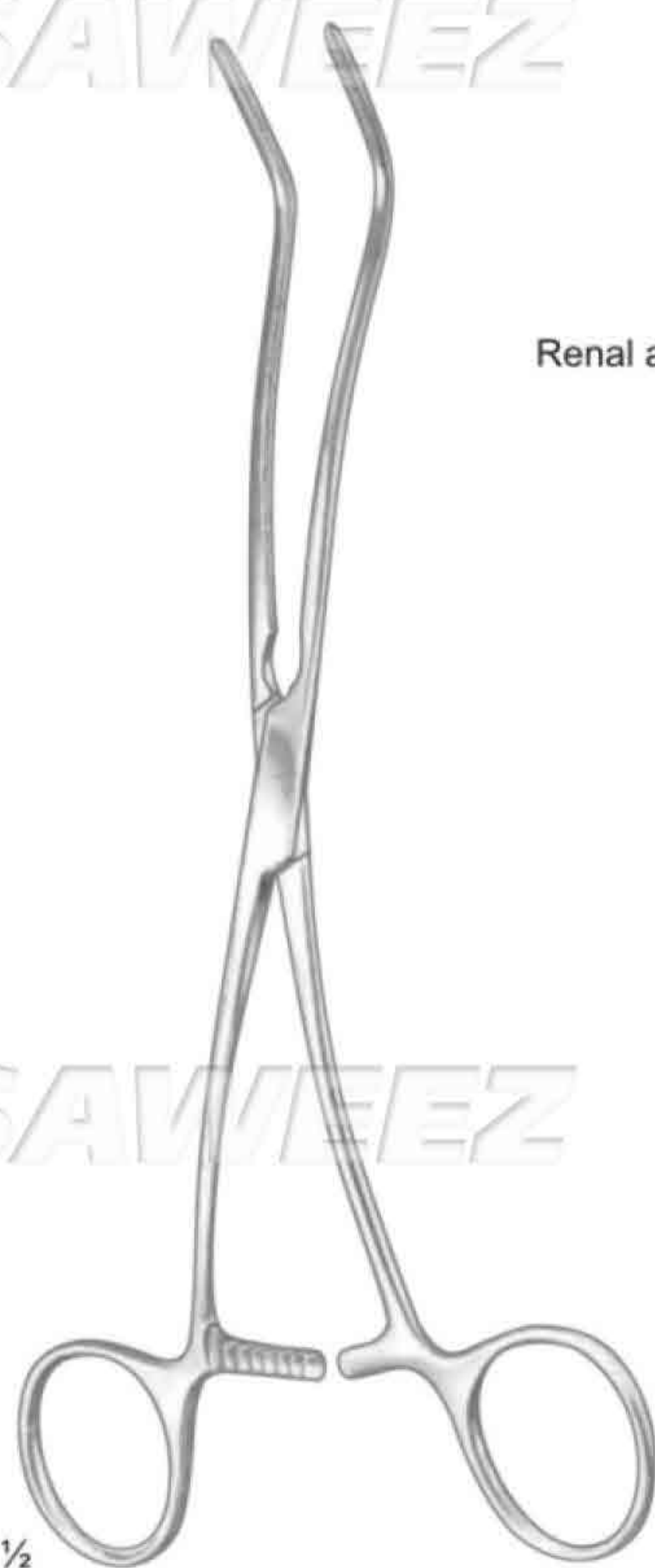
Bainbridge



SSC-29-11-89
15.0 cm / 6"

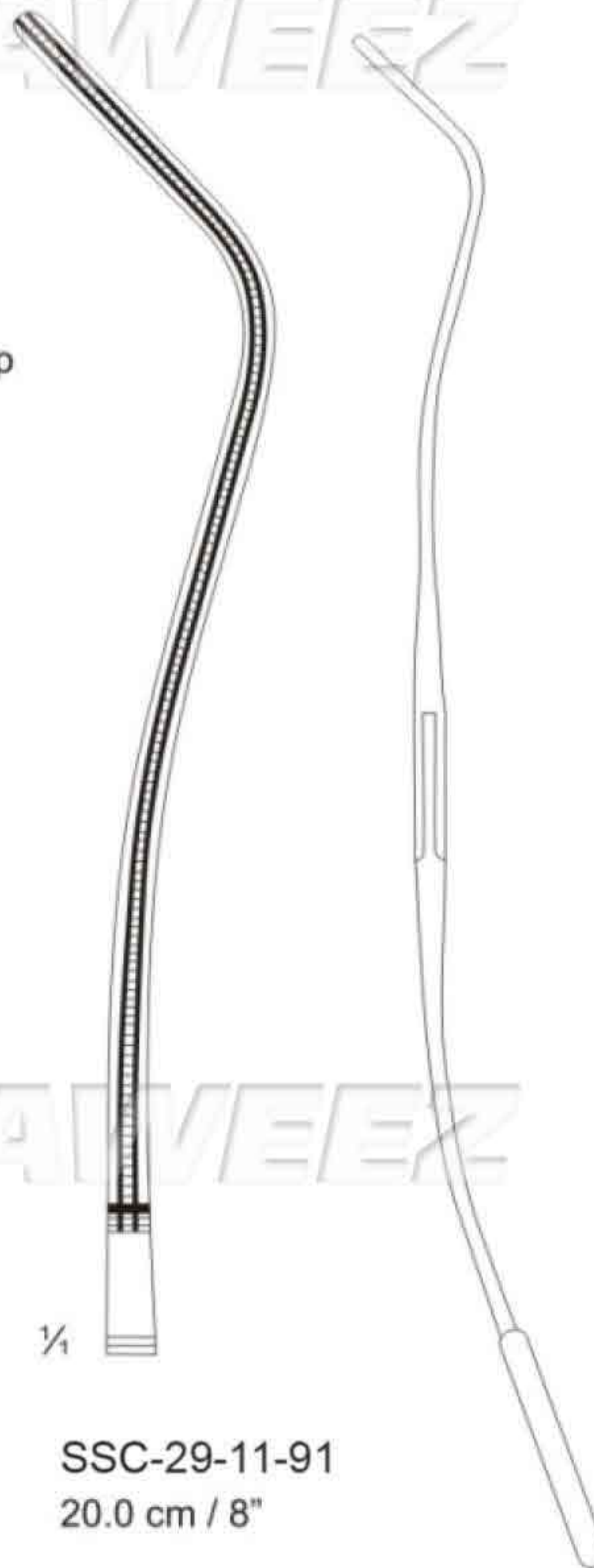


-29-11-90
18.0 cm / 7"



De Bakey

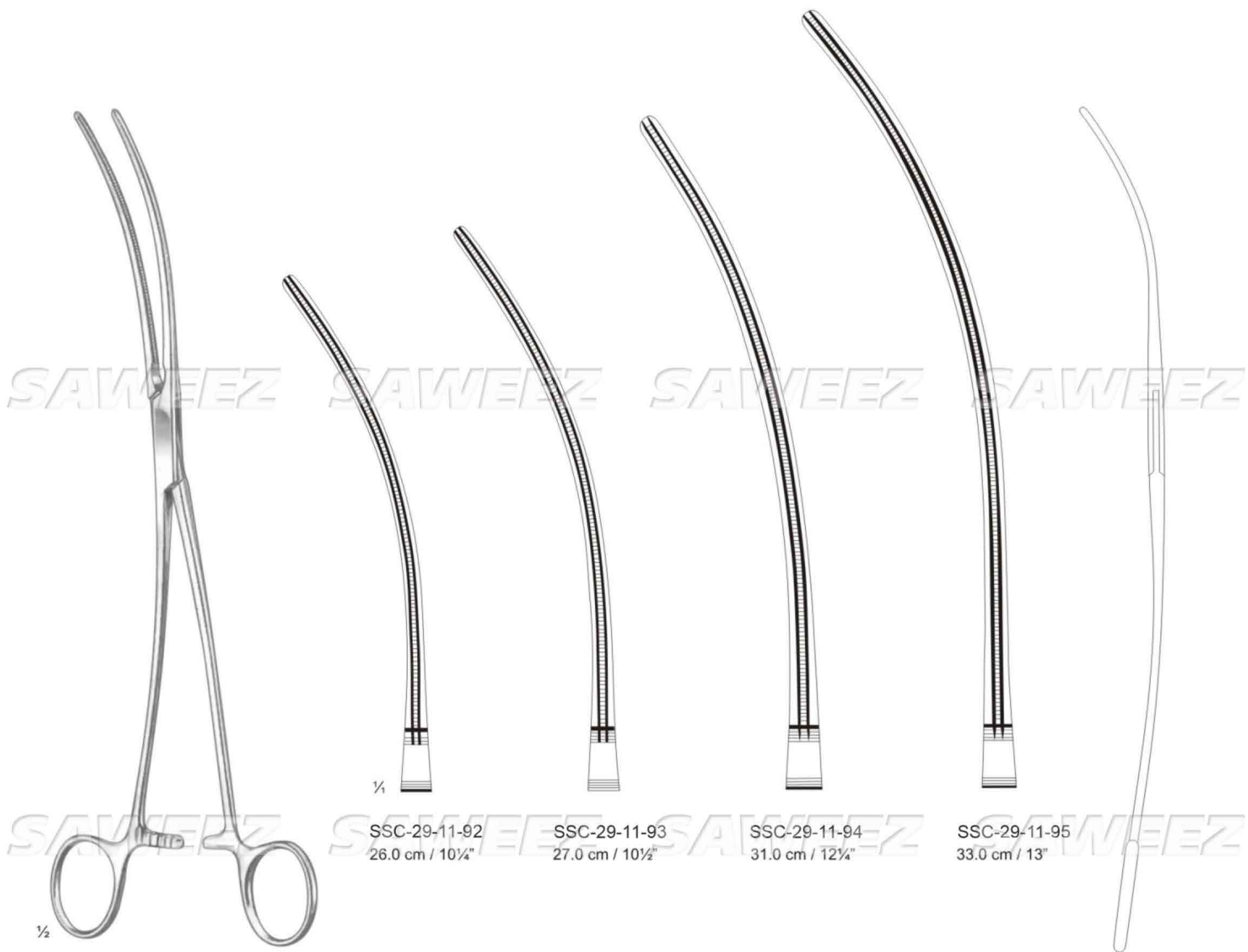
Renal artery clamp



SSC-29-11-91
20.0 cm / 8"



SAWEEZ SAWEEZ SAWEEZ SAWEEZ



Aortic aneurysm clamps



SAWEEZ SAWEEZ SAWEEZ SAWEEZ

SAWEEZ SAWEEZ SAWEEZ SAWEEZ

SAWEEZ SAWEEZ SAWEEZ SAWEEZ



De Bakey
SSC-29-11-96
28.0 cm / 11"



De Bakey
SSC-29-11-97
30.0 cm / 11 3/4"

Aortic aneurysm clamps



De Bakey
SSC-29-12-01
26.0 cm / 10 1/4"

Aortic clamp



De Bakey
SSC-29-12-02
25.0 cm / 10"

Ligature Forceps



1/2

Weber
SSC-29-12-03
26.0 cm / 10 1/4"

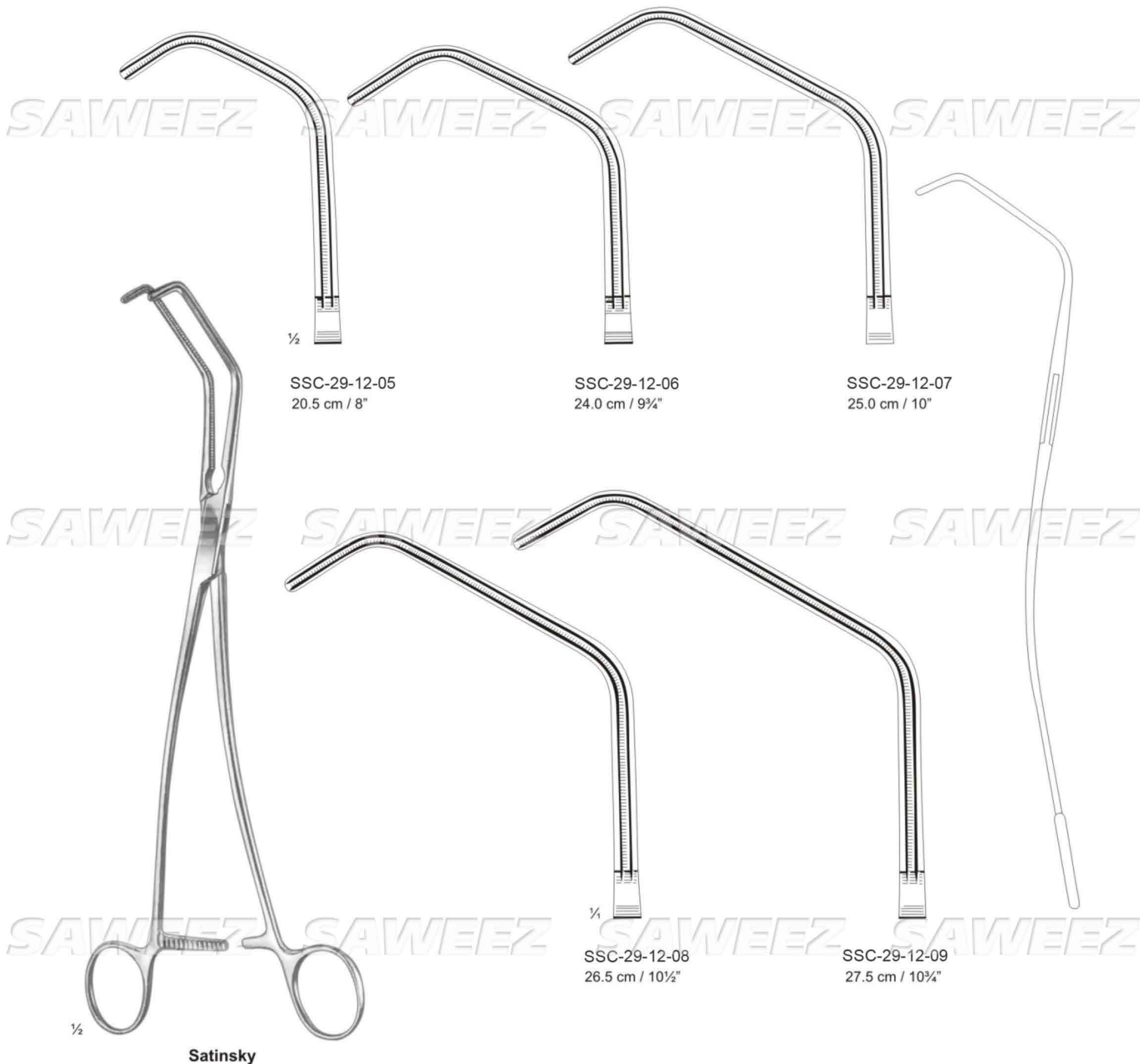
left

1/2

Weber
SSC-29-12-04
26.0 cm / 10 1/4"

right

Aortic clamps



Tangential occlusion clamps



1/2

Harken



1/4

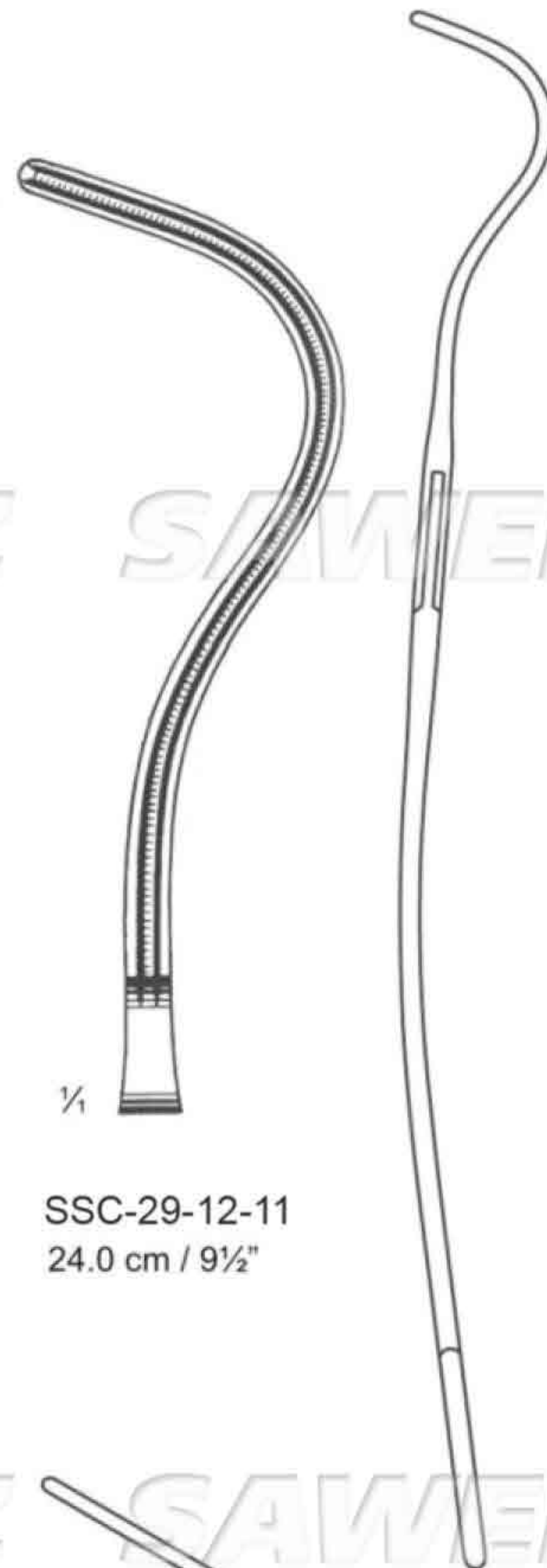
SSC-29-12-10
24.0 cm / 9 1/2"

Auricle clamps



1/4

SSC-29-12-11
24.0 cm / 9 1/2"



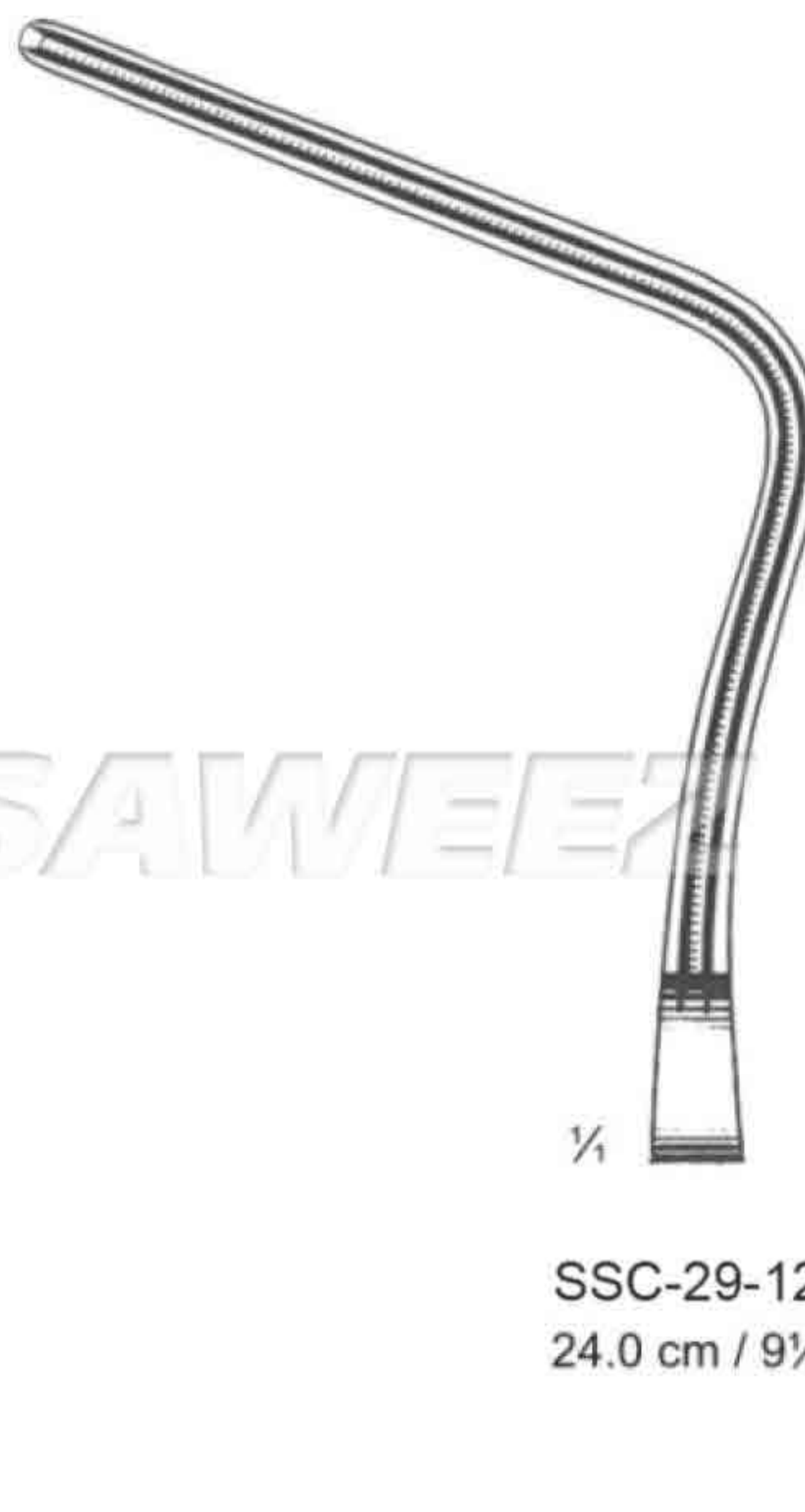
1/4

SSC-29-12-12
24.0 cm / 9 1/2"



1/4

SSC-29-12-13
24.0 cm / 9 1/2"





Bronchus clamps



Lambert-Kay

SSC-29-12-17

SSC-29-12-18



De Bakey

SSC-29-12-19
17.0 cm / 6 3/4"



SAWEEZ SAWEEZ SAWEEZ SAWEEZ



SSC-29-12-20
18.0 cm / 7"

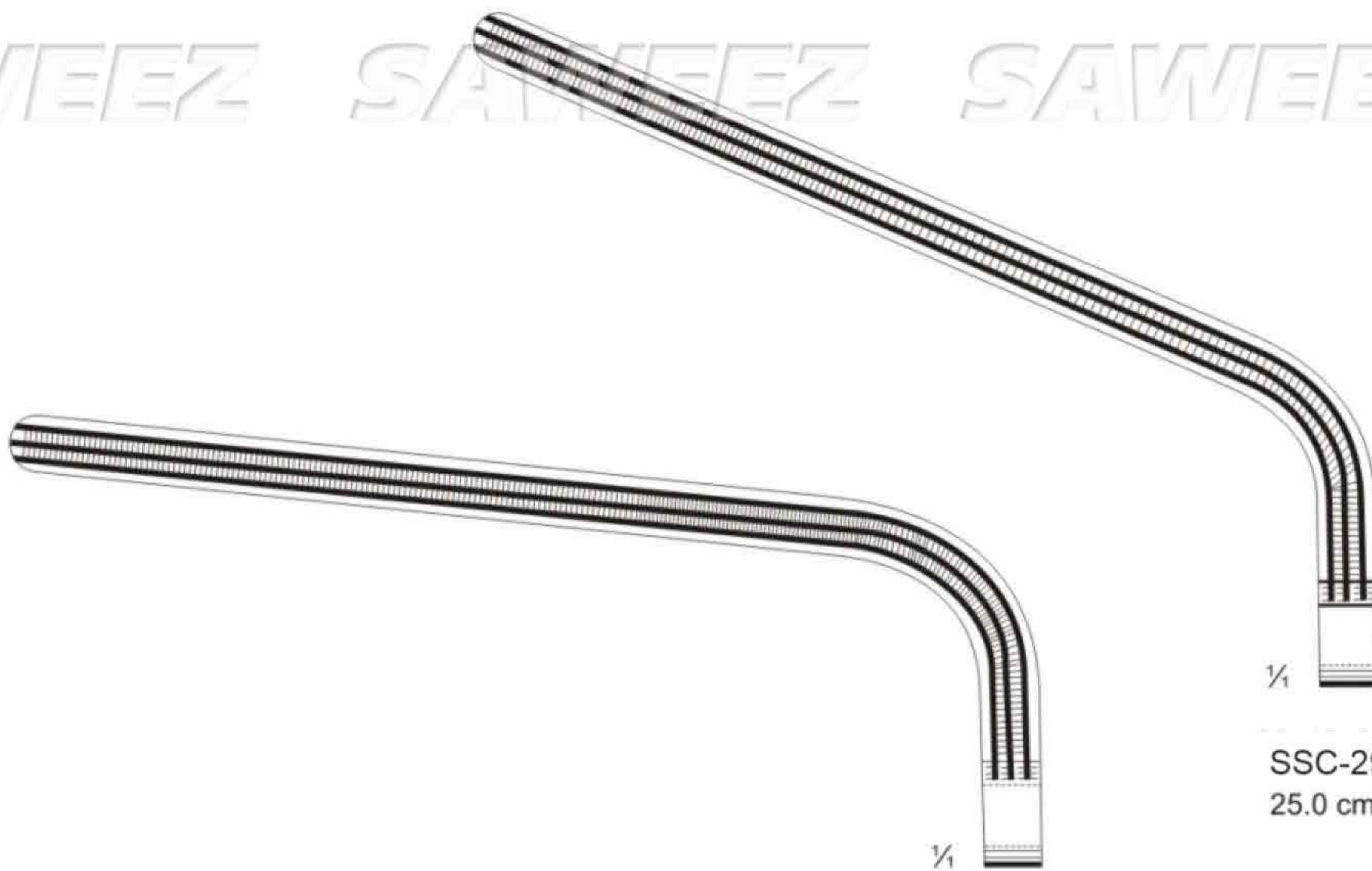


SSC-29-12-21
20.0 cm / 8"

SAWEEZ SAWEEZ SAWEEZ SAWEEZ



Morris-De Bakey



SSC-29-12-23
25.0 cm / 10"

SAWEEZ SAWEEZ SAWEEZ SAWEEZ

SSC-29-12-22
23.0 cm / 9"

Aortic clamps

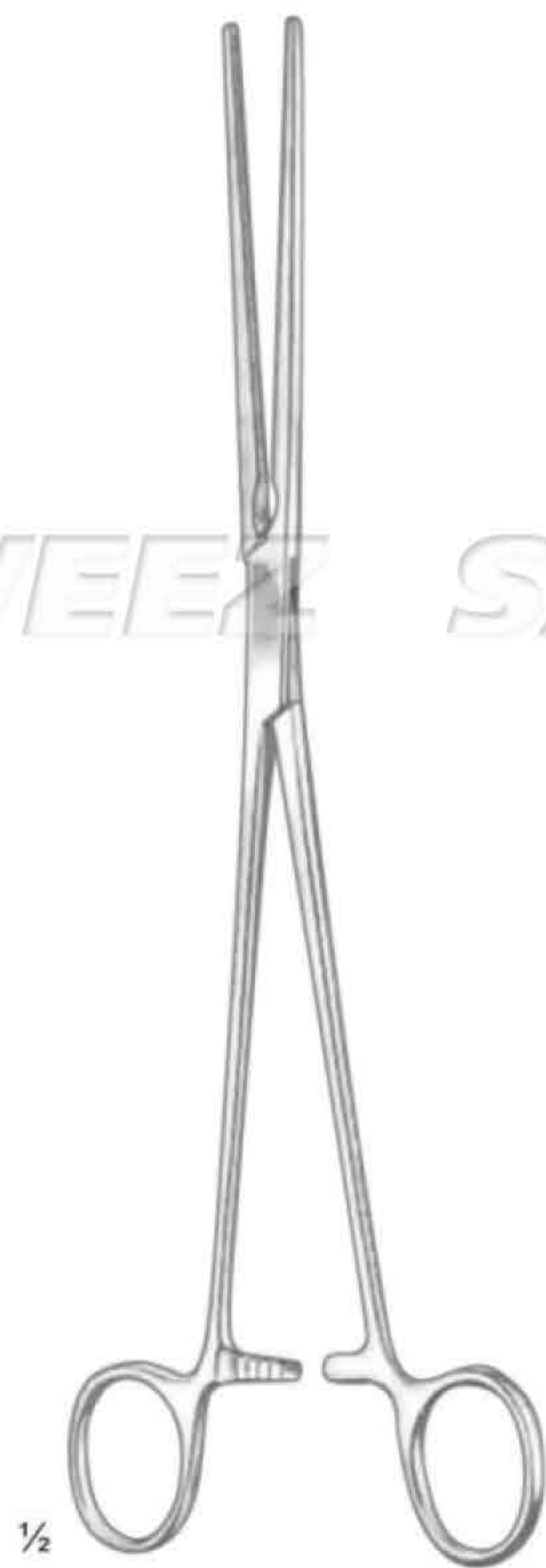


SAWEEZ SAWEEZ SAWEEZ SAWEEZ

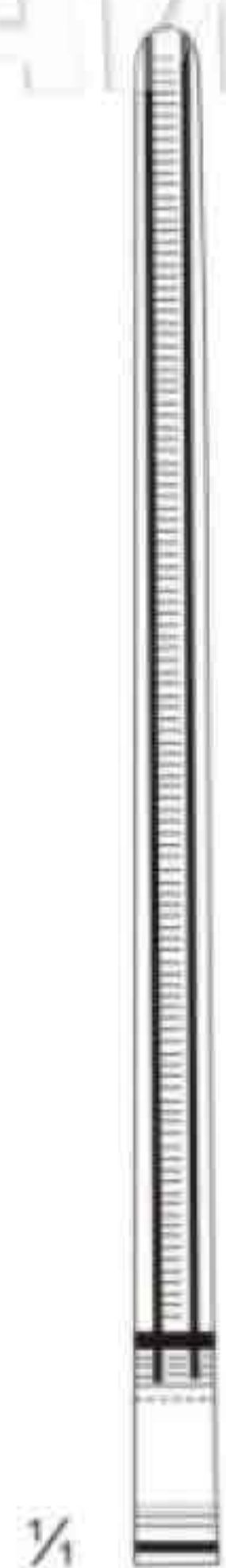


De Bakey-Bahnson

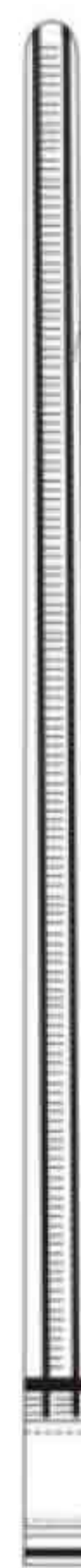
Aortic aneurysm clamps/iliac artery



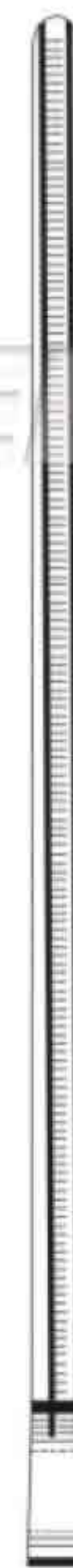
1/2



SSC-29-12-27
21.5 cm / 8 1/2"



SSC-29-12-28
23.0 cm / 9"



SSC-29-12-29
27.0 cm / 10 1/2"



SSC-29-12-30
31.5 cm / 12 1/2"



1/2

Coarctation clamps



SSC-29-12-31
21.5 cm / 8 1/2"



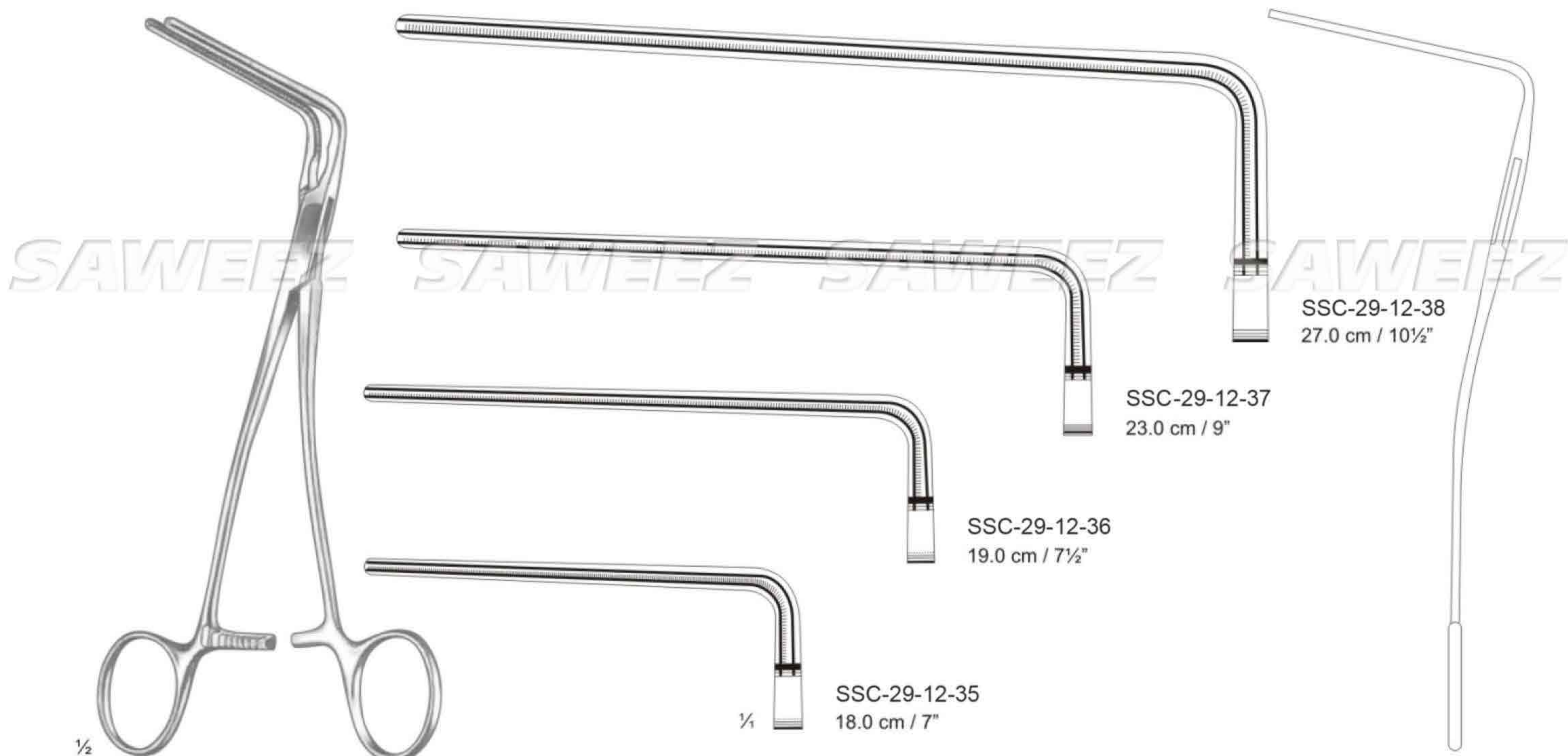
SSC-29-12-32
23.0 cm / 9"



SSC-29-12-33
27.0 cm / 10 1/2"

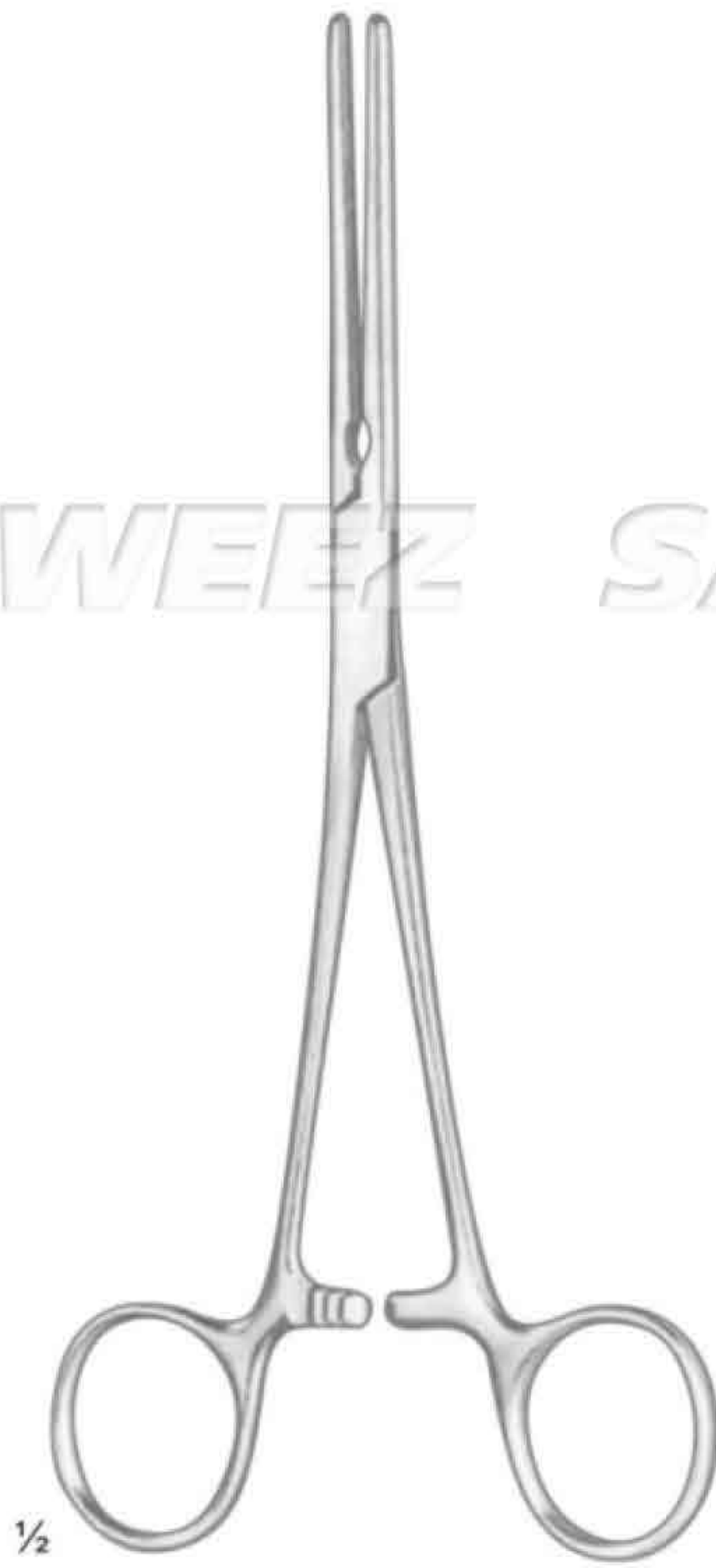


SSC-29-12-34
21.5 cm / 8 1/2"



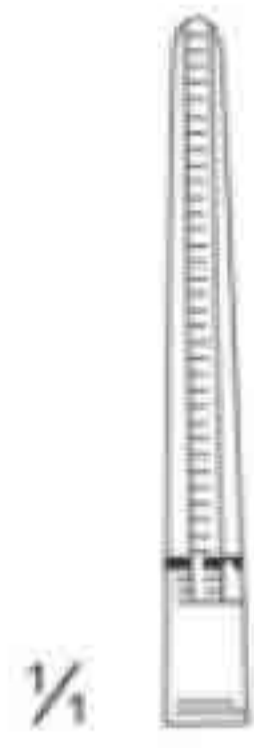
De Bakey



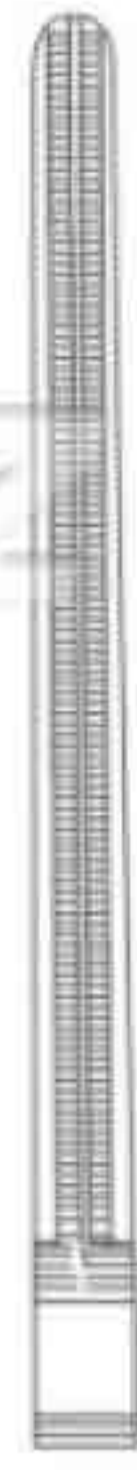


1/2

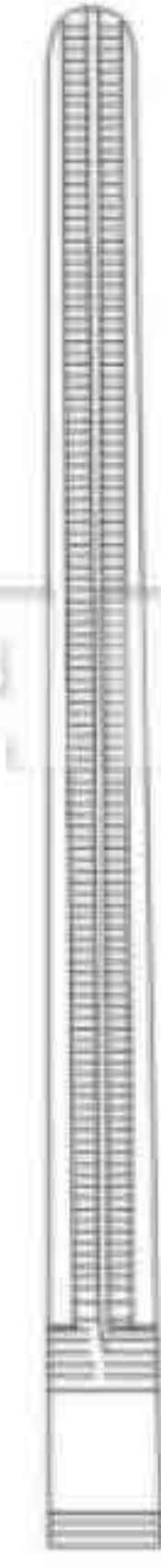
De Bakey-Pean



SSC-29-12-43
12.0 cm / 4 3/4"



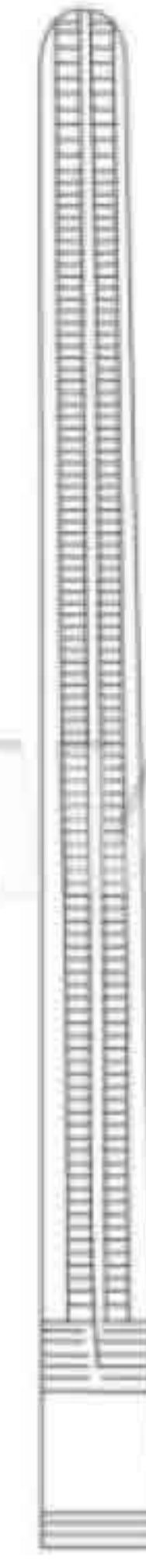
SSC-29-12-44
14.0 cm / 5 1/2"



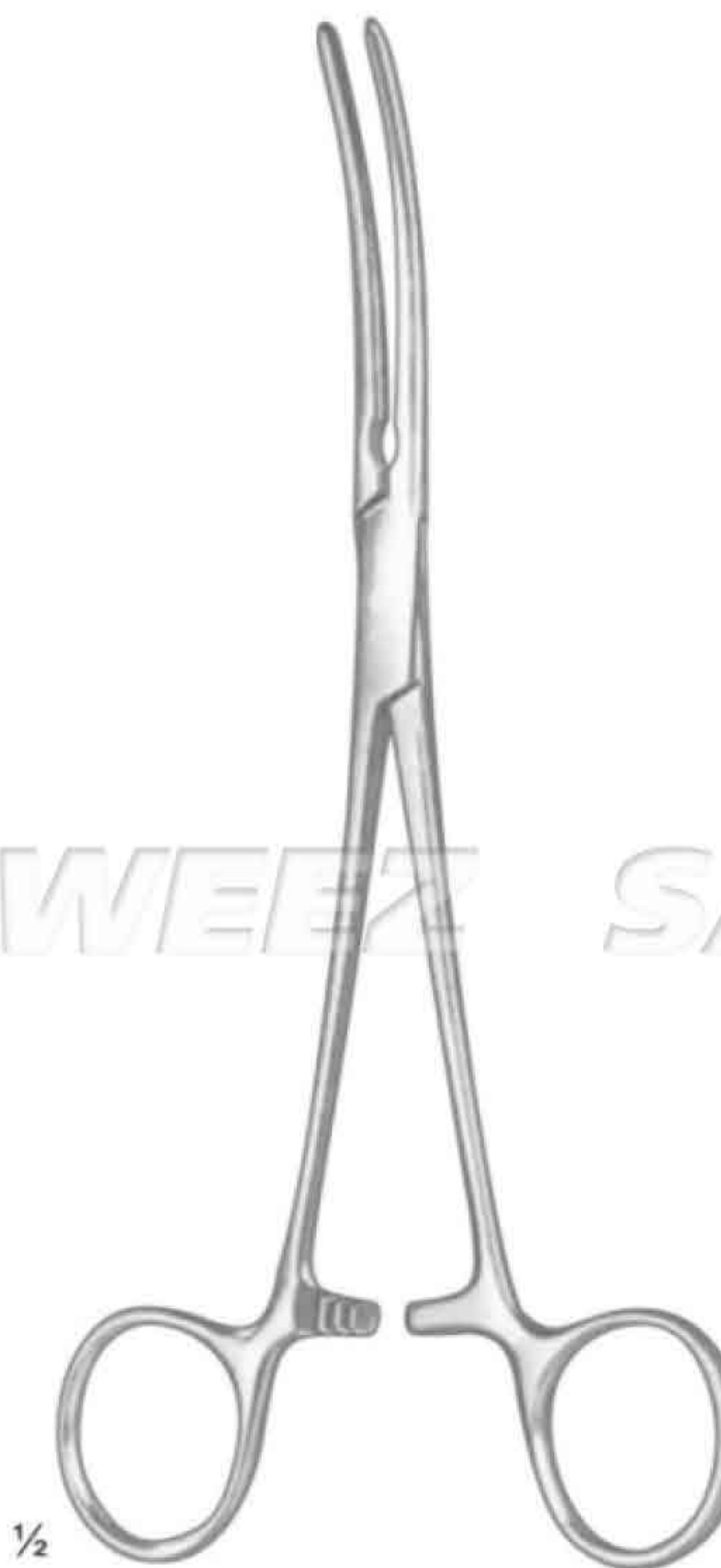
SSC-29-12-45
16.0 cm / 6 1/4"



SSC-29-12-46
18.0 cm / 7"



SSC-29-12-47
20.0 cm / 8"

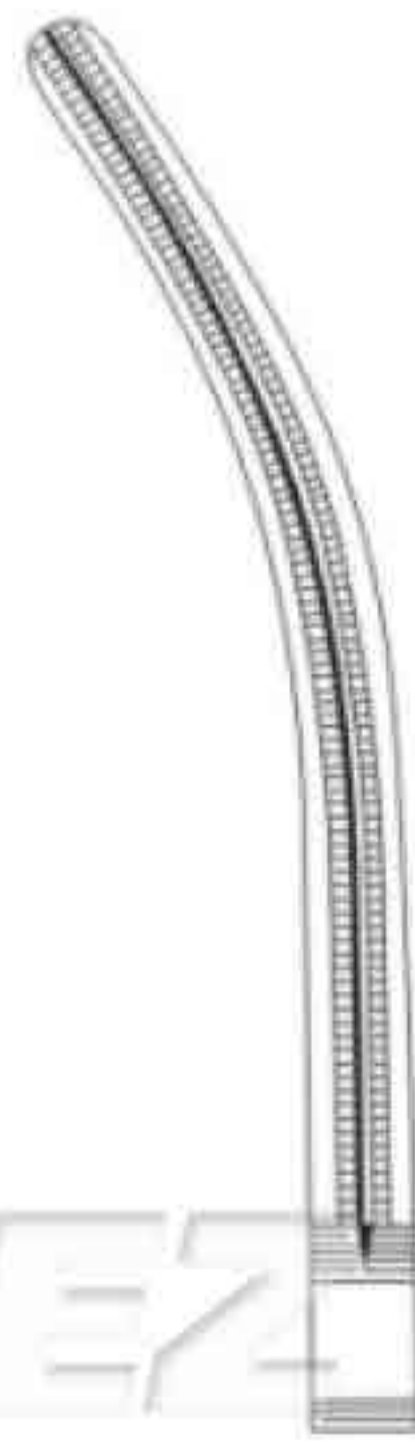


1/2

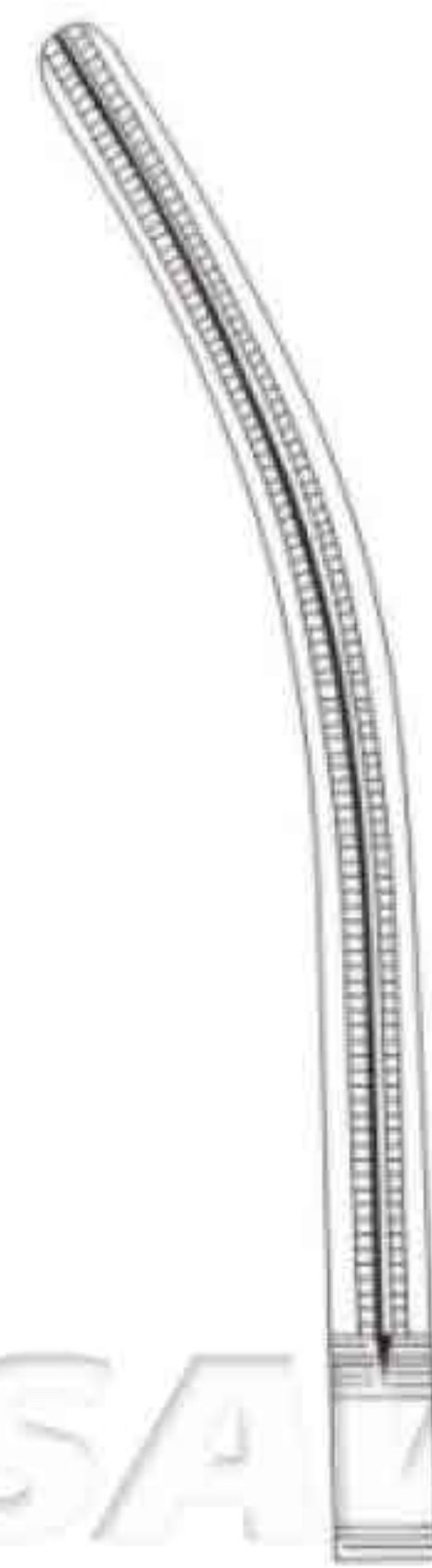
De Bakey-Pean



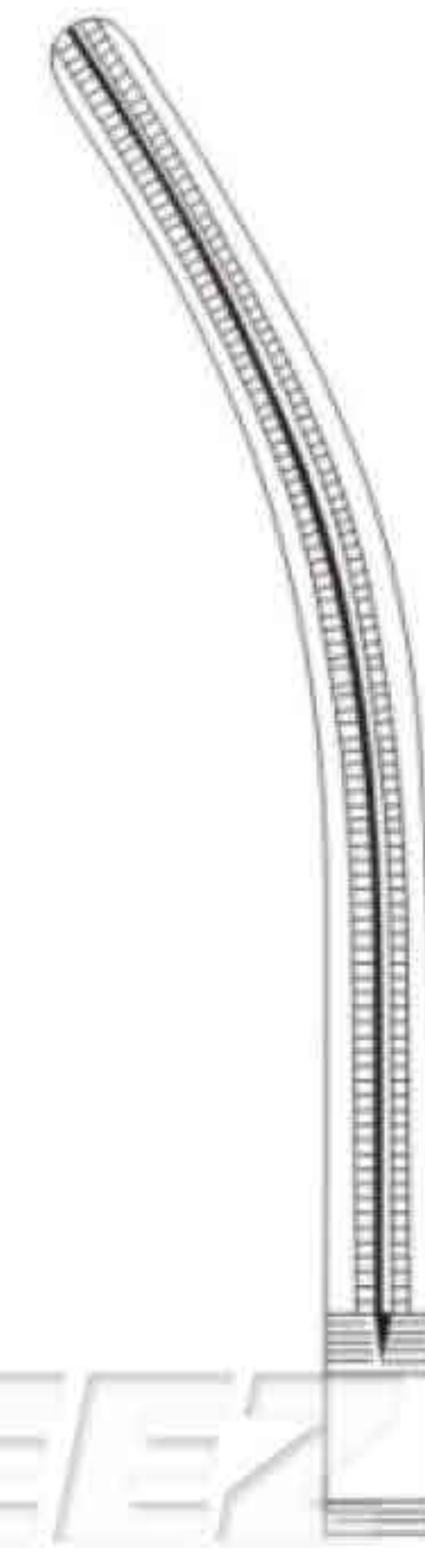
SSC-29-12-48
12.0 cm / 4 3/4"



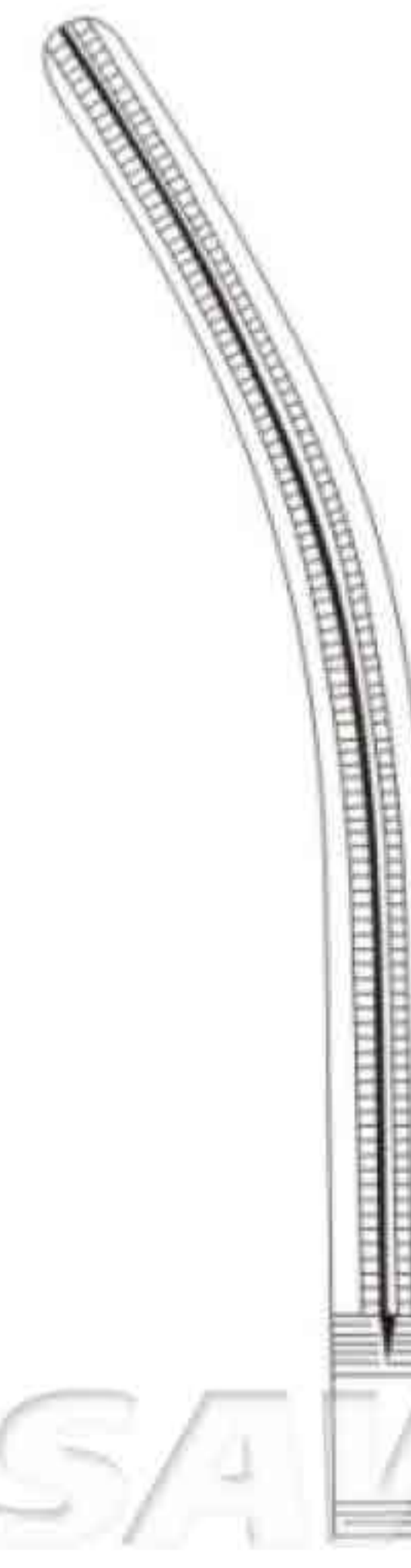
SSC-29-12-49
14.0 cm / 5 1/2"



SSC-29-12-50
16.0 cm / 6 1/4"



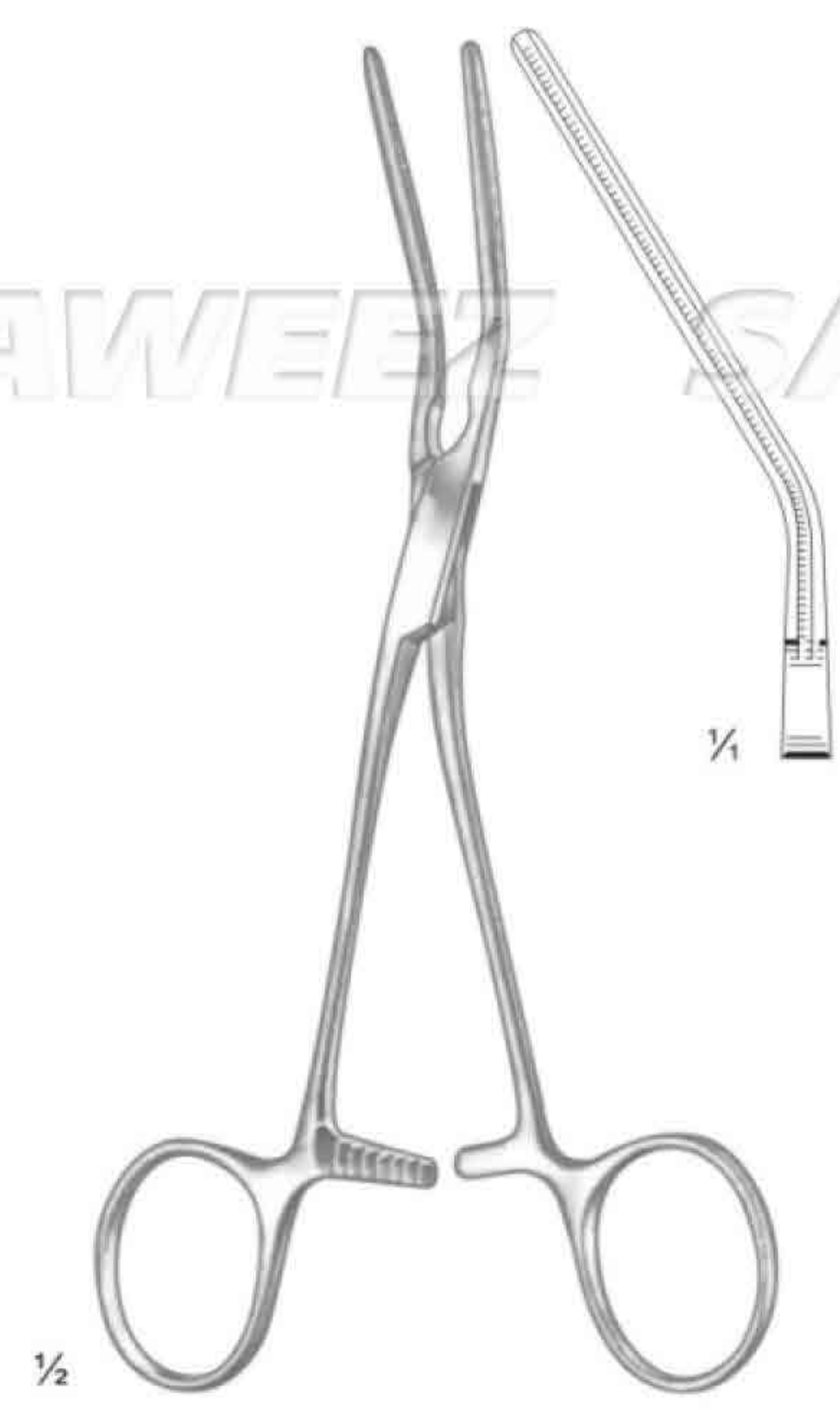
SSC-29-12-51
18.0 cm / 7"



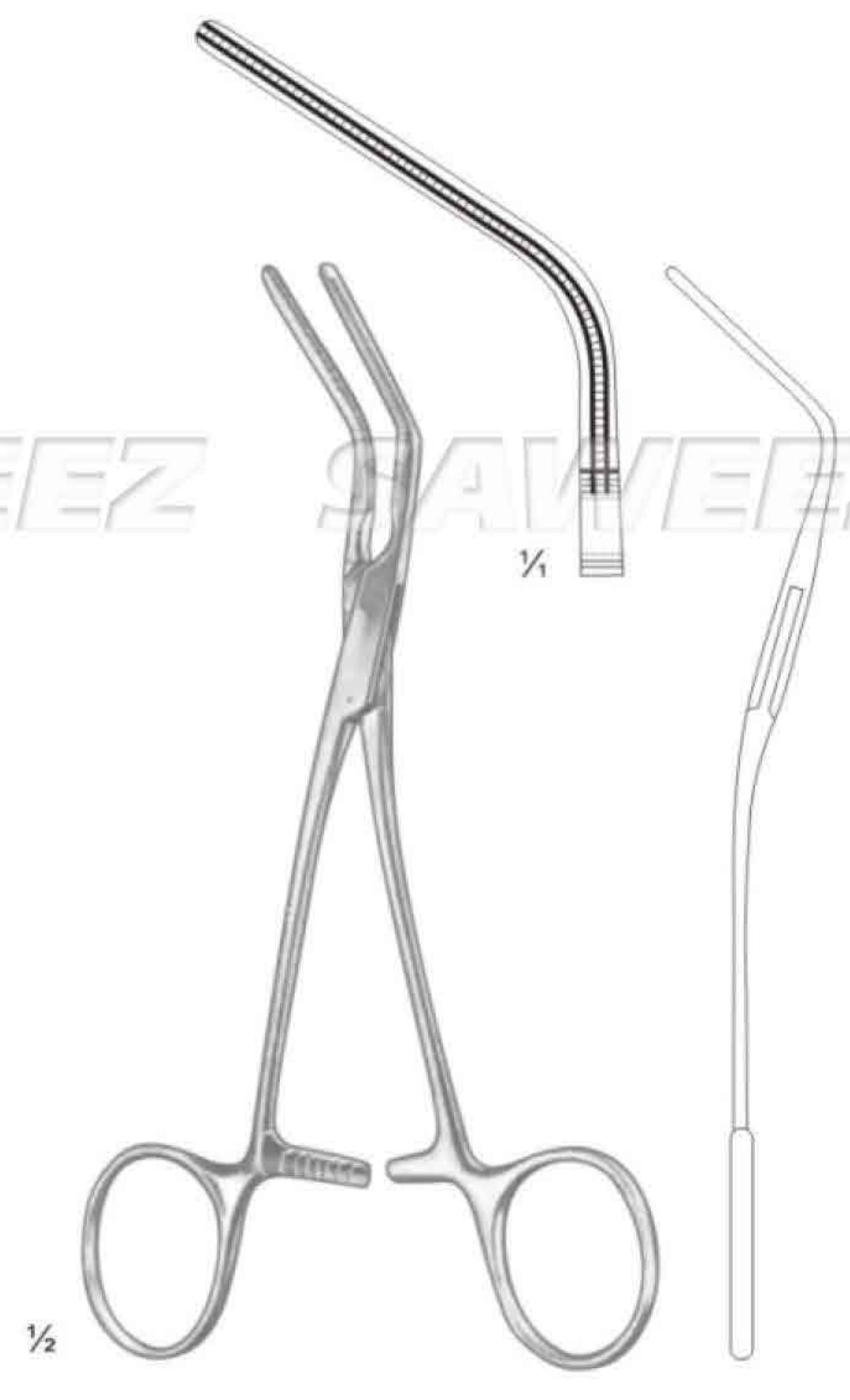
SSC-29-12-52
20.0 cm / 8"



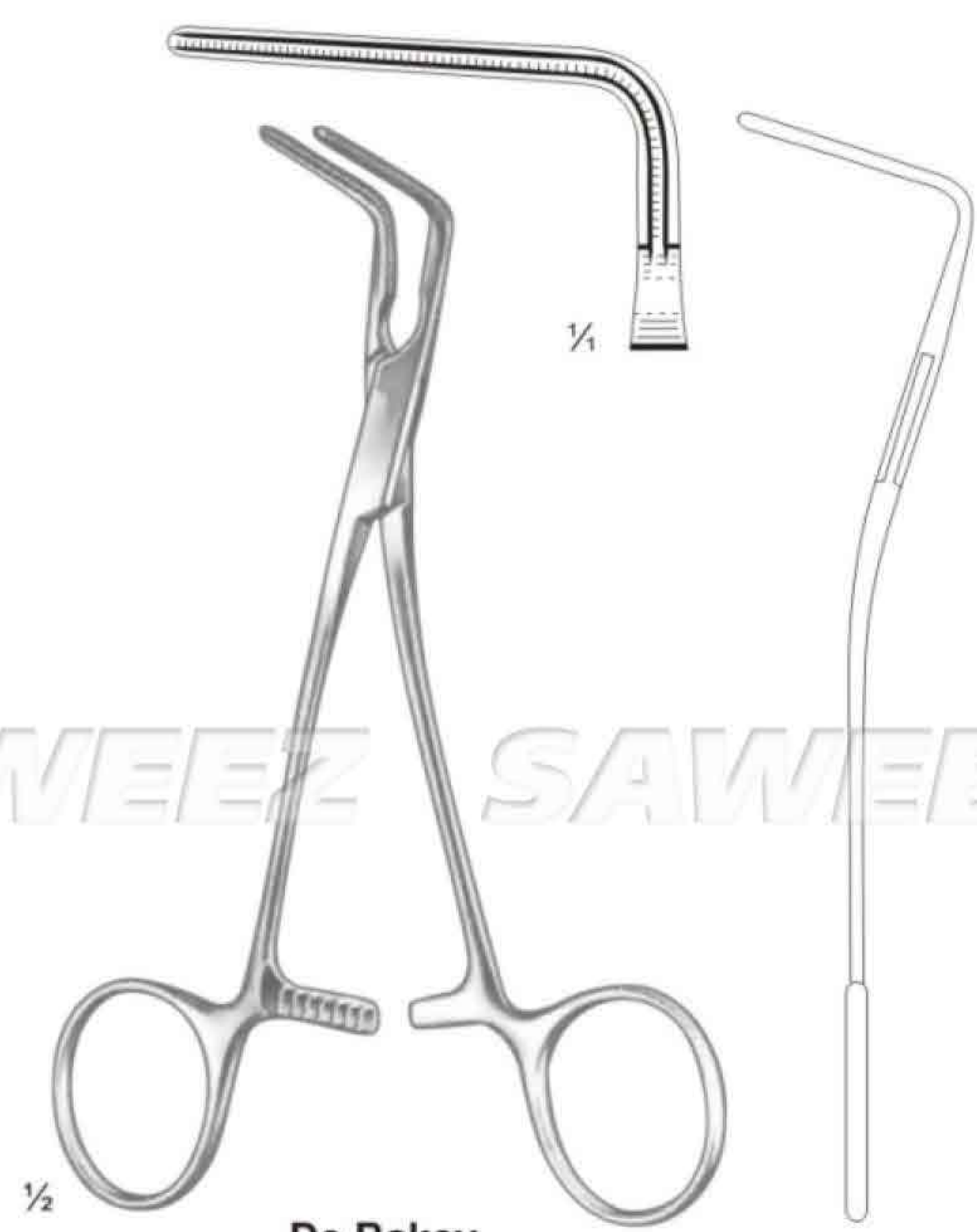
De Bakey
SSC-29-12-53
17.0 cm / 6 3/4"



De Bakey
SSC-29-12-54
16.0 cm / 6 1/4"



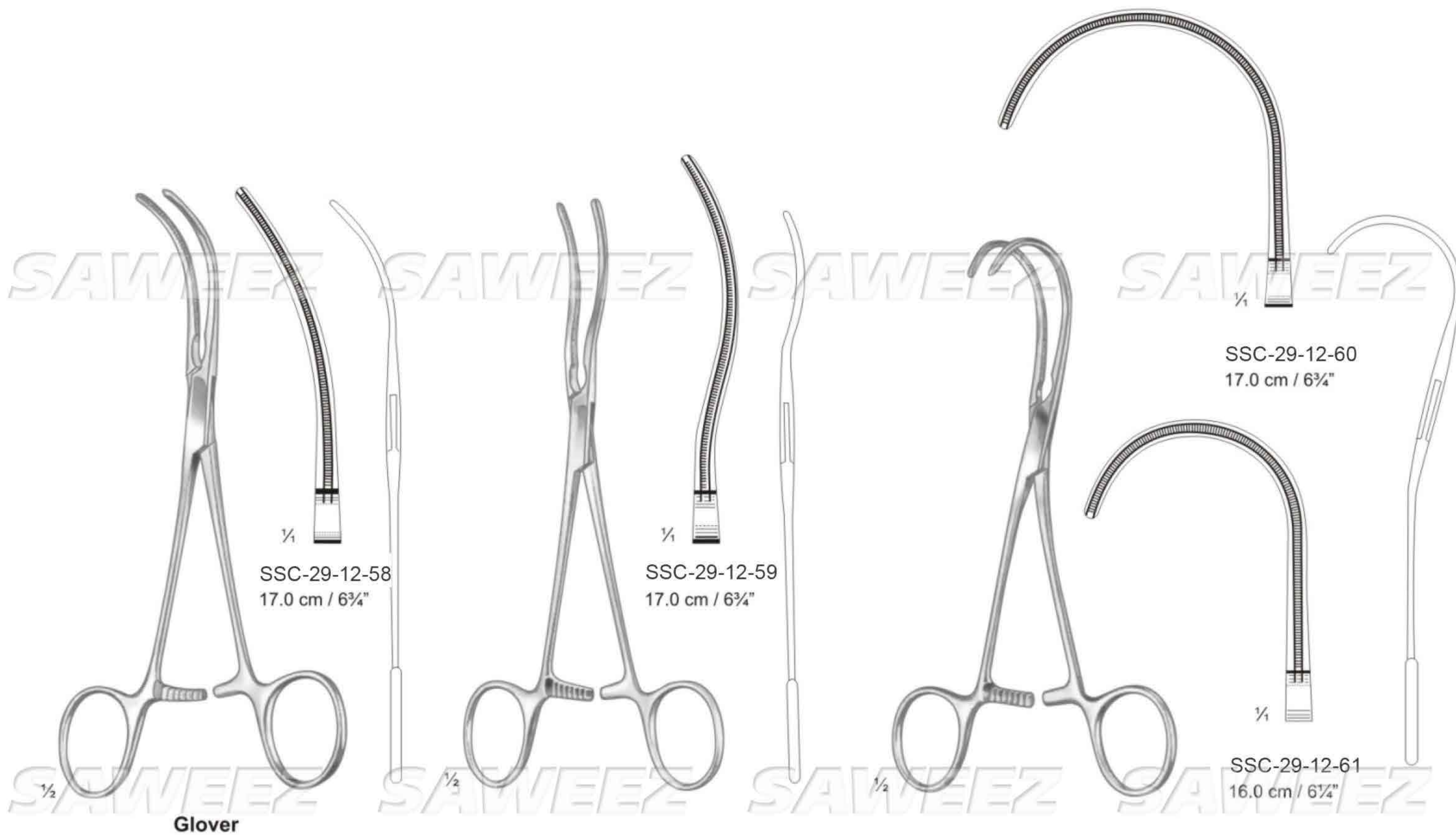
De Bakey
SSC-29-12-55
15.0 cm / 6"

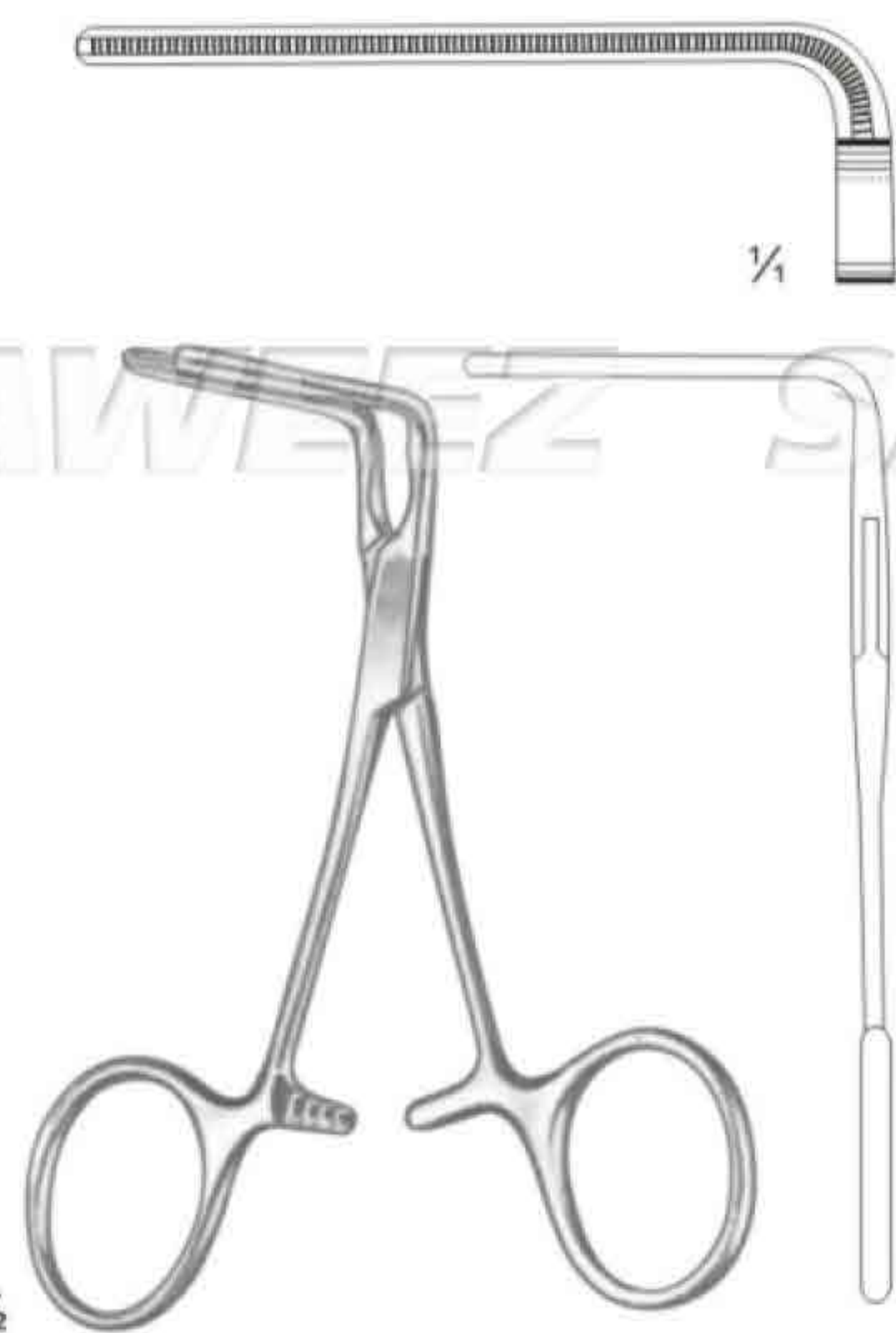


De Bakey
SSC-29-12-56
15.0 cm / 6"

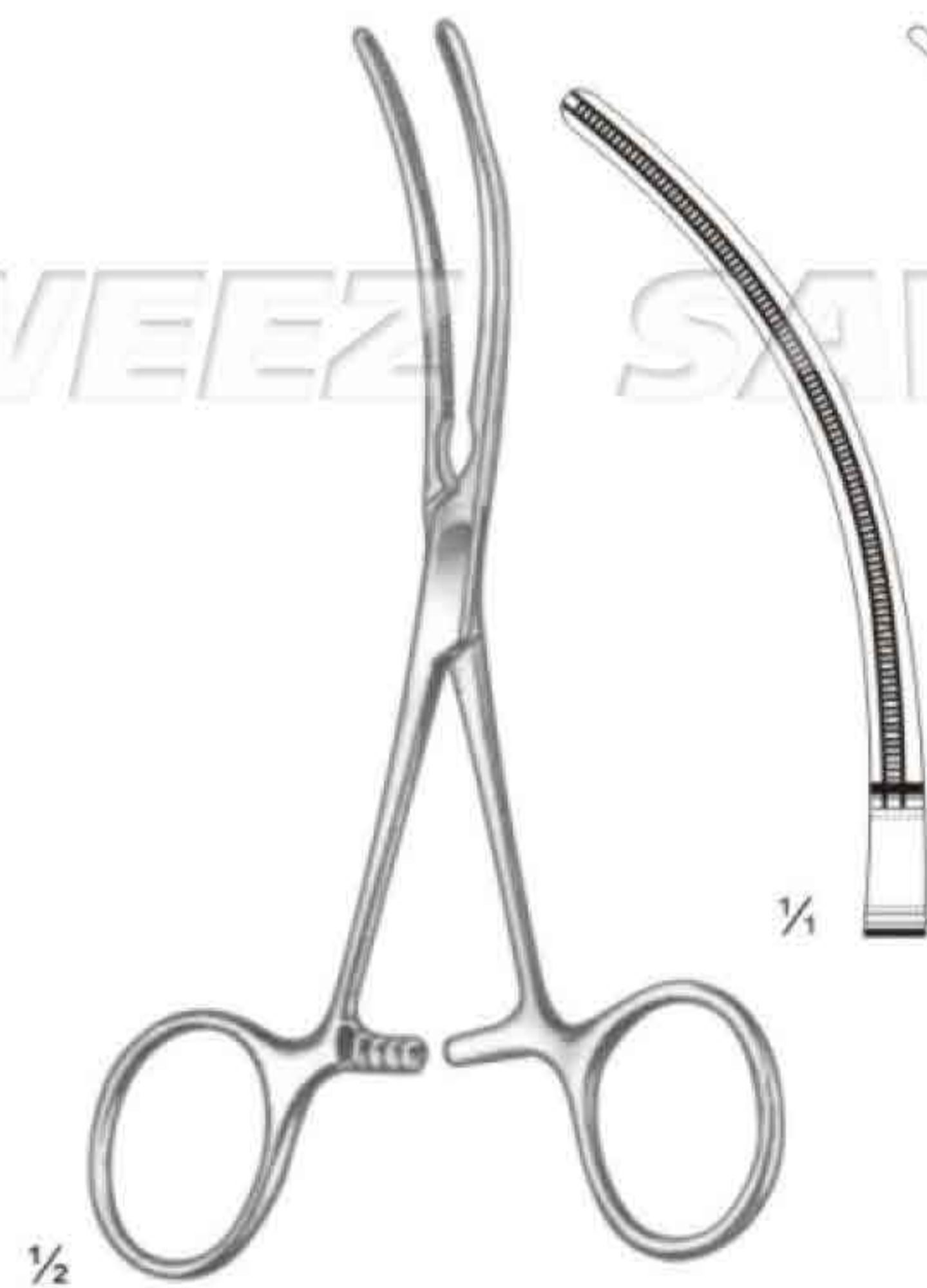


De Bakey
SSC-29-12-57
17.0 cm / 6 3/4"

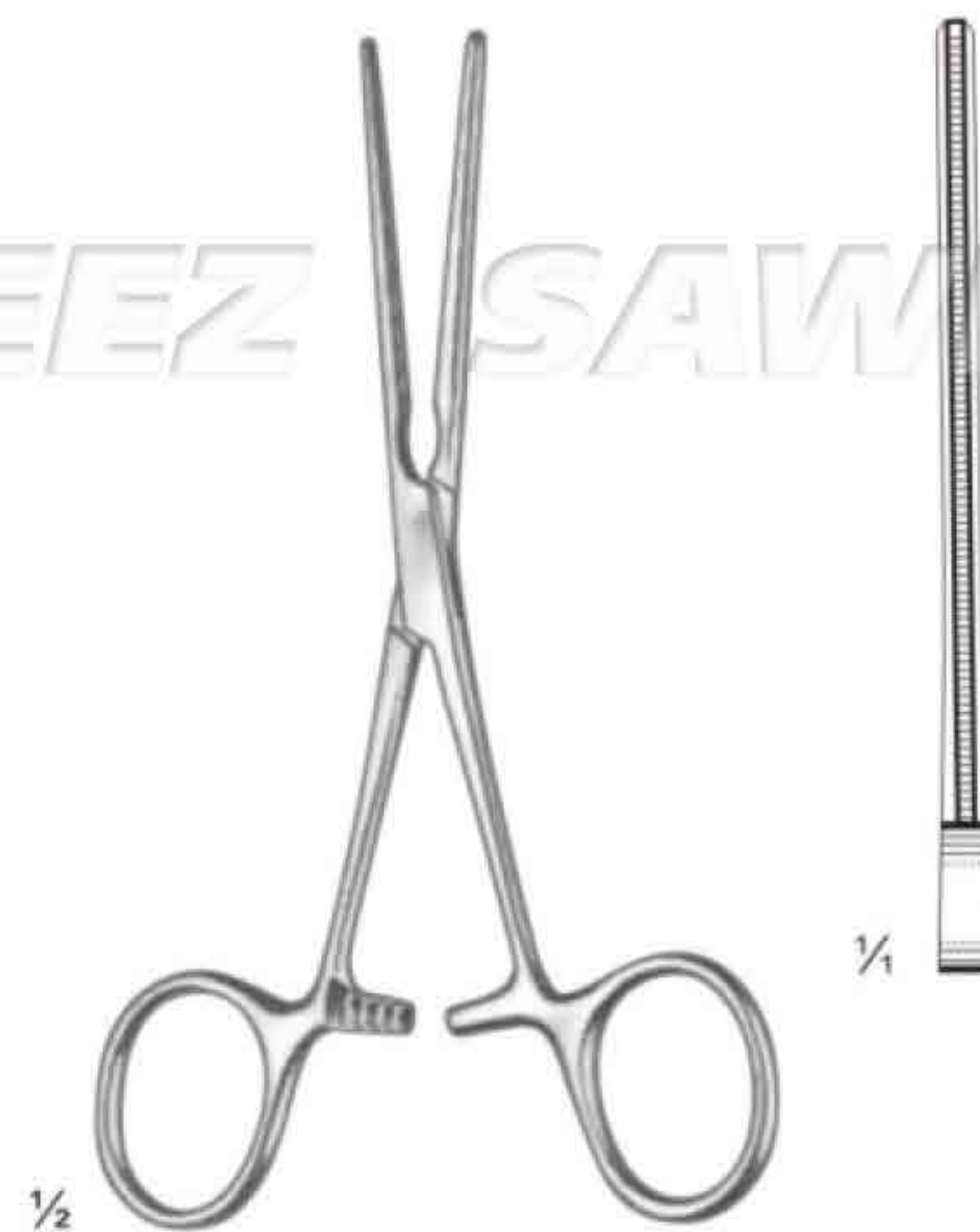




De Bakey
SSC-29-12-66
10.0 cm / 4"



De Bakey
SSC-29-12-67
11.0 cm / 4 1/4"



De Bakey
SSC-29-12-68
12.0 cm / 4 3/4"

SAWEEZ SAWEEZ SAWEEZ SAWEEZ



De Bakey
SSC-29-12-69
12.0 cm / 4 3/4"



De Bakey
SSC-29-12-70
13.0 cm / 5 1/4"

SAWEEZ SAWEEZ SAWEEZ SAWEEZ



SSC-29-12-71
14.0 cm / 5 1/2"

Cooley



1/4



SSC-29-12-73
14.0 cm / 5 1/2"

Cooley



1/4

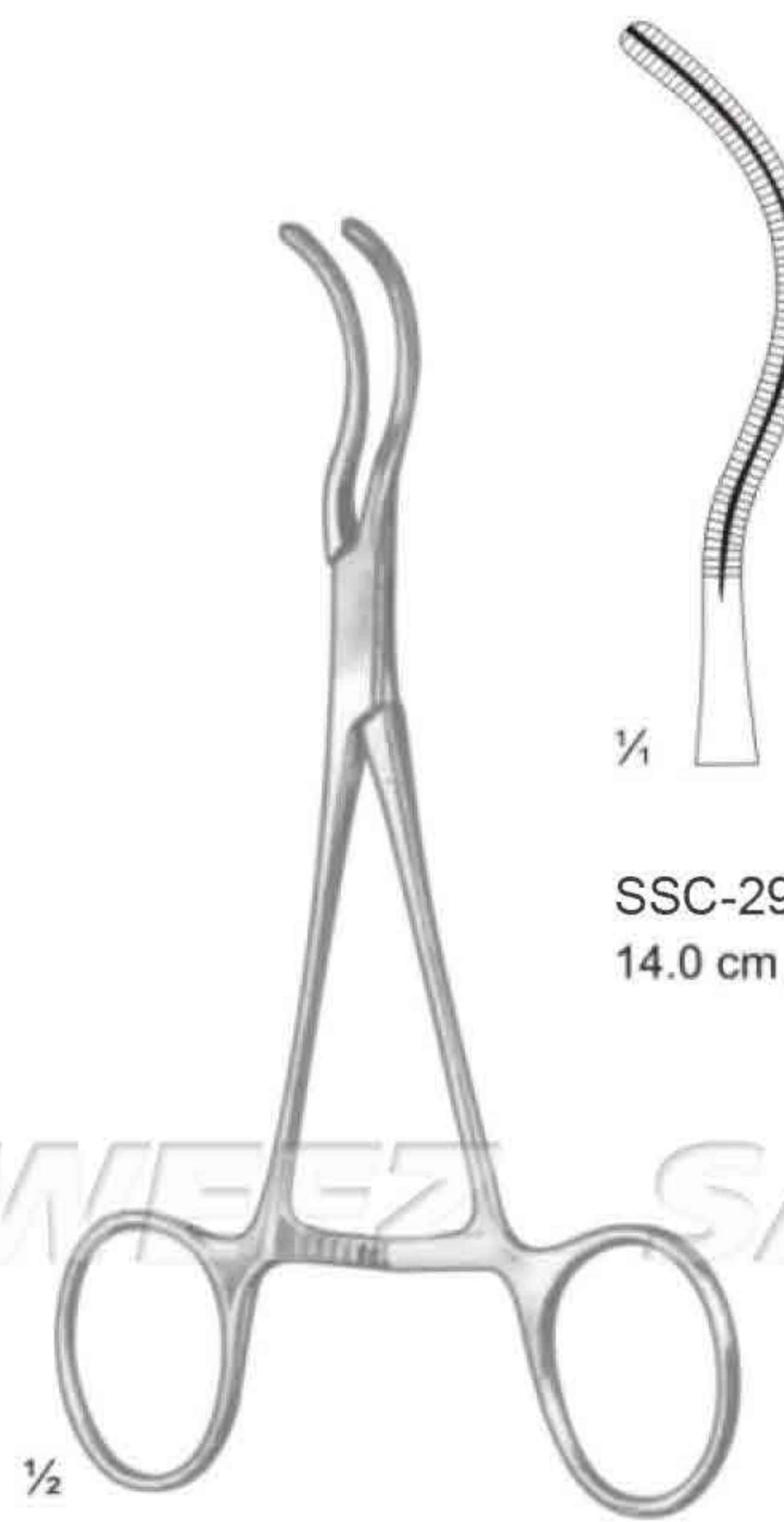


SSC-29-12-74
14.0 cm / 5 1/2"

Cooley



1/4



SSC-29-12-75
14.0 cm / 5 1/2"

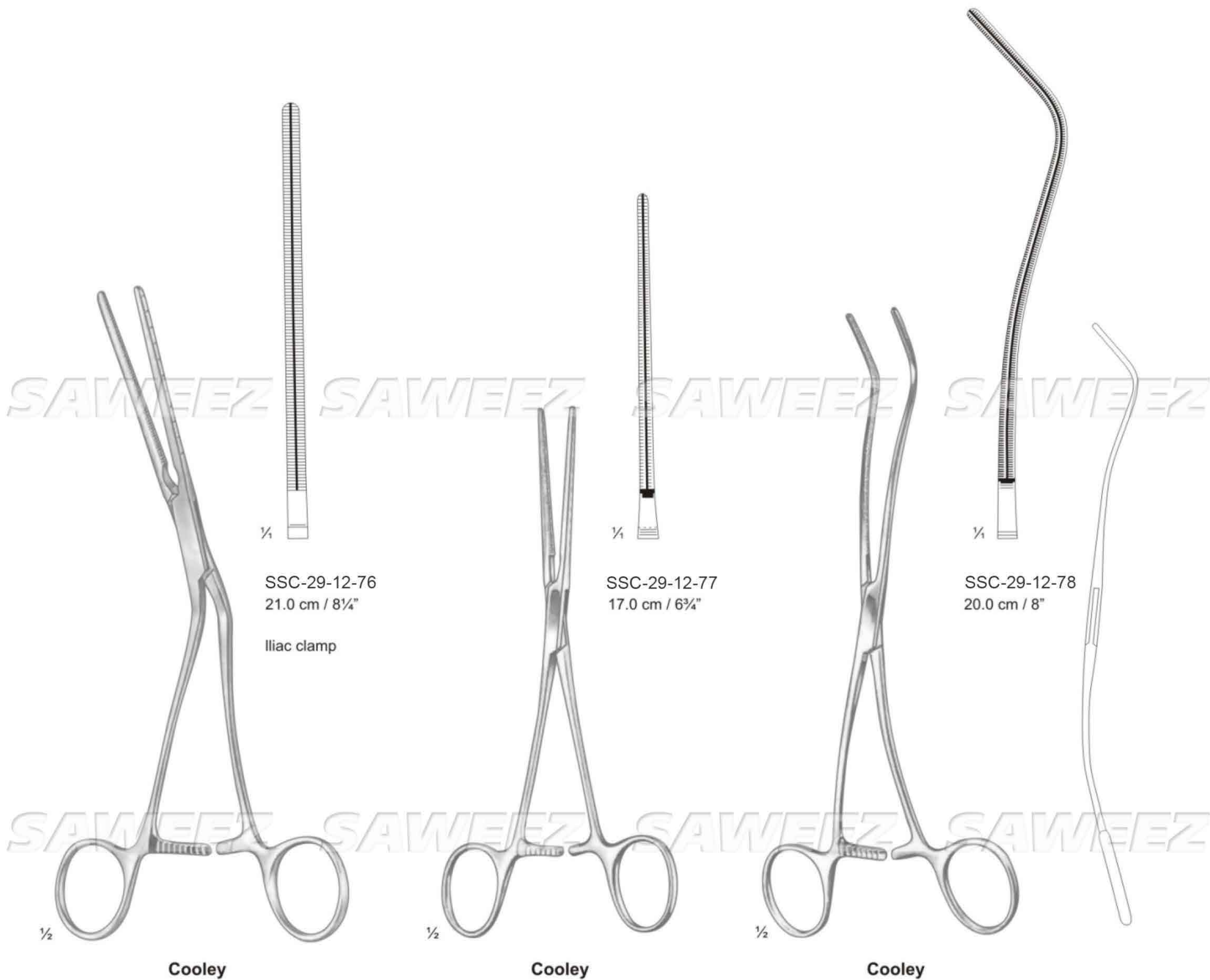
Cooley

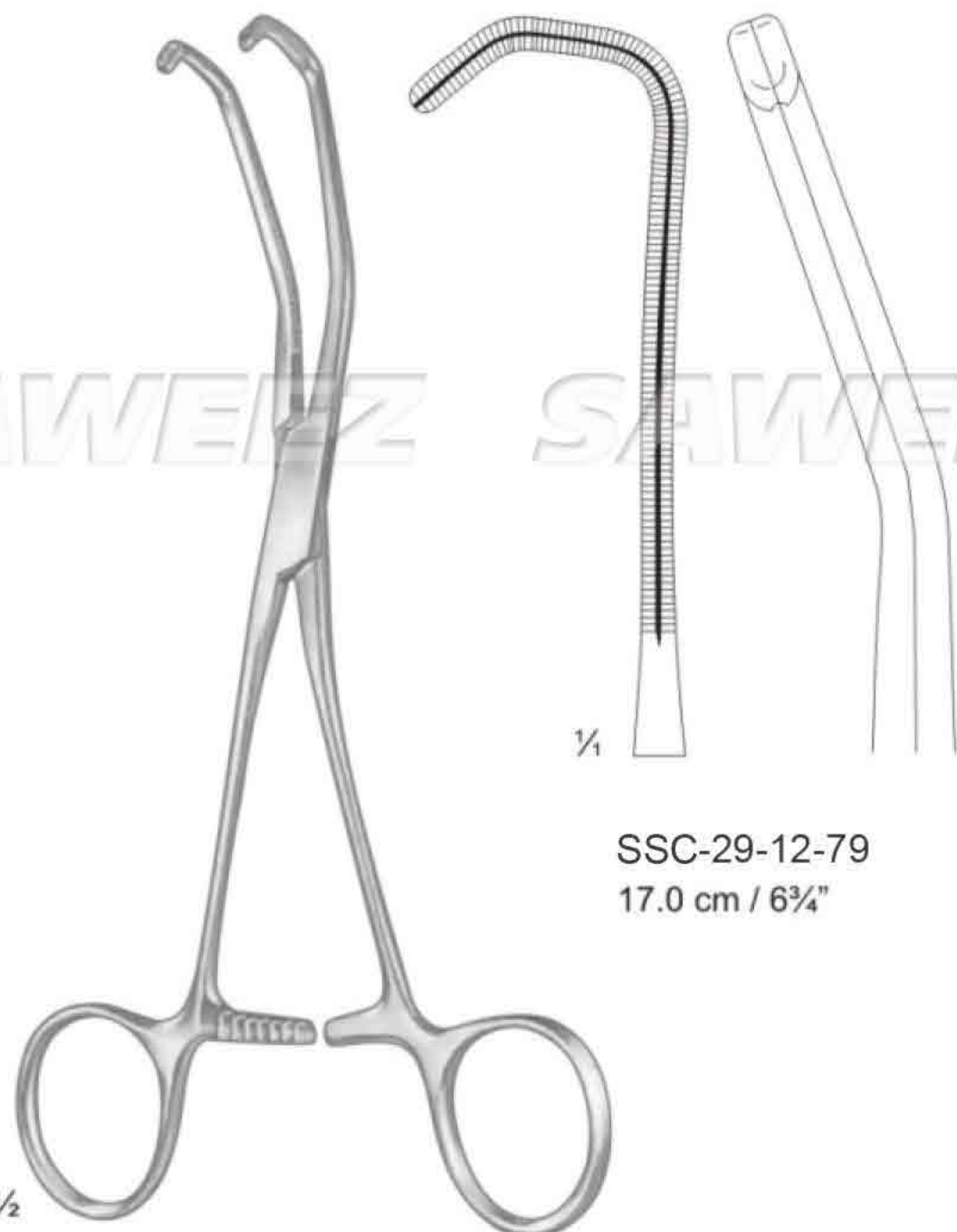


1/4



SAWEEZ SAWEEZ SAWEEZ SAWEEZ

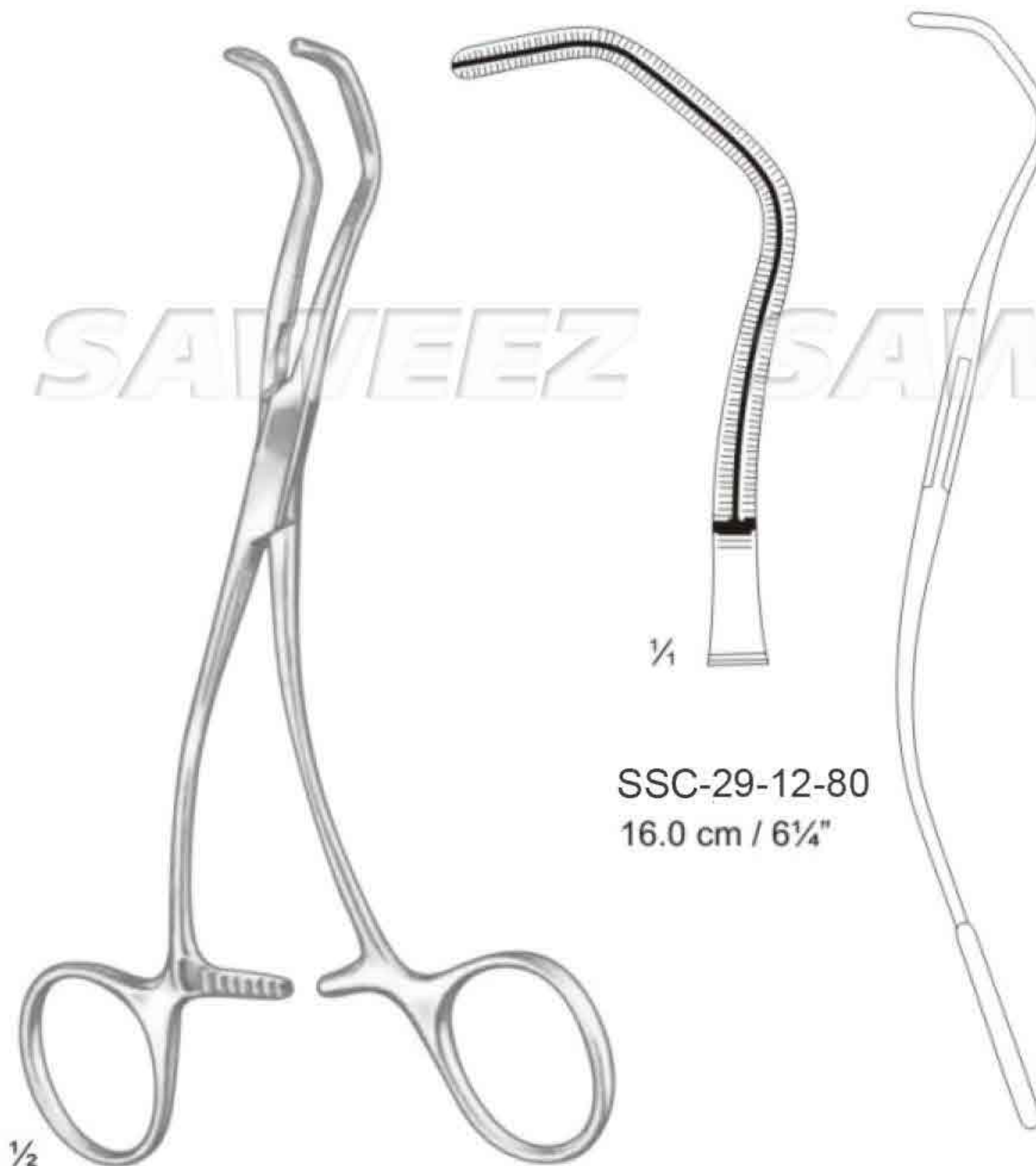




SSC-29-12-79
17.0 cm / 6 3/4"

1/2

Cooley



SSC-29-12-80
16.0 cm / 6 1/4"

1/2

Cooley



SSC-29-12-81
15.0 cm / 6"

1/2

Cooley



SSC-29-12-82
15.5 cm / 6"

1/2

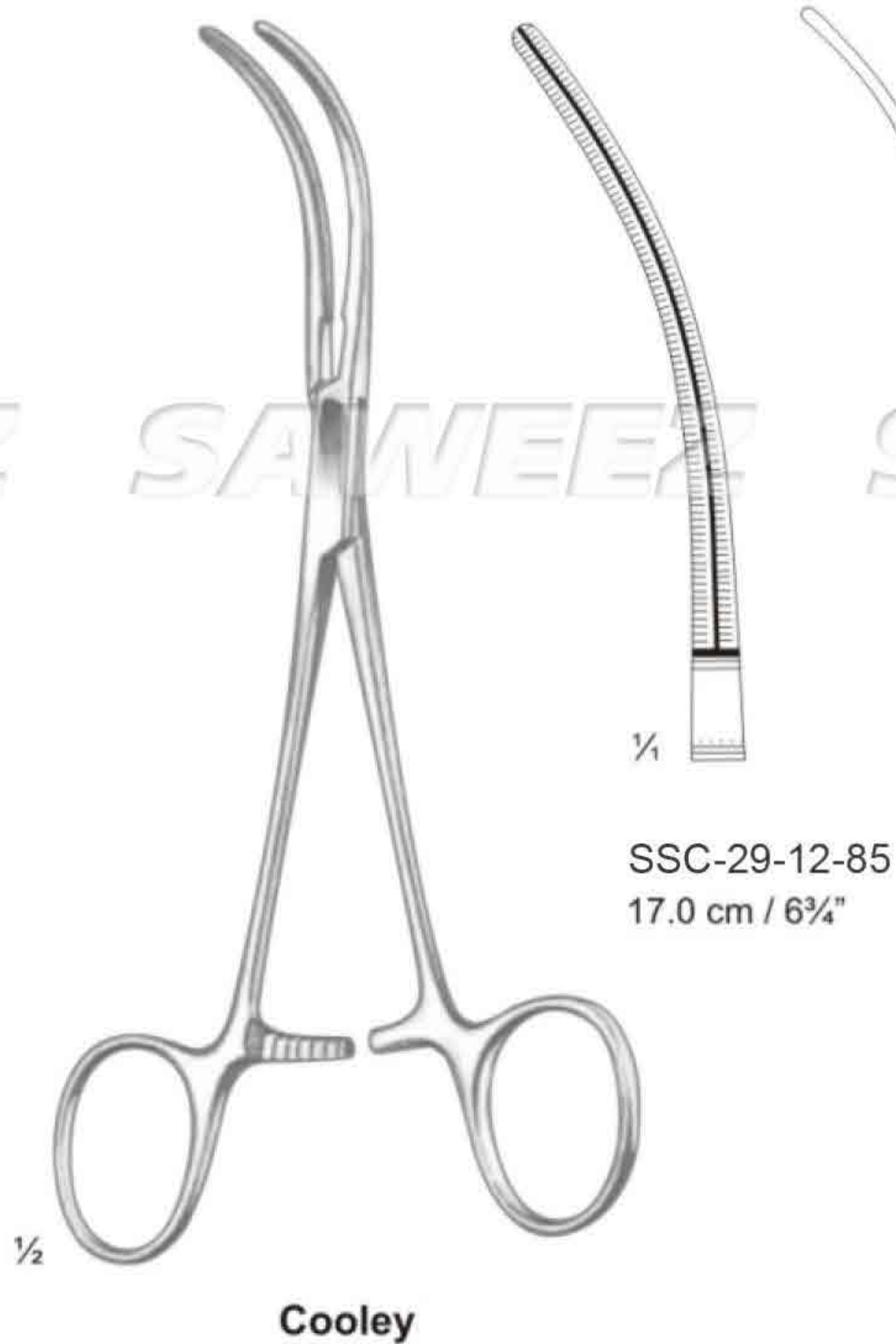
Cooley



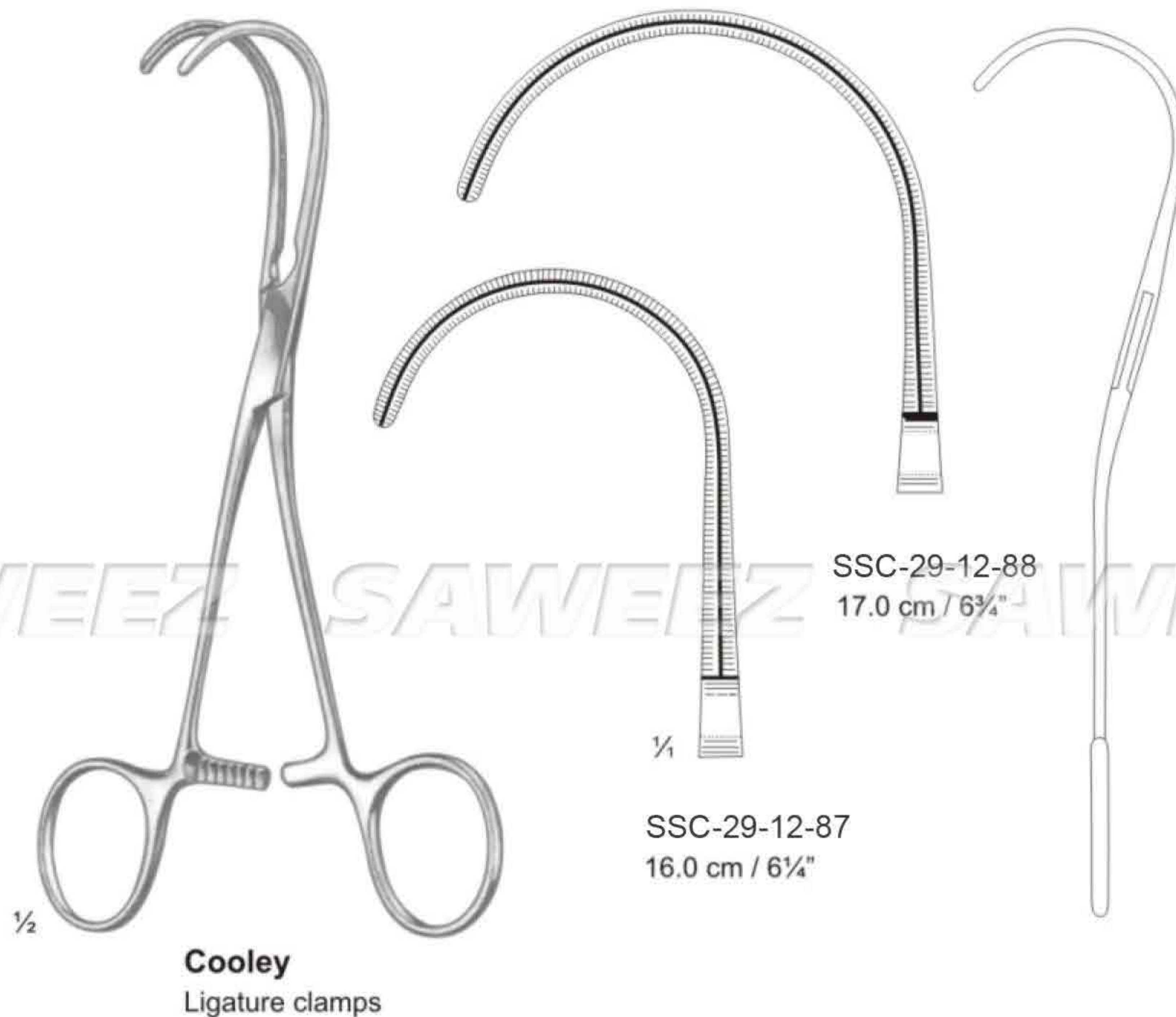
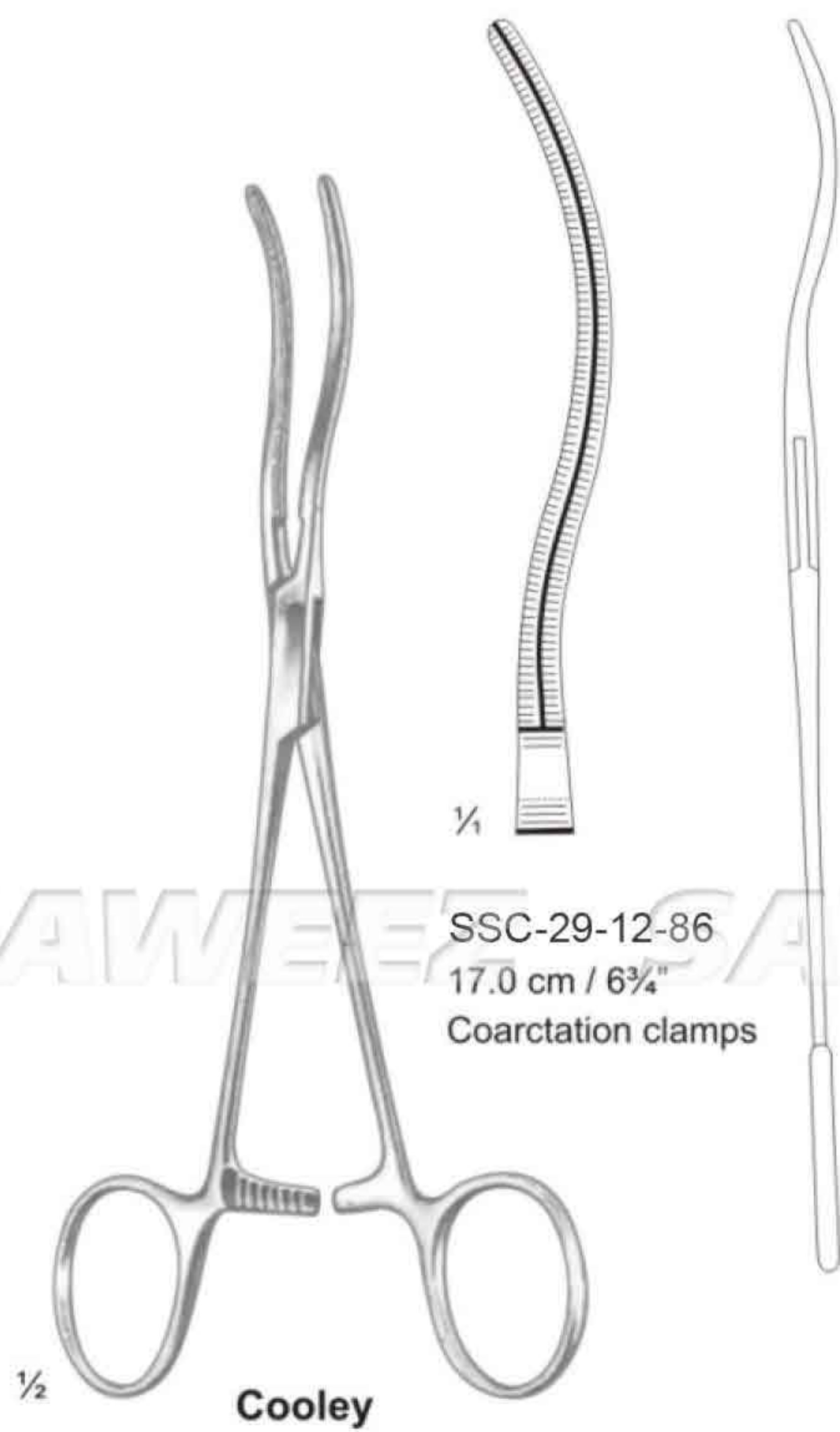
SSC-29-12-83
17.0 cm / 6 3/4"

1/2

Cooley



SAWEEZ SAWEEZ SAWEEZ SAWEEZ



SSC-29-12-88
17.0 cm / 6 3/4"



SAWEEZ SAWEEZ SAWEEZ SAWEEZ

SAWEEZ SAWEEZ SAWEEZ SAWEEZ



Olivecrona

- SSC-29-12-89- 30.0 cm / 12"
- SSC-29-12-90- 40.0 cm / 16"
- SSC-29-12-91- 50.0 cm / 20"
- SSC-29-12-92- 60.0 cm / 24"
- SSC-29-12-93- 70.0 cm / 28"



1/2

SSC-29-12-94



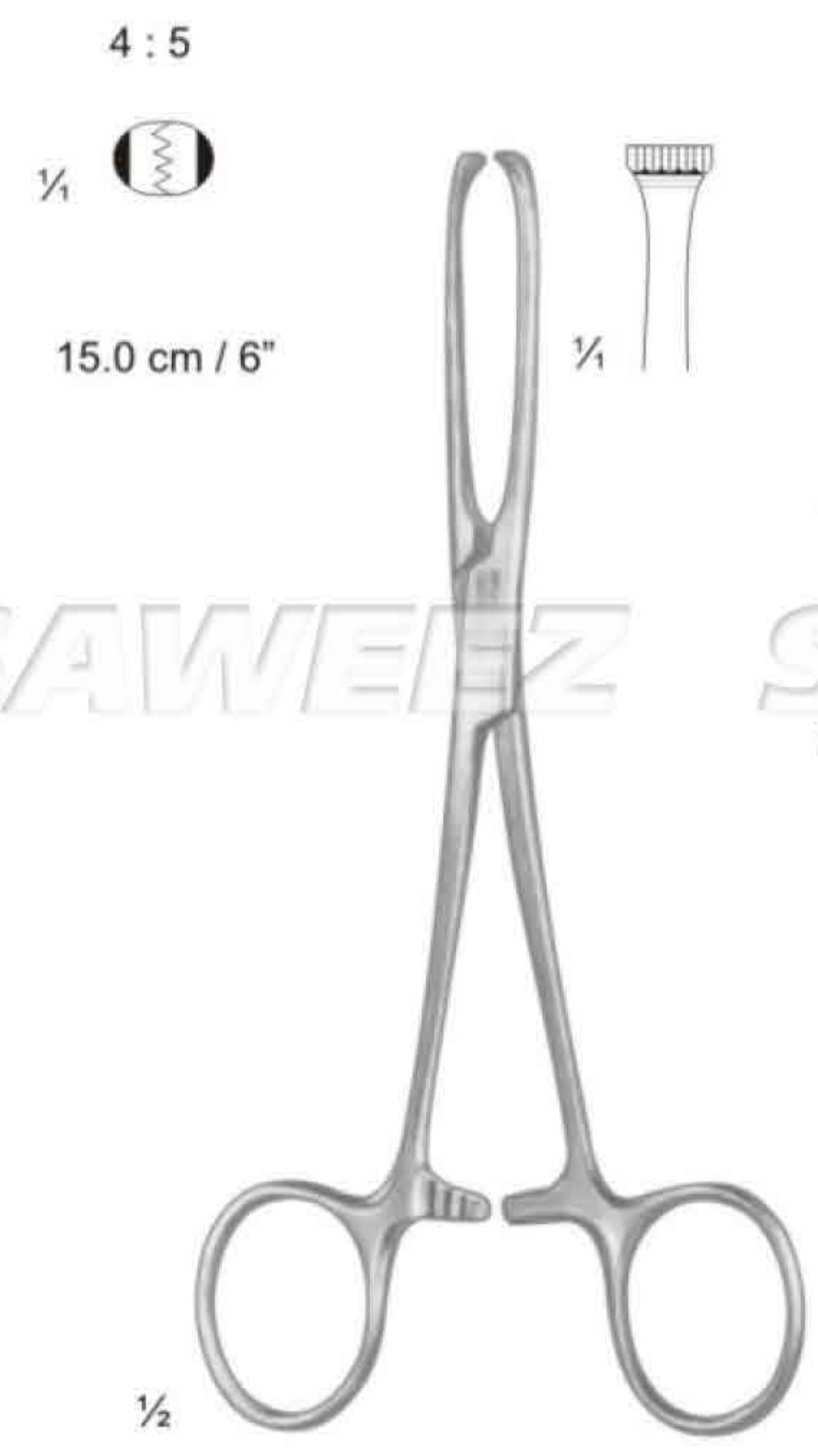
Martel

SSC-29-12-95
33.0 cm / 13"

SAWEEZ SAWEEZ SAWEEZ SAWEEZ



Allis-Baby
SSC-31-11-11
12.0 cm / 4¾"
4 x 5 teeth



Allis Tissue



Allis-Atrauma



SSC-31-11-12
16.0 cm / 6¼"



SSC-31-11-13
20.0 cm / 8"



SSC-31-11-14
25.0 cm / 10"



SSC-31-11-15
30.0 cm / 12"



Allis-Adair
SSC-31-11-16
15.0 cm / 6"
10 x 11 teeth

Boys-Allis
SSC-31-11-17
15.0 cm / 6"

Lockwood-Allis
SSC-31-11-18 - 16.0 cm / 6¼"
SSC-31-11-19 - 20.0 cm / 8"

Judd-Allis
SSC-31-11-20 - 15.0 cm / 6"
SSC-31-11-21 - 19.0 cm / 7½"



Thomas-Allis
SSC-31-11-22
20.0 cm / 8"

Allis
SSC-31-11-23
20.0 cm / 8"

Lockwood
SSC-31-11-24
20.0 cm / 8"

Williams
SSC-31-11-25
16.0 cm / 6¼"

SSC-31-11-26



SSC-31-11-26
16.0 cm / 6 1/4"



SSC-31-11-27
18.0 cm / 7"



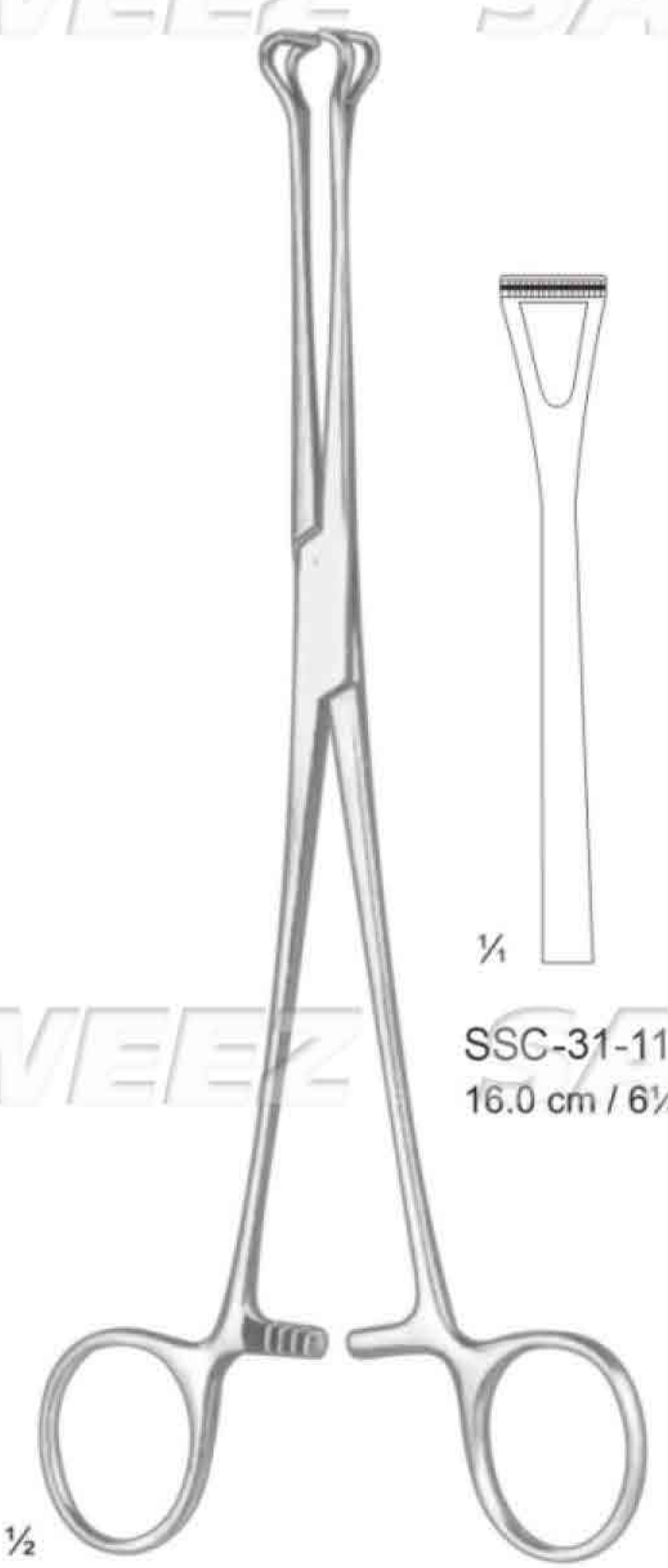
SSC-31-11-28
20.0 cm / 8"



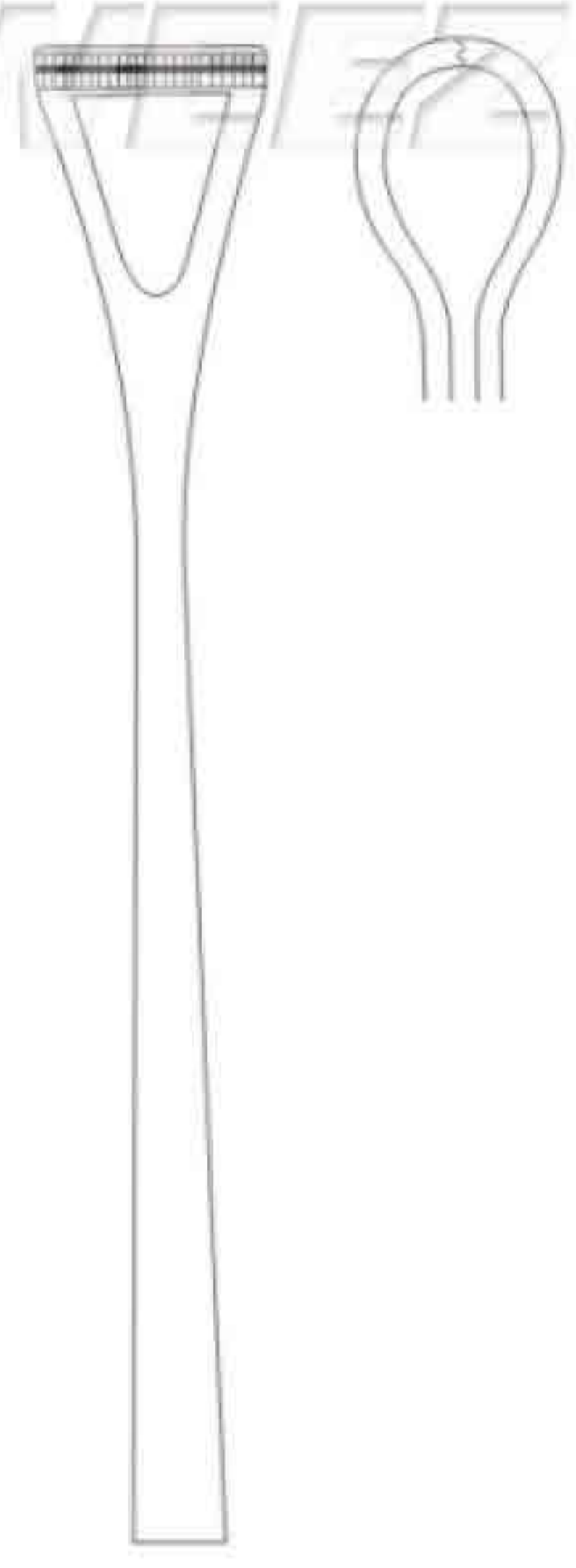
SSC-31-11-29
24.0 cm / 9 1/2"



SAWEEZ SAWEEZ



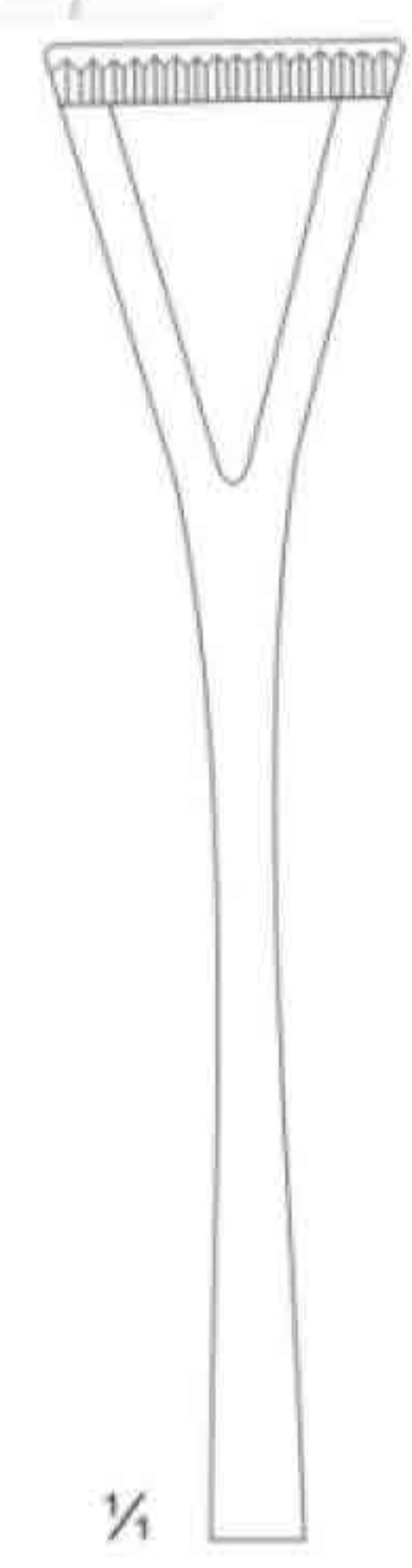
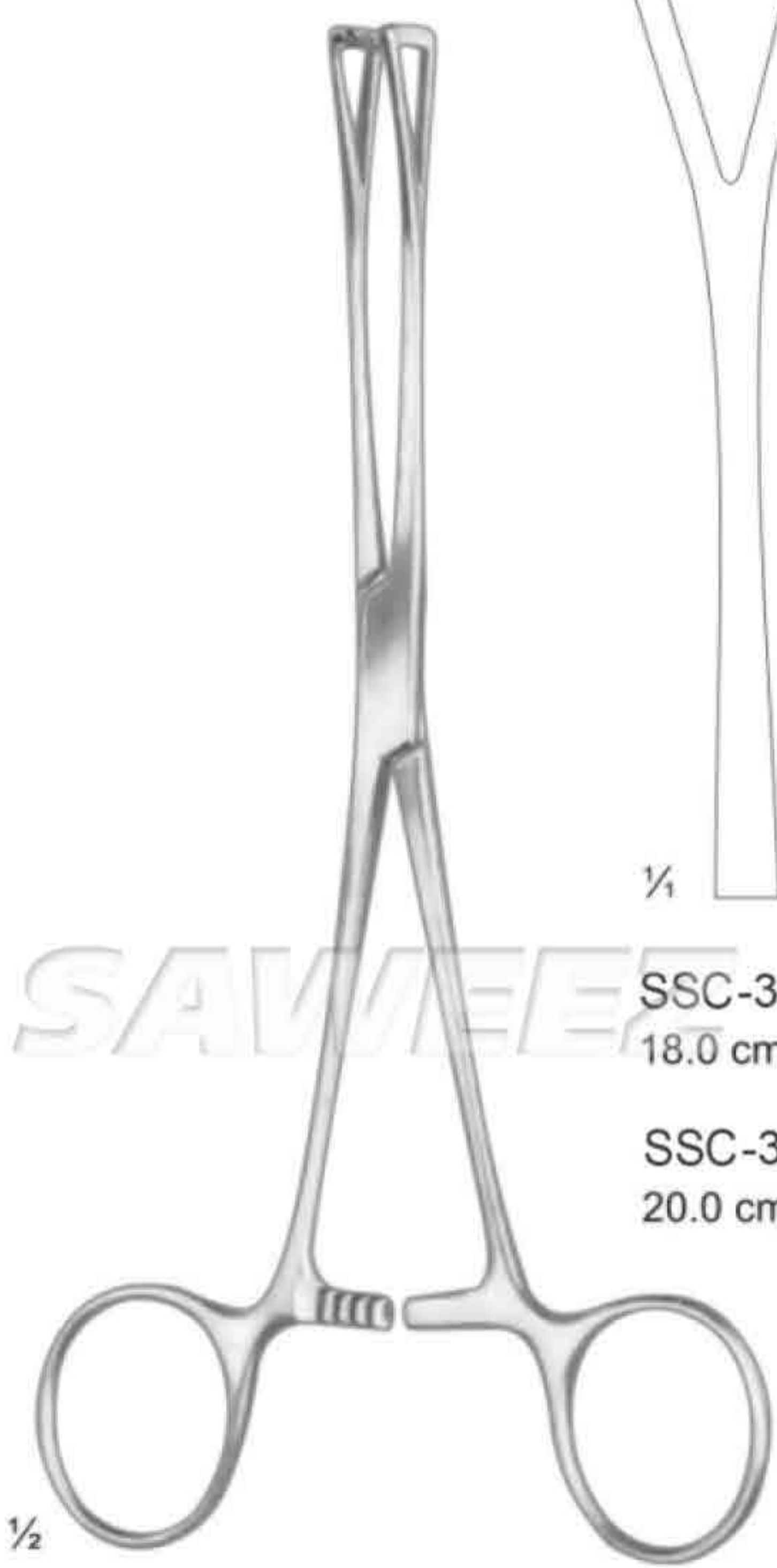
SSC-31-11-30
16.0 cm / 6 1/4"



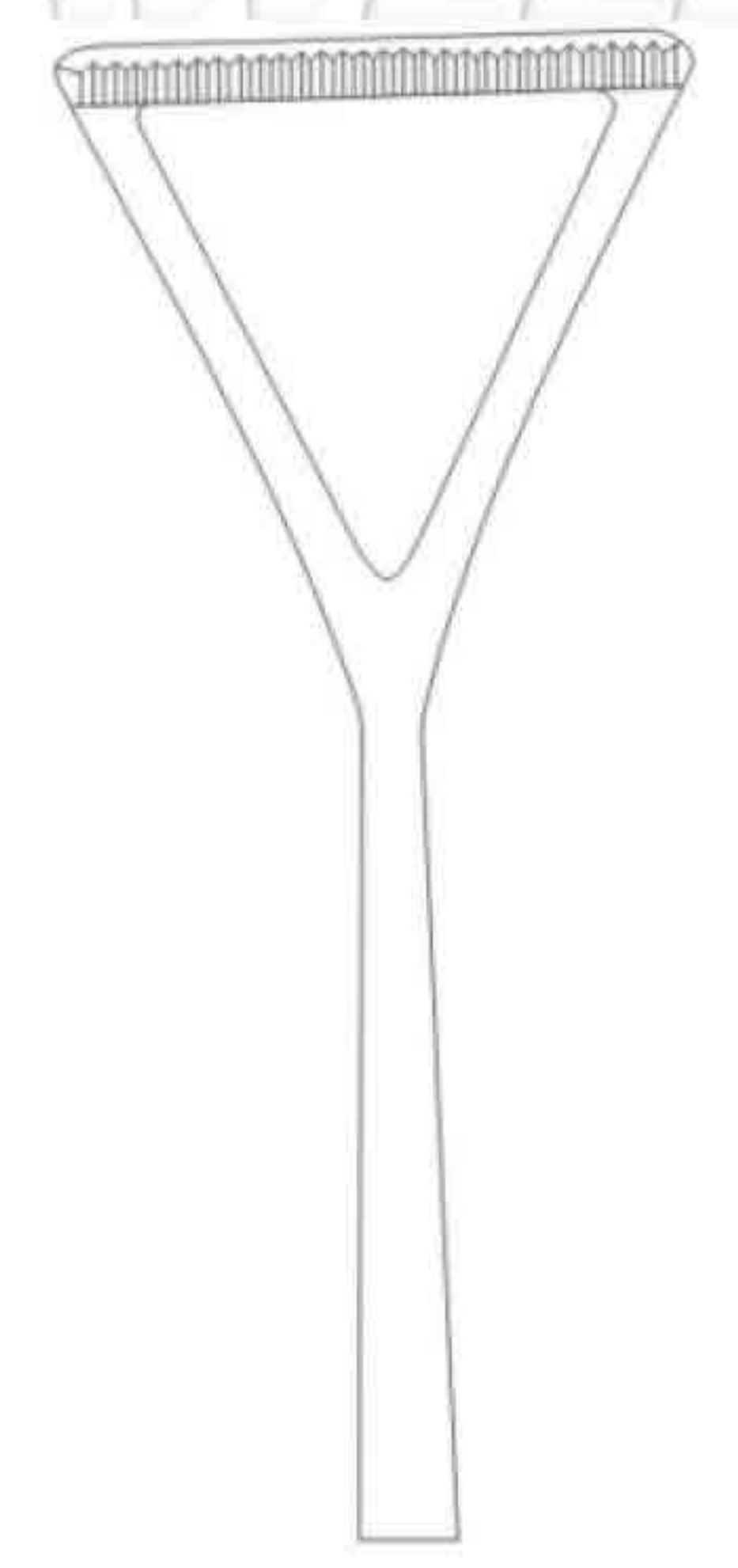
SSC-31-11-31
20.0 cm / 8"

SAWEEZ SAWEEZ

SAWEEZ SAWEEZ



SSC-31-11-32
18.0 cm / 7"

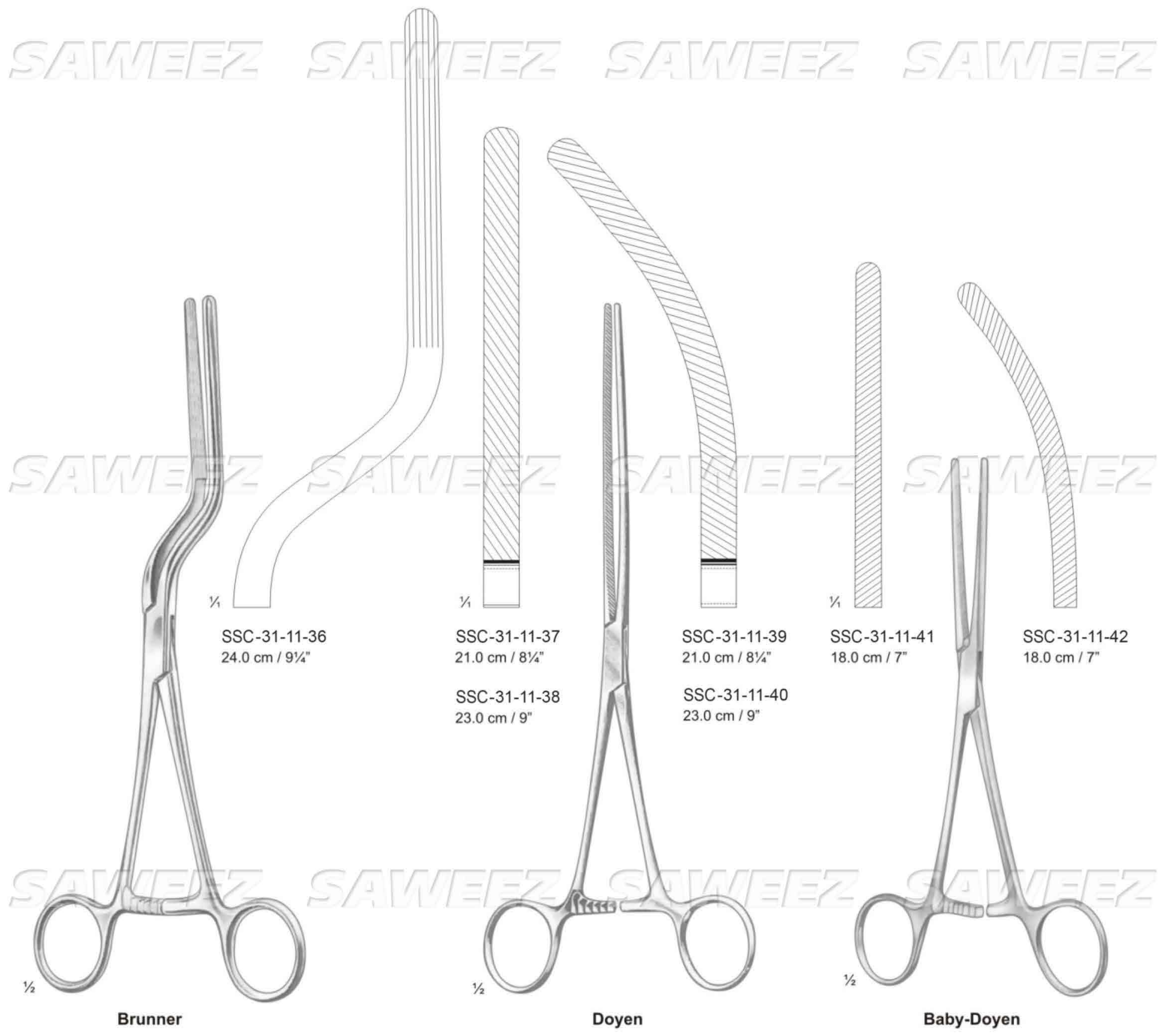


SSC-31-11-34
20.0 cm / 8"

SSC-31-11-33
20.0 cm / 8"

SSC-31-11-35
23.0 cm / 9"

SAWEEZ SAWEEZ





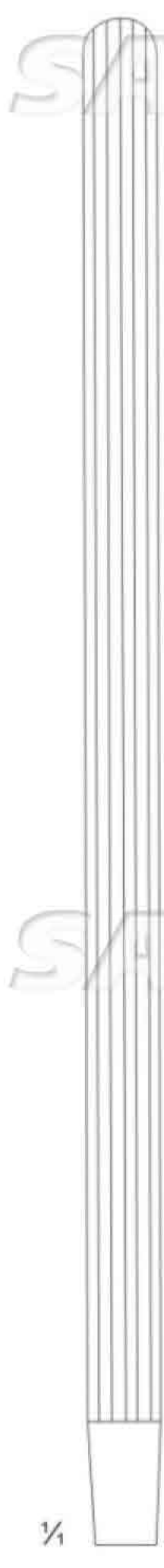
SAWEEZ SAWEEZ SAWEEZ SAWEEZ



SSC-31-11-43
21.0 cm / 8 1/4"



SSC-31-11-45
21.0 cm / 8 1/4"

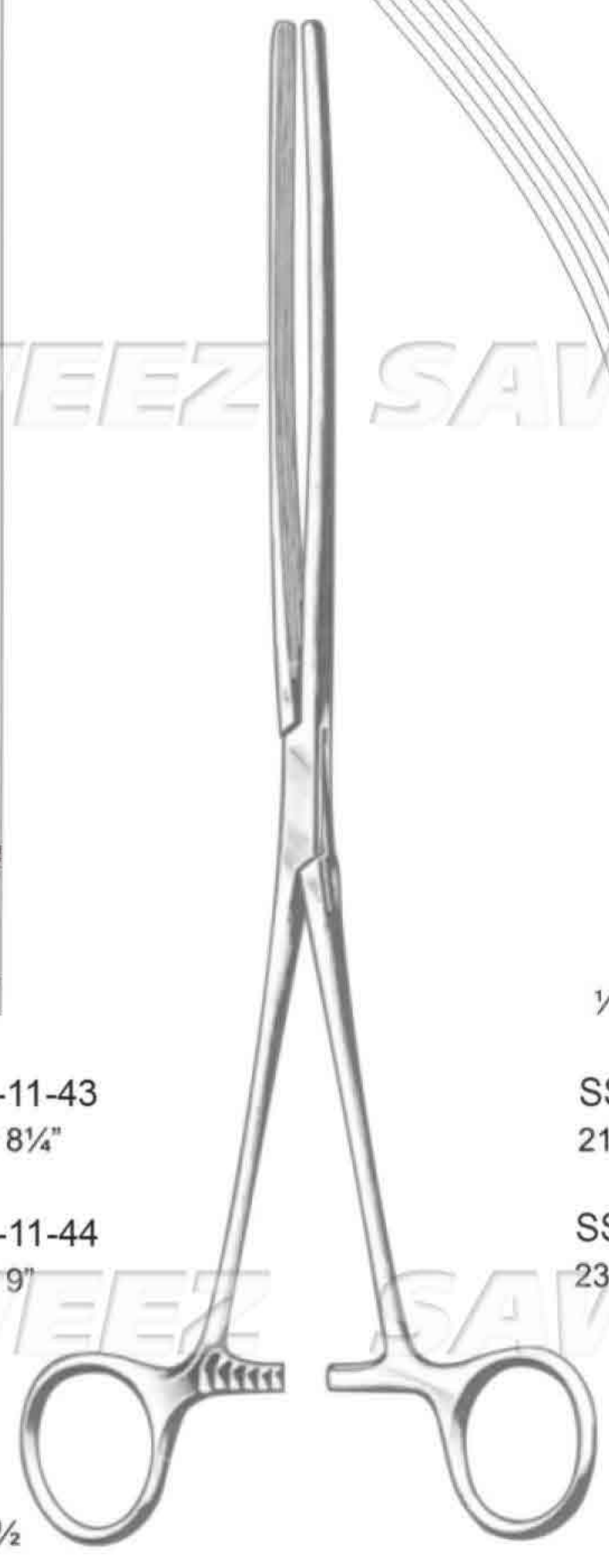


SSC-31-11-47



SSC-31-11-48

SSC-31-11-44
23.0 cm / 9"



Mayo-Robson

SSC-31-11-46
23.0 cm / 9"



Mayo-Robson
25.0 cm / 10"

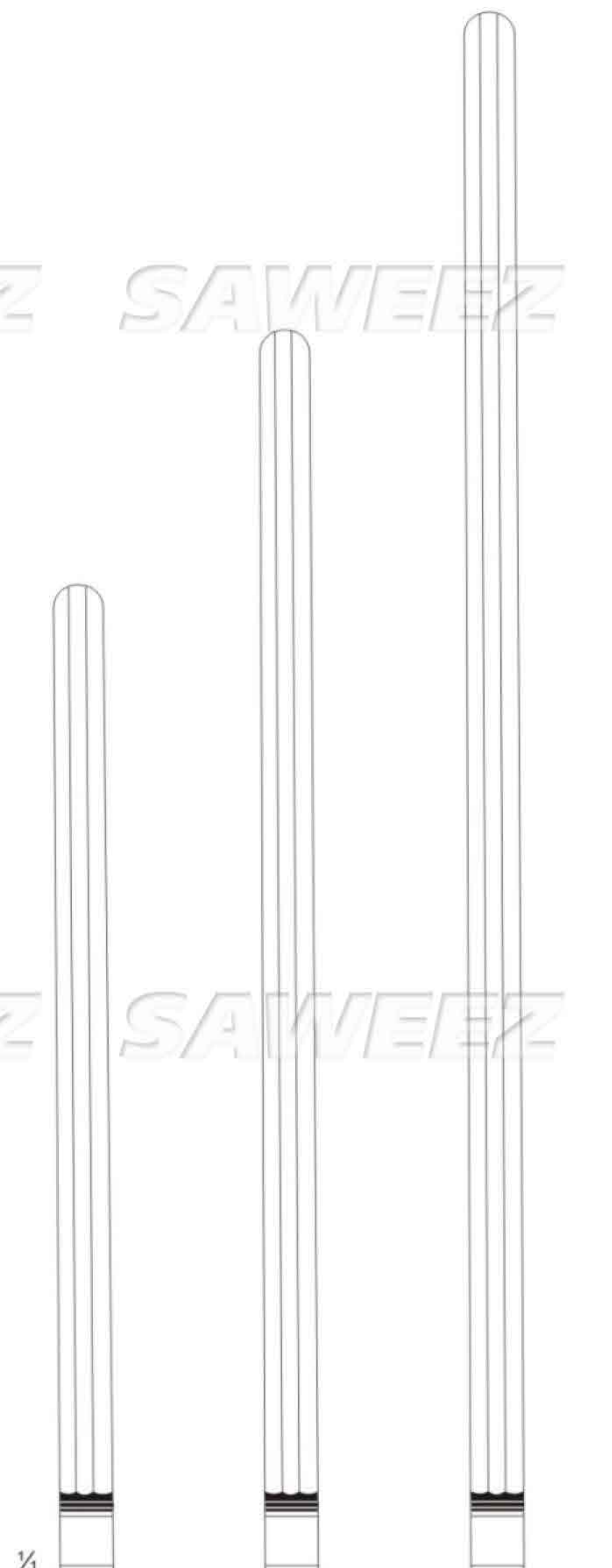
SAWEEZ SAWEEZ SAWEEZ SAWEEZ



SAWEEZ SAWEEZ SAWEEZ SAWEEZ

SAWEEZ SAWEEZ SAWEEZ SAWEEZ

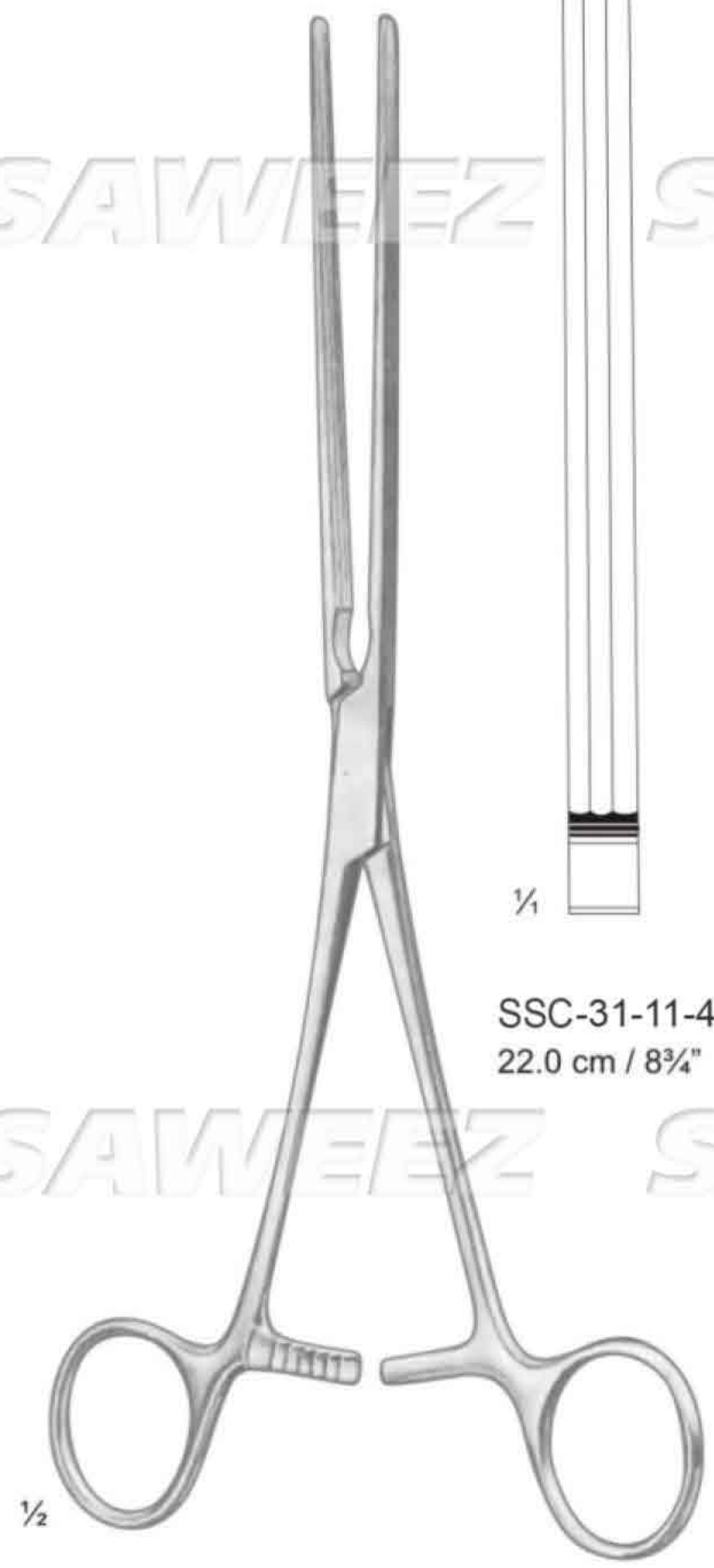
SAWEEZ SAWEEZ SAWEEZ SAWEEZ



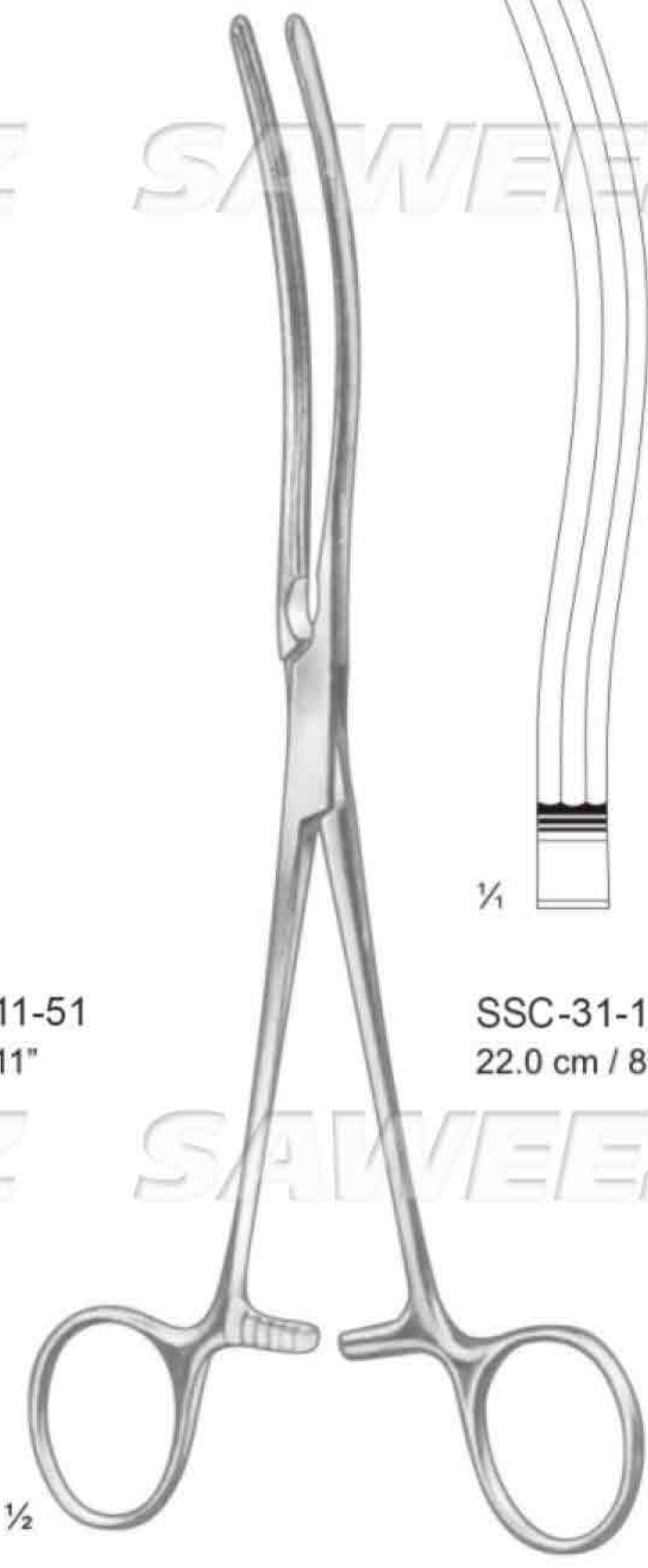
SSC-31-11-49 22.0 cm / 8 3/4"
SSC-31-11-50 25.0 cm / 10"
SSC-31-11-51 28.0 cm / 11"



SSC-31-11-52 22.0 cm / 8 3/4"
SSC-31-11-53 25.0 cm / 10"
SSC-31-11-54 28.0 cm / 11"



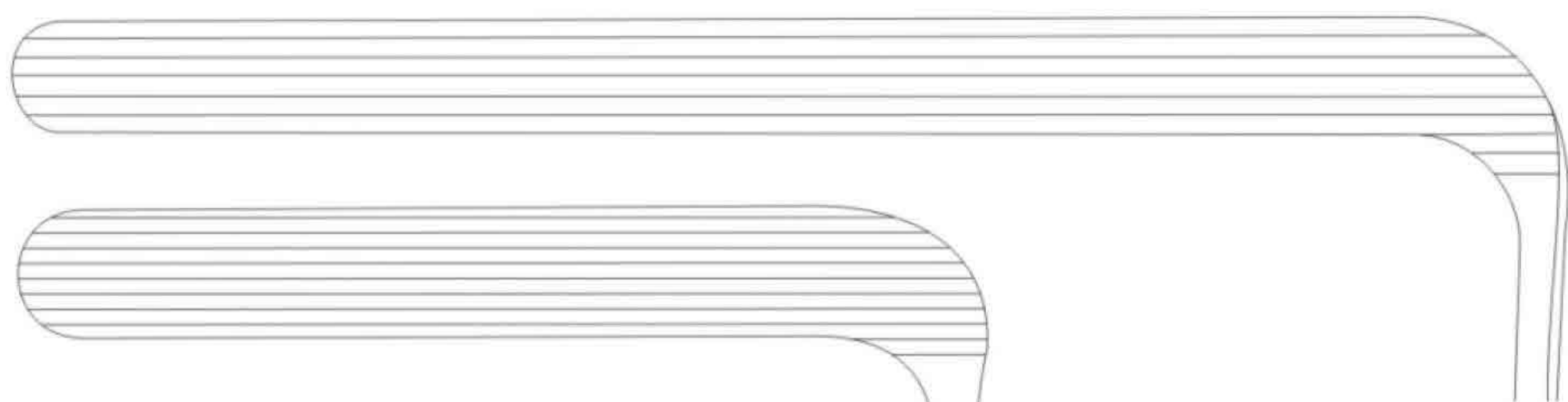
Kocher



Kocher



SAWEEZ SAWEEZ SAWEEZ SAWEEZ



SSC-31-11-56

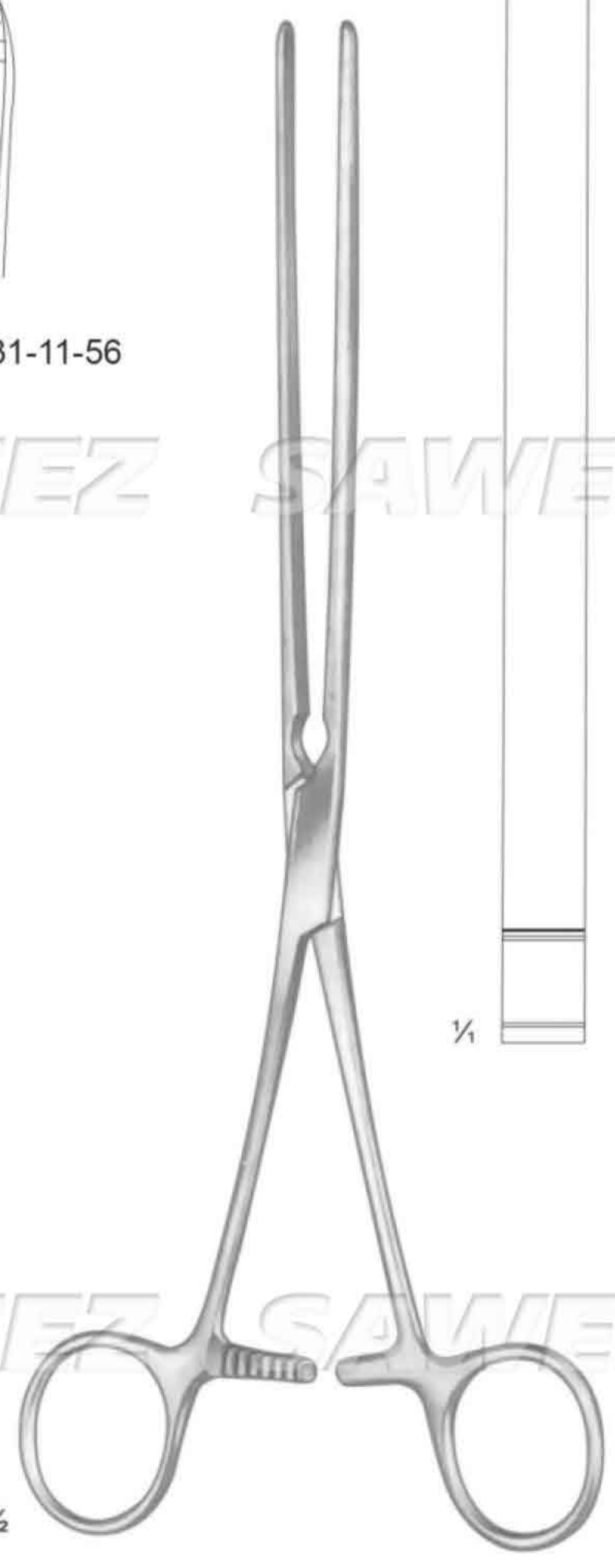
SAWEEZ SAWEEZ SAWEEZ SAWEEZ



SSC-31-11-55

1/2

Mikulicz
19.0 cm / 7 1/2"



1/4

1/2

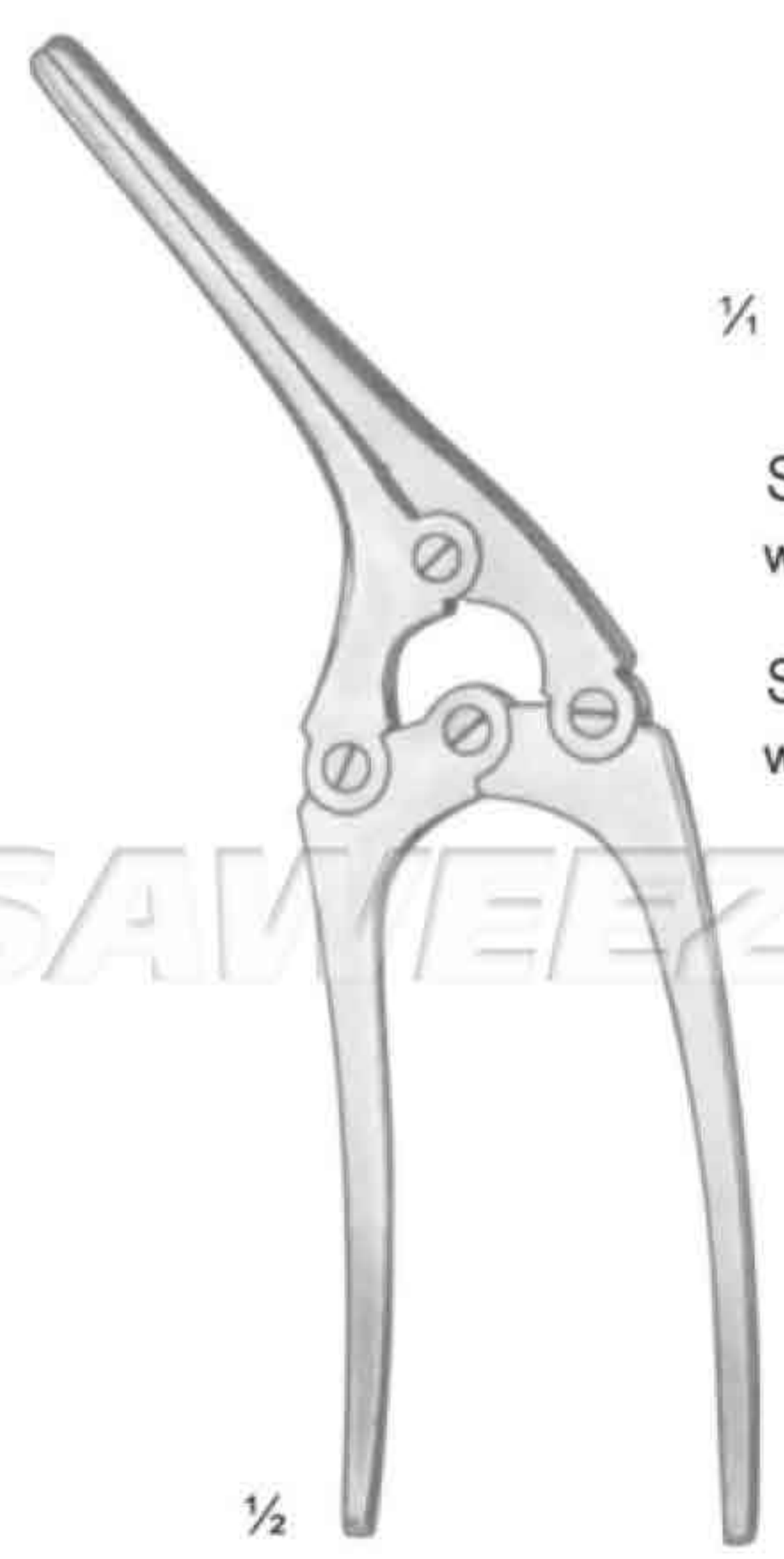
Scudder
SSC-31-11-57
25.0 cm / 10"

SAWEEZ SAWEEZ SAWEEZ SAWEEZ

SAWEEZ SAWEEZ SAWEEZ SAWEEZ

SAWEEZ SAWEEZ SAWEEZ SAWEEZ

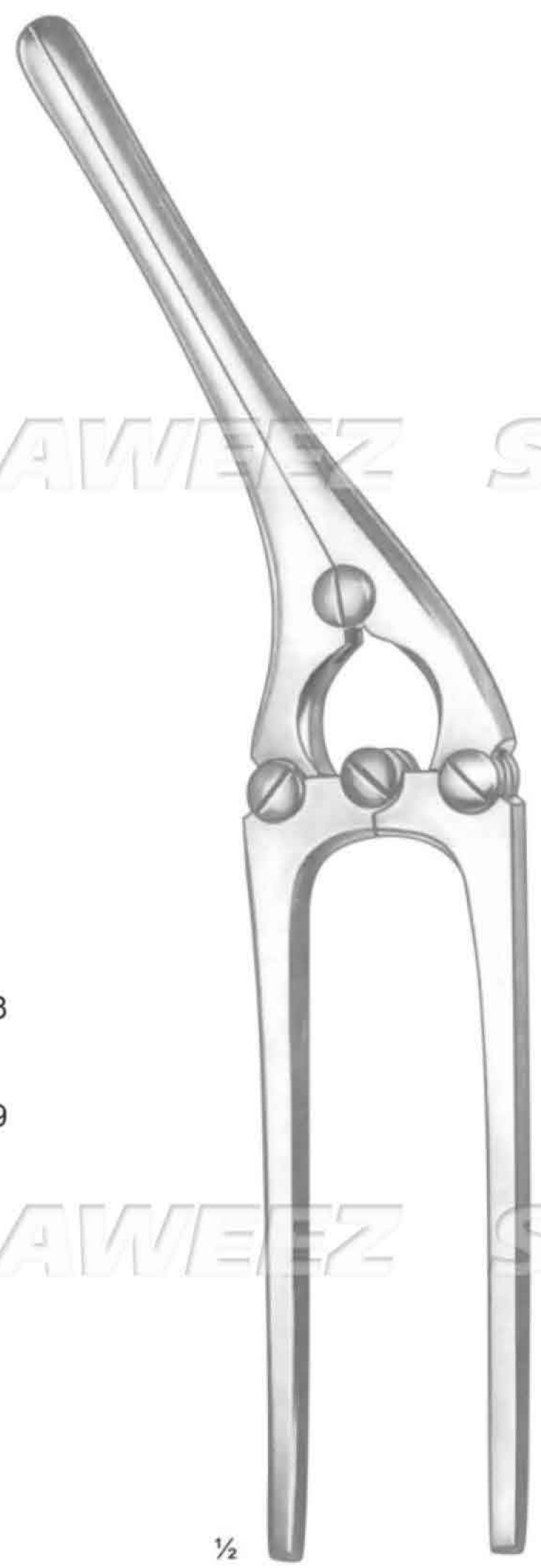
SAWEEZ SAWEEZ SAWEEZ SAWEEZ



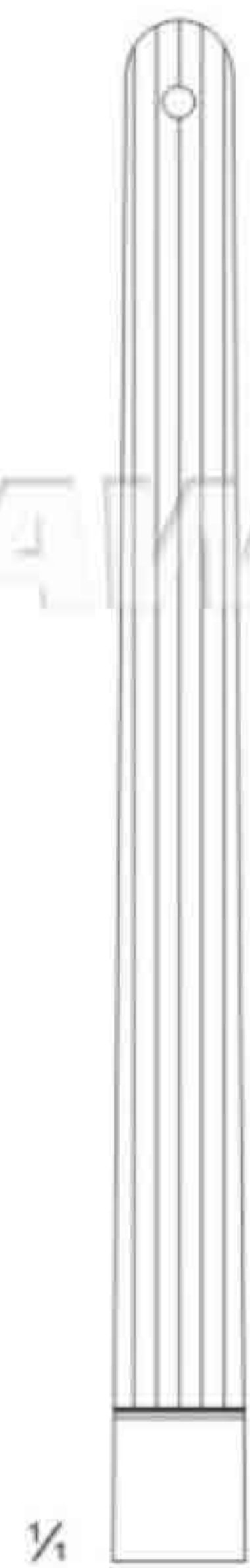
Payr-Baby
15.0 cm / 6"



SSC-31-11-58
without pin
SSC-31-11-59
with pin



Payr



SSC-31-11-60
21.0 cm / 8 1/4"
without pin

SSC-31-11-61
21.0 cm / 8 1/4"
with pin



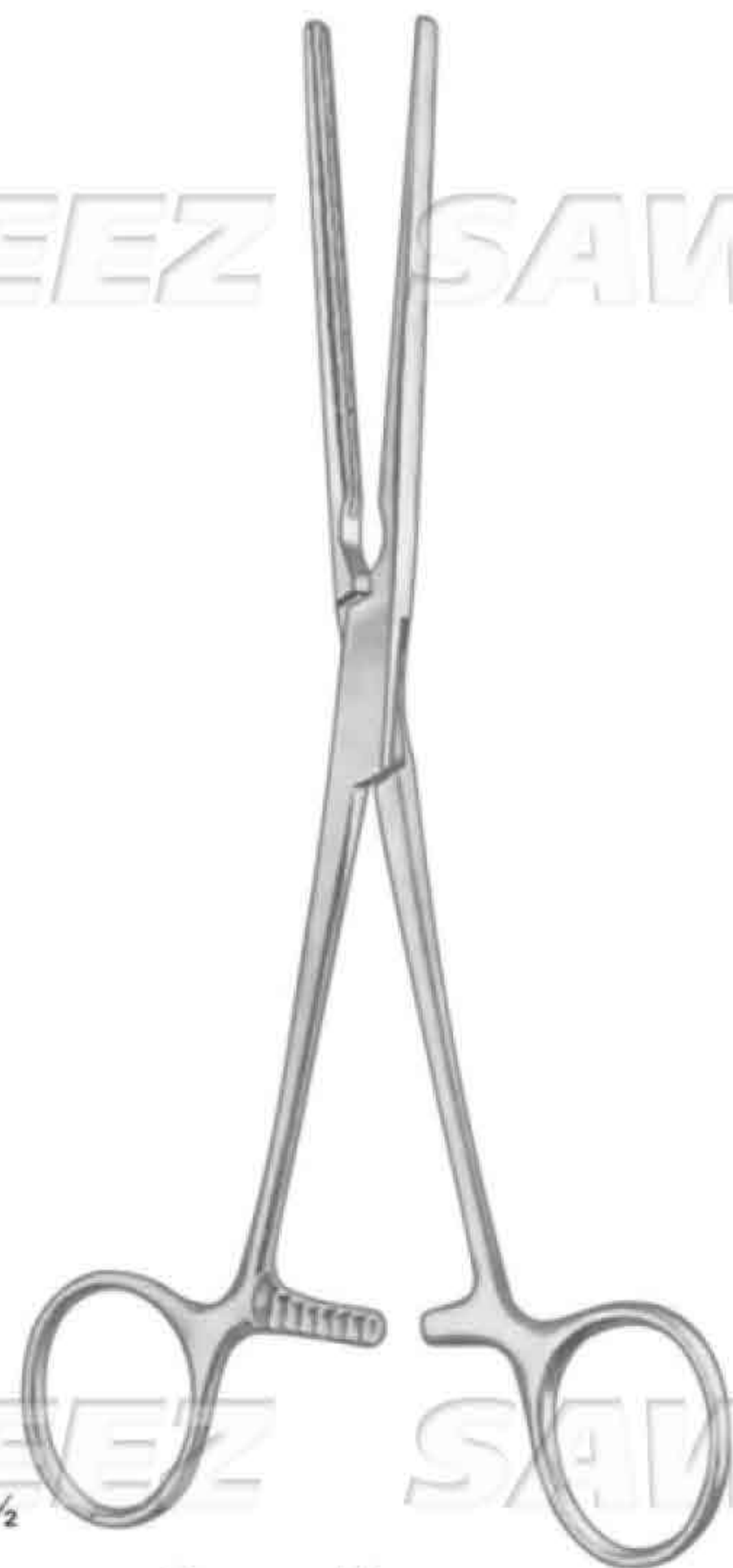
SSC-31-11-62
29.0 cm / 11 1/2"
without pin

SSC-31-11-63
29.0 cm / 11 1/2"
with pin

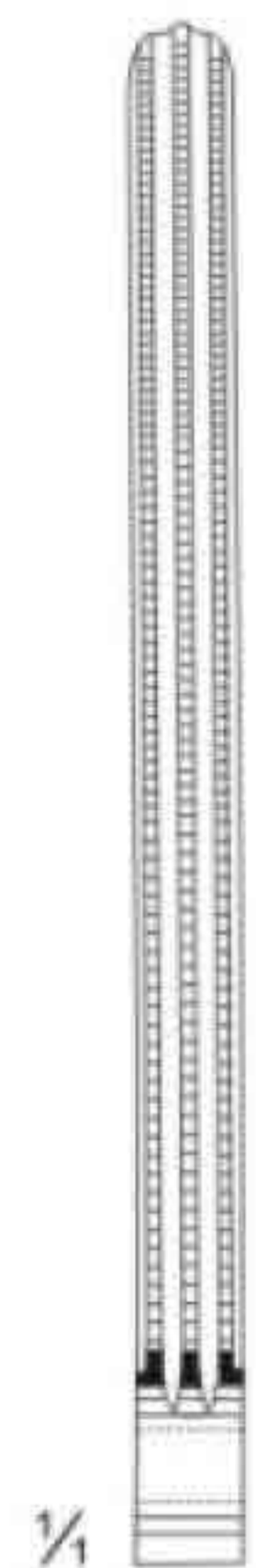


SSC-31-11-64
35.0 cm / 12 3/4"
without pin

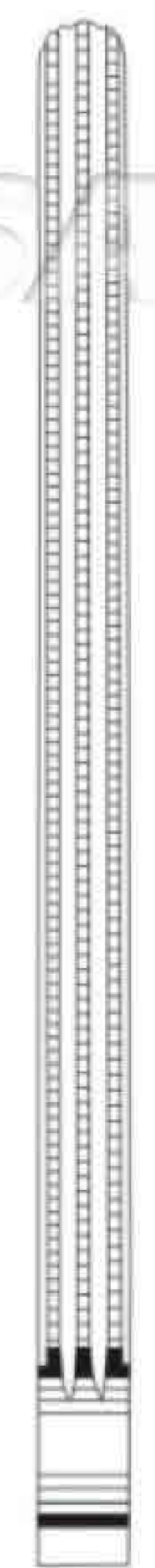
SSC-31-11-65
35.0 cm / 13 3/4"
with pin



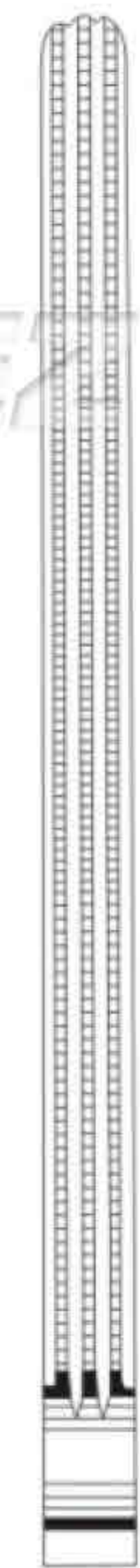
Doyen-Atrauma



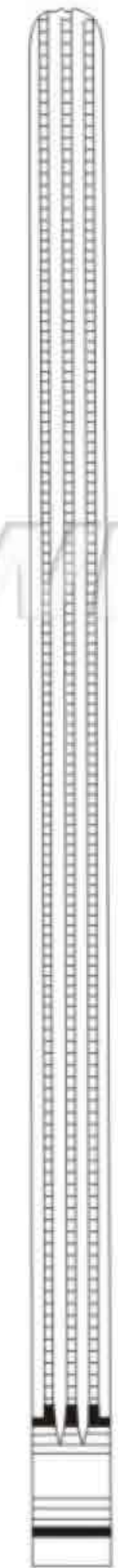
SSC-31-11-66
16.0 cm / 6¼"



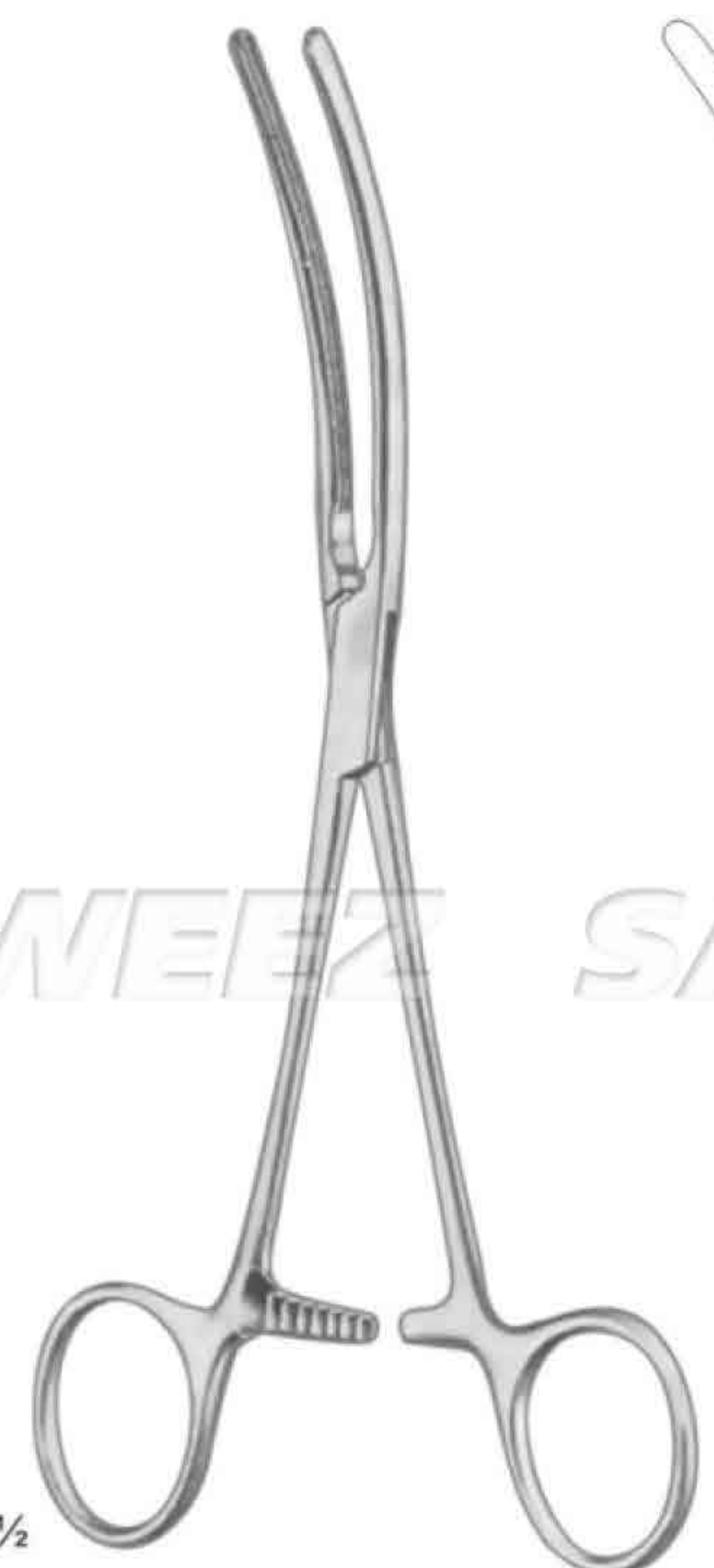
SSC-31-11-67
18.0 cm / 7"



SSC-31-11-68
21.0 cm / 8¼"



SSC-31-11-69
23.0 cm / 9"



Doyen-Atrauma



SSC-31-11-70
16.0 cm / 6¼"



SSC-31-11-71
18.0 cm / 7"



SSC-31-11-72
21.0 cm / 8¼"



SSC-31-11-73
23.0 cm / 9"



1/2
Czerny
 SSC-31-11-74
 22.0 cm / 8 3/4"

1/2
Sims
 SSC-31-11-75
 15.0 cm / 6"

1/2
Sims
 SSC-31-11-76
 15.0 cm / 6"

1/2
Sims
 SSC-31-11-77
 15.0 cm / 6"

with interchangeable fiber optic light carrier



Ives-Fansler
SSC-31-11-78
22 mm ø

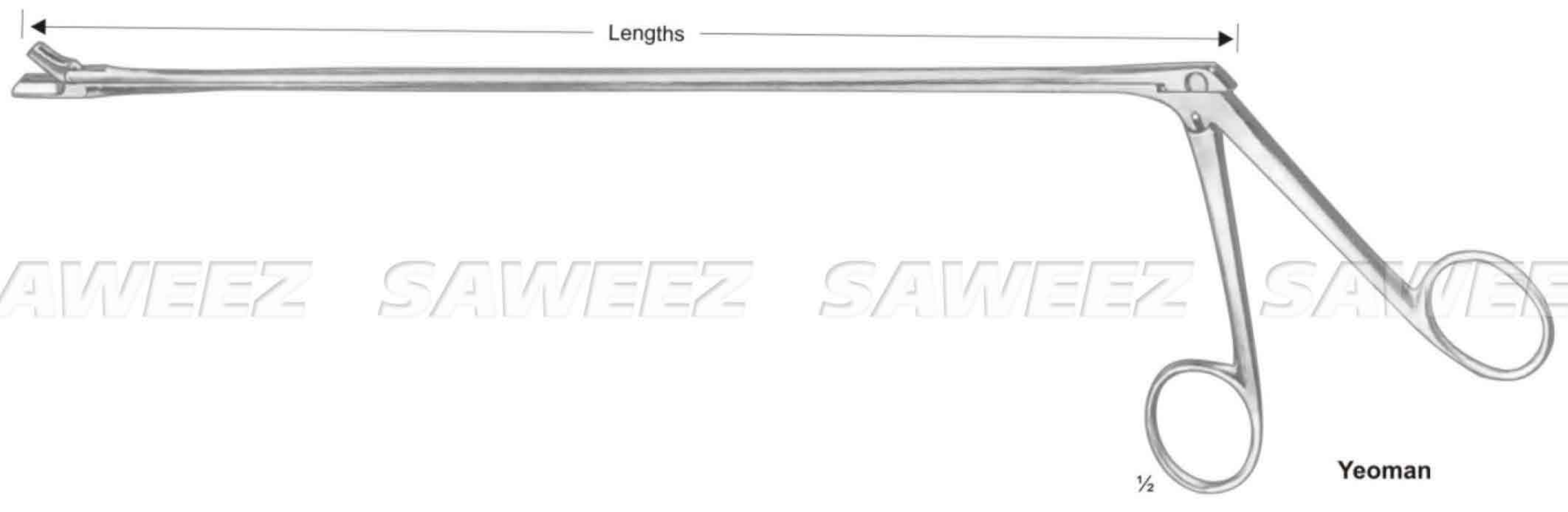
Ives-Fansler
SSC-31-11-79
22 mm ø

Hirschmann
SSC-31-11-80-16 mm ø x 65mm
SSC-31-11-81-19 mm ø x 65mm
SSC-31-11-82-22 mm ø x 65mm

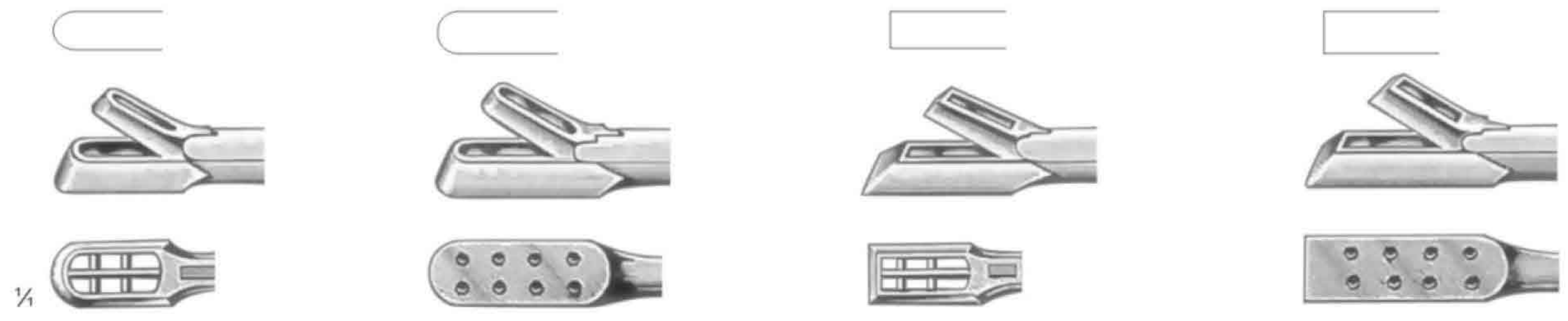
Kelly
SSC-31-11-83 - 21 mm ø x 50mm
SSC-31-11-84 - 27 mm ø x 50mm

Kelly
SSC-31-11-85 - 22 mm ø x 50mm
SSC-31-11-86 - 22 mm ø x 100mm
SSC-31-11-87 - 22 mm ø x 140mm

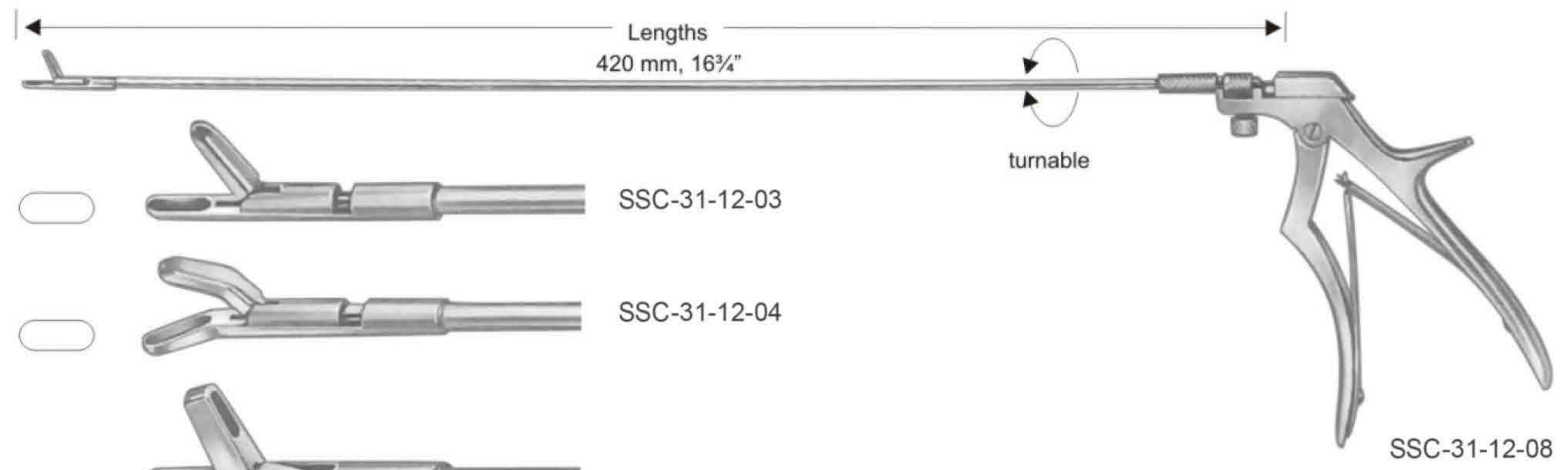
Newman
SSC-31-11-88- 16 mm ø x 63mm
SSC-31-11-89- 19 mm ø x 63mm
SSC-31-11-90- 23 mm ø x 63mm



SAWEEZ SAWEEZ SAWEEZ SAWEEZ



- | | | | |
|--|--|--|--|
| SSC-31-11-91- 28.0 cm / 11" | SSC-31-11-94- 28.0 cm / 11" | SSC-31-11-97- 28.0 cm / 11" | SSC-31-12-00- 28.0 cm / 11" |
| SSC-31-11-92- 35.0 cm / 13 $\frac{3}{4}$ " | SSC-31-11-95- 35.0 cm / 13 $\frac{3}{4}$ " | SSC-31-11-98- 35.0 cm / 13 $\frac{3}{4}$ " | SSC-31-12-01- 35.0 cm / 13 $\frac{3}{4}$ " |
| SSC-31-11-93- 42.0 cm / 16 $\frac{1}{2}$ " | SSC-31-11-96- 42.0 cm / 16 $\frac{1}{2}$ " | SSC-31-11-99- 42.0 cm / 16 $\frac{1}{2}$ " | SSC-31-12-02- 42.0 cm / 16 $\frac{1}{2}$ " |



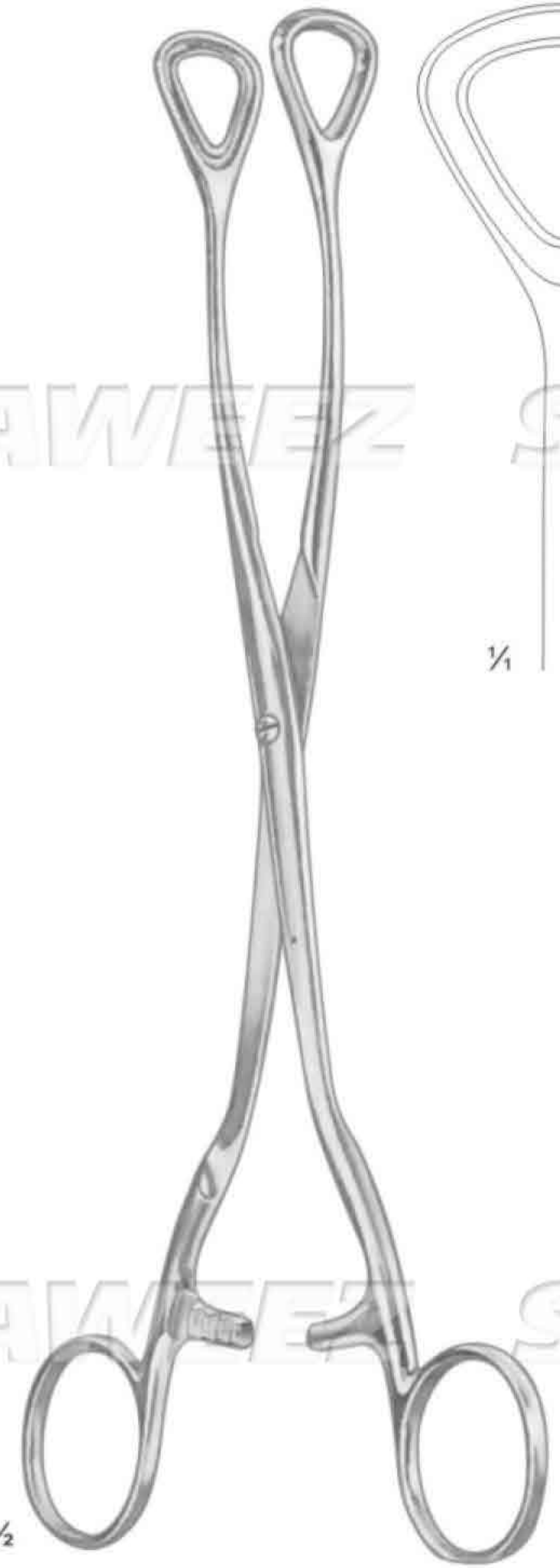
SAWEEZ SAWEEZ SAWEEZ SAWEEZ

- | | | |
|---------------|--|--------------|
| | | SSC-31-12-03 |
| | | SSC-31-12-04 |
| | | SSC-31-12-05 |
| | | SSC-31-12-06 |
| $\frac{1}{4}$ | | SSC-31-12-07 |

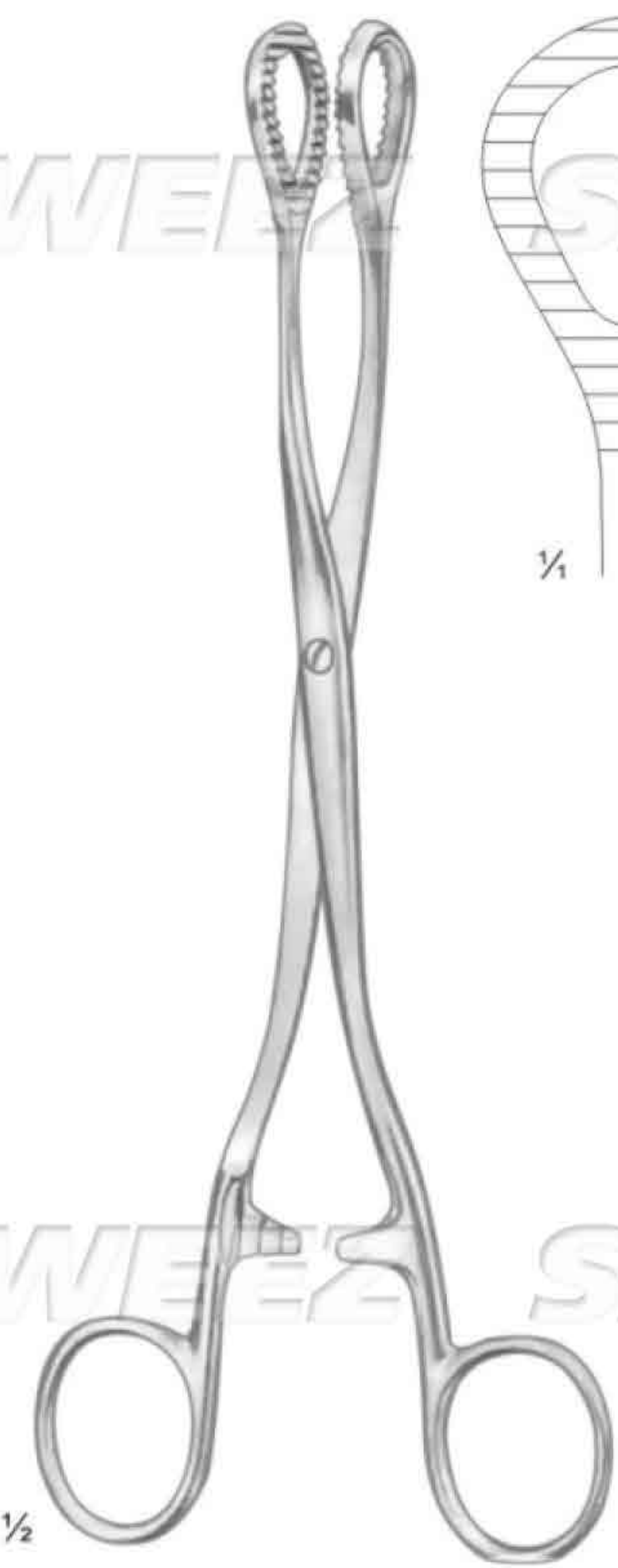
Handle only



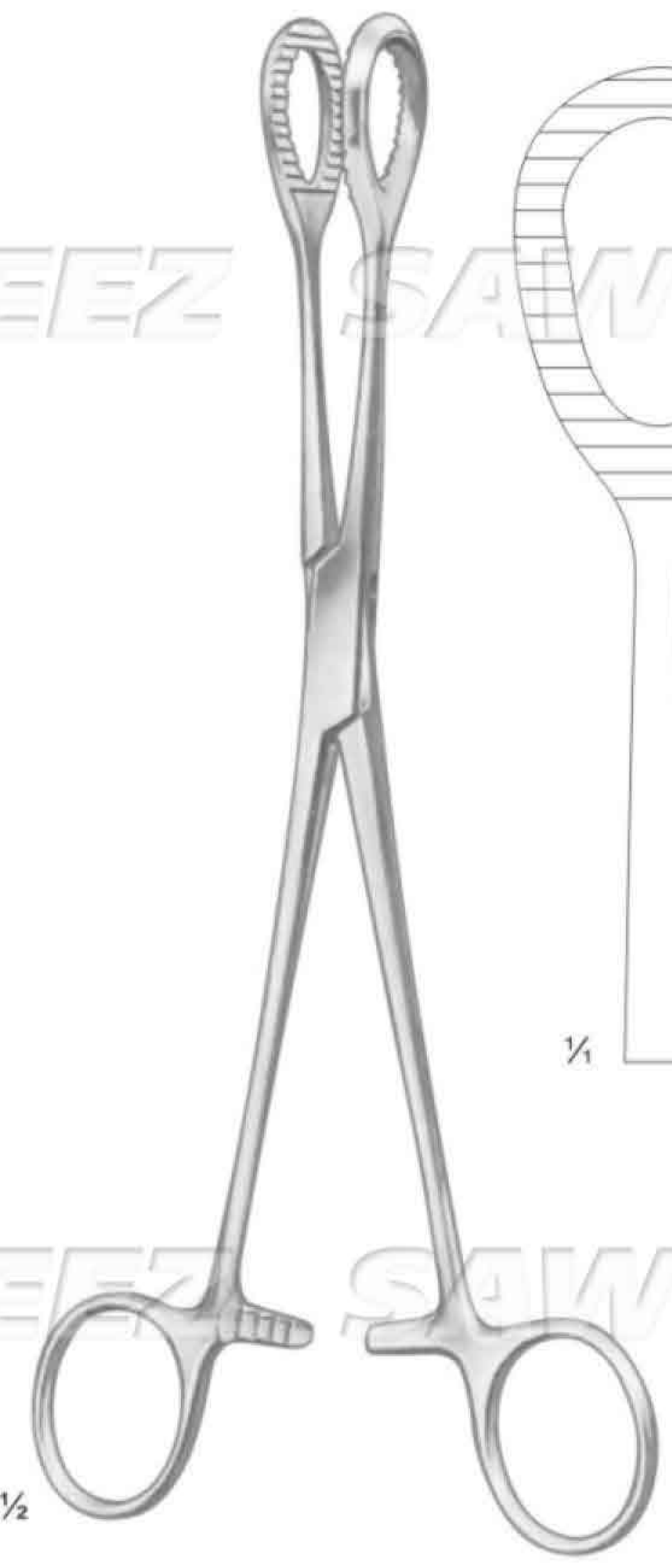
SSC-31-12-09
15 mm



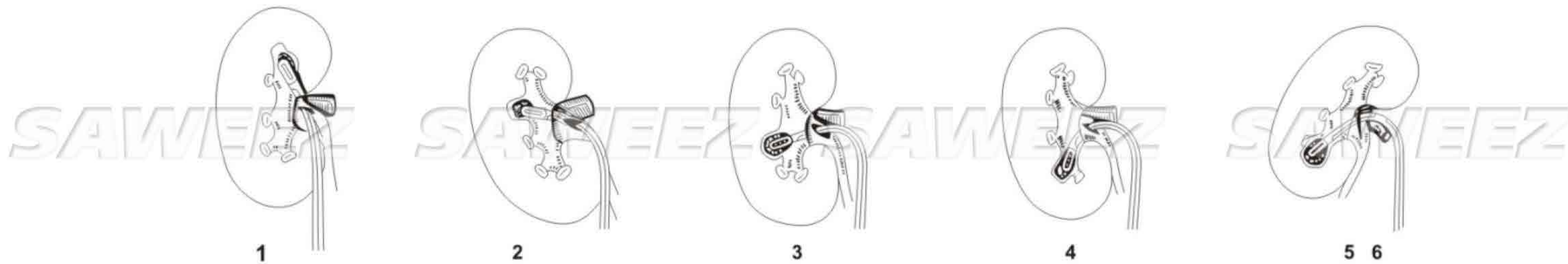
Luer
SSC-31-12-10
24.5 cm / 9 3/4"



Heywood-Smith
SSC-31-12-11
20.0 cm / 8"



Heywood-Smith
SSC-31-12-12
21.0 cm / 8 1/4"

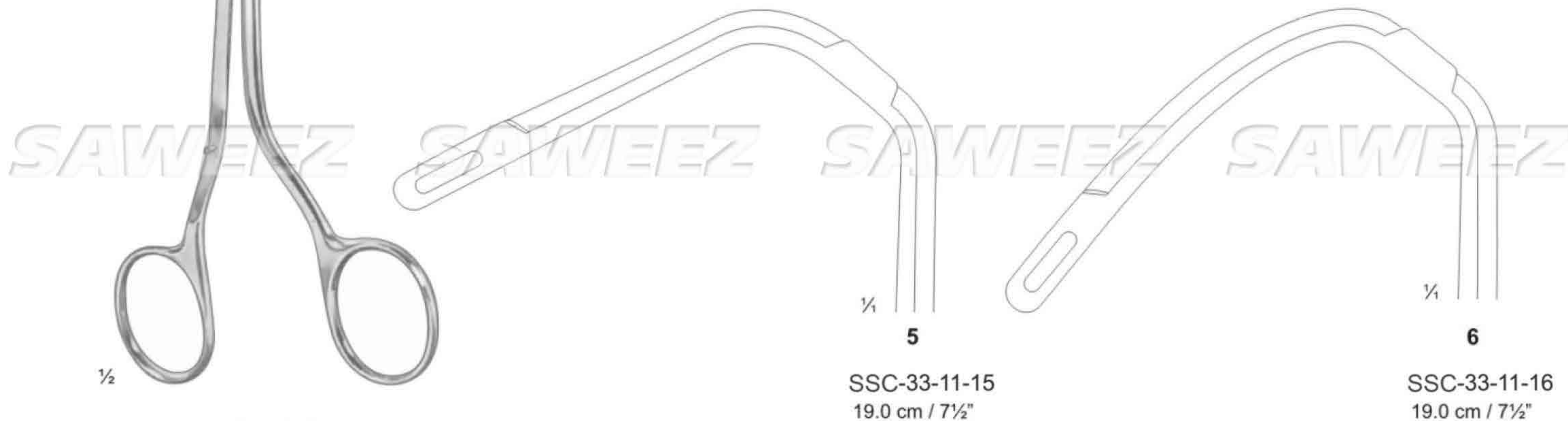


1
SSC-33-11-11
23.0 cm / 9"

2
SSC-33-11-12
22.0 cm / 8¾"

3
SSC-33-11-13
22.0 cm / 8¾"

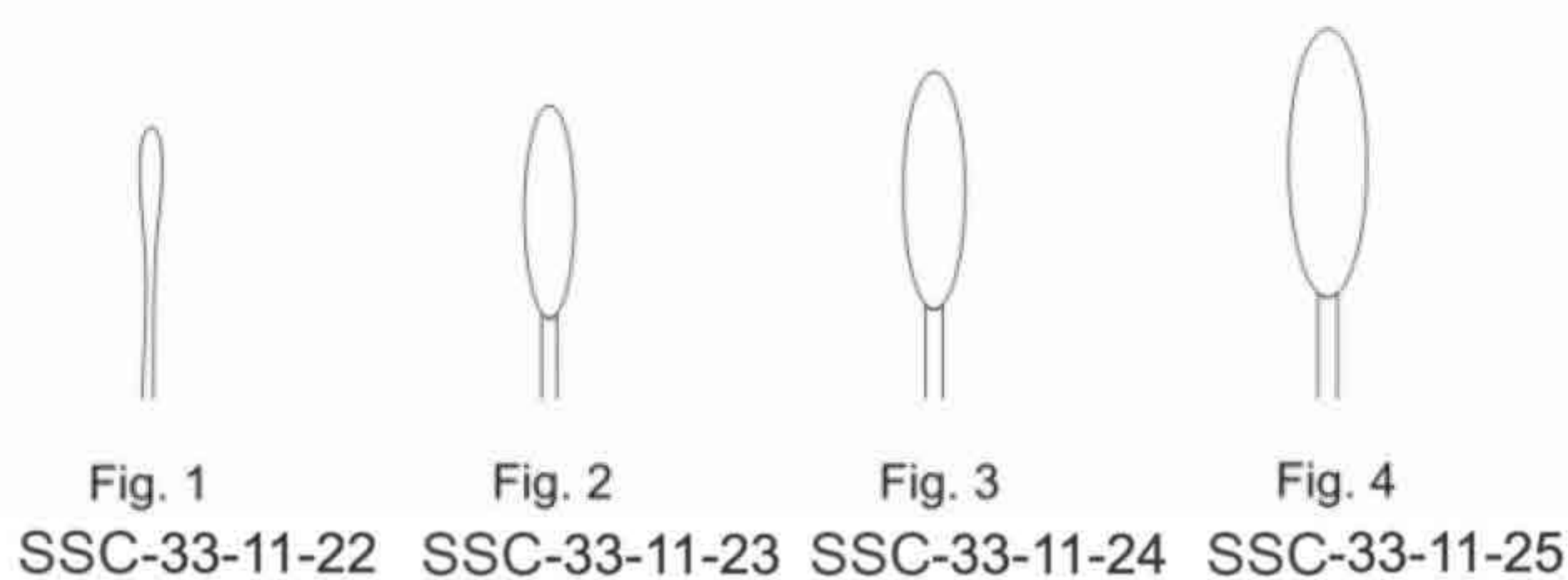
4
SSC-33-11-14
22.0 cm / 8¾"



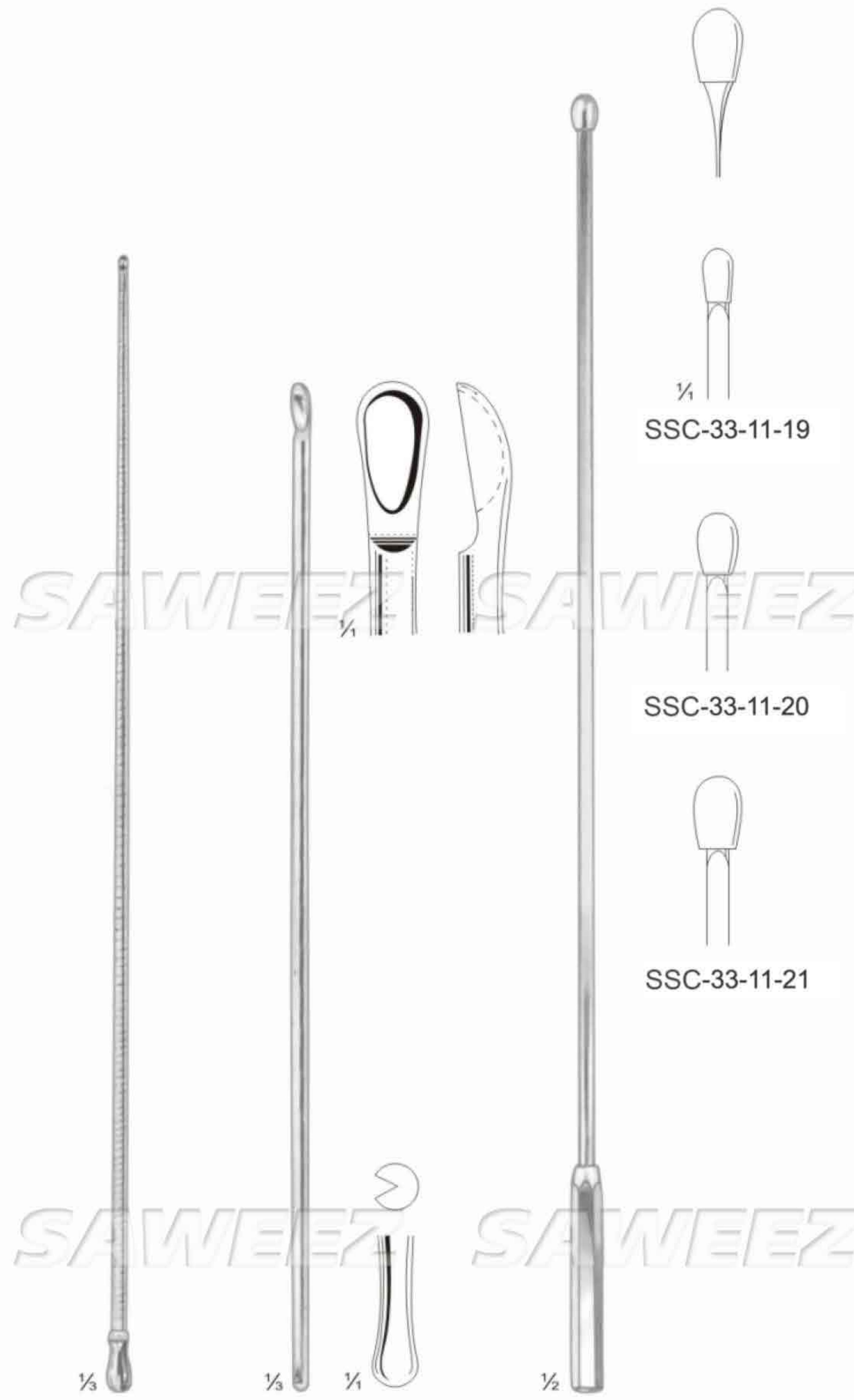
5
SSC-33-11-15
19.0 cm / 7½"

6
SSC-33-11-16
19.0 cm / 7½"

1/2
Randall



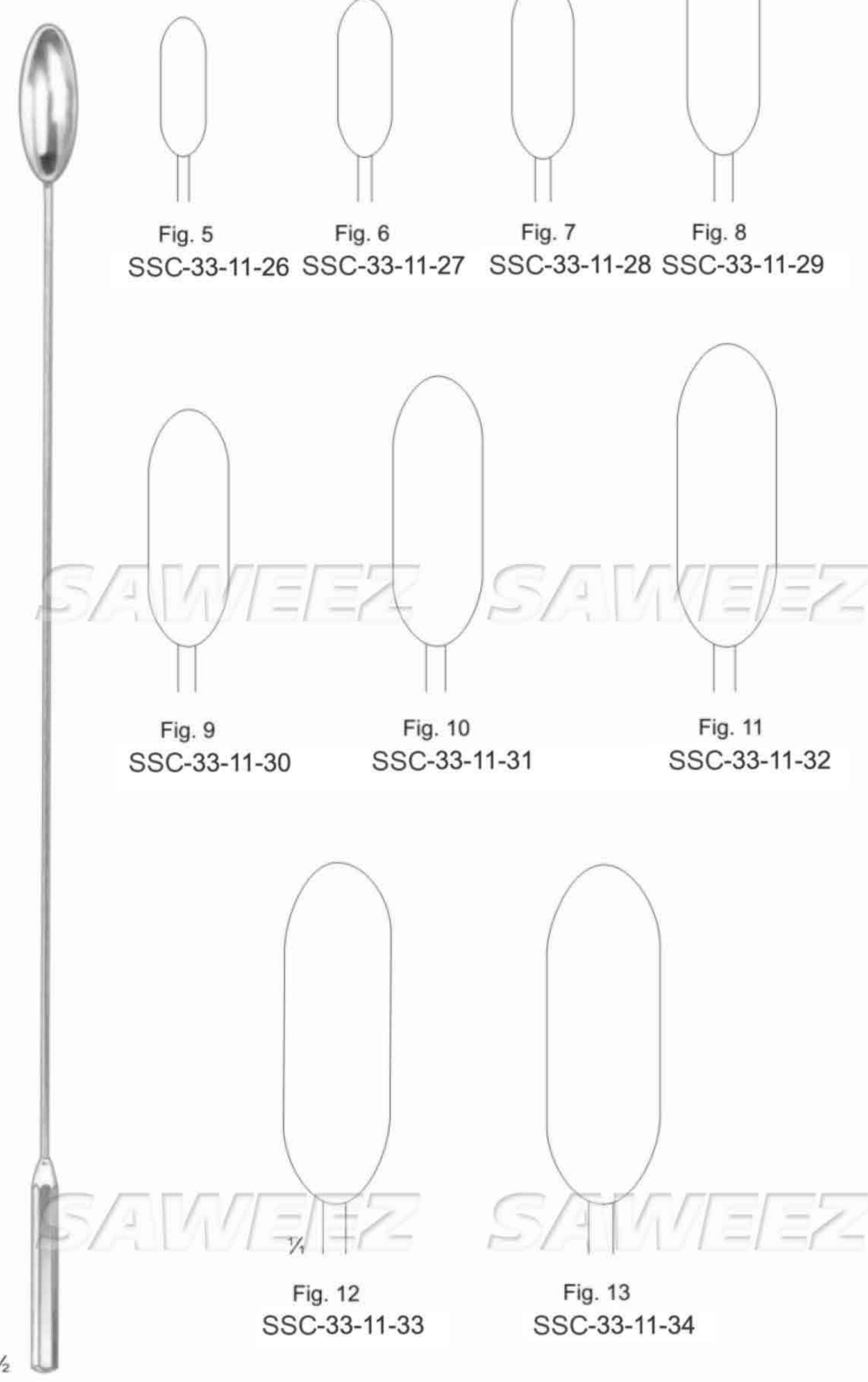
SAWEEZ SAWEEZ SAWEEZ SAWEEZ



Ochsner
SSC-33-11-17
38.0 cm / 15"

Moynihan
SSC-33-11-18
34.0 cm / 13½"
malleable

Desjardins
28.0 cm / 11"
elastic



Bakes
30.0 cm / 12"
malleable shaft



SSC-33-11-35
20.0 cm / 8"

Mayo-Blake



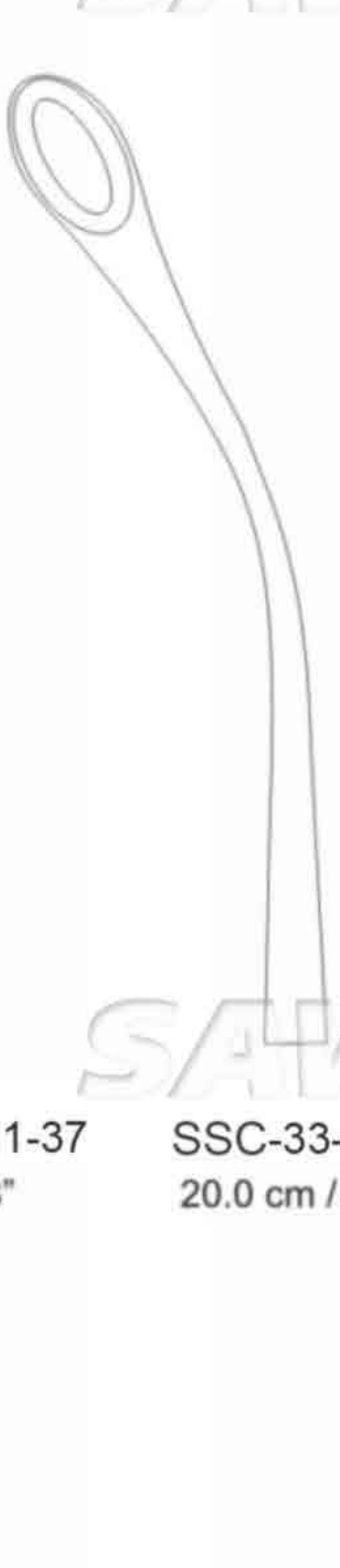
SSC-33-11-36
20.0 cm / 8"

Mayo-Blake



SSC-33-11-37
20.0 cm / 8"

Blake



SSC-33-11-38
20.0 cm / 8"

Mixer



SSC-33-11-39
22.0 cm / 8 3/4"



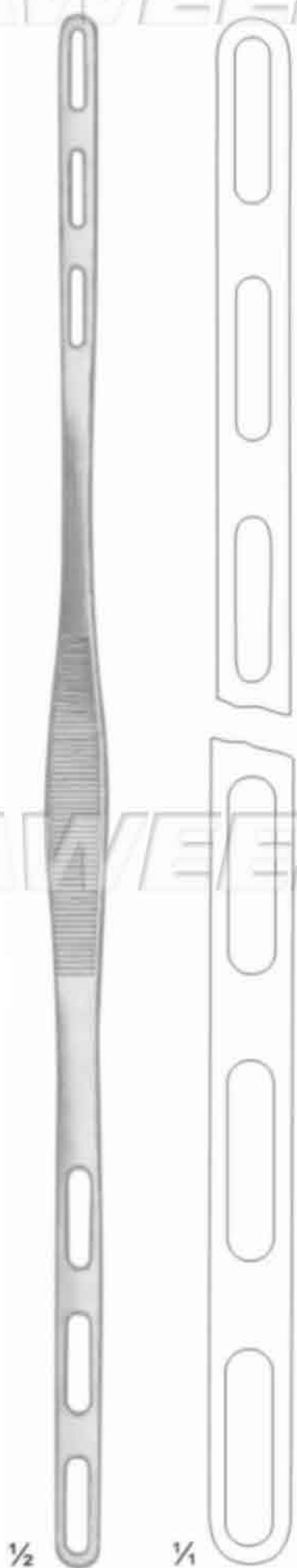
Desjardins
23.0 cm / 9"



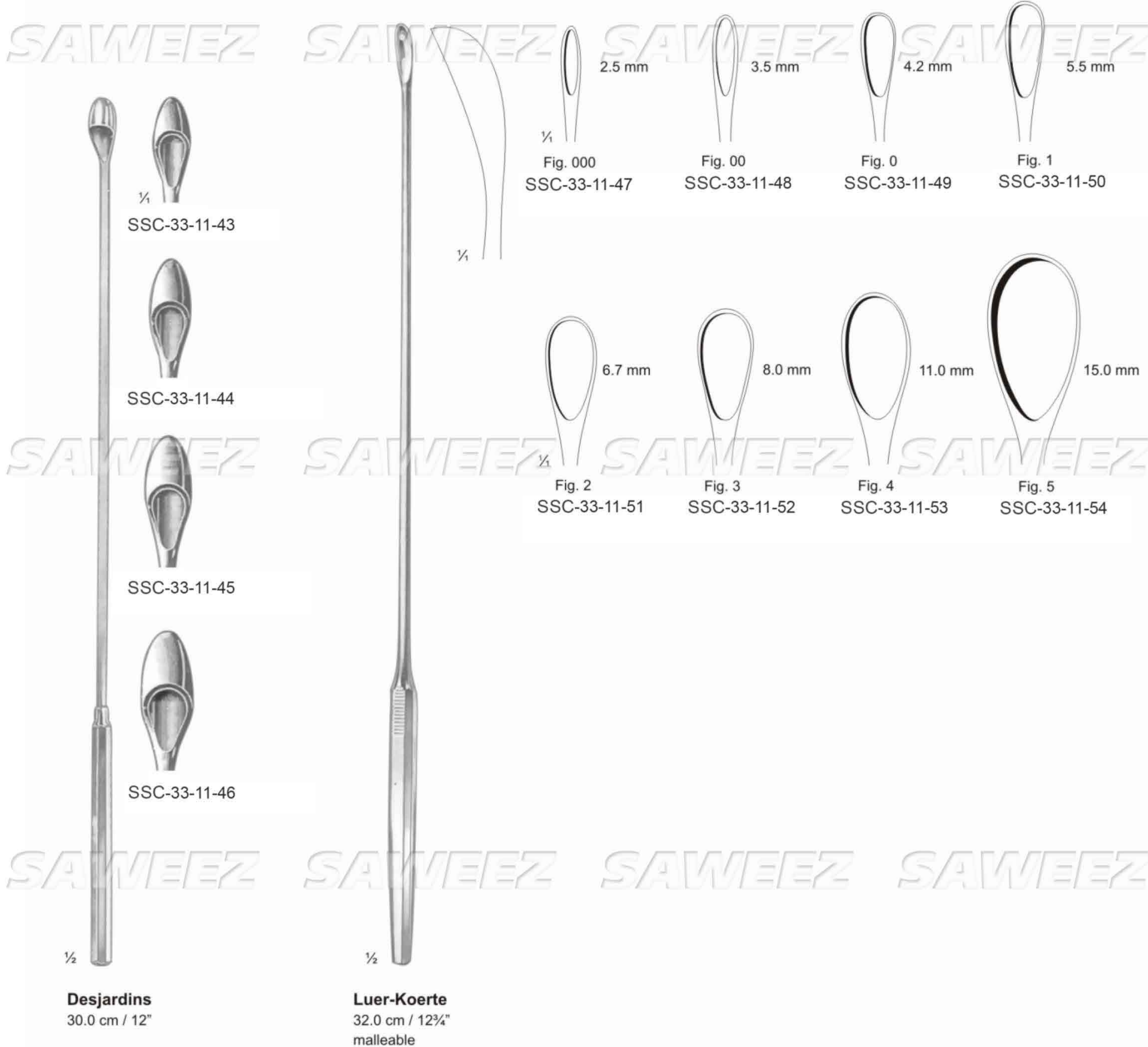
SSC-33-11-40



SSC-33-11-41



SSC-33-11-42
26.5 cm / 10 1/2"
malleable





1/2

Moore
SSC-33-11-55
28.0 cm / 11"

1/2

Mayo
SSC-33-11-56
28.0 cm / 11"

1/2

SSC-33-11-57
34.0 cm / 12 1/2"

Fergusson

1/4

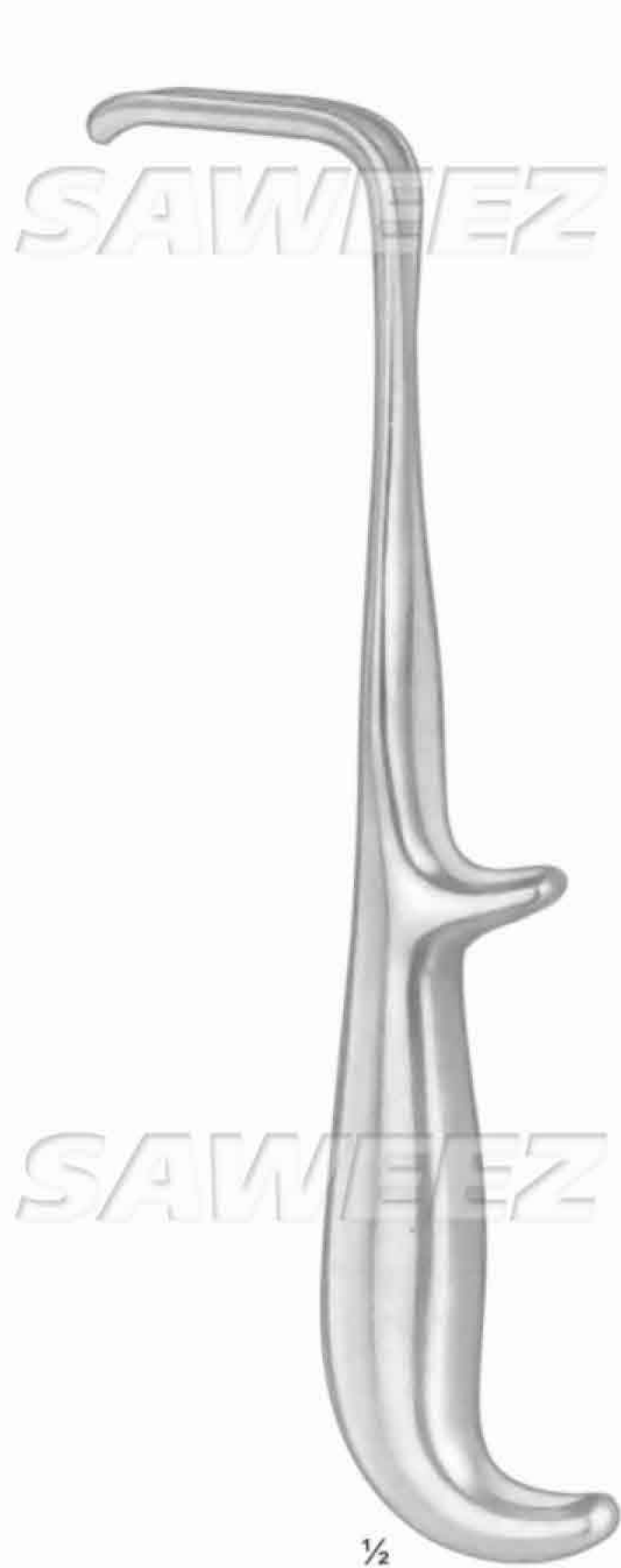
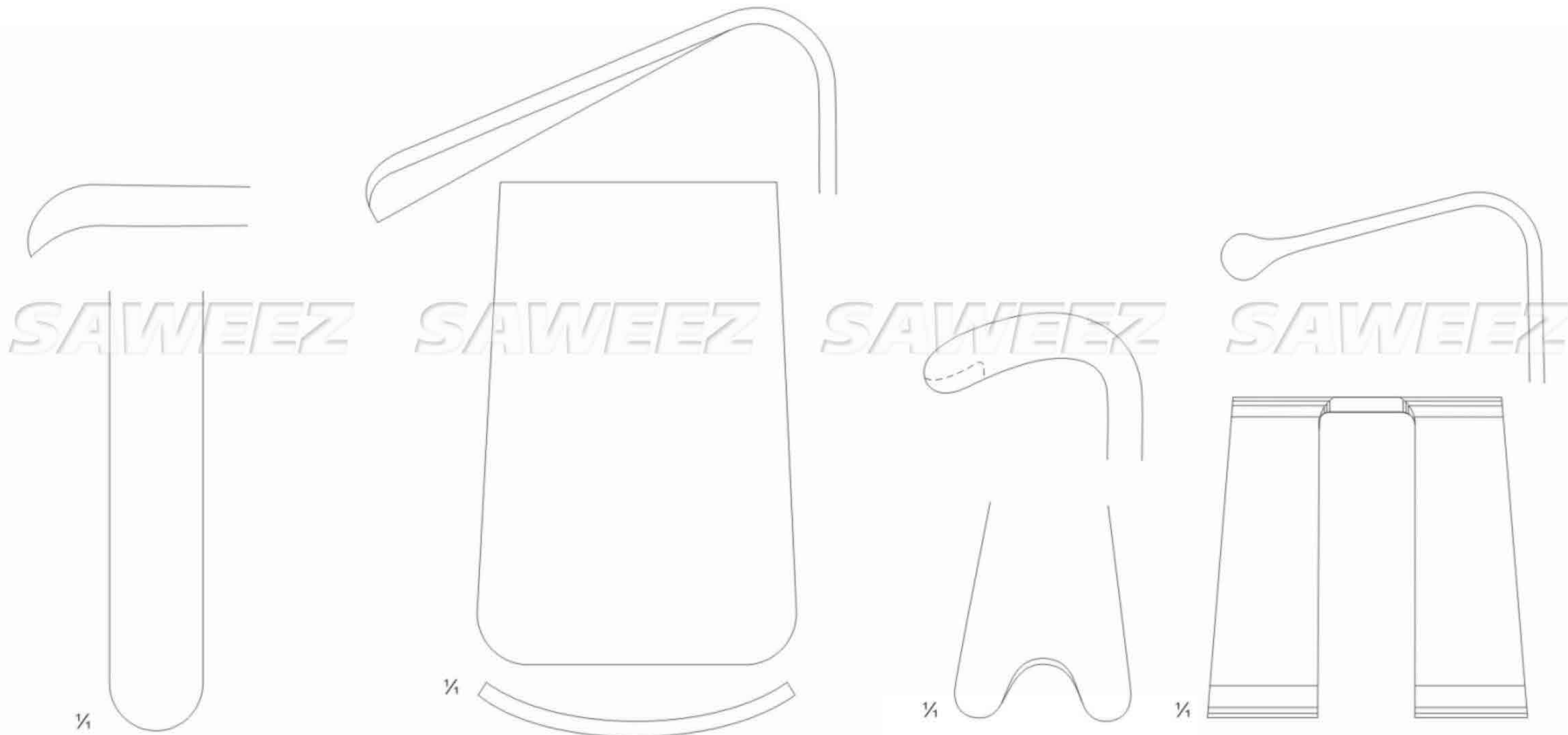
SSC-33-11-58
21.5 cm / 8 1/2"

2

SSC-33-11-59
22.0 cm / 8 3/4"

3

SSC-33-11-60
23.5 cm / 9 1/4"



Young
SSC-33-11-61
21.0 cm / 8 1/4"



Young
SSC-33-11-62
22.0 cm / 8 1/4"



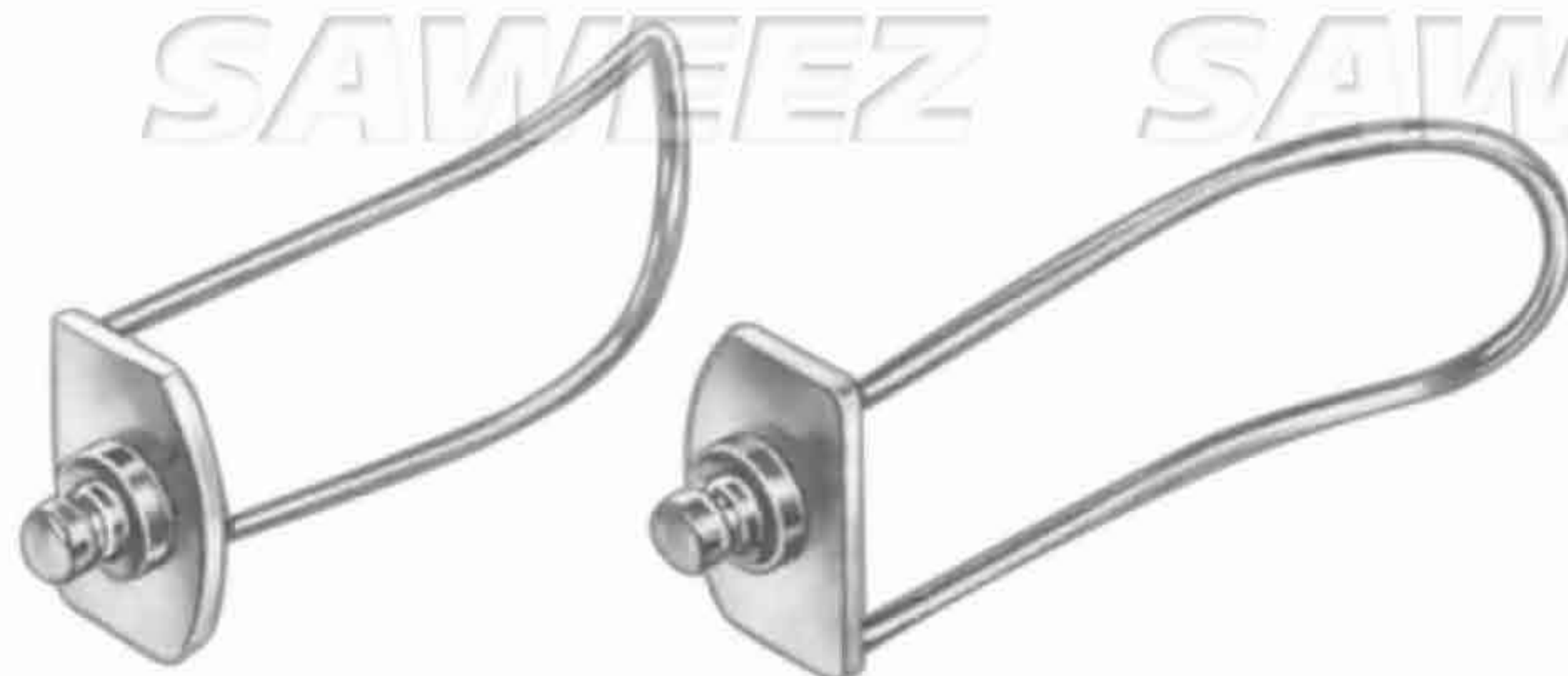
Young
SSC-33-11-63
21.0 cm / 8 1/4"



Young
SSC-33-11-64
22.0 cm / 8 1/4"

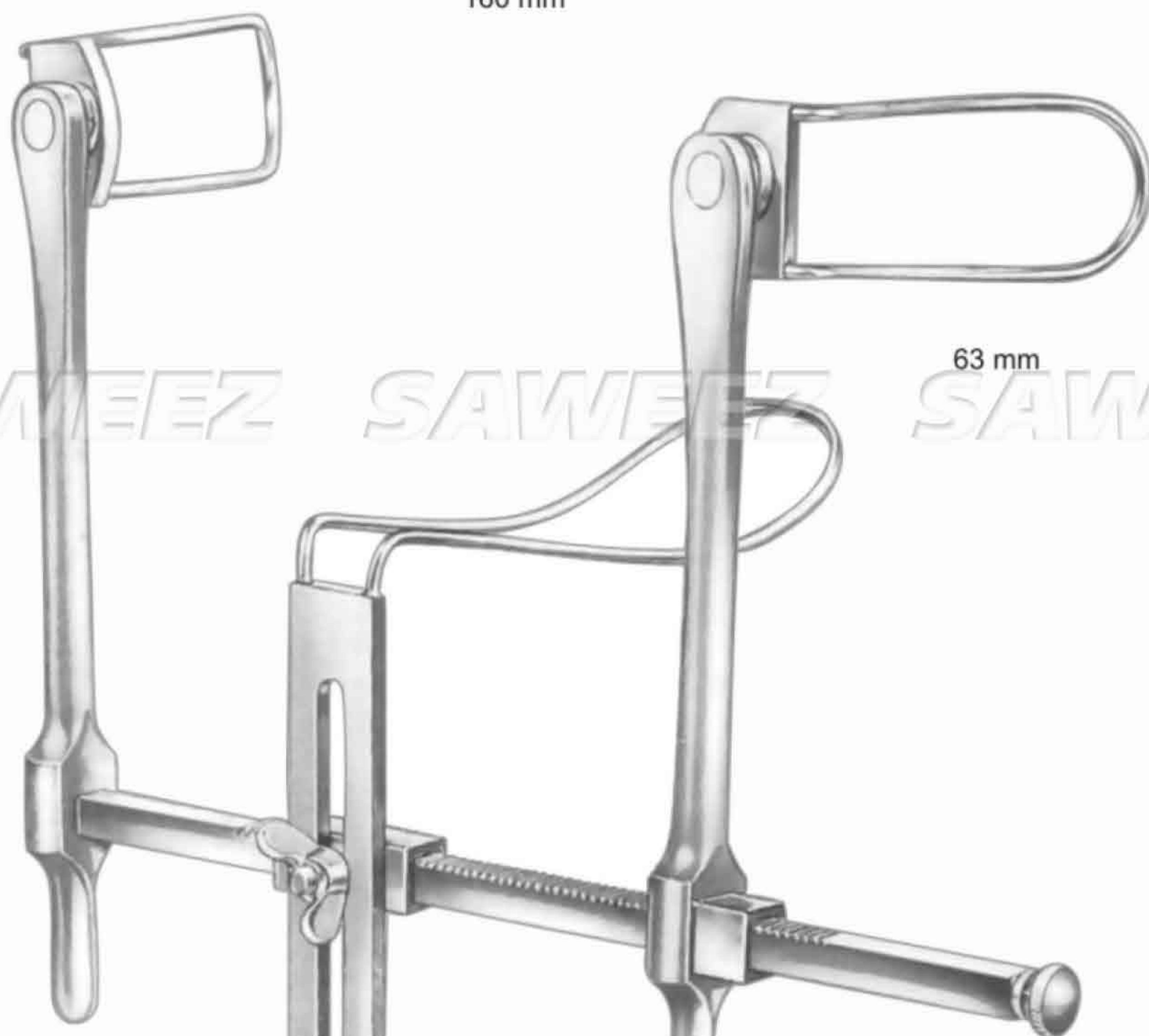


SAWEEZ SAWEEZ SAWEEZ SAWEEZ



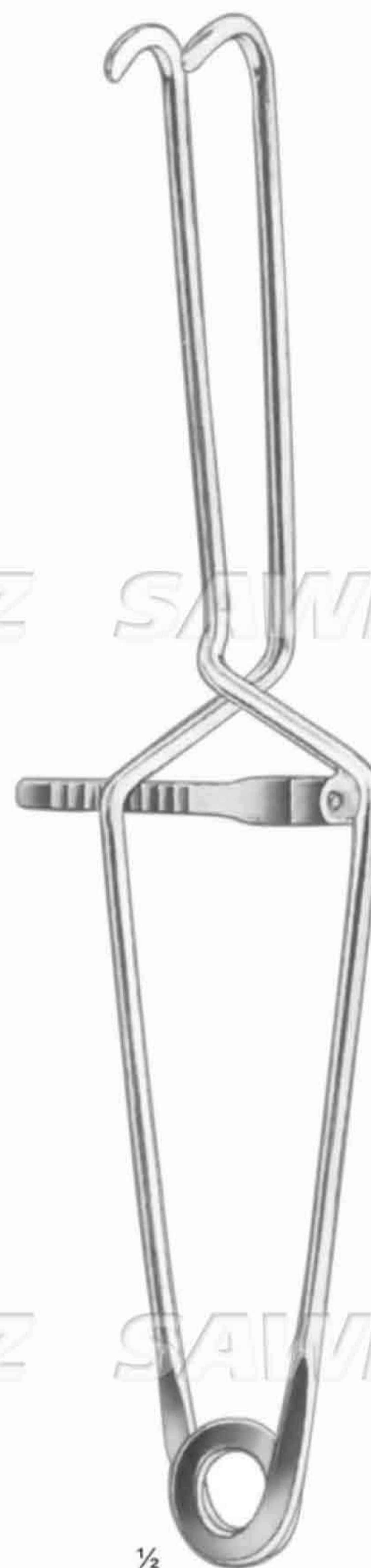
160 mm

SAWEEZ SAWEEZ SAWEEZ SAWEEZ



63 mm

SAWEEZ SAWEEZ SAWEEZ SAWEEZ



1/2

1/2

Gosset
SSC-33-11-65
Bladder Retractor

Millin
SSC-33-11-66
Bladder Neck Retractor



SAWEEZ SAWEEZ SAWEEZ SAWEEZ



SSC-33-11-71
35.0 cm / 13 3/4"

Ditten
SSC-33-11-67
NO. 8-30 (French)

Van Buren
SSC-33-11-68
NO. 8-36 (French)

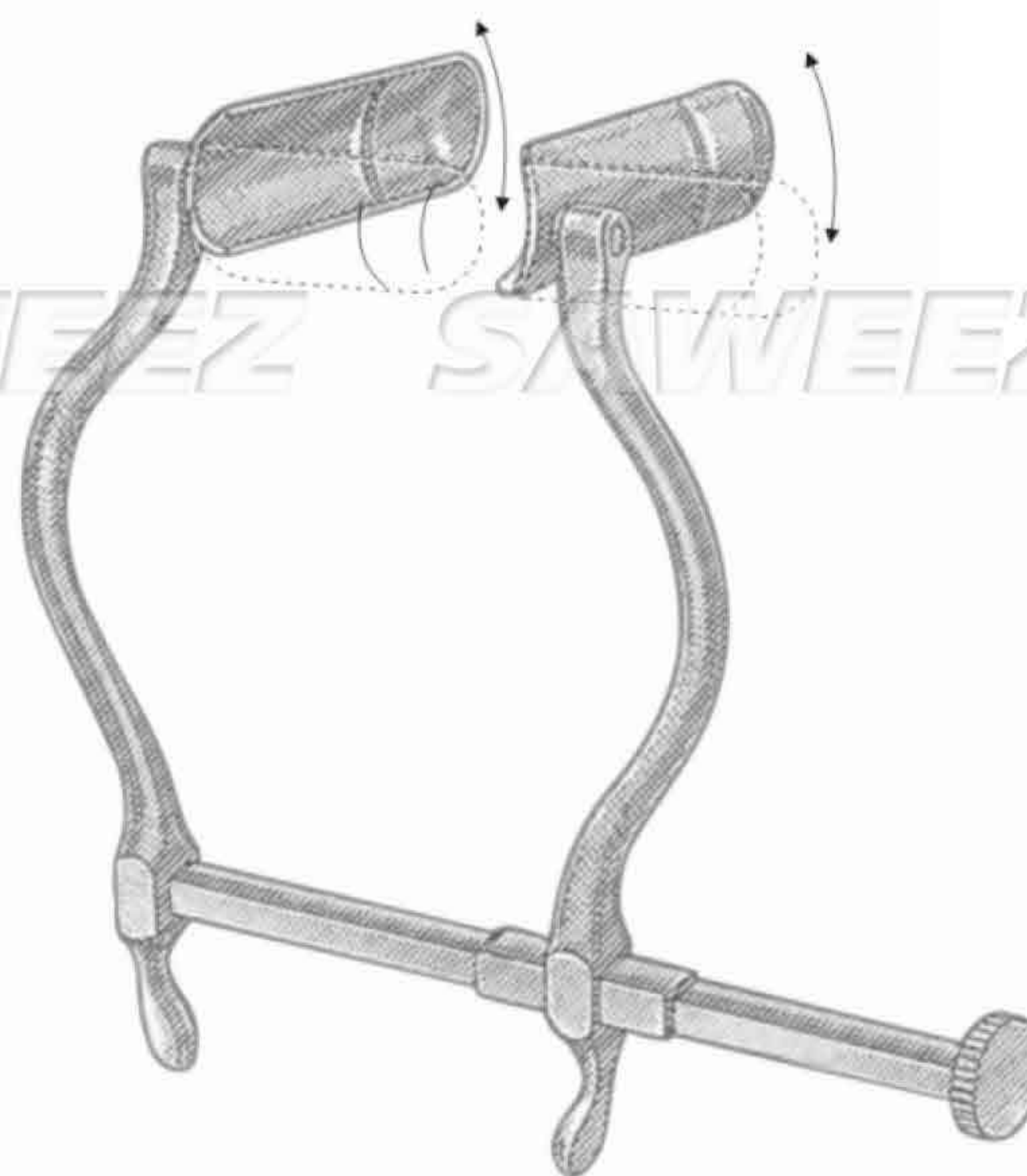
Guyon
SSC-33-11-69
NO. 10-30 (French)

Guyon
SSC-33-11-70
NO. 10-30 (French)

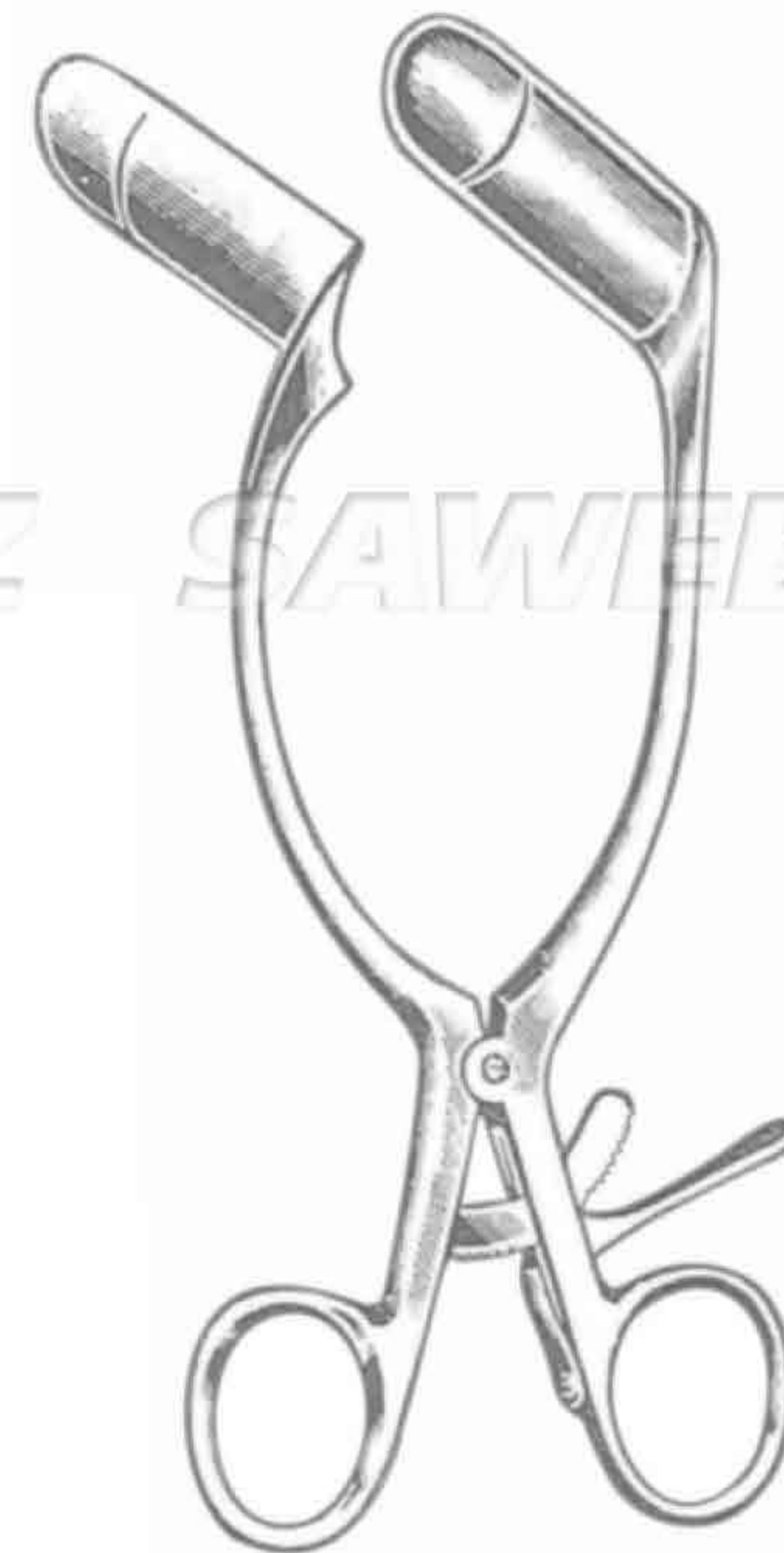
Catheter
SSC-33-11-71
39.0 cm / 15 1/2"
straight

**Fansler Operating Speculum**

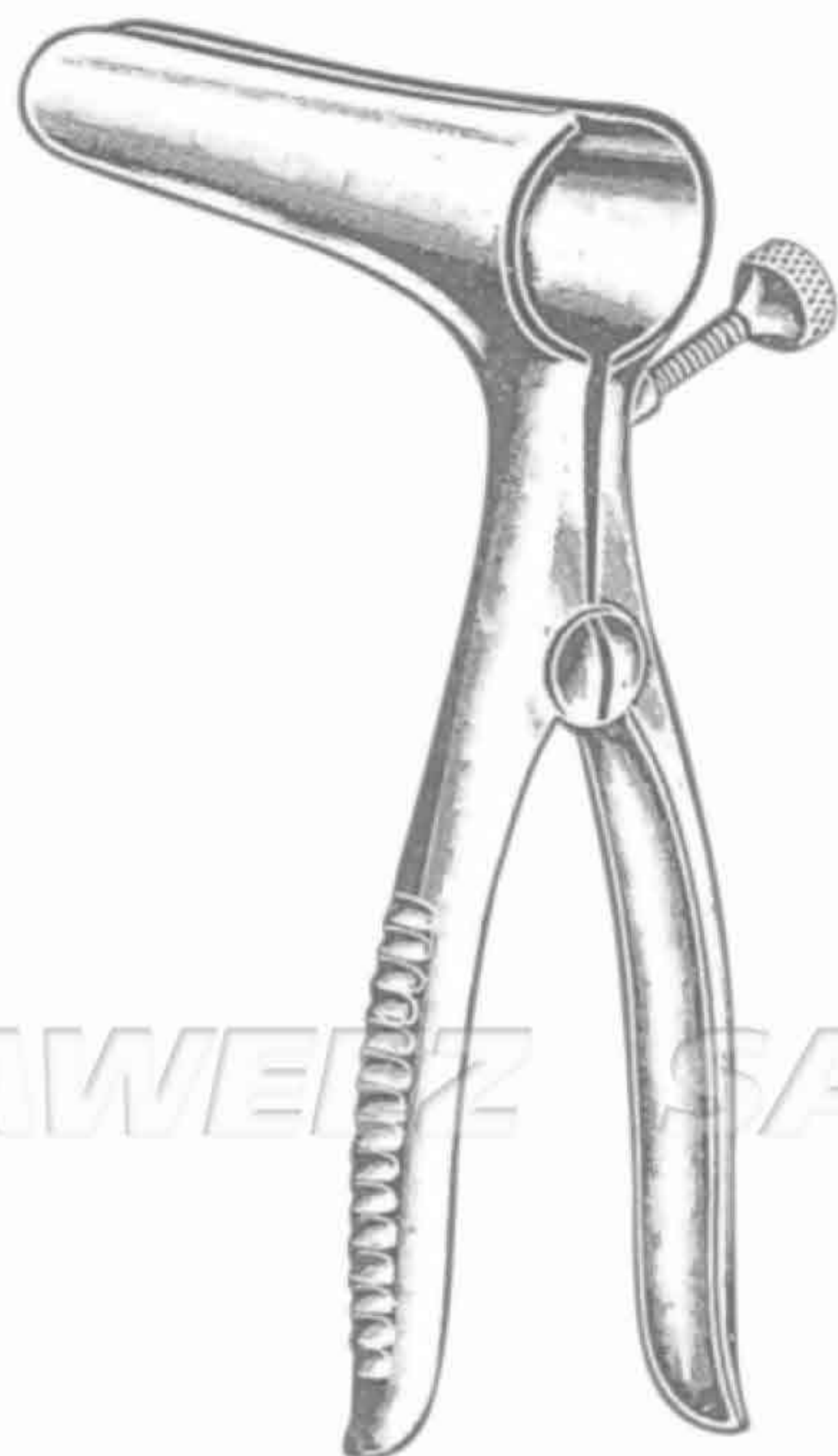
SSC-35-11-11

slotted tube, 2 $\frac{3}{8}$ " long x 1 $\frac{1}{4}$ "
diameter (6cm x 3.2cm)**Smith Anal Retractor**

SSC-35-11-12

maximum opening 10.2 cm / 4"
swivel blades 2 $\frac{3}{4}$ " deep x $\frac{7}{8}$ "
wide (7cm x 2.2cm)**Barr Anal Retractor**

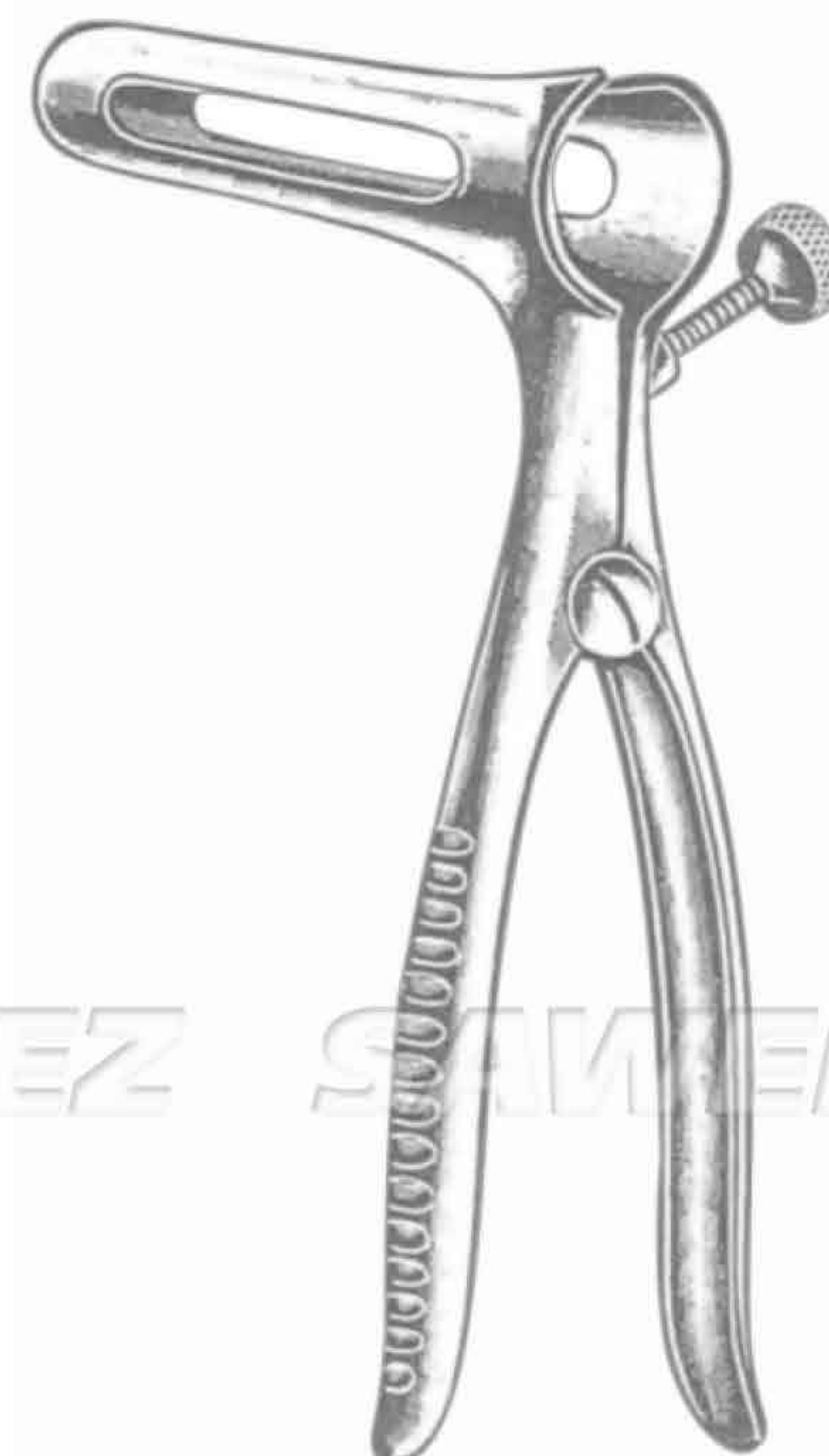
SSC-35-11-13

20.0cm/8", self-retaining
blades 2 $\frac{3}{4}$ " deep x $\frac{7}{8}$ "
wide (7cm x 2.2cm)**Pratt Rectal Speculum**

SSC-35-11-14

blades 3 $\frac{1}{2}$ " deep x 1" wide (8.9cm x 2.5cm)
diameter at opening 1 $\frac{3}{4}$ " (4.4cm)**Bodenhammer Rectal Speculum**

SSC-35-11-15

blades 3 $\frac{1}{2}$ " deep x $\frac{3}{4}$ " wide (8.9cm x 1.9cm)
diameter at opening $\frac{7}{8}$ " (2.2cm)**Sims Rectal Speculum**

SSC-35-11-16

blades 3 $\frac{1}{2}$ " deep x $\frac{7}{8}$ " wide (8.9cm x 2.2cm)
diameter at opening $\frac{5}{8}$ " (1.6cm), fenestrated



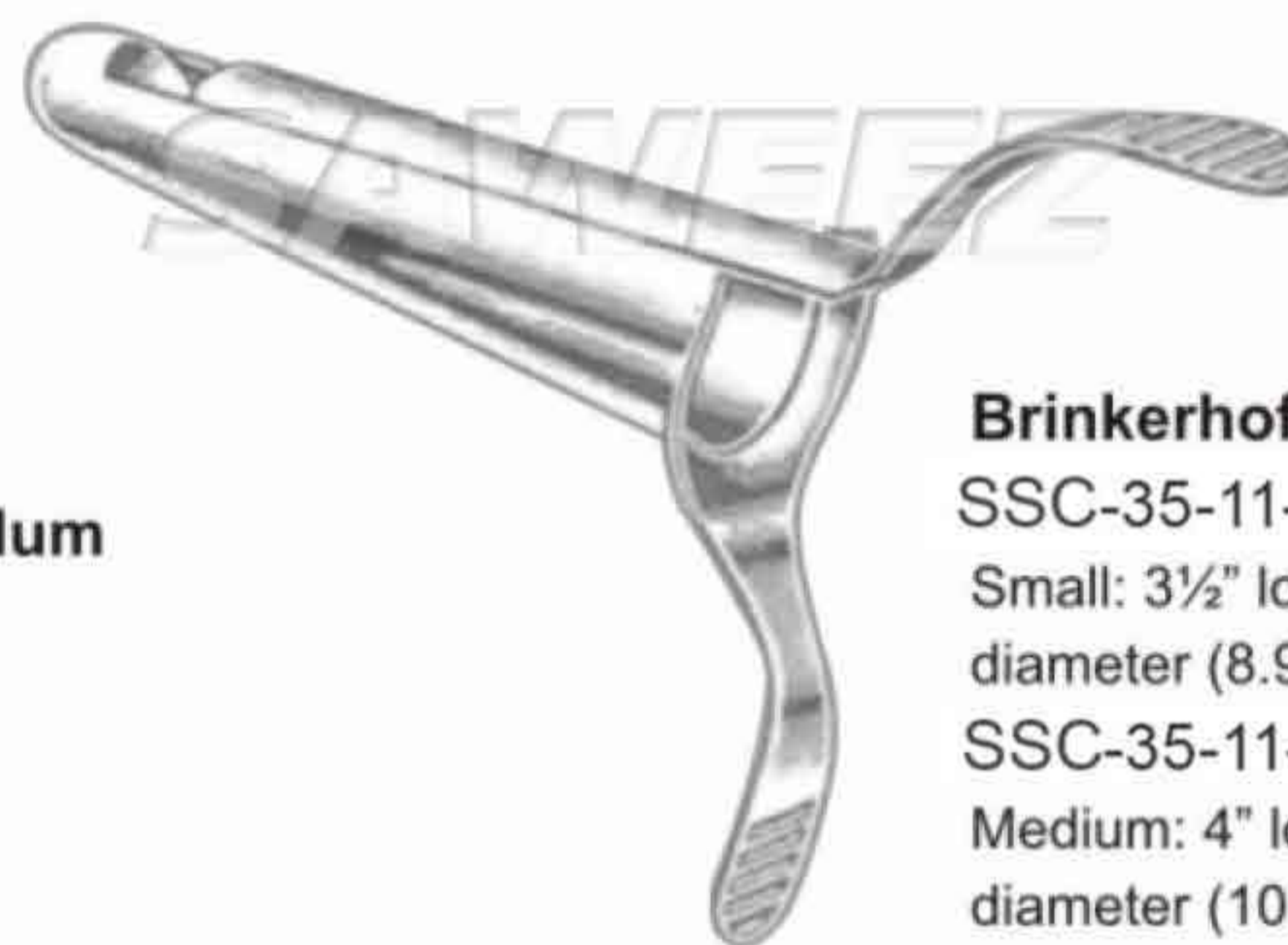
Fansler (Ives) Rectal Speculum
SSC-35-11-17
3¼" long x 1" diameter (8.3cm x 2.5cm)



Hirschman Anoscopes
SSC-35-11-23
Small- 2½" long x ¾" diameter (6.4cm x 1.4cm)
SSC-35-11-24
Medium- 2¾" long x 1¼" diameter (7cm x 1.7cm)
SSC-35-11-25
Large- 3½" long x 7⁄8" diameter (8.9cm x 2.2cm)



Chelsea-Eaton Anal Speculum
SSC-35-11-18
Small- 2½" long x 7⁄8" diameter (6.4cm x 2.2cm)
SSC-35-11-19
Large- 2½" long x 1¼" diameter (6.4cm x 3.1cm)



Brinkerhoff Rectal Specula
SSC-35-11-26
Small: 3½" long x 1" diameter (8.9cm x 2.5cm), tapering to ½" (1.3 cm)
SSC-35-11-27
Medium: 4" long x 1" diameter (10.2cm x 2.5cm), tapering to 5⁄8" (1.6cm)
SSC-35-11-28
Large: 4¾" long x 1¼" diameter (12.1cm x 3.2cm), tapering to ¾" (1.9cm)



Kelly Proctoscopes 7⁄8" diameter (2.2cm)
SSC-35-11-20- Small: long (5.1cm / 2")
SSC-35-11-21- Medium: long (10.2cm / 4")
SSC-35-11-22- Large: long (14.0cm / 5½")



Kelly Sphincteroscope
SSC-35-11-29
diameter (5.1cm x 2.5cm), tapering to 1¾" (2.1cm)



Hill-Ferguson Rectal Retractors

SSC-35-11-30- Small: 2½" x 7/8" wide (6.4cm x 2.2cm) blade

SSC-35-11-31- Large: 3" x 1 1/16" wide (7.6cm x 3cm) blade

SSC-35-11-32- Large: 3" x 1 1/16" wide (7.6cm x 3.6cm) blade



Sawyer Rectal Retractors

SSC-35-11-33- Small: 2½" x 7/8" wide (6.4cm x 2.2cm) blade

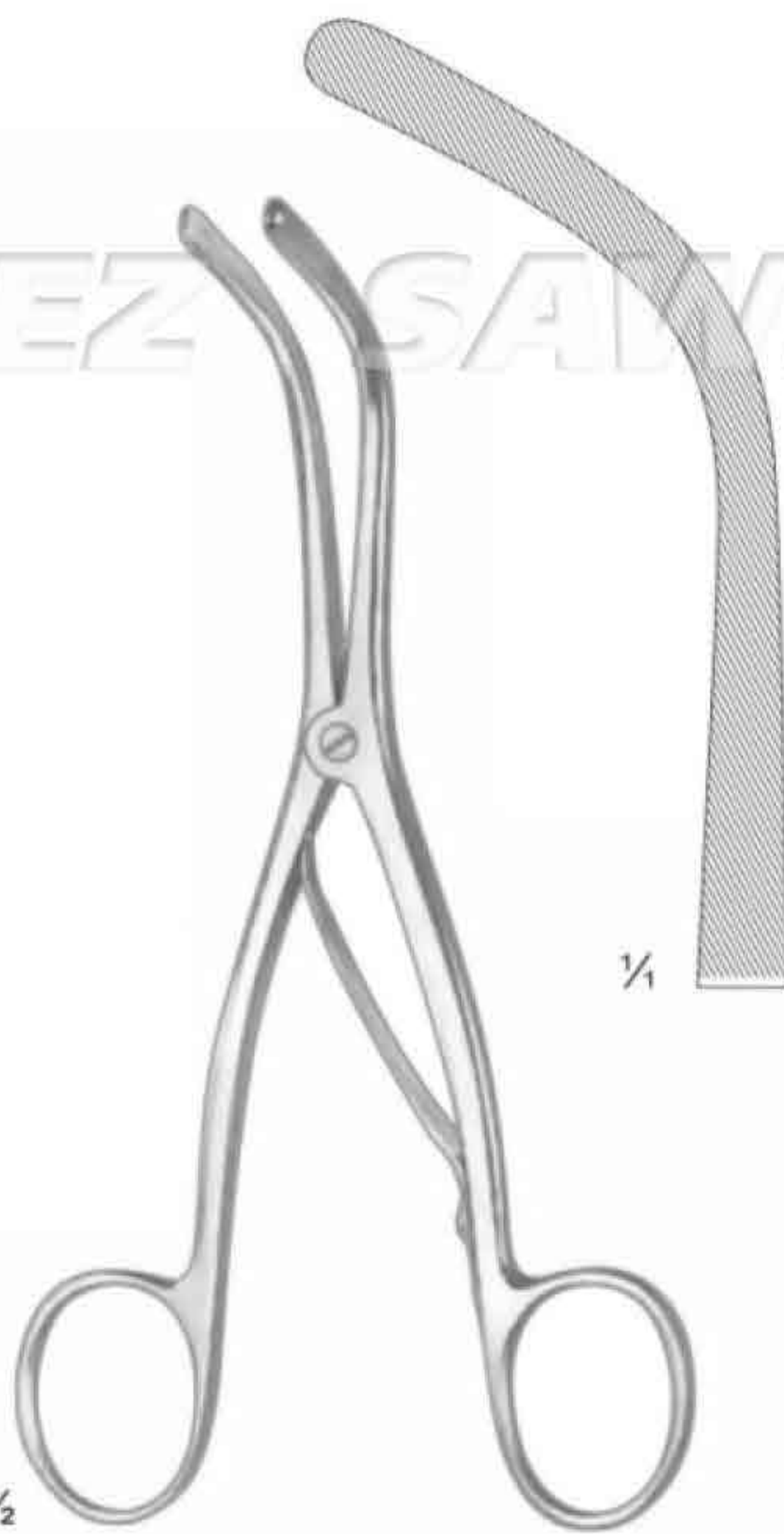
SSC-35-11-34- Medium: 3" x 1/8" wide (7.6cm x 2.9cm) blade

SSC-35-11-35- Large: 3½" x 1½" wide (8.9cm x 3.8cm) blade



1/2

Laborde
SSC-37-11-11
14.0 cm / 5 1/2"



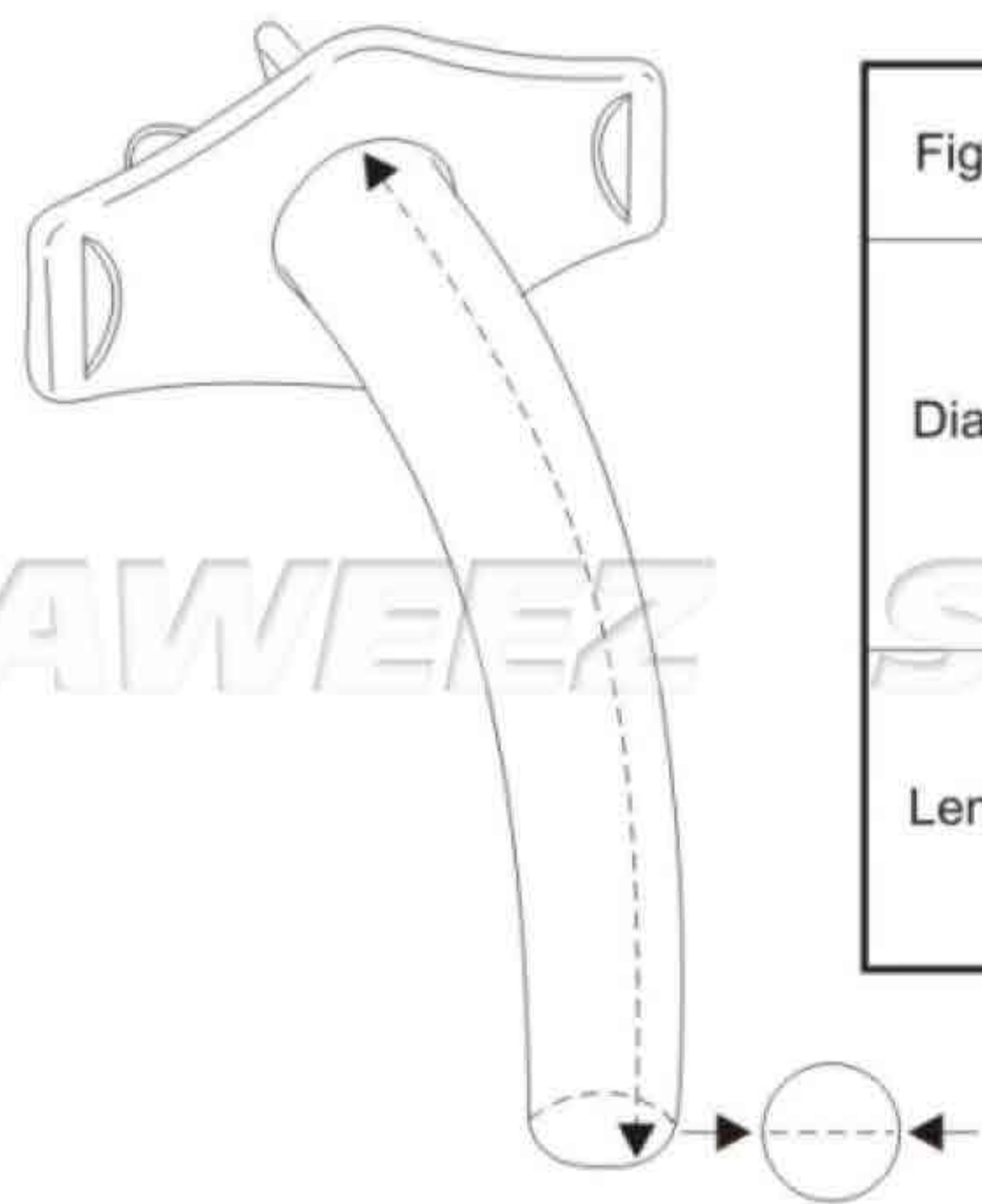
1/2

Trousseau
SSC-37-11-12
14.0 cm / 5 1/2"



1/2

Bose
SSC-37-11-13
7.0 cm / 2 3/4"



Jackson-Trachea Tubes

International Scale

	SSC-37-11-14	SSC-37-11-15	SSC-37-11-16	SSC-37-11-17	SSC-37-11-18	SSC-37-11-19	SSC-37-11-20	SSC-37-11-21	SSC-37-11-22	SSC-37-11-23
Figure	0	1	2	3	4	5	6	7	8	9
Diameter	4	5	6	7	8	9	10	11	12	13mm
Length of outer tube	45	50	55	60	65	70	75	80	85	90 mm

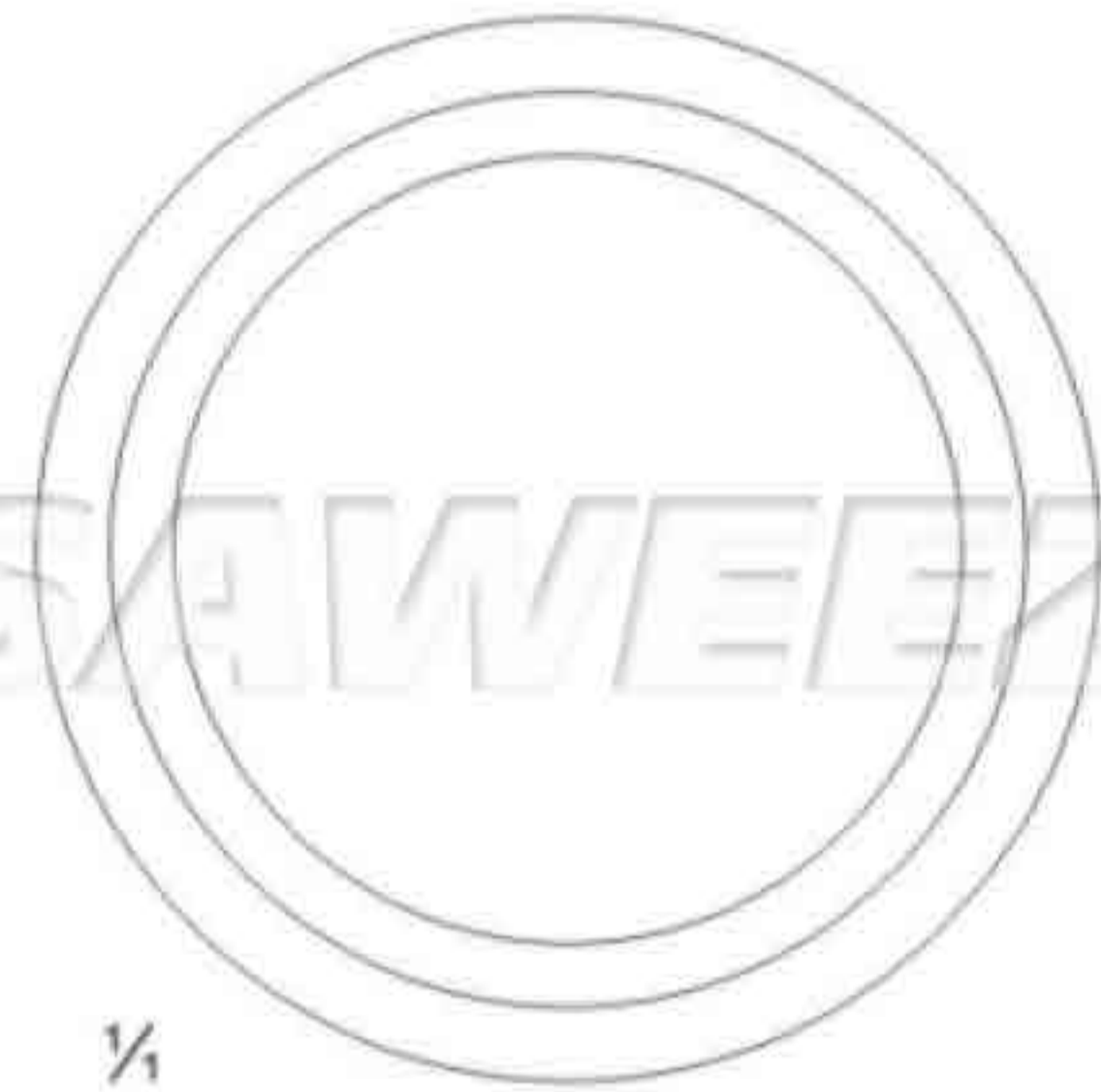
Length
from shield along outer
curvature to end of tube

Diameter (ø)
at the end of the outer tube
in millimeters



1/2

Metal Specula, tubular shape



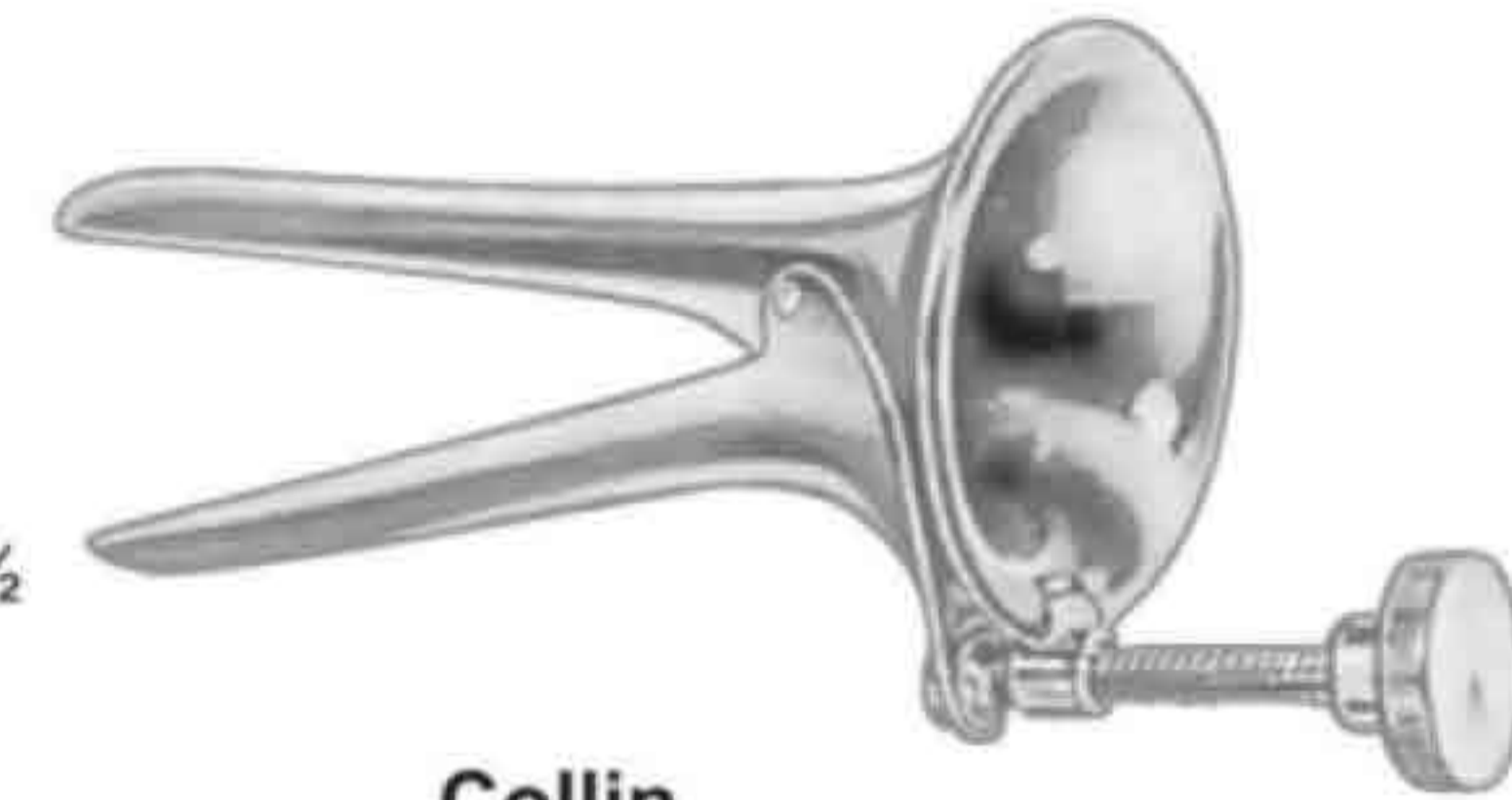
1/4

Fergusson

SSC-39-11-11 - 25 mm ø

SSC-39-11-12 - 30 mm ø

SSC-39-11-13 - 35 mm ø



1/2

Collin

SSC-39-11-14

55 x 10 mm



1/2

Cusco

SSC-39-11-15- 75 x 32 mm

SSC-39-11-16- 85 x 35 mm

SSC-39-11-17- 100 x 35 mm

Vaginal Specula with lateral ratchet, with folding handles

SSC-39-11-18- 85 x 35 mm

with interchangeable fiber optic light carrier
fiber optic light carrier



1/2

Cusco

SSC-39-11-19

75 x 17 mm

conical shape, virgin size



Cusco

- SSC-39-11-20 - 80 x 22 mm
- SSC-39-11-21 - 100 x 25 mm
- SSC-39-11-22 - 105 x 27 mm

Swiss pattern, narrow, with lateral ratchet, with folding handles

1/2

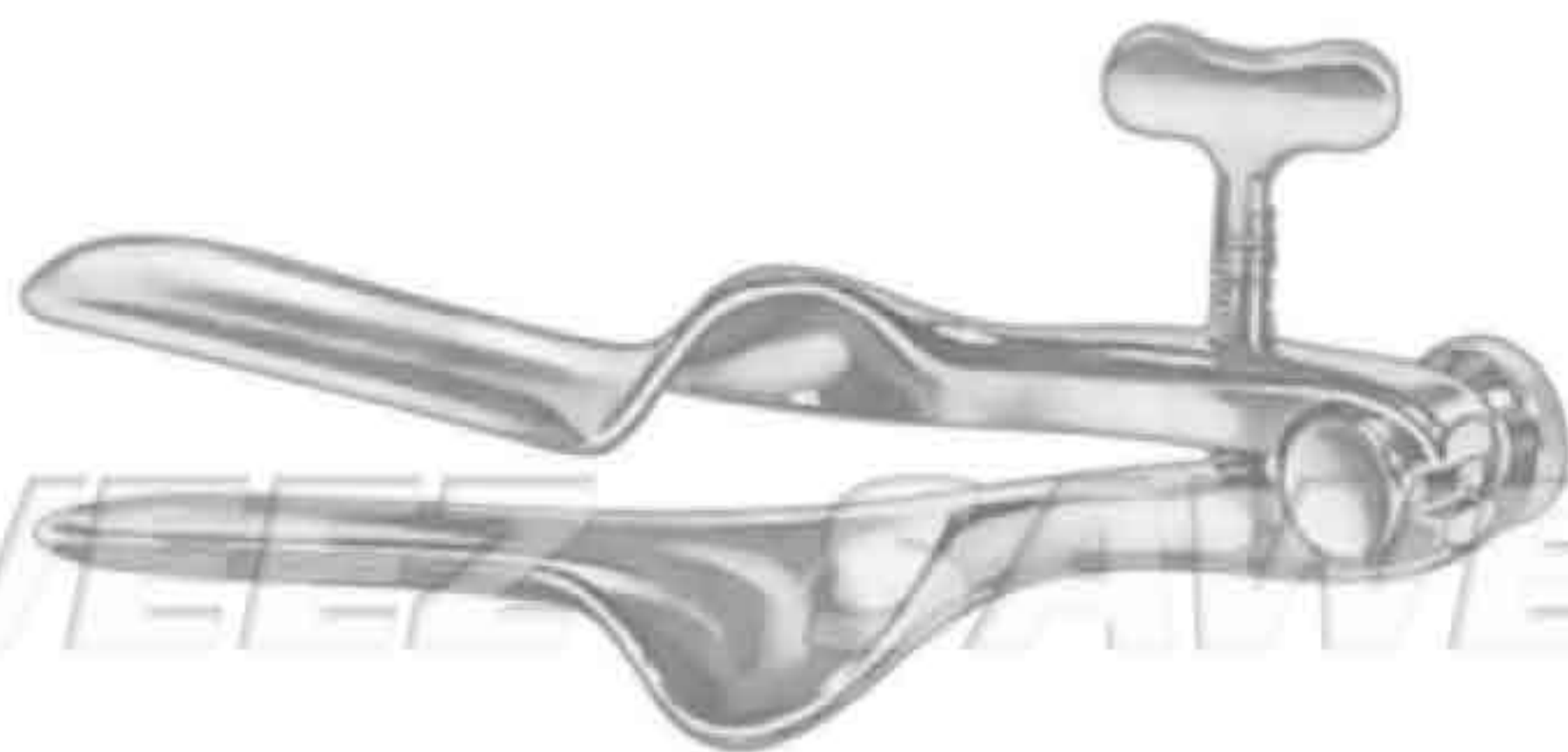


Cusco

- SSC-39-11-23 - 75 x 32 mm
- SSC-39-11-24 - 85 x 35 mm
- SSC-39-11-25 - 100 x 37 mm

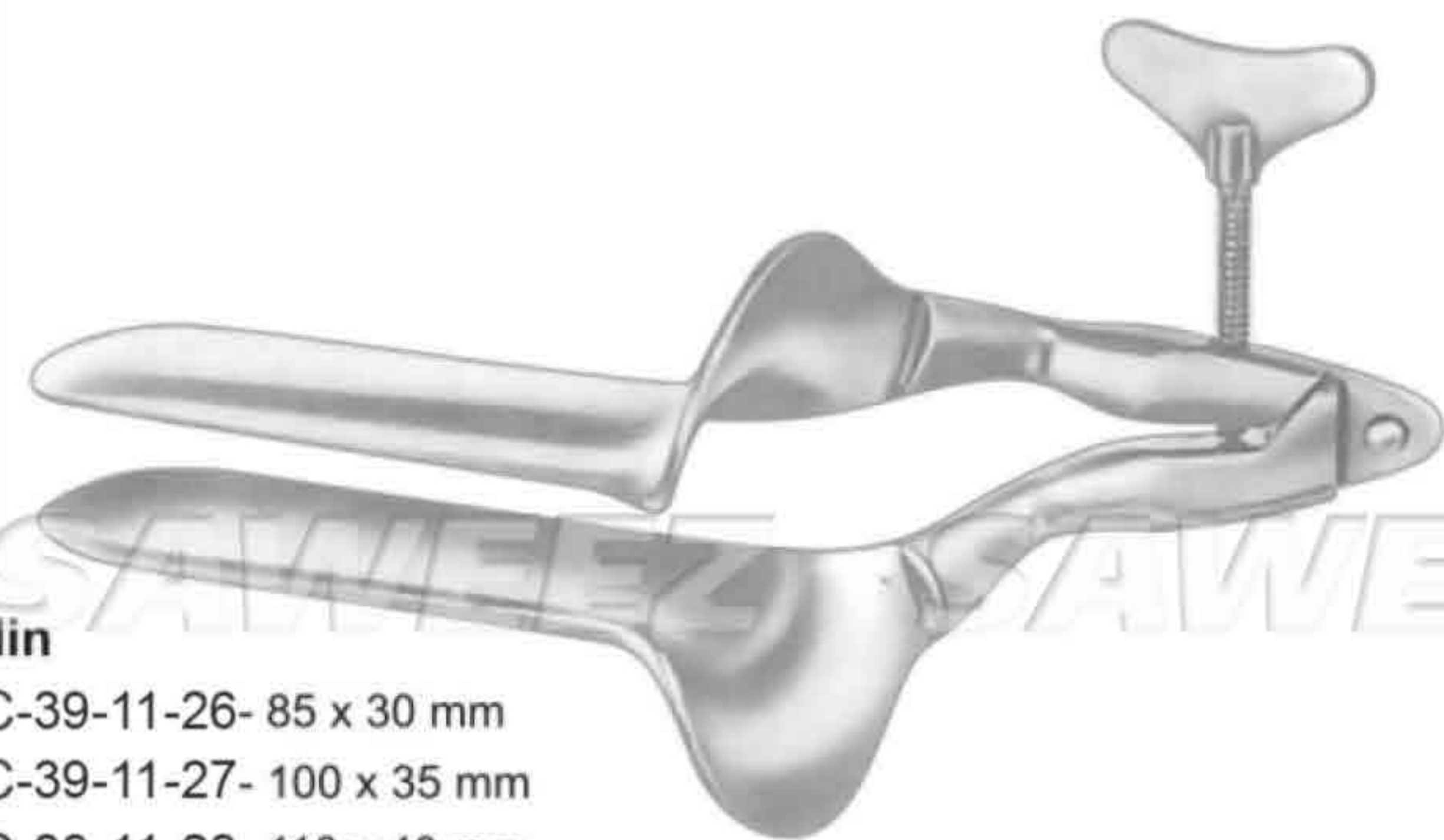
with ratchet at the folding handles

1/2



Collin

- SSC-39-11-30
- 65 x 20 mm



Collin

- SSC-39-11-26 - 85 x 30 mm
- SSC-39-11-27 - 100 x 35 mm
- SSC-39-11-28 - 110 x 40 mm
- SSC-39-11-29 - 100 x 35 mm

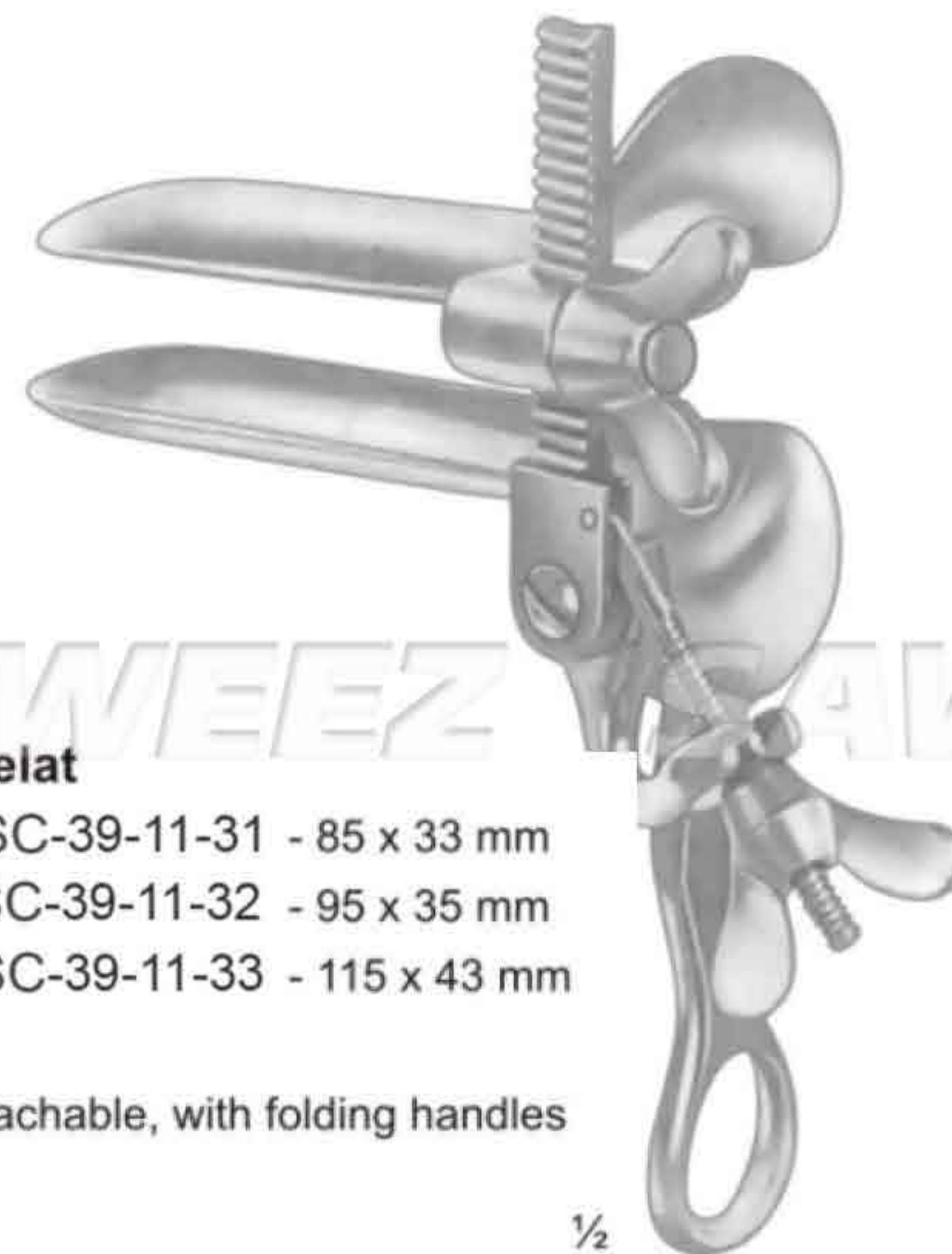
Detachable
with interchangeable fiberoptic light carrier



Collin-Lanau

- SSC-39-11-34
- 100 x 35 mm

1/2

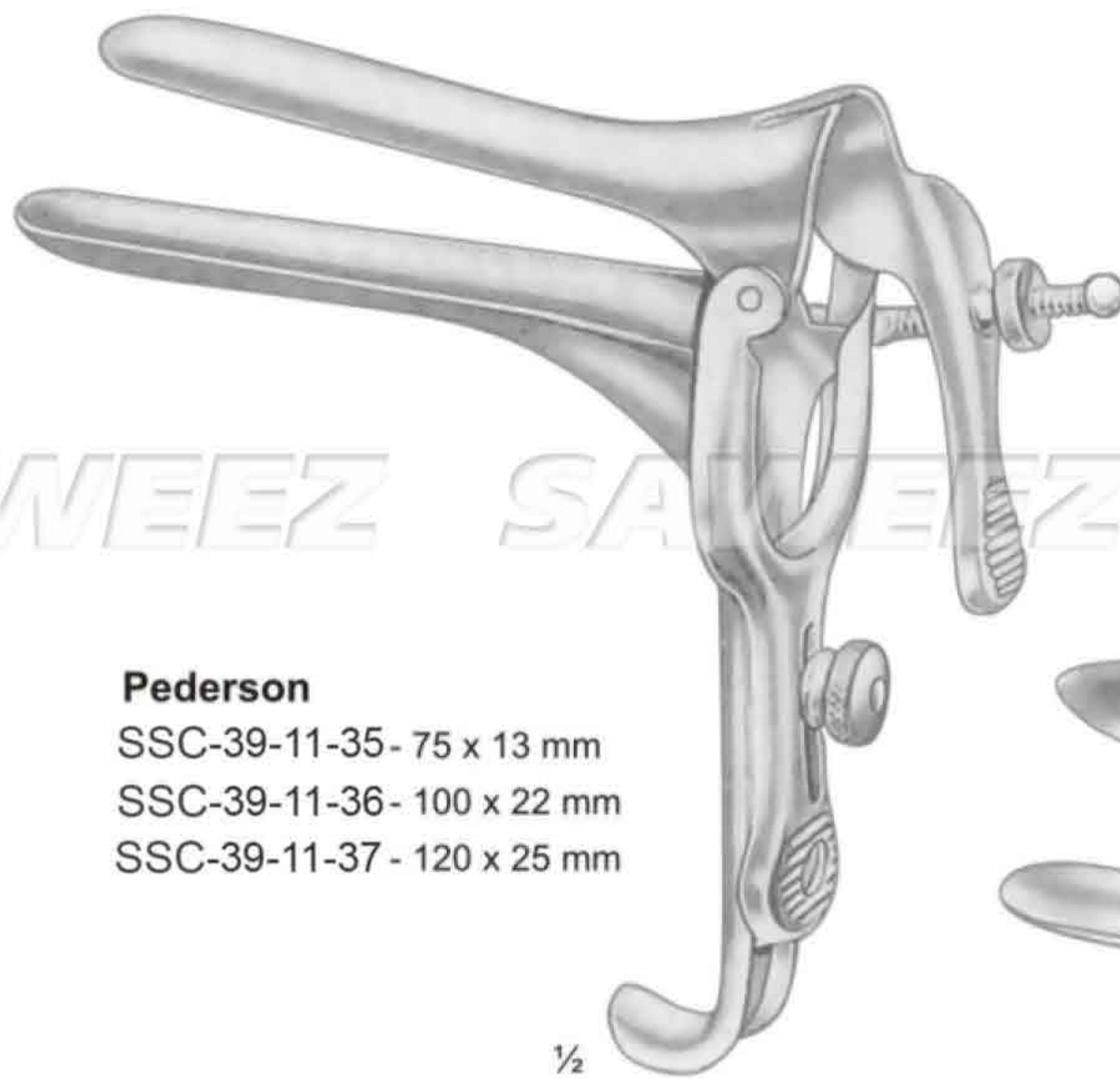


Trelat

- SSC-39-11-31 - 85 x 33 mm
- SSC-39-11-32 - 95 x 35 mm
- SSC-39-11-33 - 115 x 43 mm

detachable, with folding handles

1/2



Pederson

- SSC-39-11-35 - 75 x 13 mm
- SSC-39-11-36 - 100 x 22 mm
- SSC-39-11-37 - 120 x 25 mm

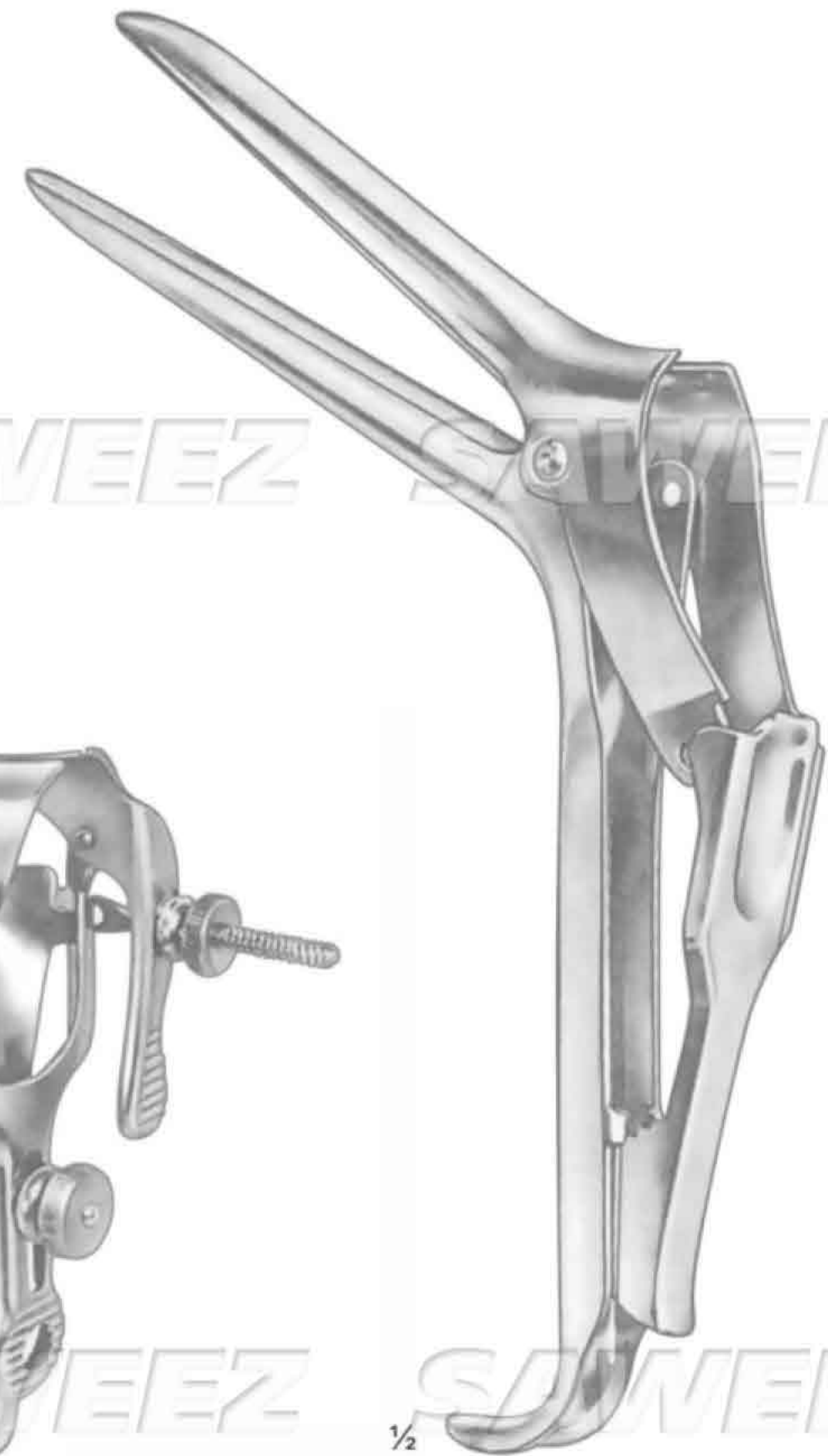
½



Graves

- SSC-39-11-38 - 75 x 20 mm
- SSC-39-11-39 - 95 x 35 mm
- SSC-39-11-40 - 115 x 35 mm

½



½

Semm

- SSC-39-11-41 - 100 x 17/20 r
- SSC-39-11-42 - 100 x 25/30 r



½

Kristeller Specula

- Fig.1 SSC-39-11-43 - 70 x 27 mm
- Fig.2 SSC-39-11-44 - 80 x 30 mm
- Fig.3 SSC-39-11-45 - 90 x 36 mm



½

Kristeller Retractors

- Fig.1 SSC-39-11-46 - 75 x 23 mm
- Fig.2 SSC-39-11-47 - 85 x 26 mm
- Fig.3 SSC-39-11-48 - 100 x 32 mm



½

Kristeller

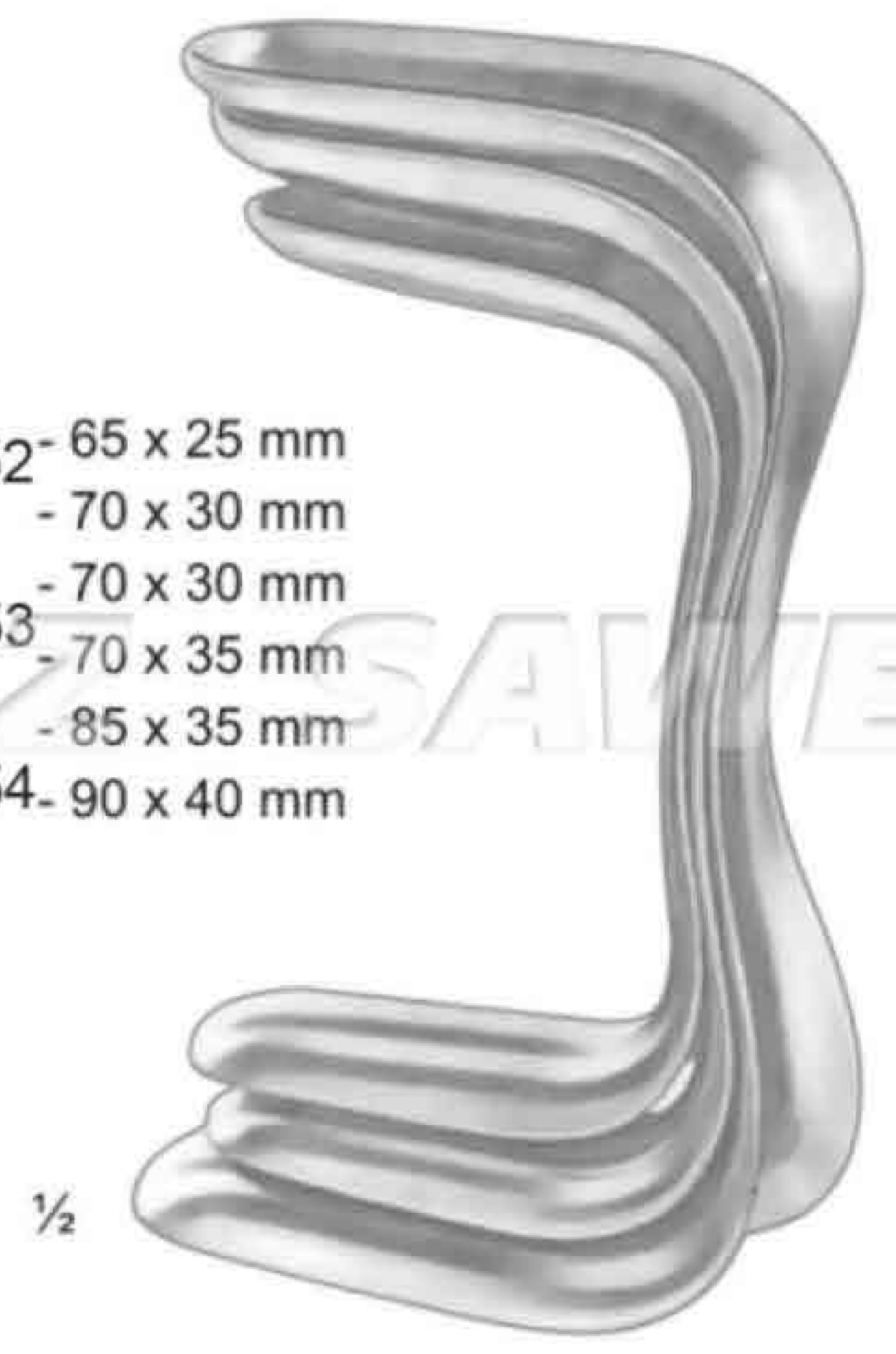
set of 1 speculum
and 1 retractor each

- Fig.1 SSC-39-11-49
- Fig.2 SSC-39-11-50
- Fig.3 SSC-39-11-51



Sims

- SSC-39-11-52 - 65 x 25 mm
- 70 x 30 mm
- SSC-39-11-53 - 70 x 30 mm
- 70 x 35 mm
- 85 x 35 mm
- SSC-39-11-54 - 90 x 40 mm



Jackson

- SSC-39-11-59 - 75 x 35 mm
- SSC-39-11-60 - 90 x 35 mm
- SSC-39-11-61 - 100 x 35 mm
- SSC-39-11-62 - 75 x 40 mm
- SSC-39-11-63 - 90 x 40 mm
- SSC-39-11-64 - 100 x 40 mm



with conically shaped blades, virgin sizes



- Kristeller Specula**
- SSC-39-11-55 - 105 x 18 mm
 - SSC-39-11-56 - 105 x 21 mm



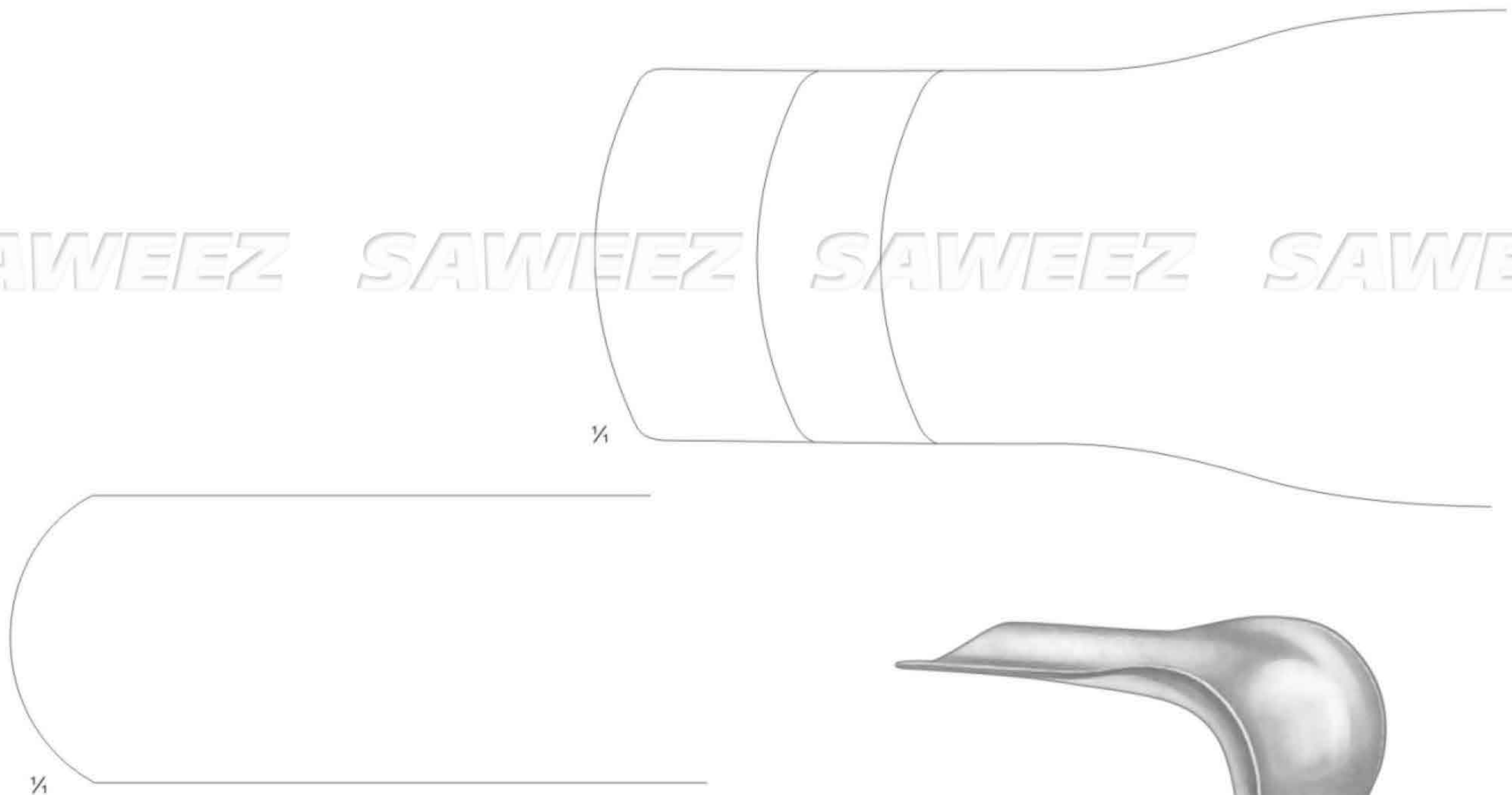
- Kristeller Retractors**
- SSC-39-11-57 - 110 x 14 mm
 - SSC-39-11-58 - 110 x 17 mm



- Kristeller**
- Set of 1 Speculum and 1 Retractors
 - SSC-39-11-65
 - SSC-39-11-66



SAWEEZ SAWEEZ SAWEEZ SAWEEZ



SAWEEZ SAWEEZ SAWEEZ SAWEEZ

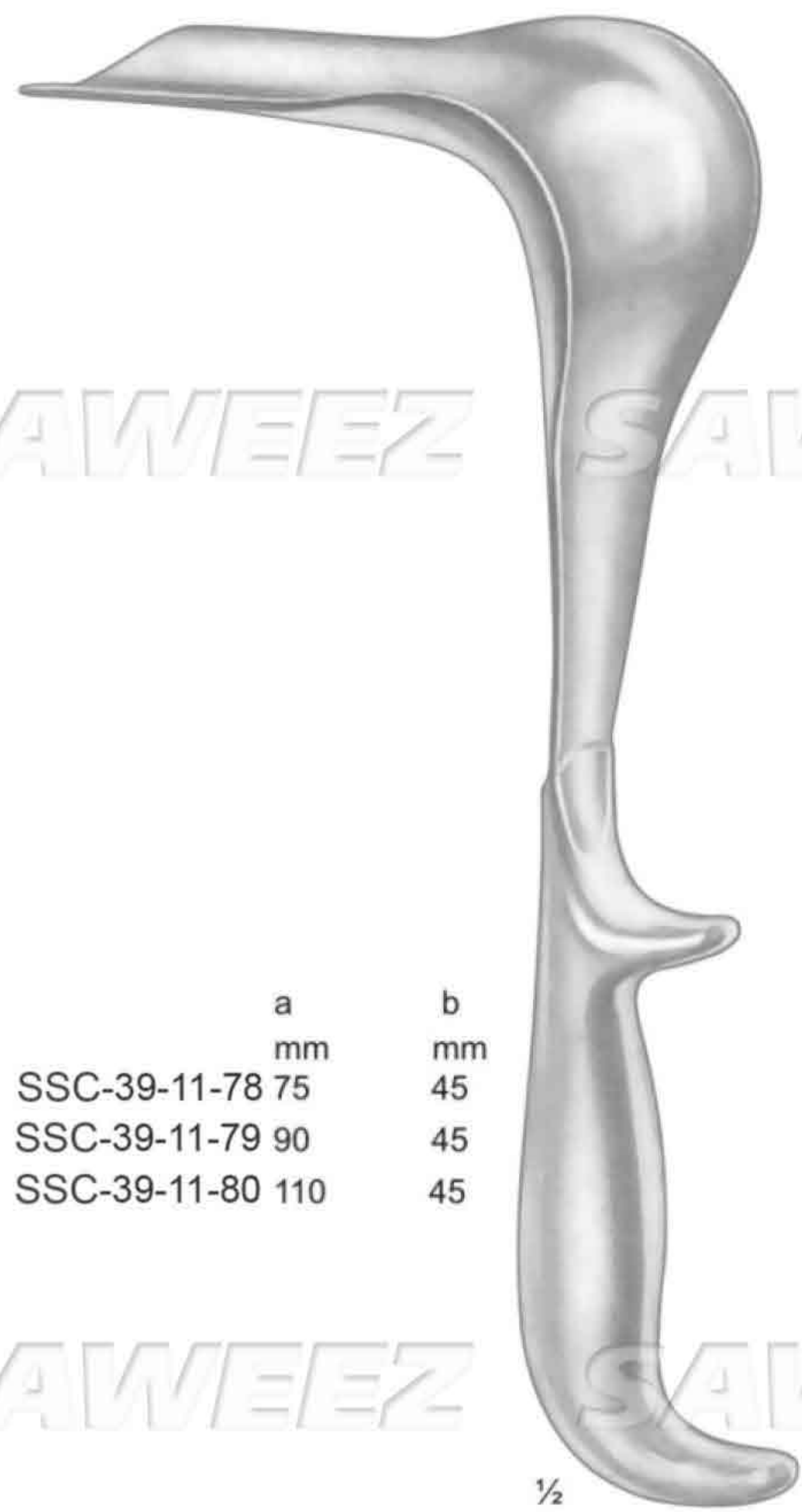
Fig.	slightly-concave a mm	b mm
1	SSC-39-11-67 55	35
2	SSC-39-11-68 58	35
3	SSC-39-11-69 115	35
1	SSC-39-11-70 55	45
2	SSC-39-11-71 85	45
3	SSC-39-11-72 115	45
4	SSC-39-11-73 160	45
1	SSC-39-11-74 55	60
2	SSC-39-11-75 85	60
3	SSC-39-11-76 115	60
4	SSC-39-11-77 160	60



1/2

Doyen

Fig.	a mm	b mm
1	SSC-39-11-78 75	45
2	SSC-39-11-79 90	45
3	SSC-39-11-80 110	45



1/2

Doyen

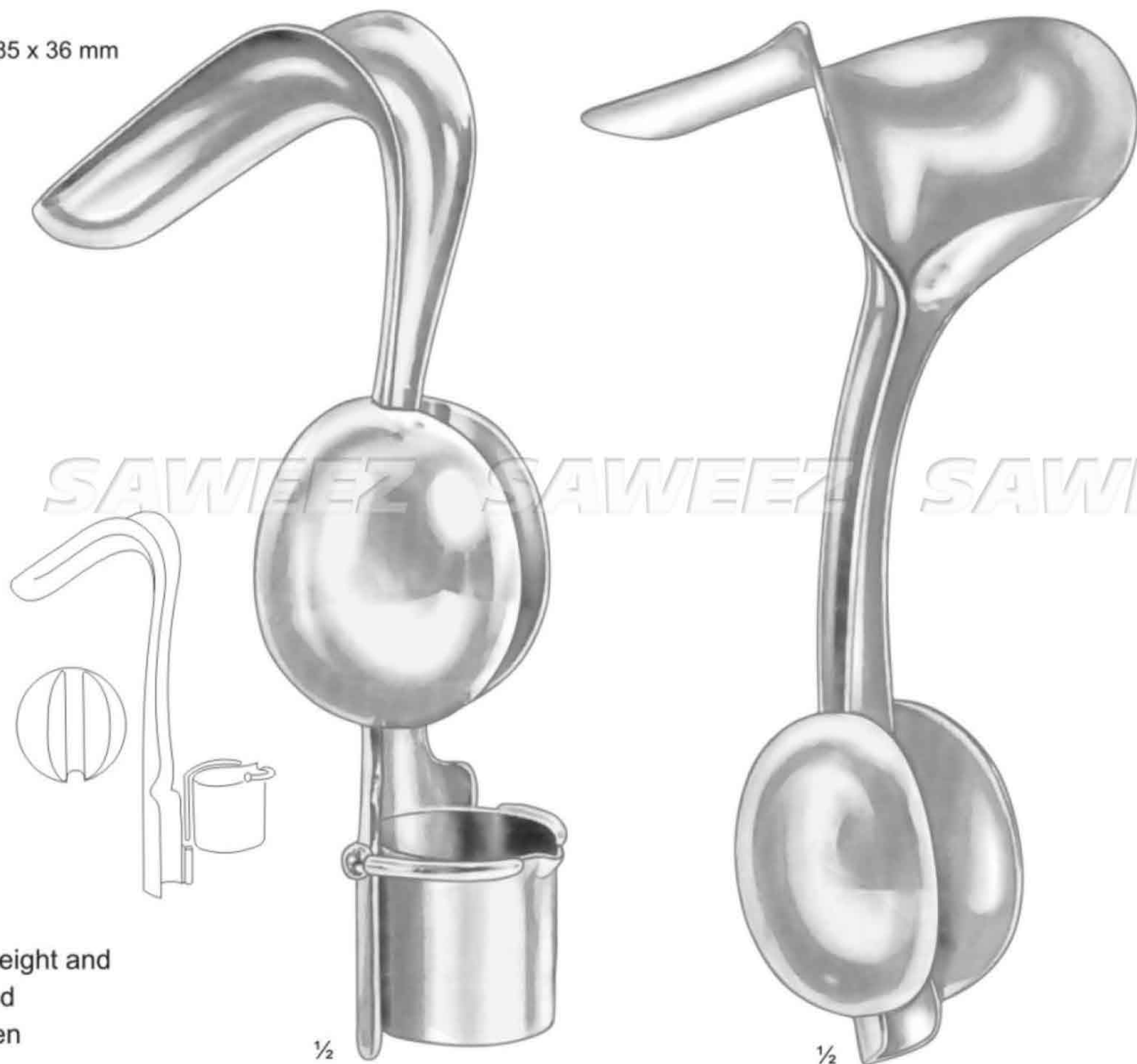
SAWEEZ SAWEEZ SAWEEZ SAWEEZ



SAWEEZ SAWEEZ SAWEEZ SAWEEZ

85 x 36 mm

80 x 38 mm



Samuel
SSC-39-11-81
complete, with removable weight and metal strainer with perforated bottom for retaining specimen

1/2

Samuel

1/2

Auvard
SSC-39-11-83

complete, with removable weight

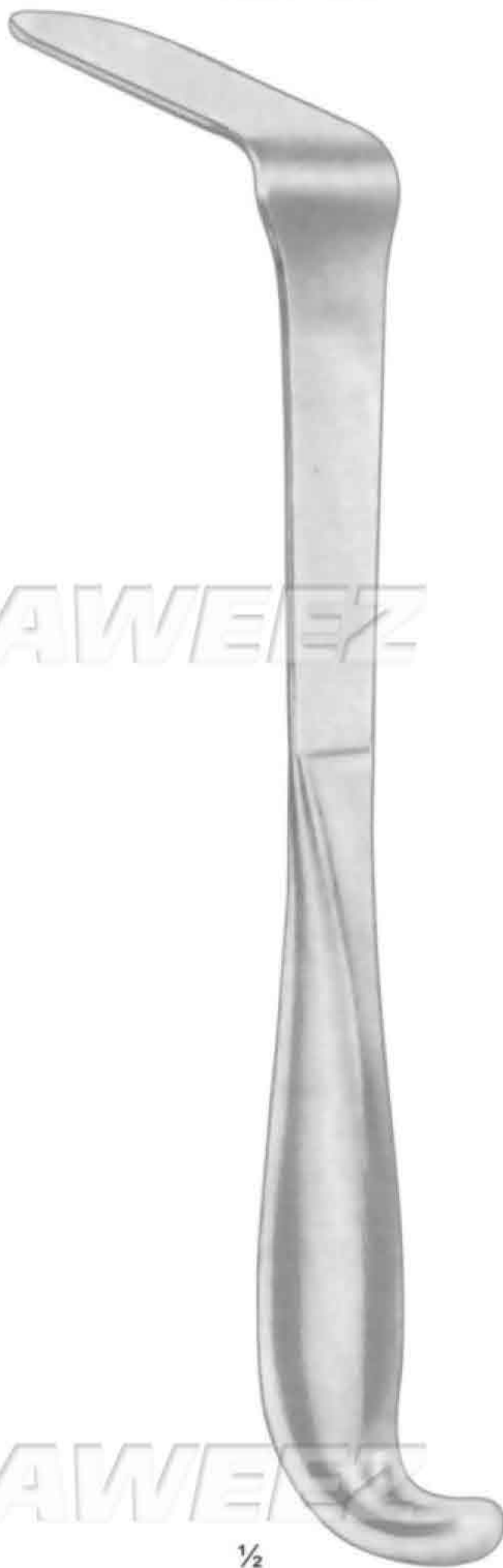
SAWEEZ SAWEEZ SAWEEZ SAWEEZ

Samuel
SSC-39-11-82
metal strainer with perforated bottom only



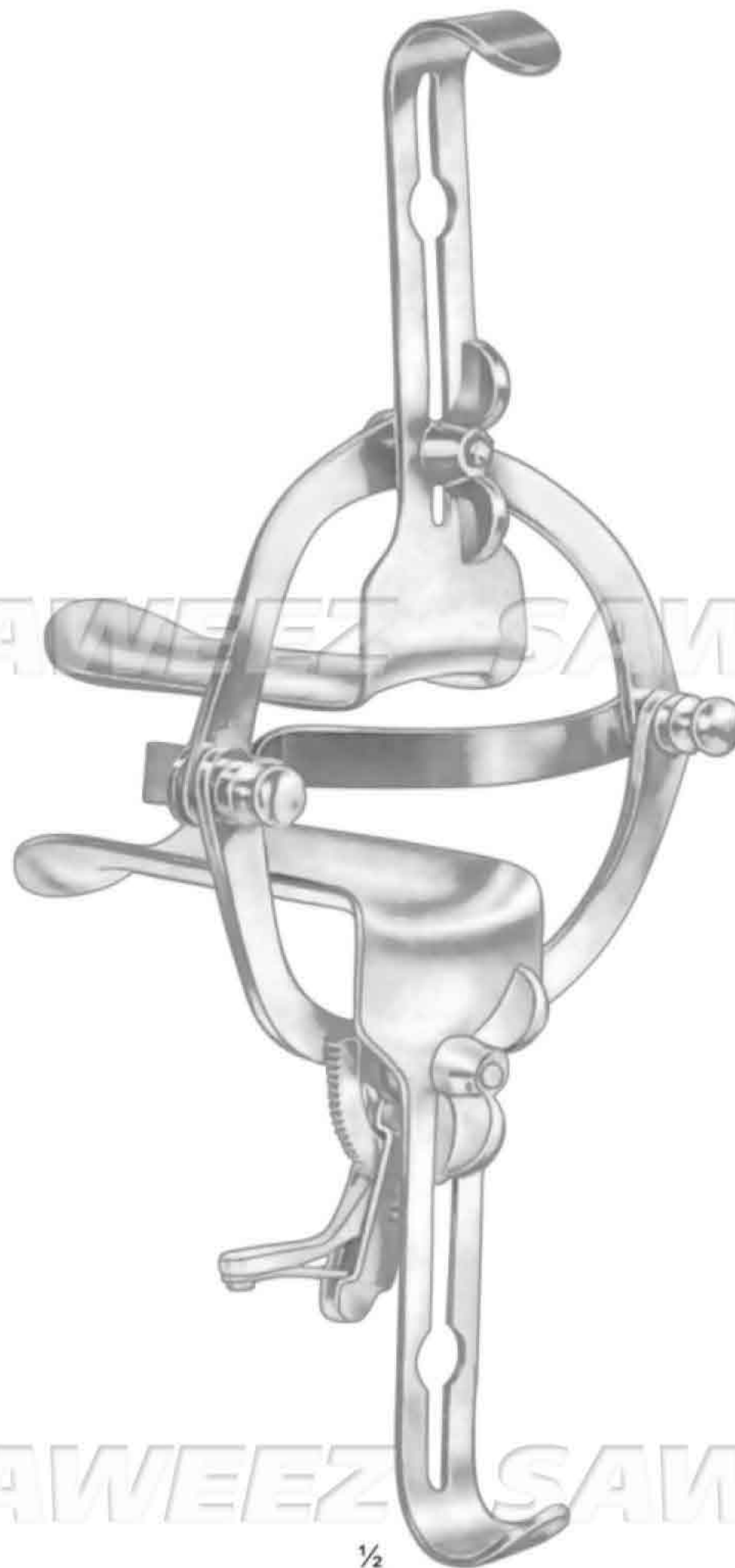
SAWEEZ SAWEEZ SAWEEZ SAWEEZ

70 x 30 mm



1/2

Doyen Vaginal Speculum
SSC-39-11-84
24.0 cm / 9 1/2"



1/2

O'Sullivan-O'Connor
SSC-39-11-85

Vaginal Speculum, for examination and operative work, self-retaining, with adjustable frame, Loktite ratchet, 2 mobile lateral blades and interchangeable blades fig. 1-3.

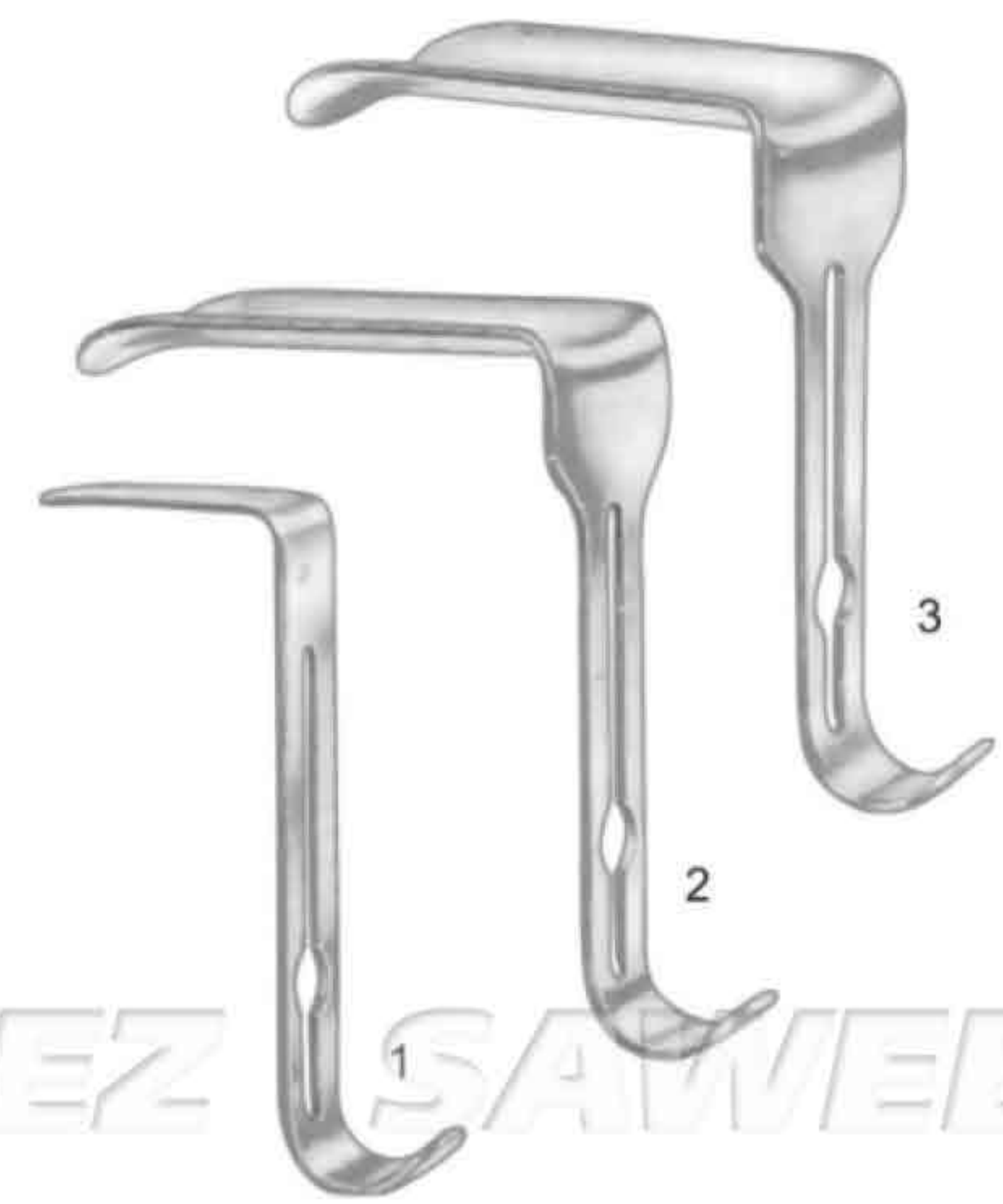


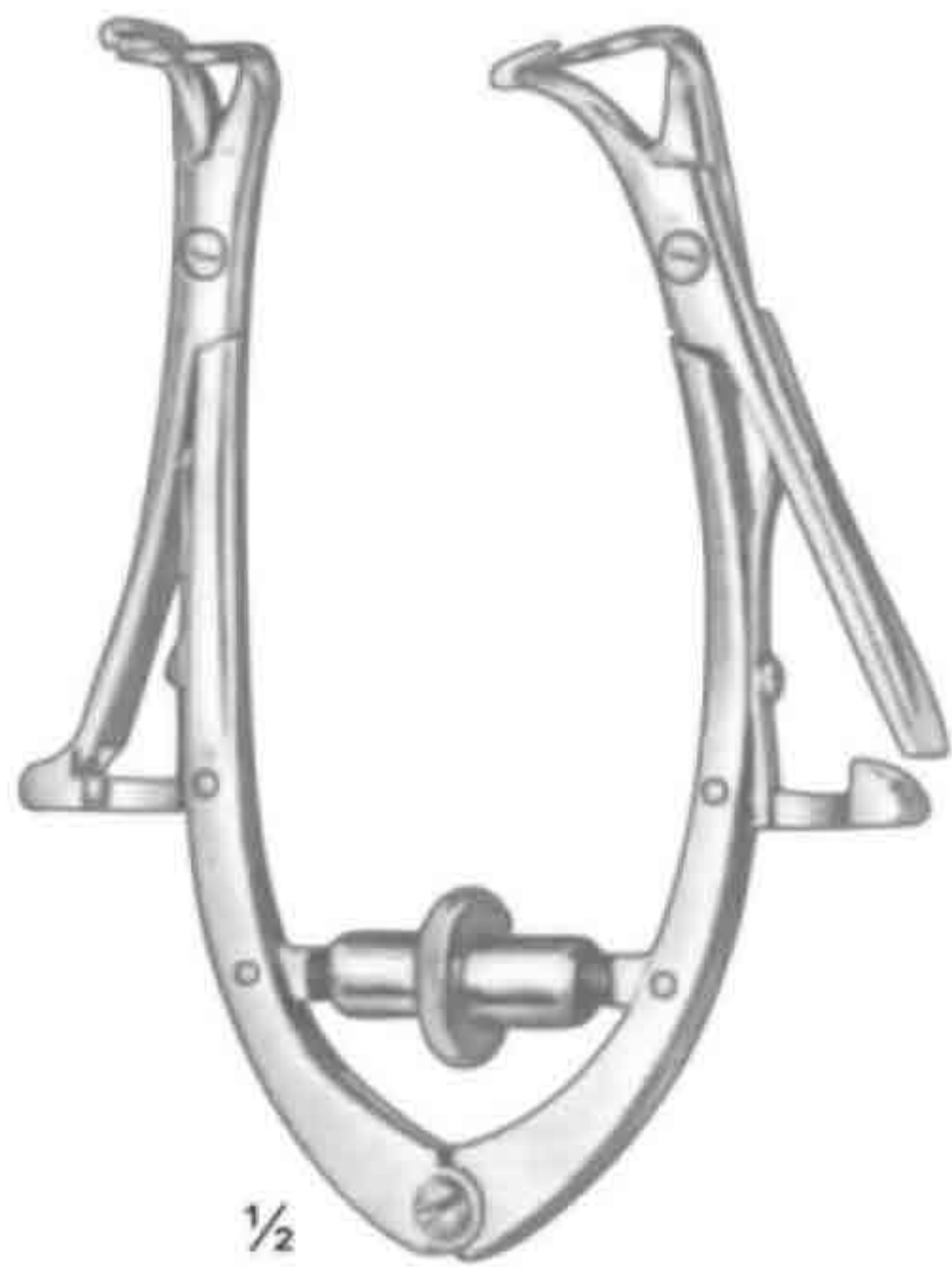
Fig. 1 = 45 x 17 mm
Fig. 2 = 90 x 37 mm
Fig. 3 = 90 x 45 mm

SAWEEZ SAWEEZ SAWEEZ SAWEEZ



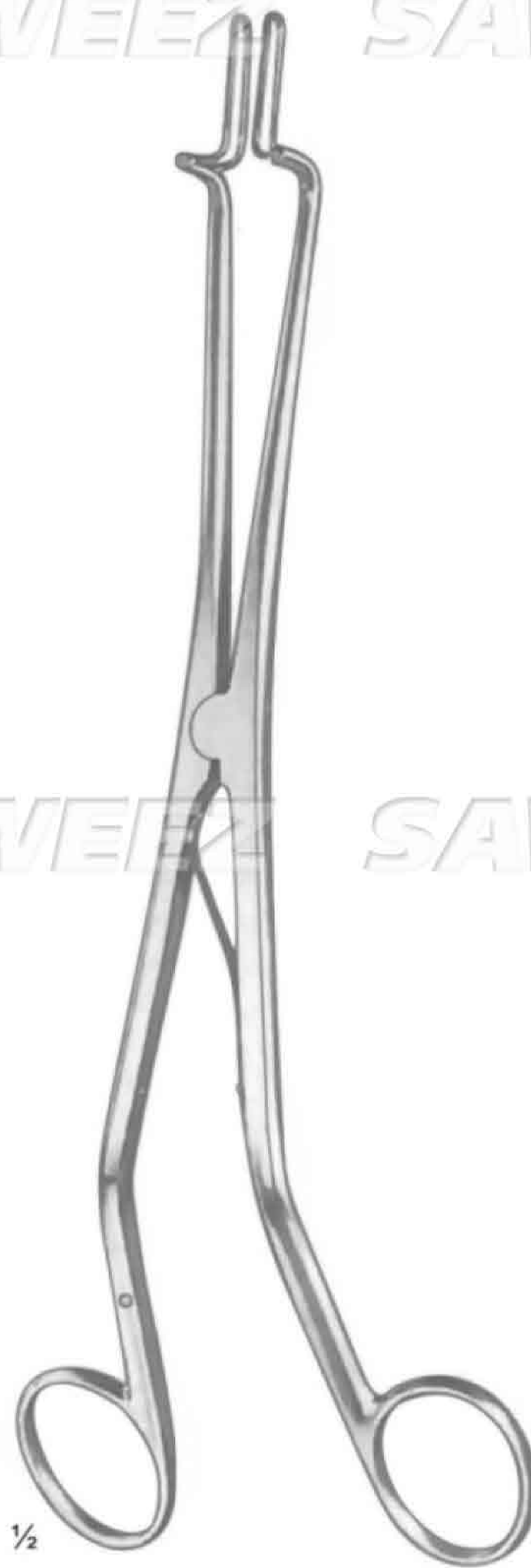
SAWEEZ SAWEEZ SAWEEZ SAWEEZ

SAWEEZ SAWEEZ SAWEEZ SAWEEZ



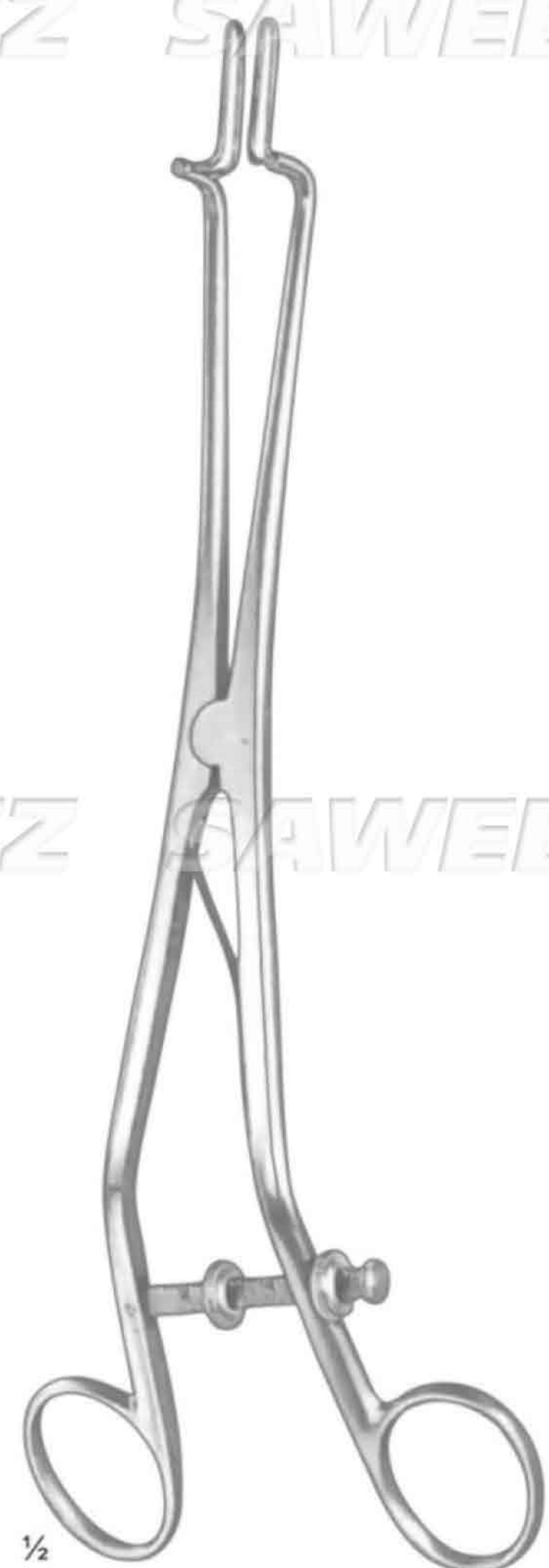
Friedman
SSC-39-11-86
10.0 cm / 4"

Retractor, self-retaining, for perineorhaphy



Kogan
SSC-39-11-87
24.0 cm / 9½"

without ratchet



Kogan
SSC-39-11-88
24.0 cm / 9½"

with scale-ratchet and fixing screws



SAWEEZ SAWEEZ SAWEEZ SAWEEZ



SAWEEZ SAWEEZ SAWEEZ SAWEEZ

SAWEEZ SAWEEZ^{1/2} SAWEEZ SAWEEZ

Pieces per set

14	4.0-17.0	SSC-39-11-89
26	1.0-26.0	SSC-39-11-90



SSC-39-11-91
set of 14 dilators
(4.0-17.0 mm ø), in metal case with hinged lid

SSC-39-11-92
set of 26 dilators
(1.0-26.0 mm ø), in metal case with hinged lid



1/2



1/2

SSC-39-11-93
set of 8 Dilator
(3.0/4.0 - 17.0/18.0 mm ø)

SSC-39-11-94
set of 13 Dilator
(1.0-2.0-25.0/26.0 mm ø)



SSC-39-11-95
set of 8 dilators
(3.0/4.0-17.0/18.0 mm \varnothing ,
in boilable canvas roll



SSC-39-11-96
set of 8 dilators
(3.0/4.0-17.0/18.0 mm \varnothing ,
in metal case with hinged lid



SSC-39-11-97
set of 13 dilators
(1.0/2.0-25.0/26.0 mm \varnothing ,
in metal case with hinged lid



malleable

malleable



1/2

1/2

Sims

SSC-39-11-98
32.0 cm / 12 1/2"

Special Model

SSC-39-11-99
32.0 cm / 12 1/2"

Strong pattern



1/2

1/2

1/2

Staude-Moore
SSC-39-12-00
17.0 cm / 6 3/4"

Barrett
SSC-39-12-01
18.0 cm / 7"

Pozzi
SSC-39-12-02
25.5 cm / 10 1/4"



SAWEEZ SAWEEZ SAWEEZ SAWEEZ



1/2

Schroeder
SSC-39-12-03
25.0 cm / 10"



1/2

Braun
SSC-39-12-04
25.0 cm / 10"



1/2

Duplay
SSC-39-12-05
28.0 cm / 11"

SAWEEZ SAWEEZ SAWEEZ SAWEEZ

Amniotome for the amnion bladder

SAWEEZ SAWEEZ SAWEEZ SAWEEZ



1/2

Beacham
SSC-39-12-06
26.0 cm / 10 1/4"



1/2

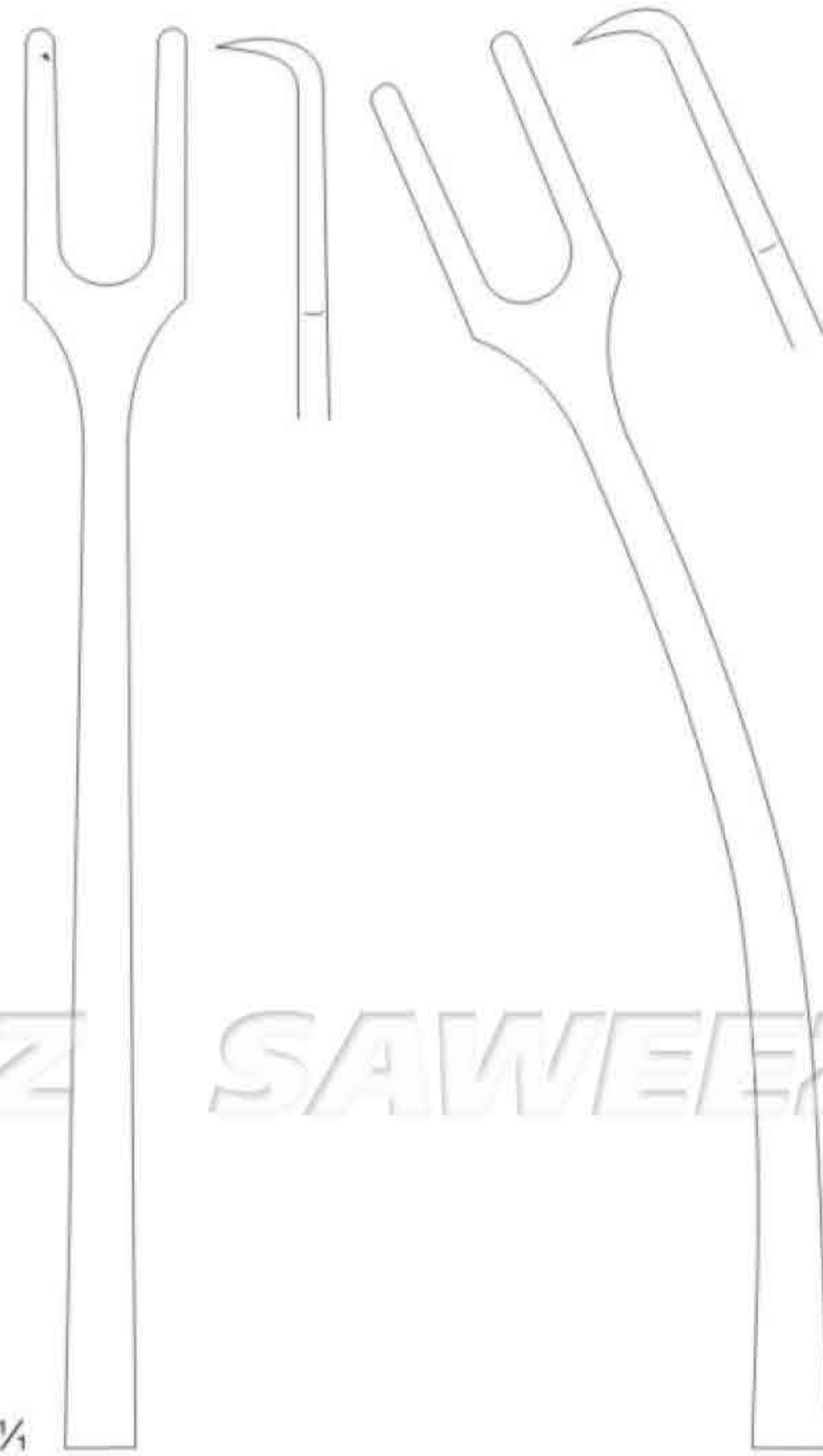
Skene
SSC-39-12-07
24.0 cm / 9 1/4"

SAWEEZ SAWEEZ SAWEEZ SAWEEZ

SAWEEZ SAWEEZ SAWEEZ SAWEEZ



SAWEEZ SAWEEZ SAWEEZ SAWEEZ



SSC-39-12-08

SSC-39-12-09

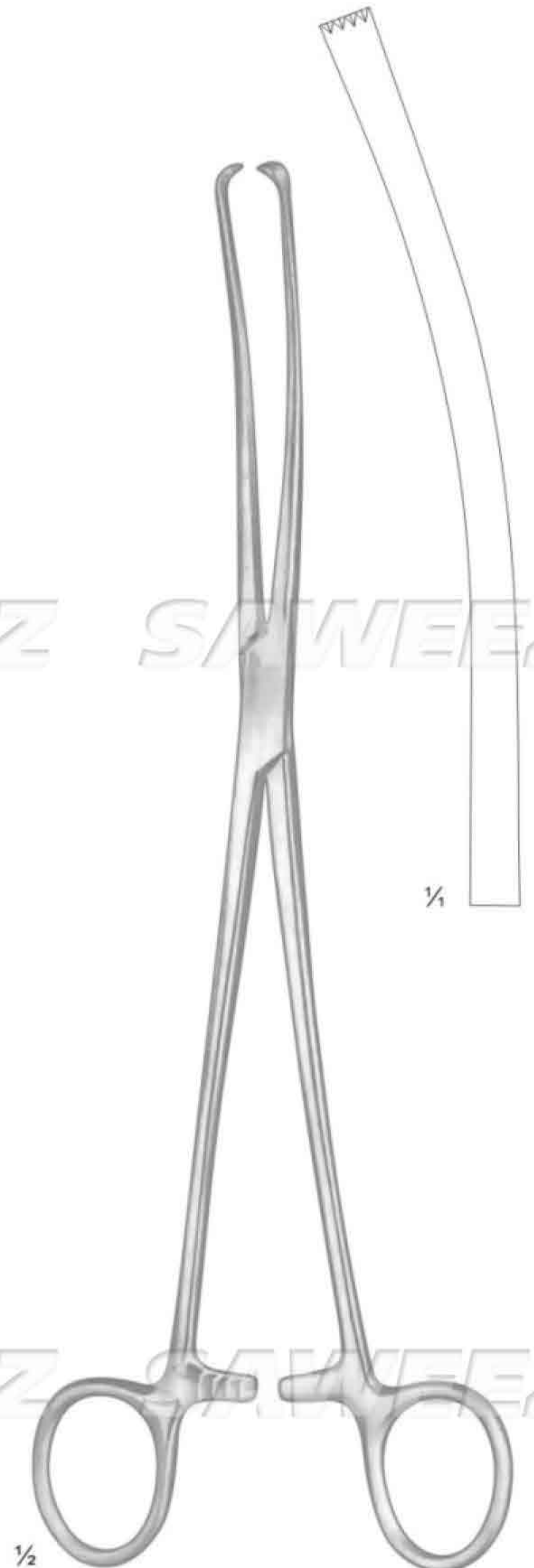
SAWEEZ SAWEEZ SAWEEZ SAWEEZ



Schroeder
24.0 cm / 9½"



Teale
SSC-39-12-10
23.0 cm / 9"



Iowa
SSC-39-12-11
26.0 cm / 10¼"
for the amnion bladder

SAWEEZ SAWEEZ SAWEEZ SAWEEZ



SAWEEZ SAWEEZ SAWEEZ SAWEEZ



SAWEEZ SAWEEZ SAWEEZ SAWEEZ

SAWEEZ SAWEEZ SAWEEZ SAWEEZ

½

Museux
24.0 cm / 9½"

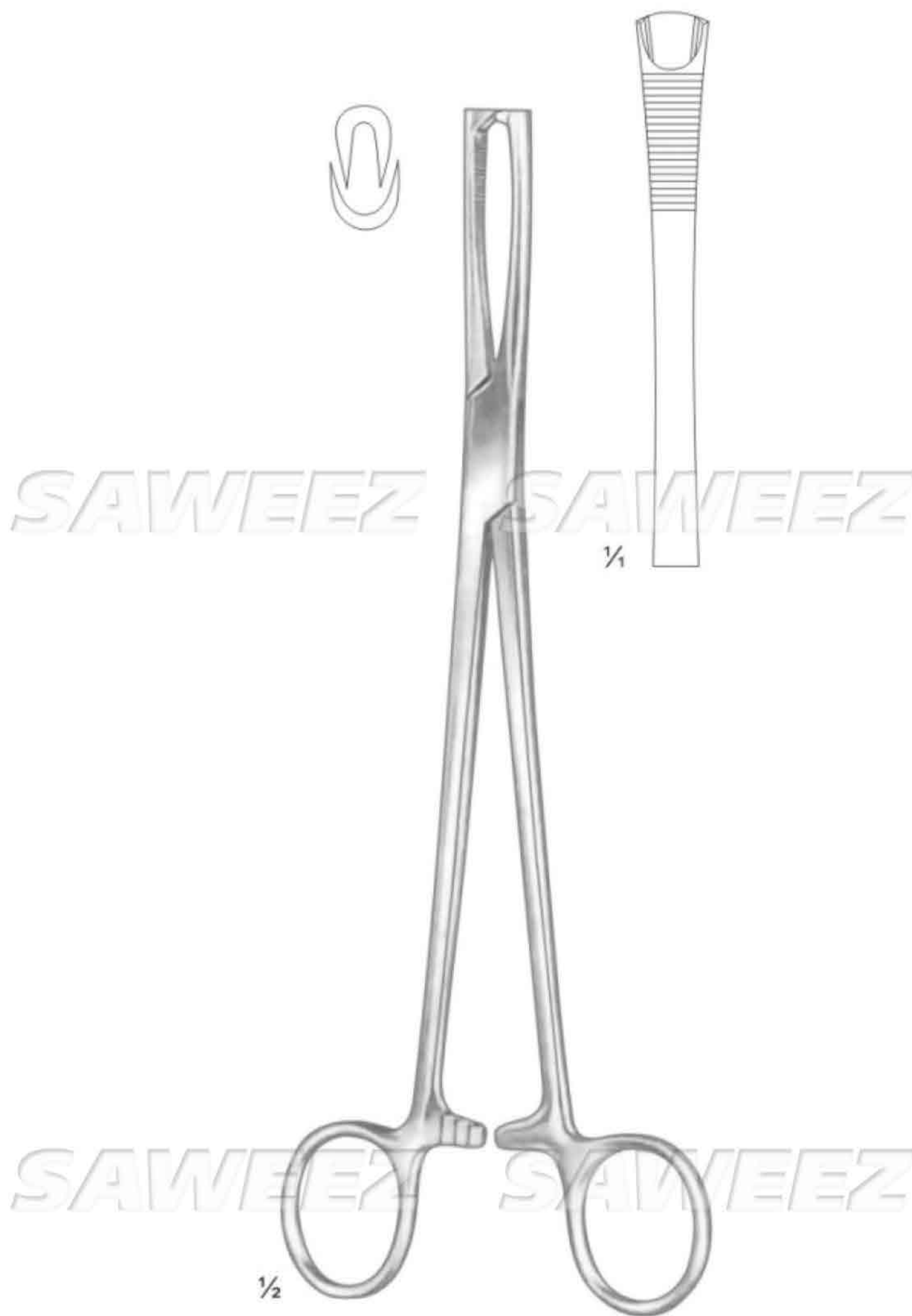
½

Museux
24.0 cm / 9½"

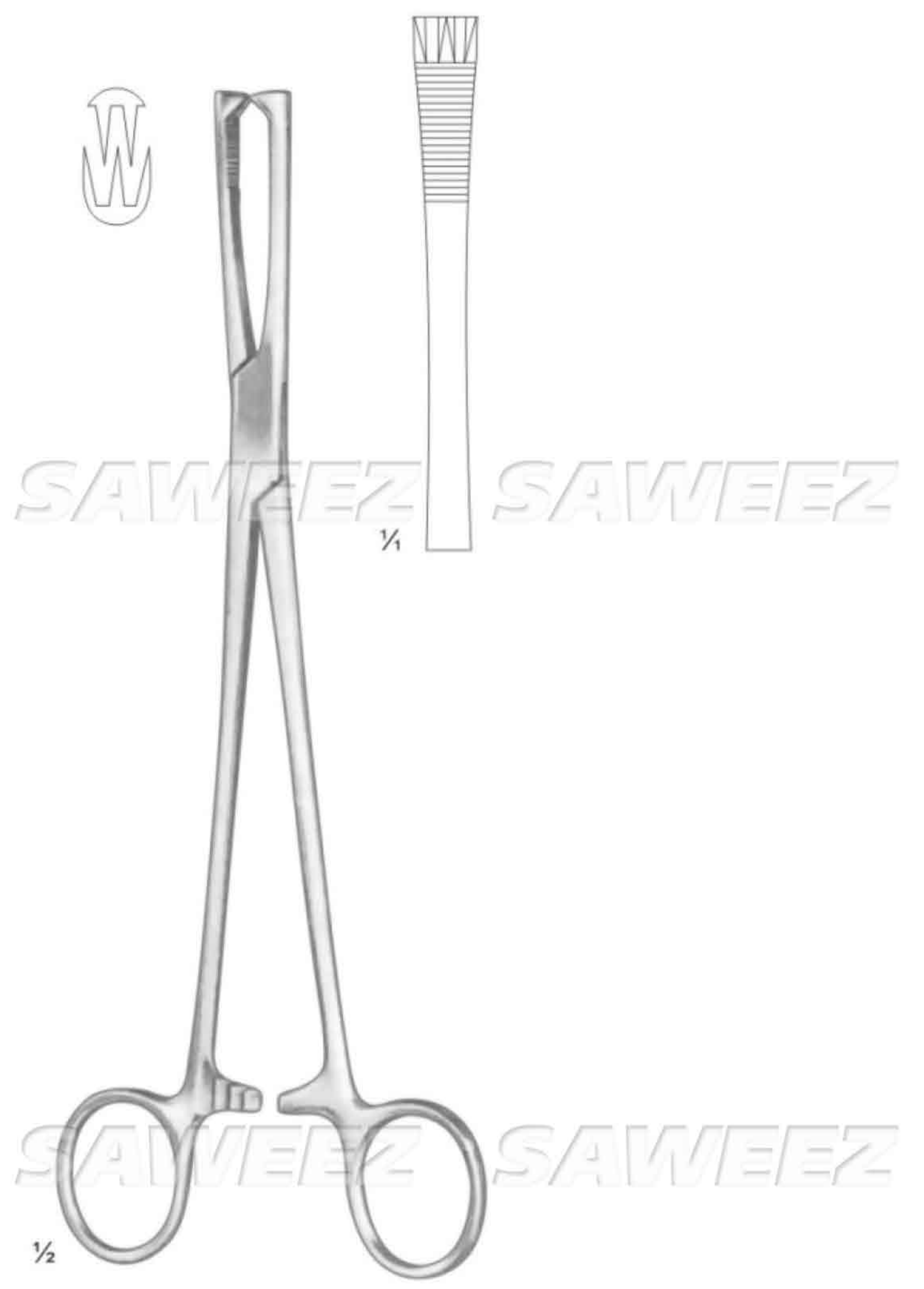
curved sideways



SAWEEZ SAWEEZ SAWEEZ SAWEEZ



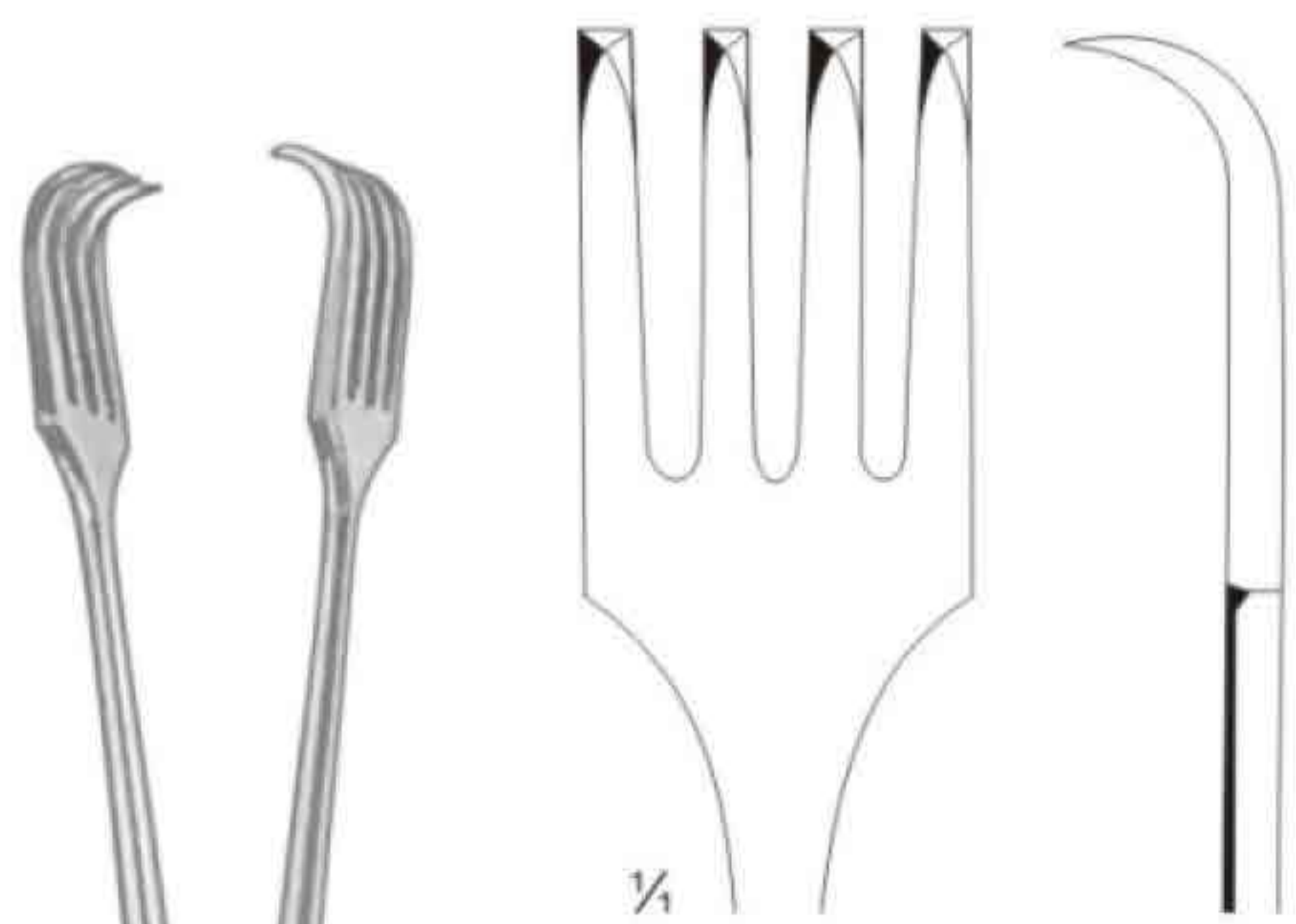
Jacobs
 SSC-39-12-17
 21.0 cm / 8 1/4"



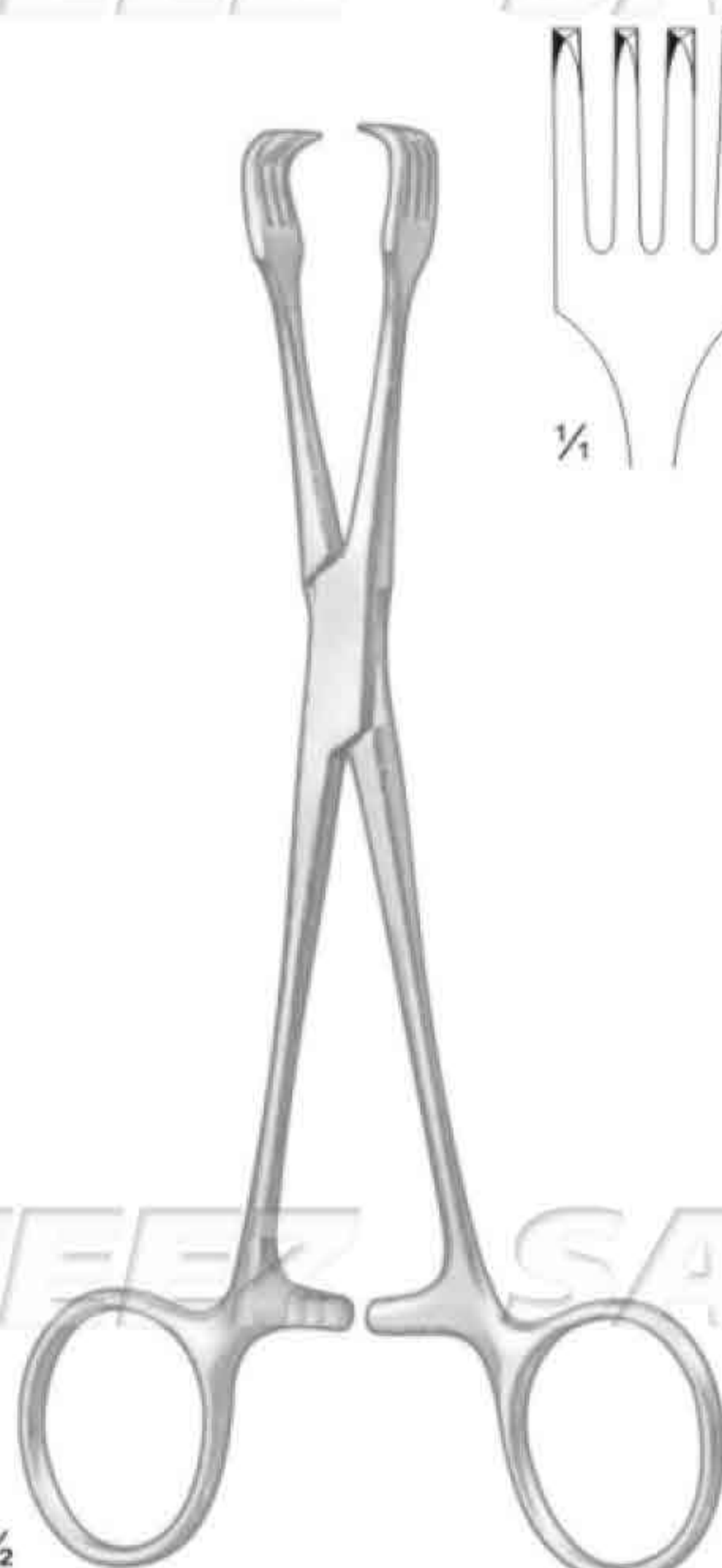
Henrotin
 SSC-39-12-18
 20.5 cm / 8"



SAWEEZ SAWEEZ SAWEEZ SAWEEZ



SAWEEZ SAWEEZ SAWEEZ SAWEEZ



SSC-39-12-19
26.0 cm / 10 1/4"

Braun
SSC-39-12-20
16.0 cm / 6 1/4"

Czerny
SSC-39-12-21
21.0 cm / 8 1/4"



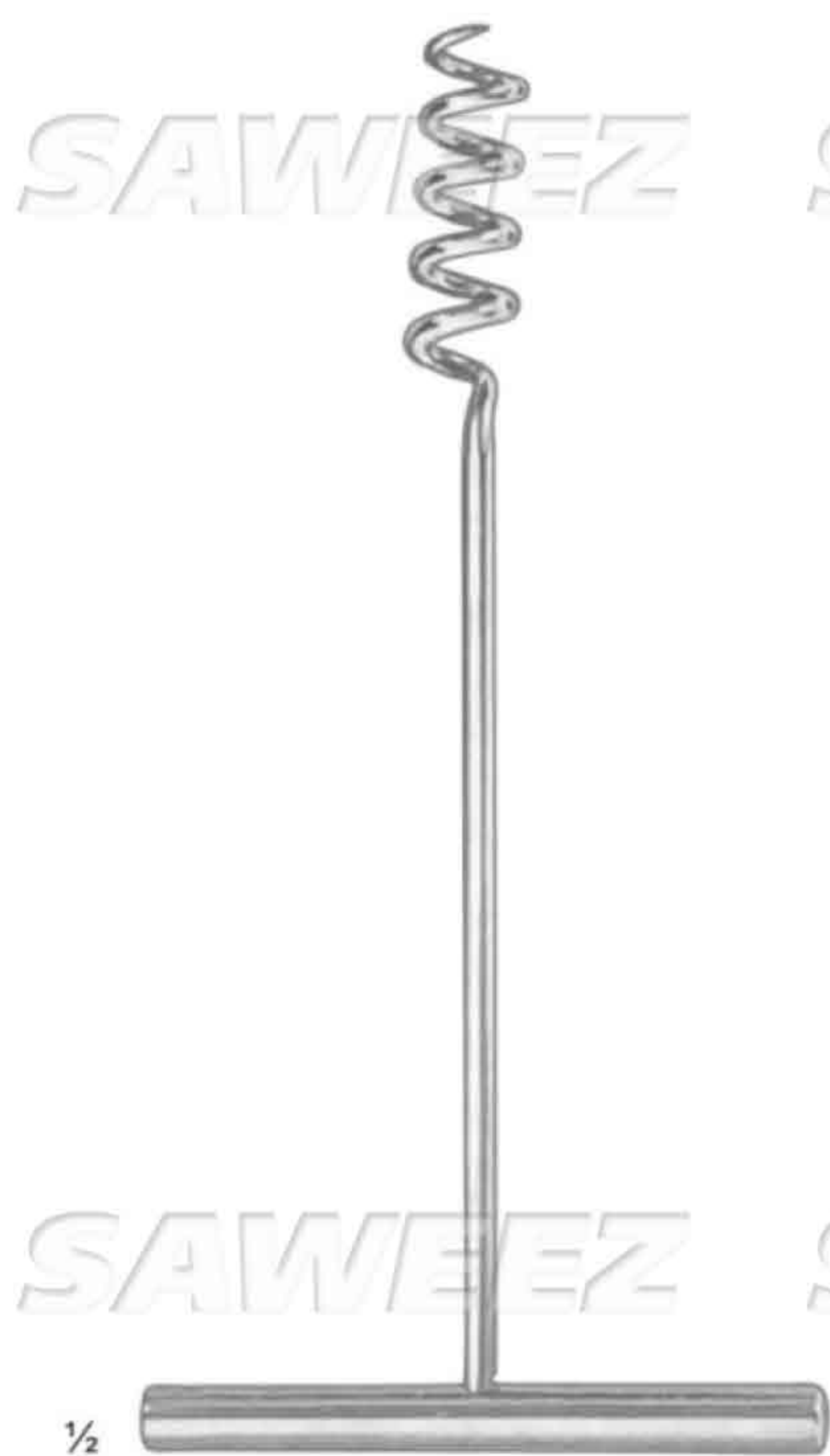
Kelly
 SSC-39-12-22
 32.0 cm / 12½"

Noto
 SSC-39-12-23
 27.0 cm / 10½"

Doyen
 SSC-39-12-24
 20.0 cm / 8"



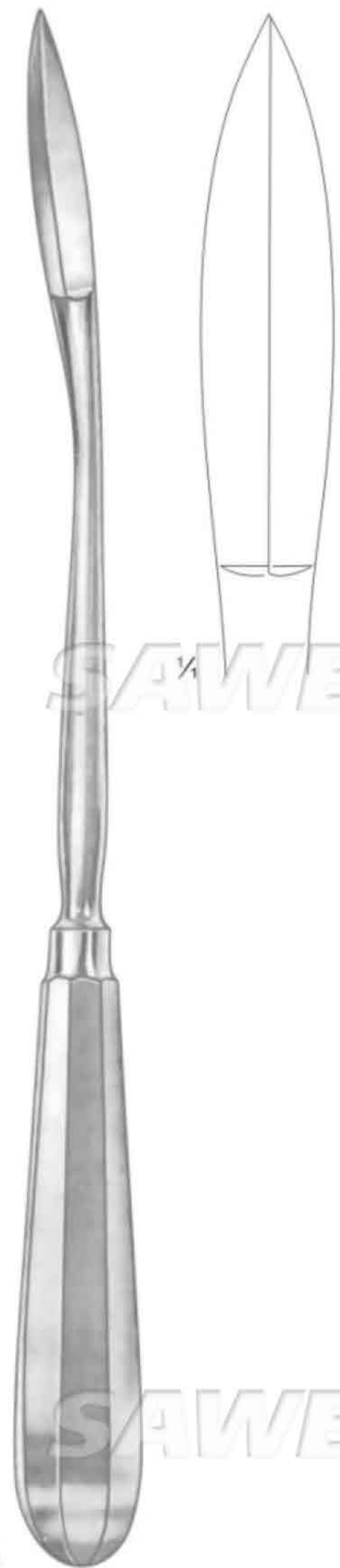
SAWEEZ SAWEEZ SAWEEZ SAWEEZ



Doyen
SSC-39-12-25
17.0 cm / 6¾"



Doyen
SSC-39-12-26
17.0 cm / 6¾"



Segond
SSC-39-12-27

SAWEEZ SAWEEZ SAWEEZ SAWEEZ



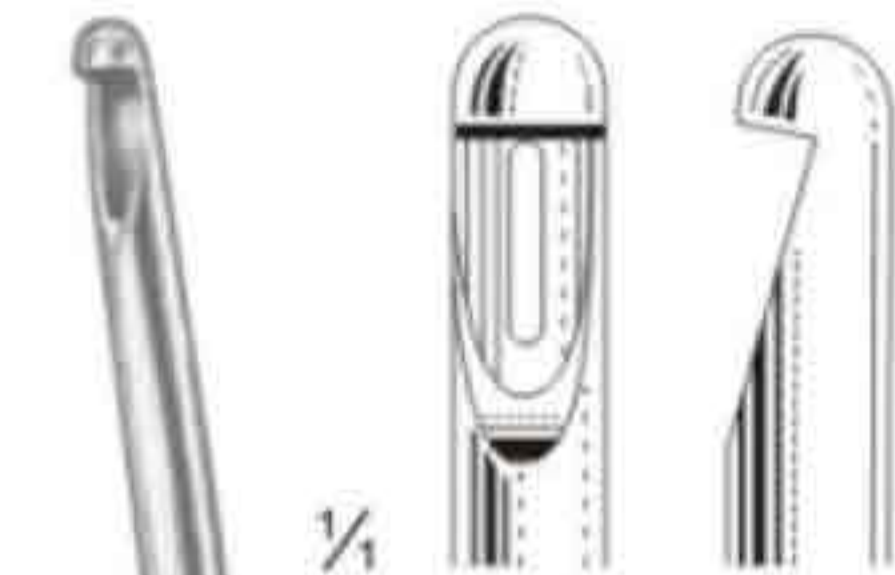
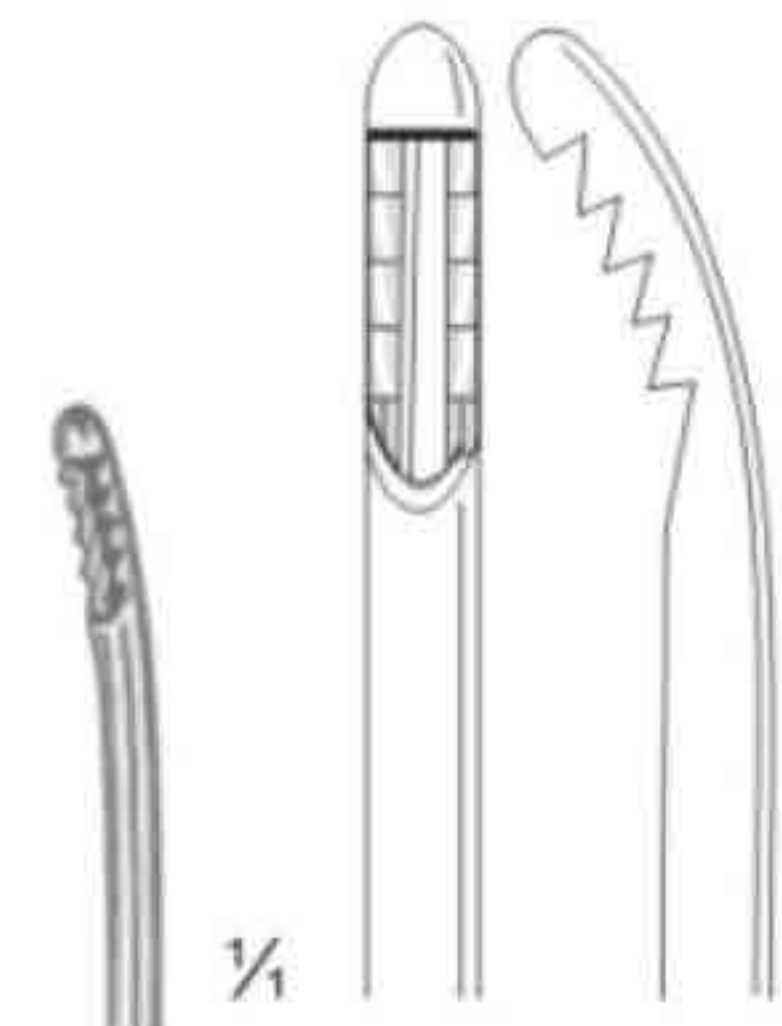
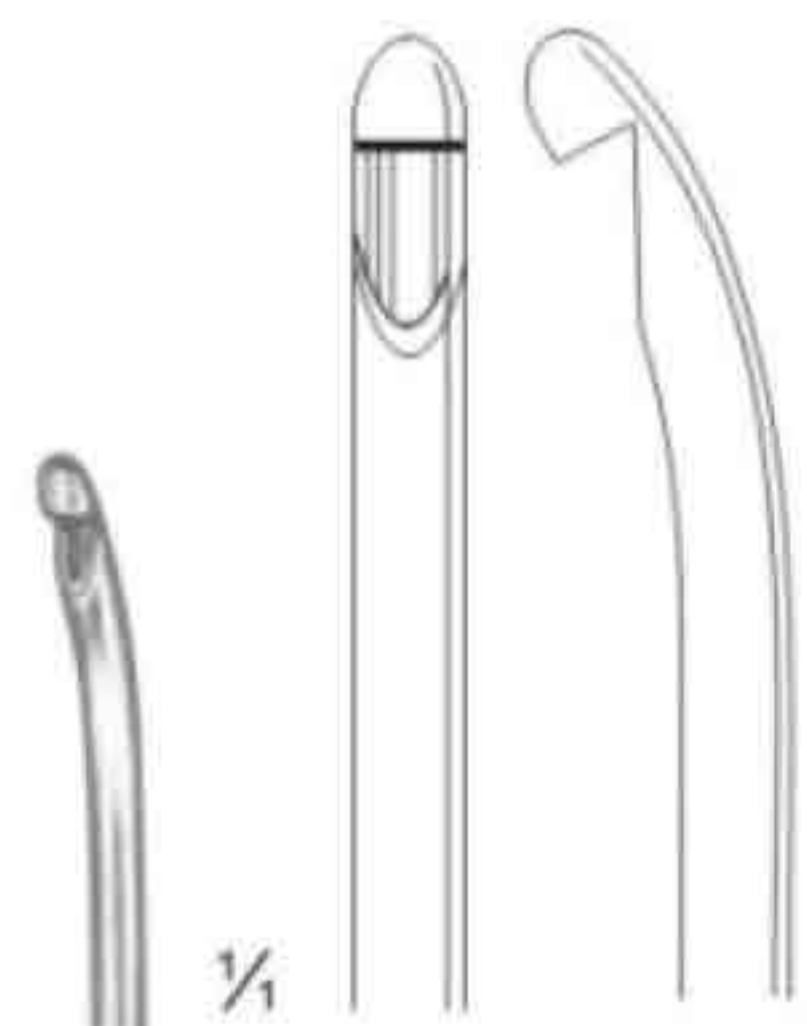
Dartingues
SSC-39-12-28
27.0 cm / 10½"

Somer
SSC-39-12-29
23.0 cm / 9"

Collin
SSC-39-12-30
25.0 cm / 10"



SAWEEZ SAWEEZ SAWEEZ SAWEEZ



SAWEEZ SAWEEZ SAWEEZ SAWEEZ



SAWEEZ SAWEEZ SAWEEZ SAWEEZ

Randall
SSC-39-12-31
24.0 cm / 9½"
4 mm ø

Novak
SSC-39-12-32
23.0 cm / 9"
4 mm ø

Kevorkian
SSC-39-12-33
30.0 cm / 12"

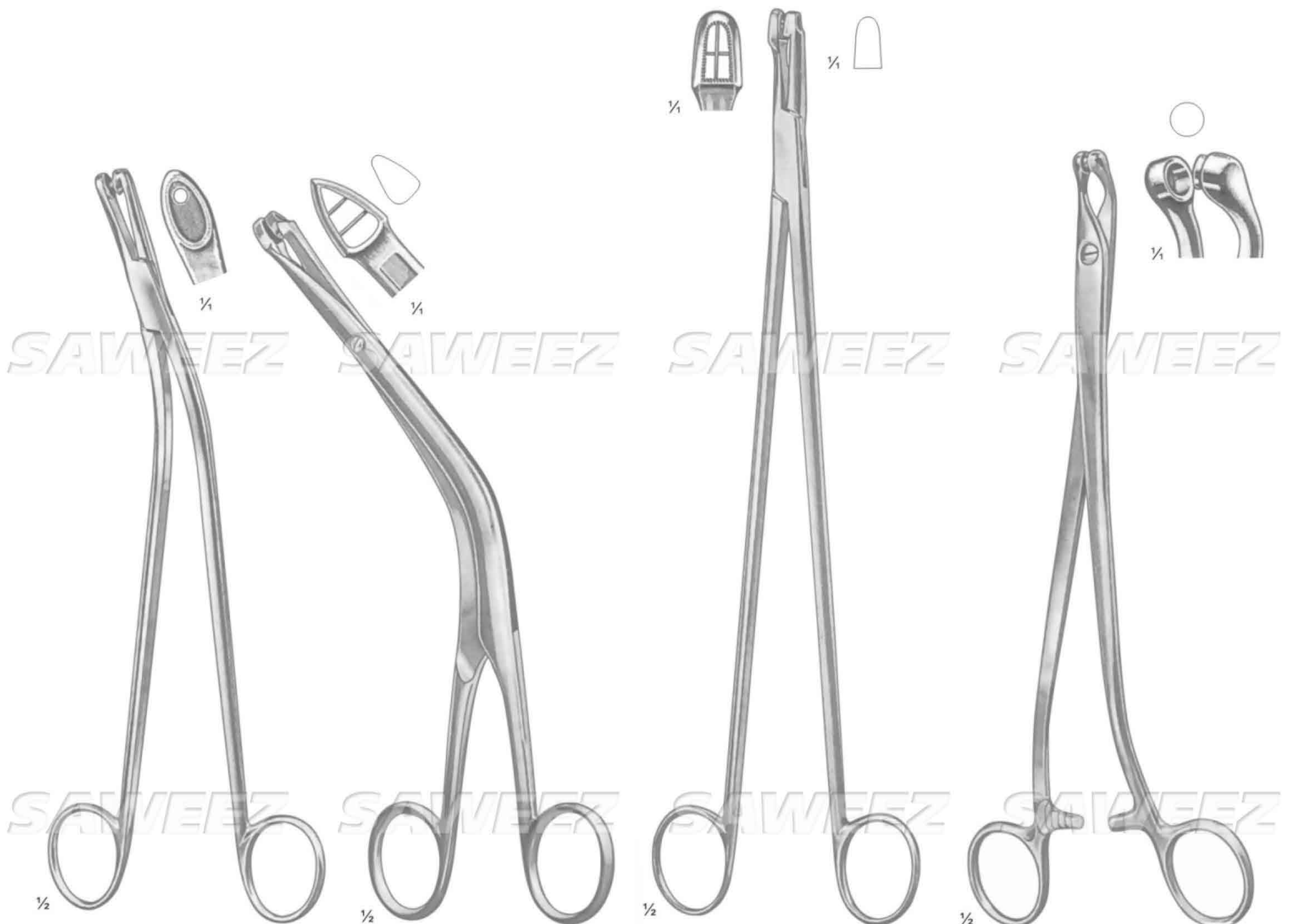
Mod. Muenchen
SSC-39-12-34
27.0 cm / 10½"

Biopsy Curettes

Endometrial Suction Biopsy Curettes



SAWEEZ SAWEEZ SAWEEZ SAWEEZ



Gellhorn
 SSC-39-12-35
 23.0 cm / 9"

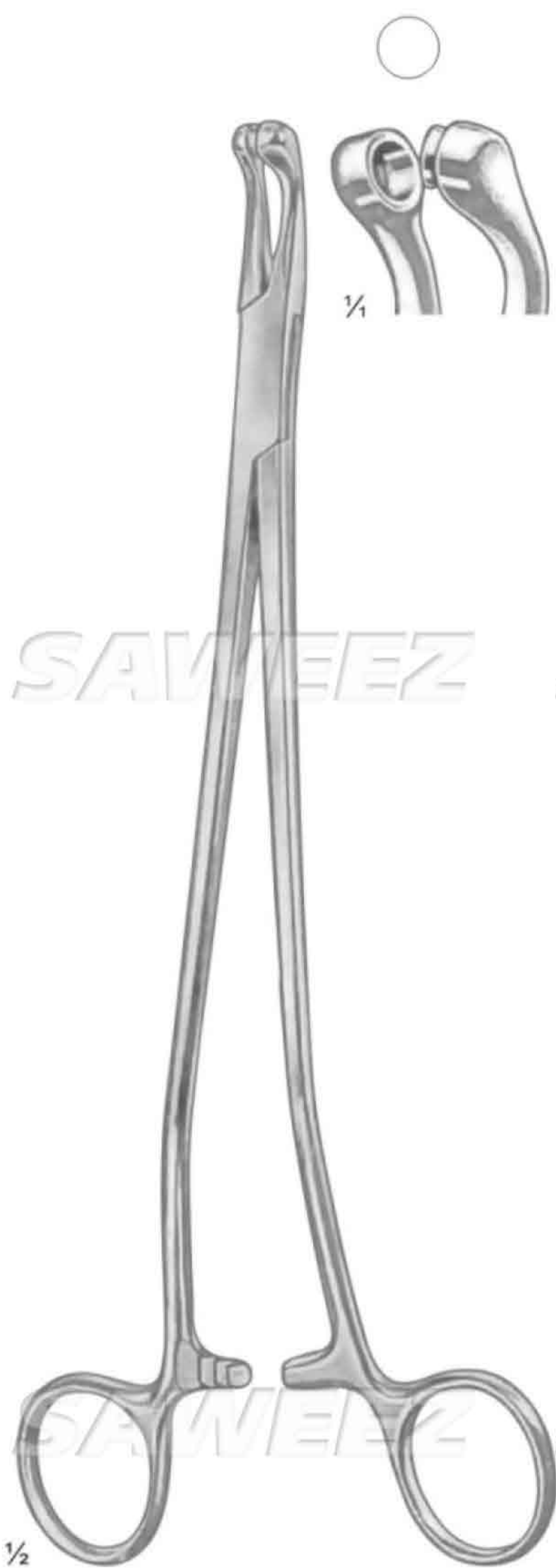
Faure
 SSC-39-12-36
 21.0 cm / 8¼"

Schubert
 SSC-39-12-37- 21.0 cm / 8¼"
 SSC-39-12-38- 29.0 cm / 11½"

Thoms-Gaylor
 SSC-39-12-39
 24.0 cm / 9½"



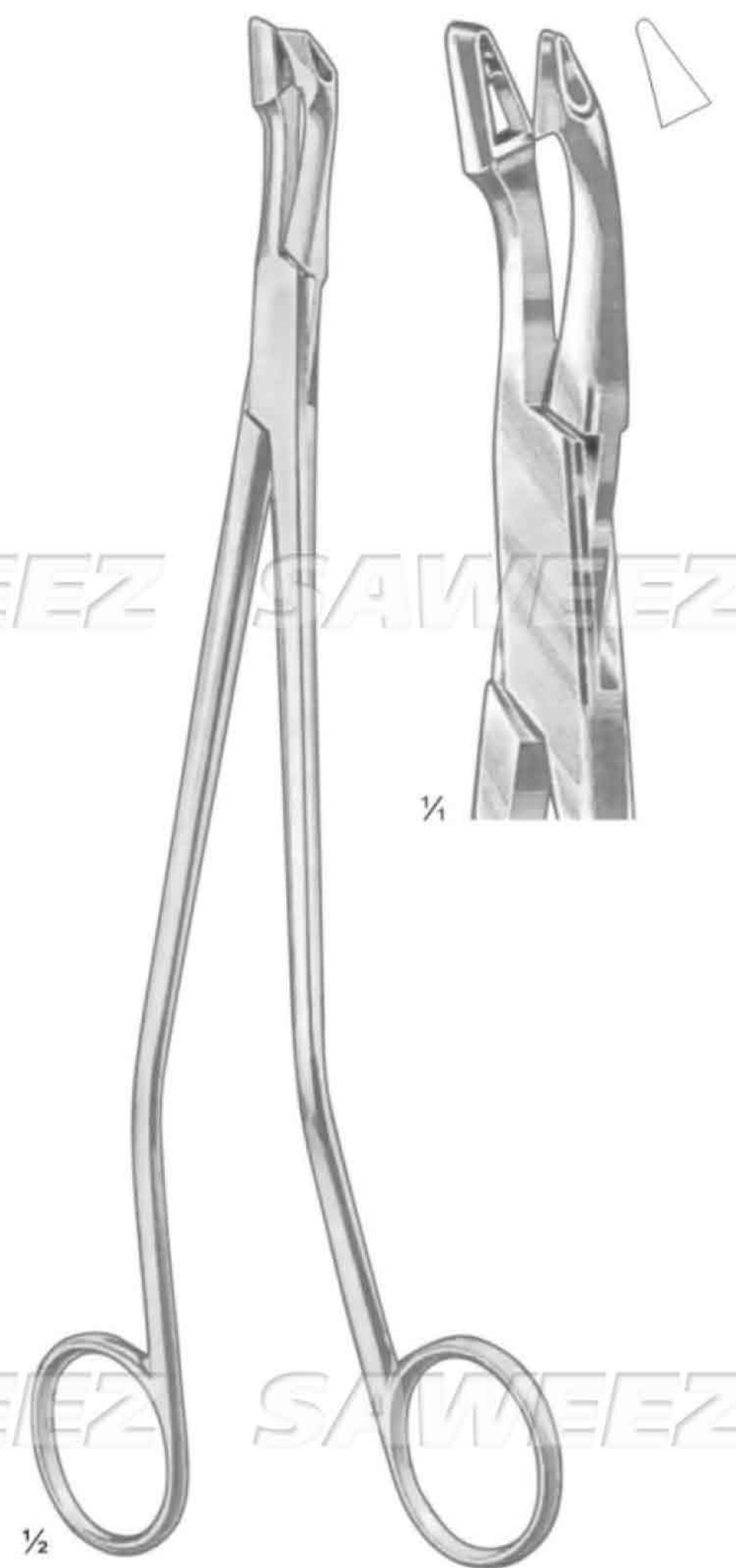
SAWEEZ SAWEEZ SAWEEZ SAWEEZ



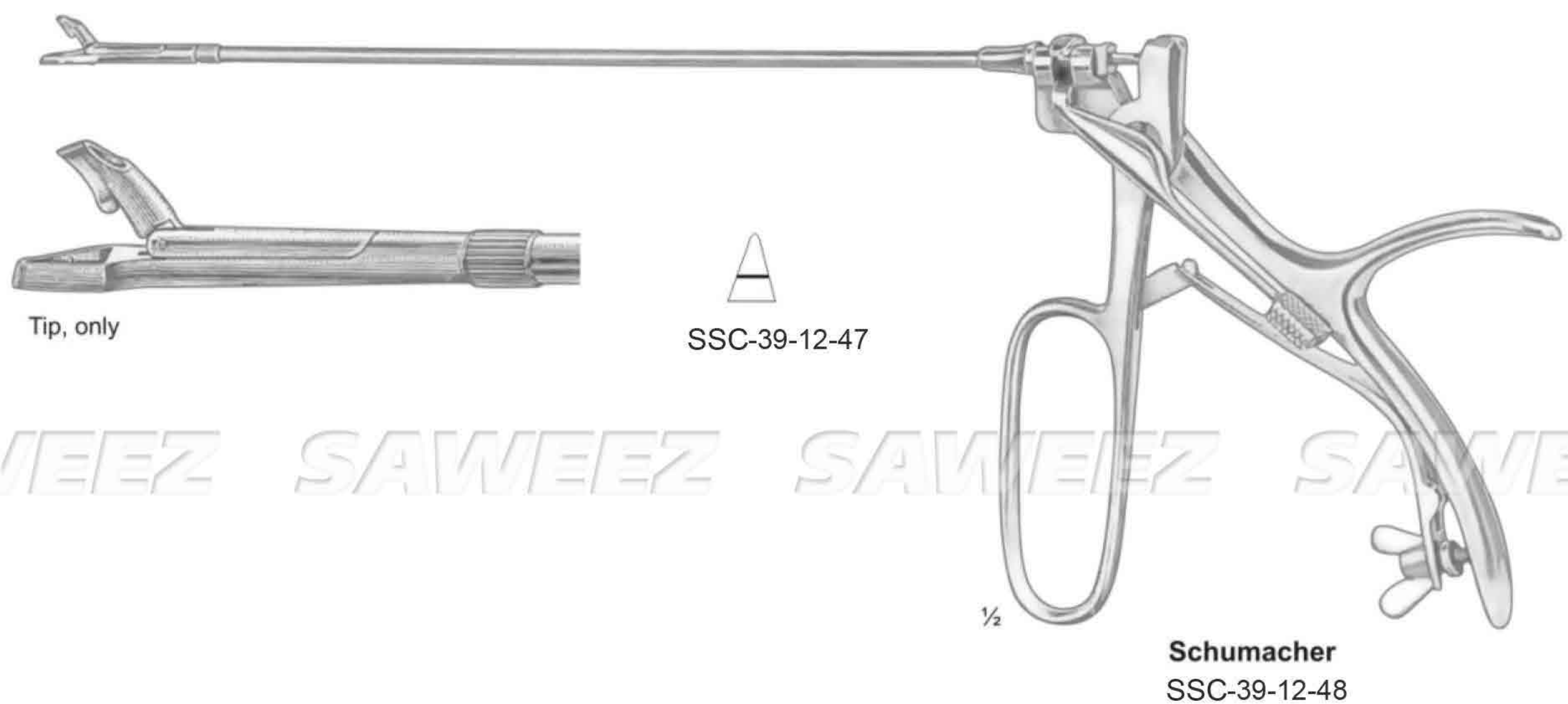
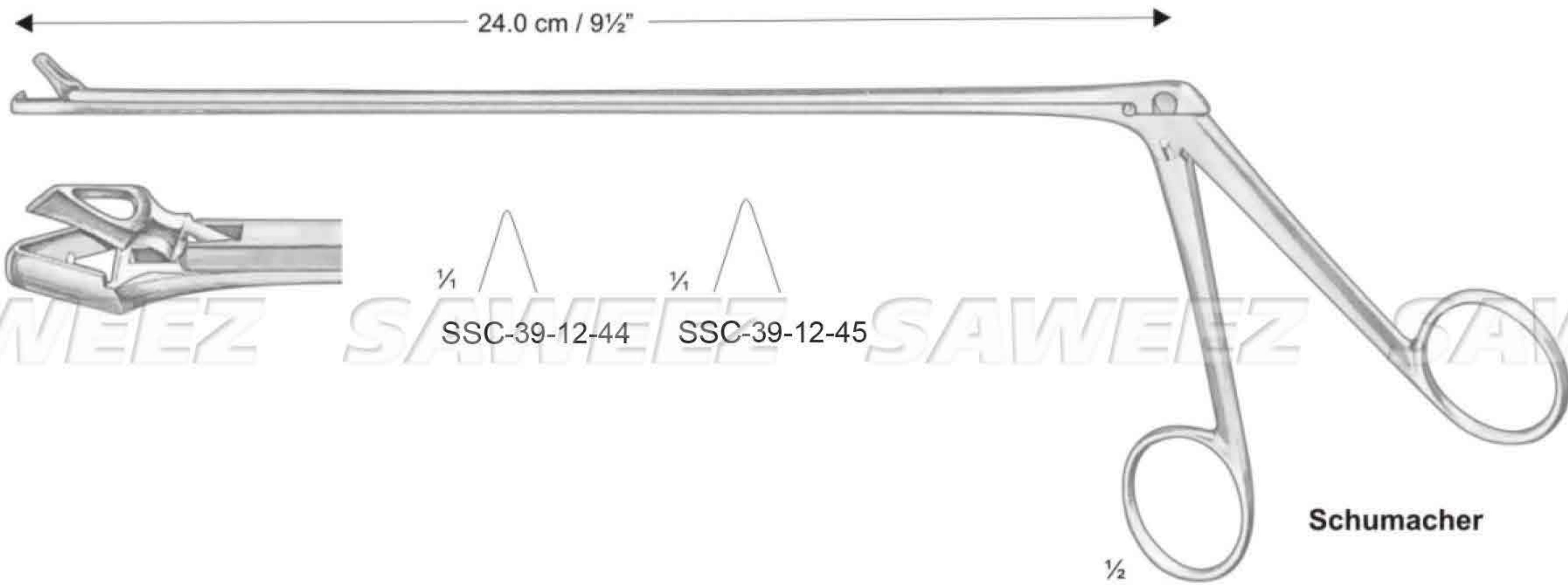
Thoms-Gaylor
SSC-39-12-40 - 22.0 cm / 8½"
SSC-39-12-41 - 24.0 cm / 9½"



Schubert
SSC-39-12-42
26.0 cm / 10¼"



Van Doren
SSC-39-12-43
24.0 cm / 9½"





SSC-39-12-49



SSC-39-12-55



SSC-39-12-50



SSC-39-12-56



SSC-39-12-51



SSC-39-12-57



SSC-39-12-52



SSC-39-12-58



SSC-39-12-53



SSC-39-12-59



SSC-39-12-54



SSC-39-12-60



1/2

Simon
25.0 cm / 10"

sharp, rigid



1/2

Schroeder
30.0 cm / 12"

sharp, rigid



Sharp

Blunt



Recamier-Sims-Bumm
SSC-39-12-61
31.0 cm / 12½"
Fig. 00-16
rigid

Recamier-Sims-Bumm
SSC-39-12-62
31.0 cm / 12½"
Fig. 00-16
malleable

Recamier-Sims-Bumm
SSC-39-12-63
31.0 cm / 12½"
Fig. 00-16
rigid

Recamier-Sims-Bumm
SSC-39-12-64
31.0 cm / 12½"
Fig. 00-16
rigid



Sharp Curettes
(Recamier Handle)



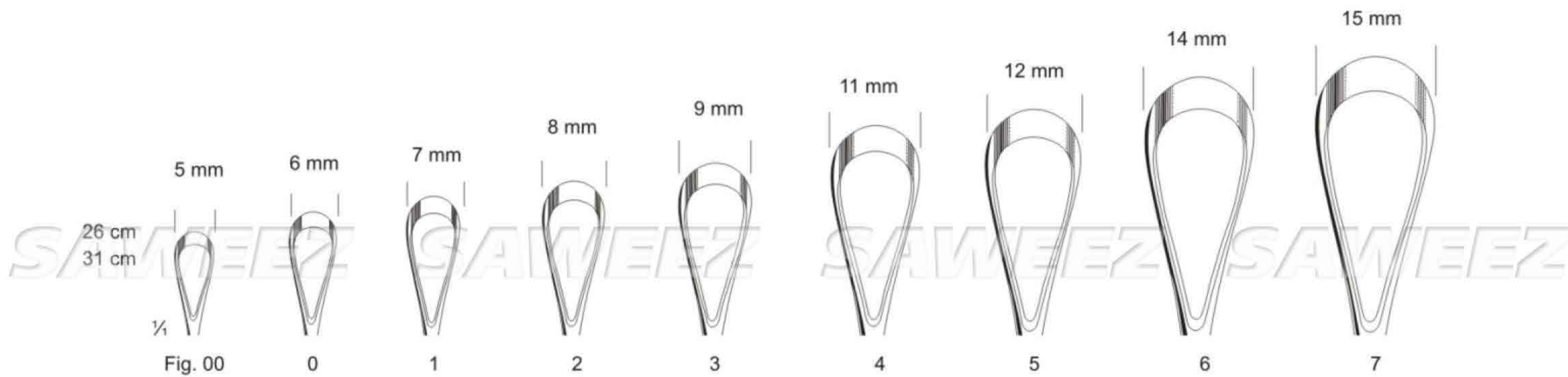
Malleable Curettes
(grooved shaft)



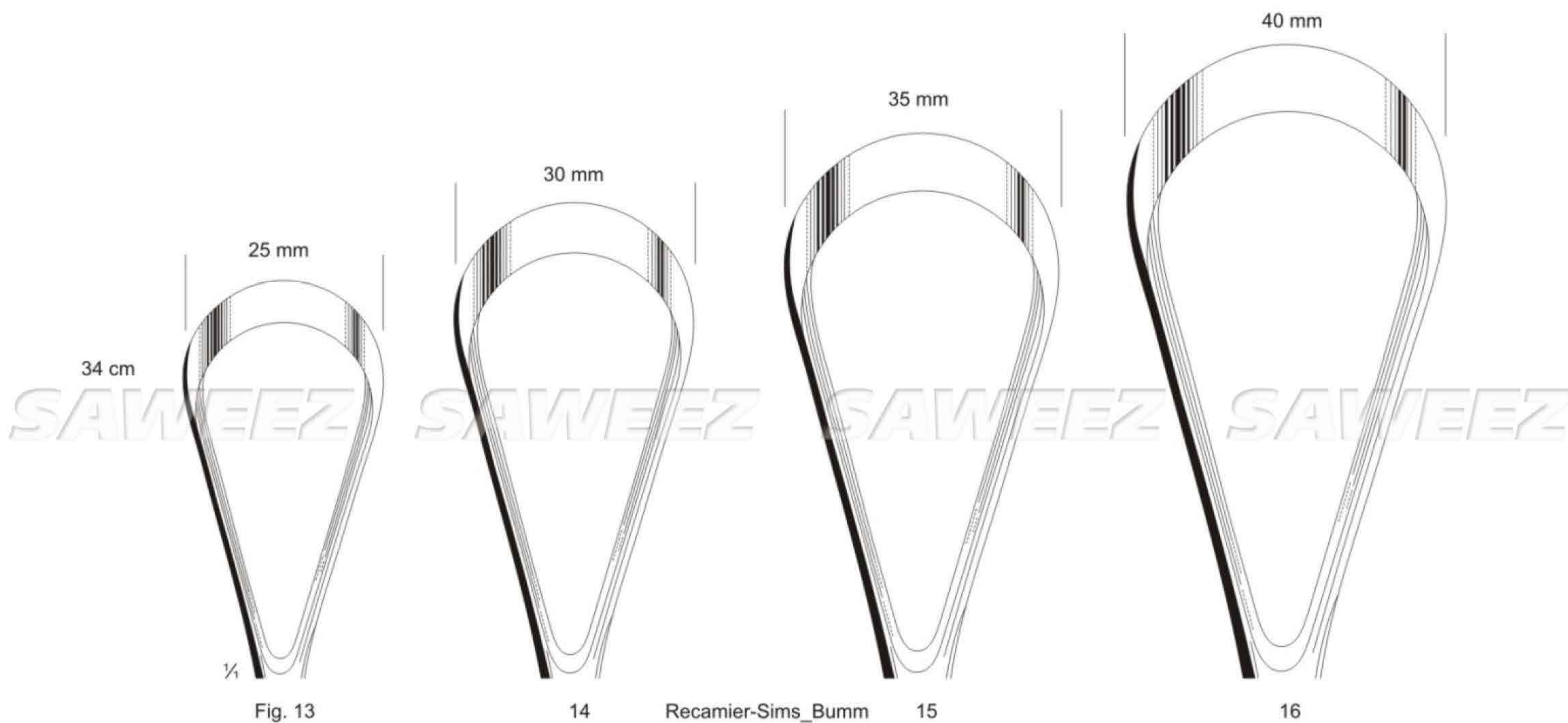
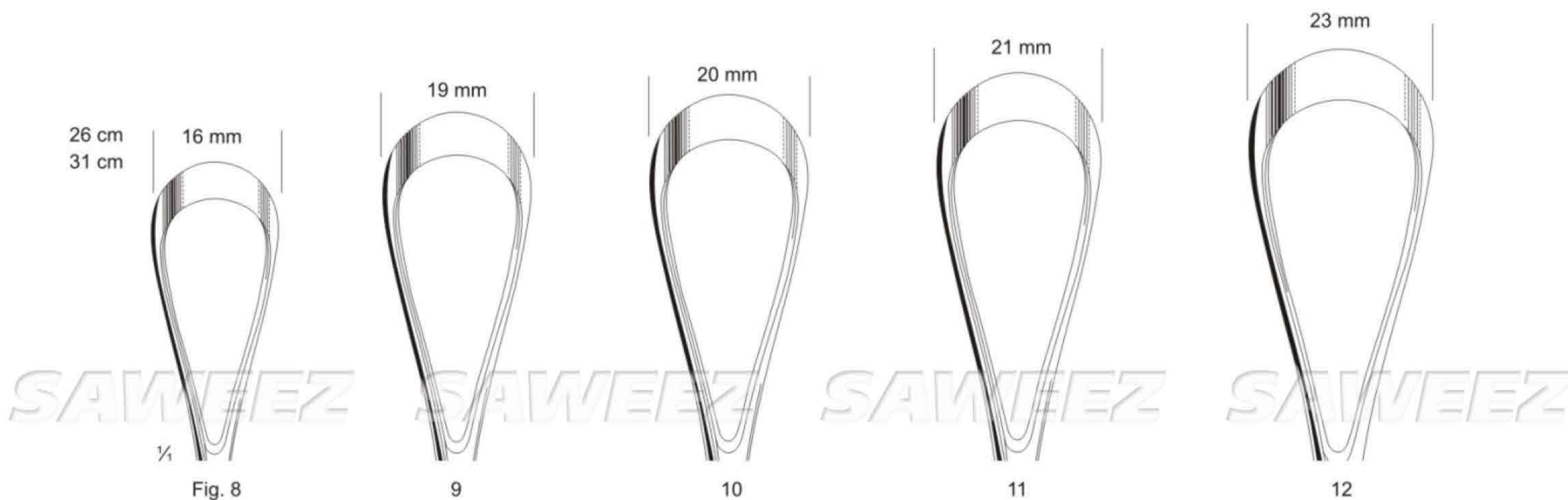
Rigid Curettes
(plain shaft)



Blunt Curettes
(Sims Handle)



Last two digits





Special Model
SSC-39-12-65
34.0 cm / 13½"
cm/inch scale

¼



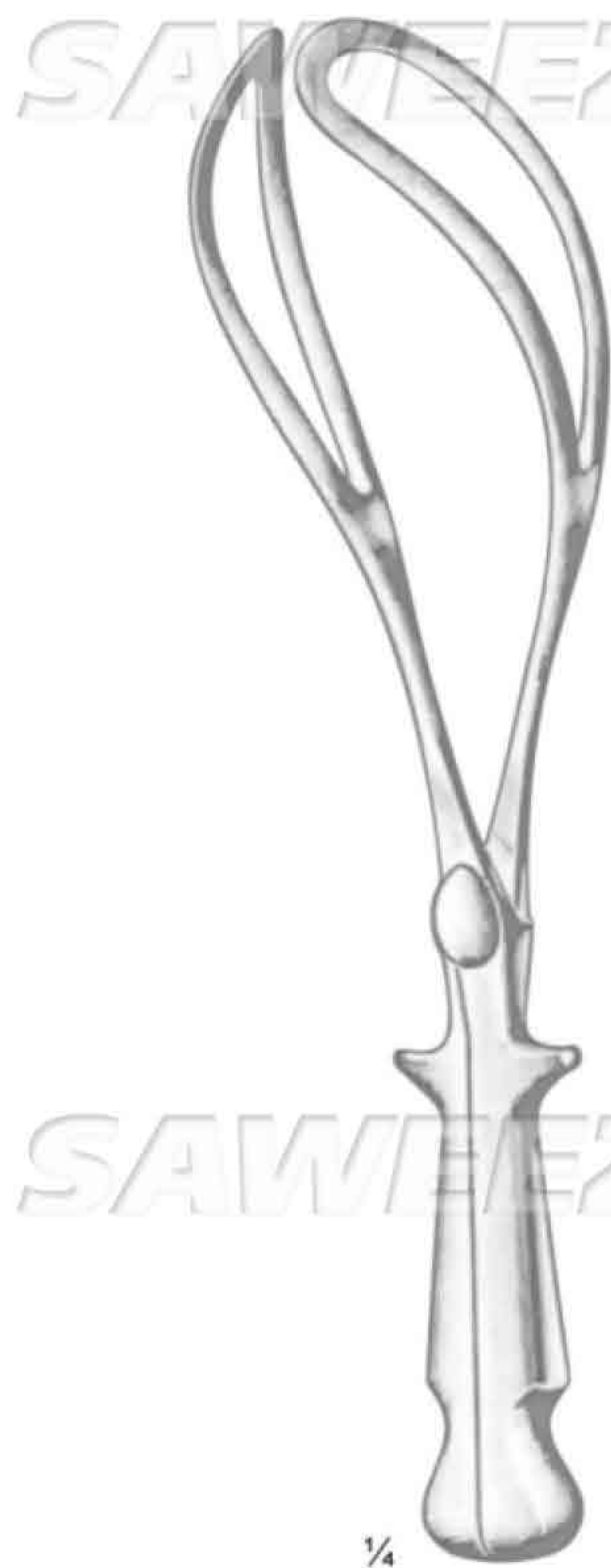
Collin
SSC-39-12-66
35.0 cm / 13¾"
cm scale

¼



Breisky
SSC-39-12-67
33.0 cm / 13"
cm/inch scale

¼



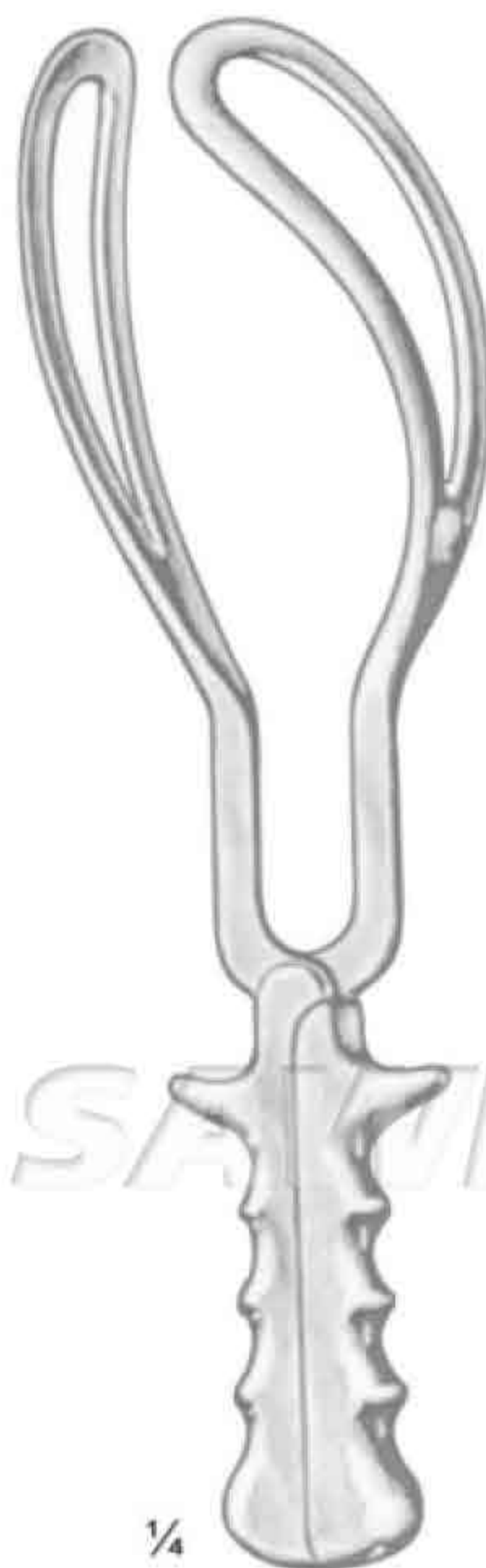
¼

Naegele
SSC-39-12-68 - 36.0 cm / 14"
SSC-39-12-69 - 40.0 cm / 16"



¼

Simpson
SSC-39-12-70
30.0 cm / 12"



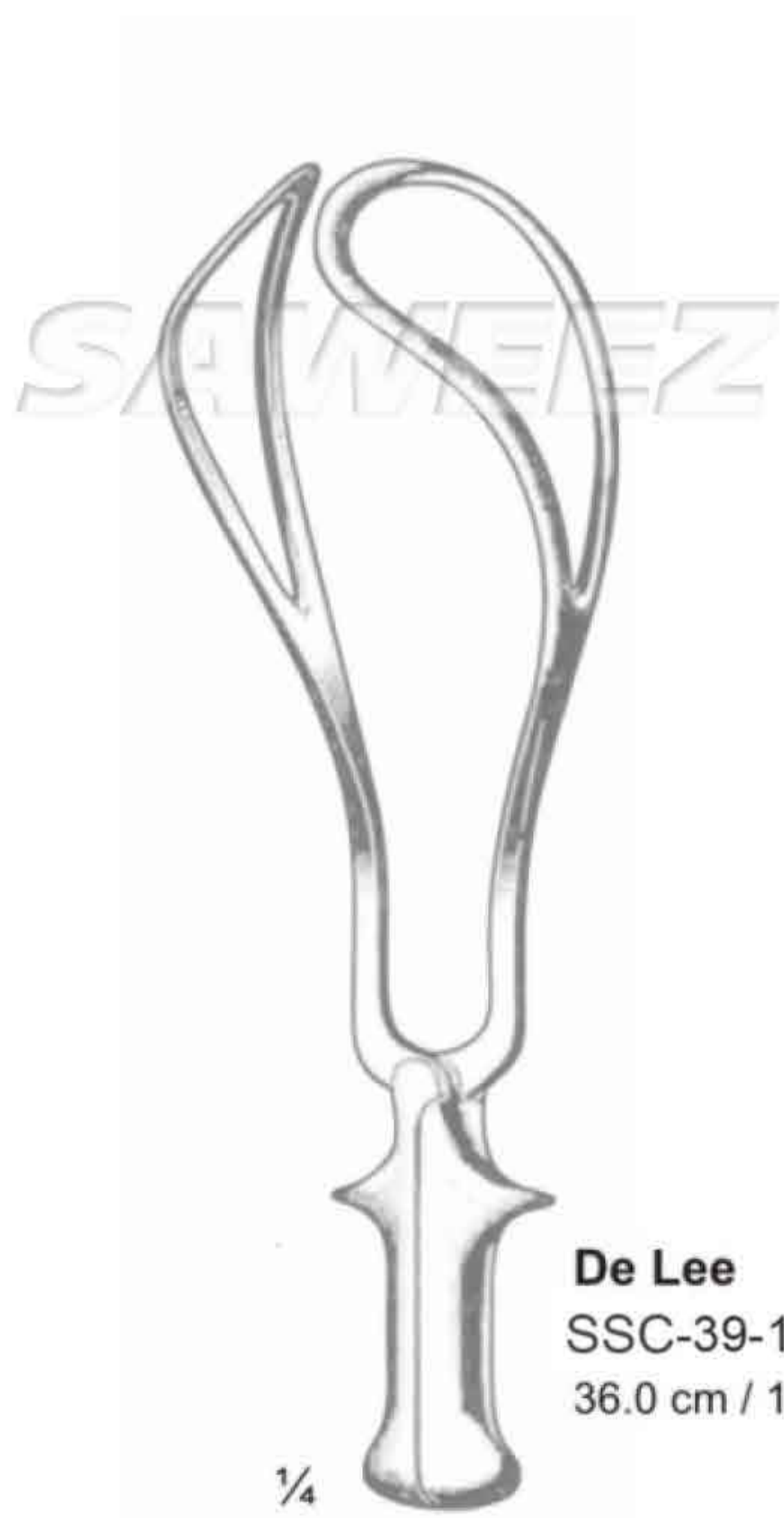
¼

Simpson-Braun
SSC-39-12-71
36.0 cm / 14"



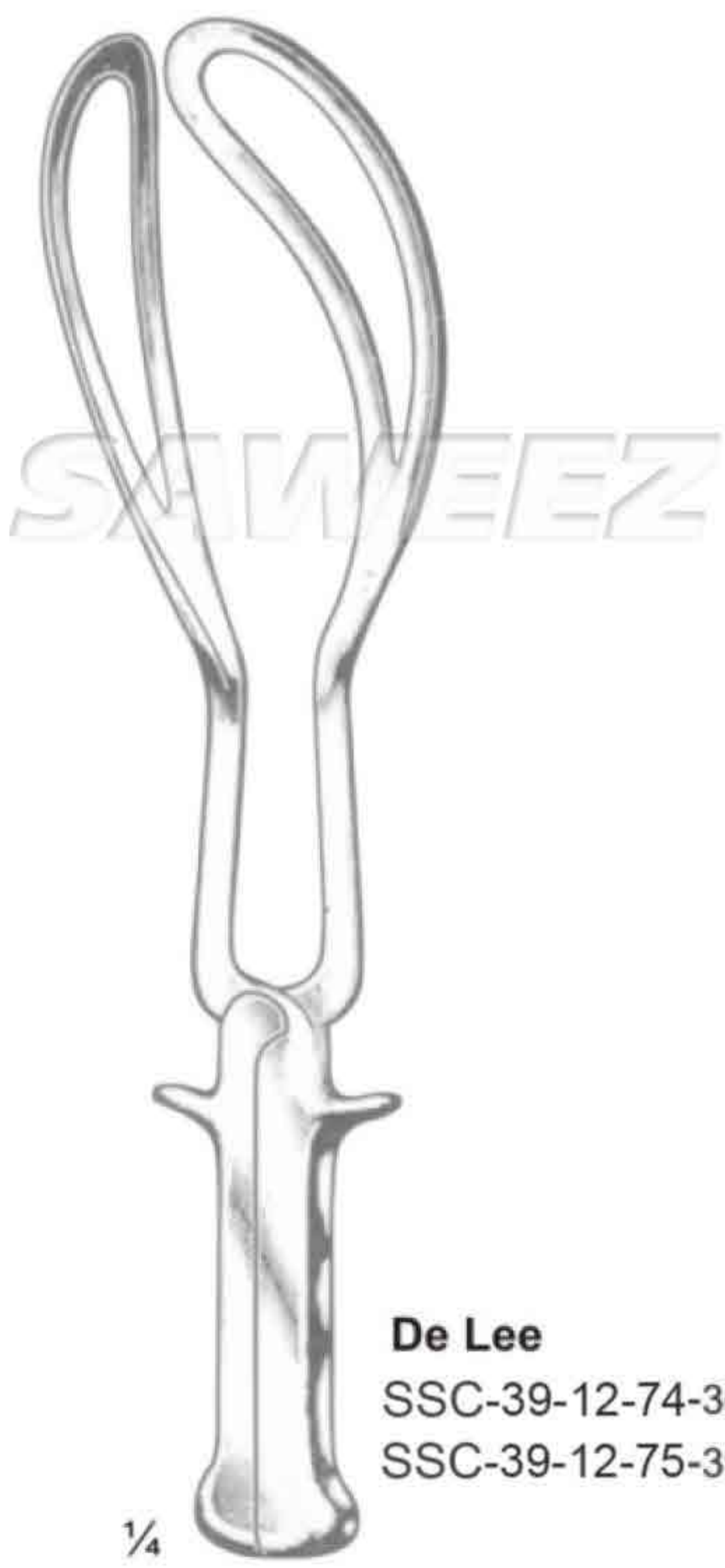
¼

Simpson-Luikart
SSC-39-12-72
36.0 cm / 14"



De Lee
SSC-39-12-73
36.0 cm / 12"

¼



De Lee
SSC-39-12-74-36.0 cm / 14"
SSC-39-12-75-39.0 cm / 15½"

¼



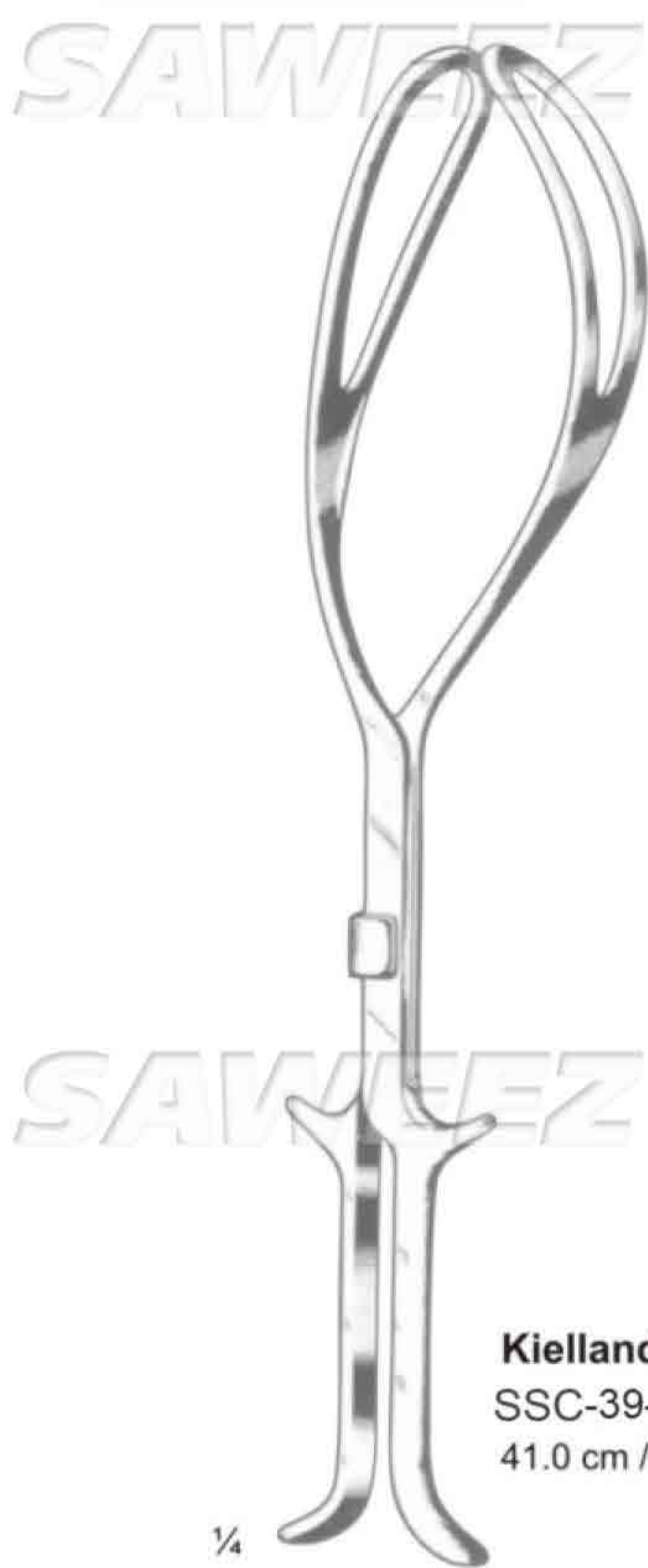
Elliot
SSC-39-12-76
32.0 cm / 12½"
SSC-39-12-77
38.0 cm / 15"

¼



Mc Lean
SSC-39-12-78
36.0 cm / 14"

¼



Kielland
SSC-39-12-79
41.0 cm / 16"

¼



Kielland-Luikart
SSC-39-12-80
40.0 cm / 15¾"

¼



Piper
SSC-39-12-81
44.0 cm / 17¼"

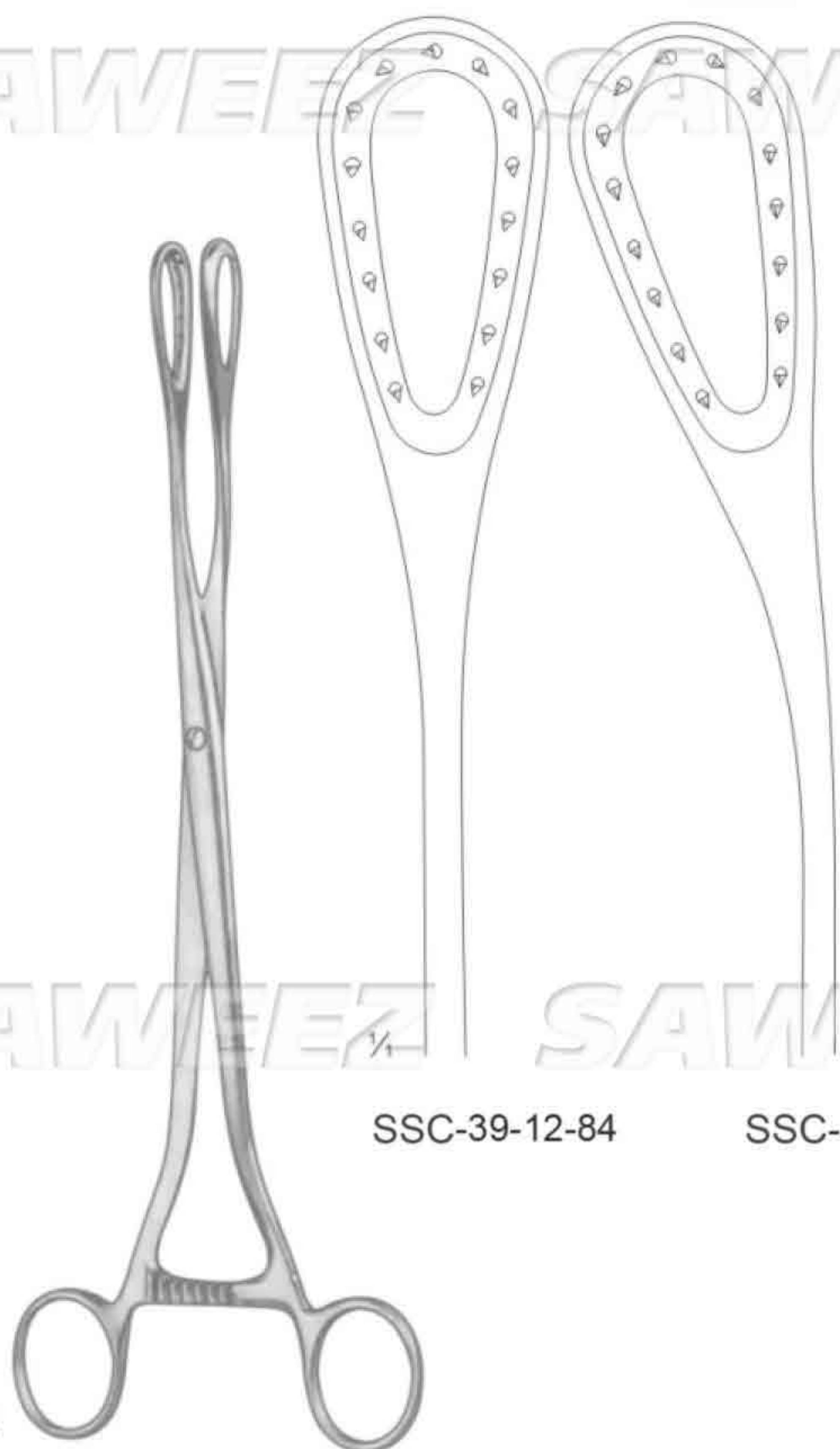
¼



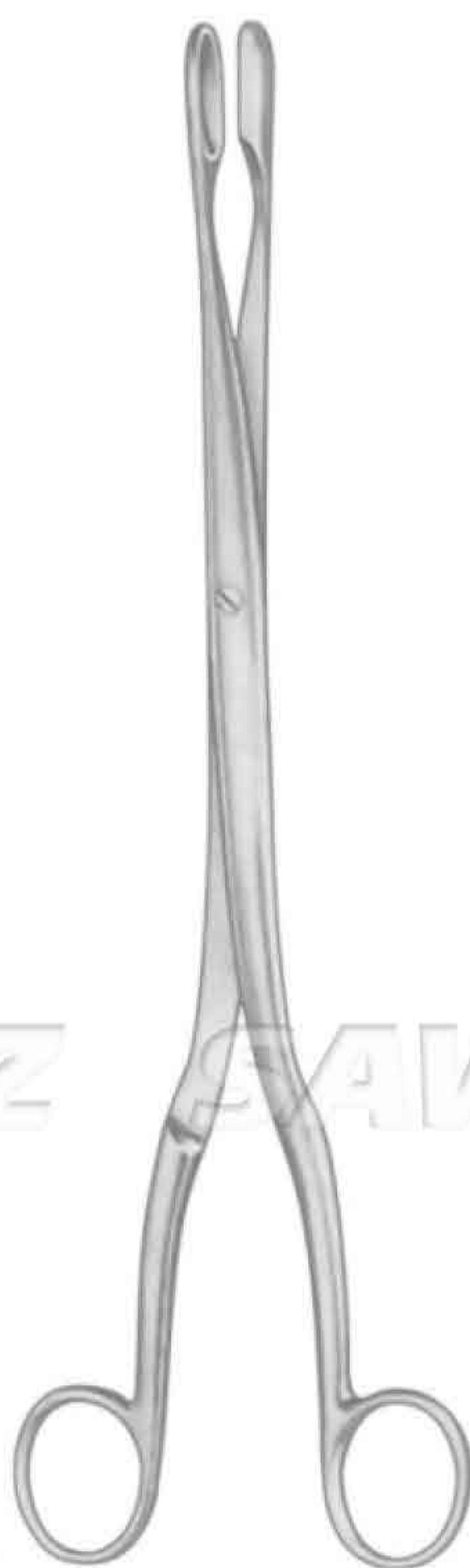
Green-Armytage
SSC-39-12-82
21.0 cm / 8 1/4"



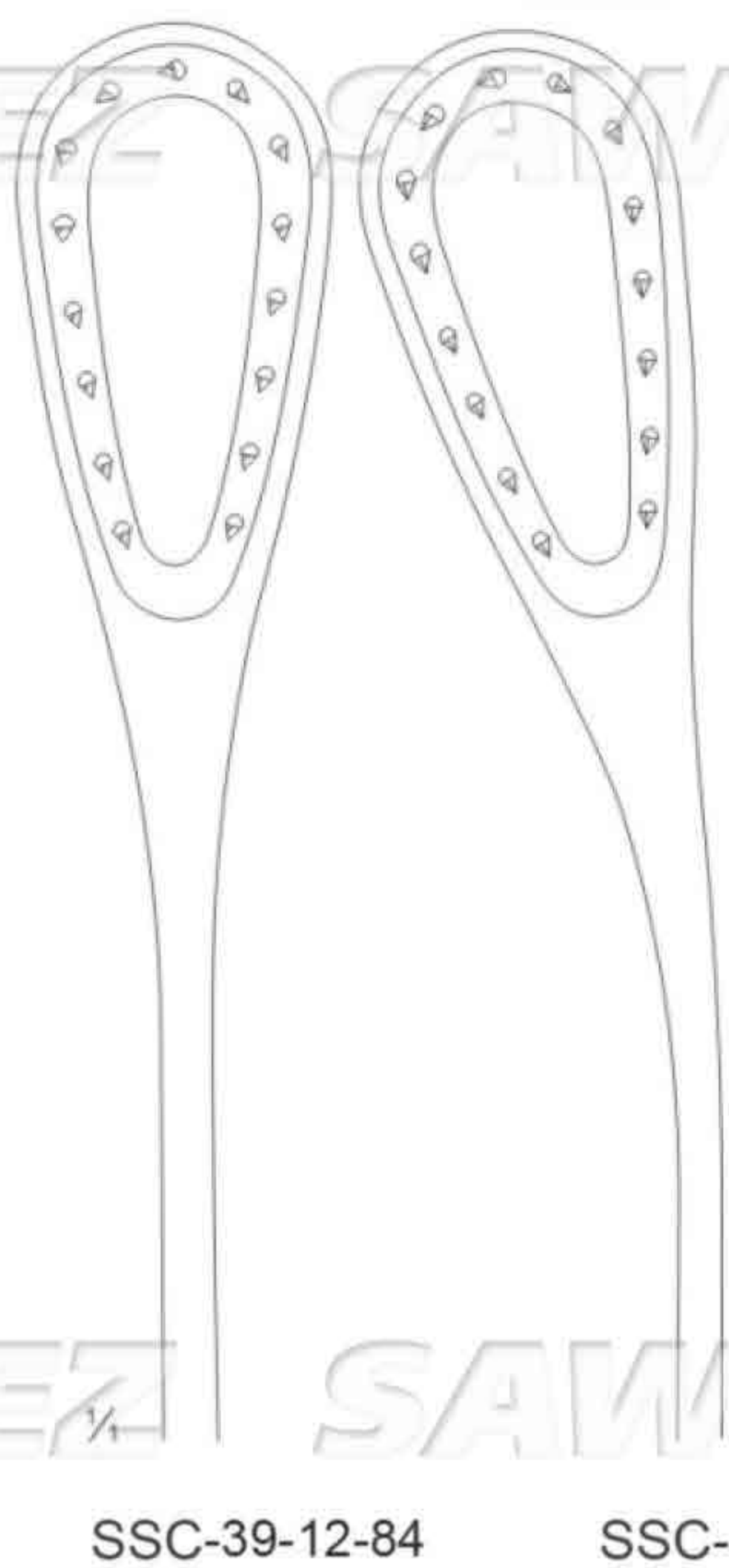
Sellheim
SSC-39-12-83
28.0 cm / 11"



Saenger
27.0 cm / 10 1/2"

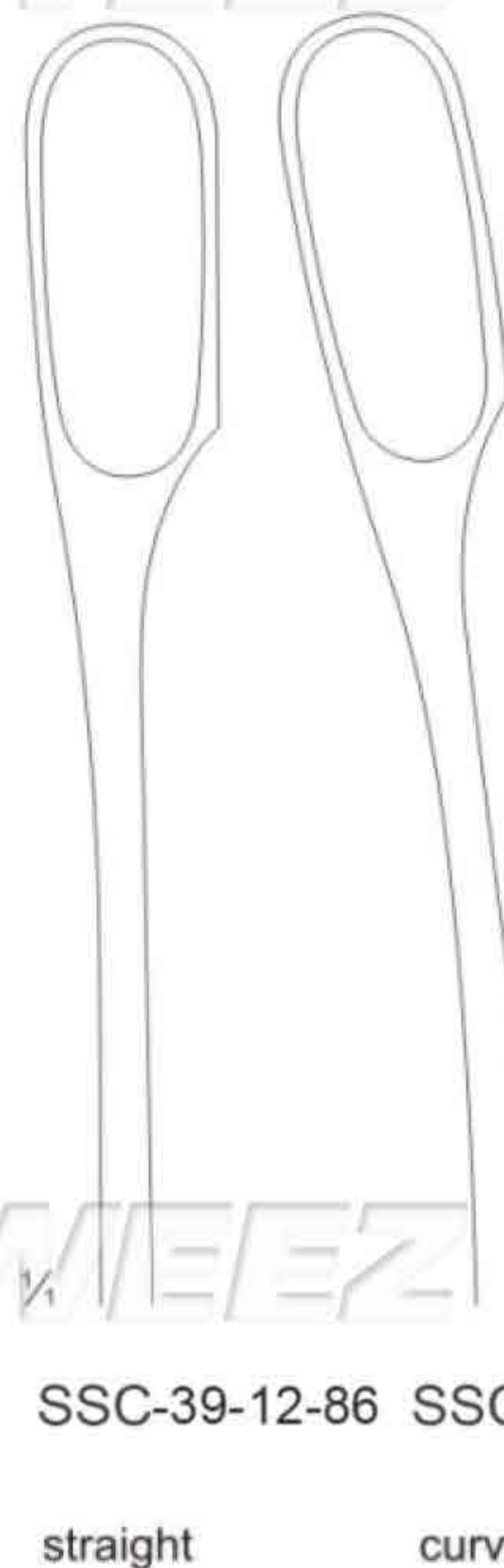


Winter
28.0 cm / 11"



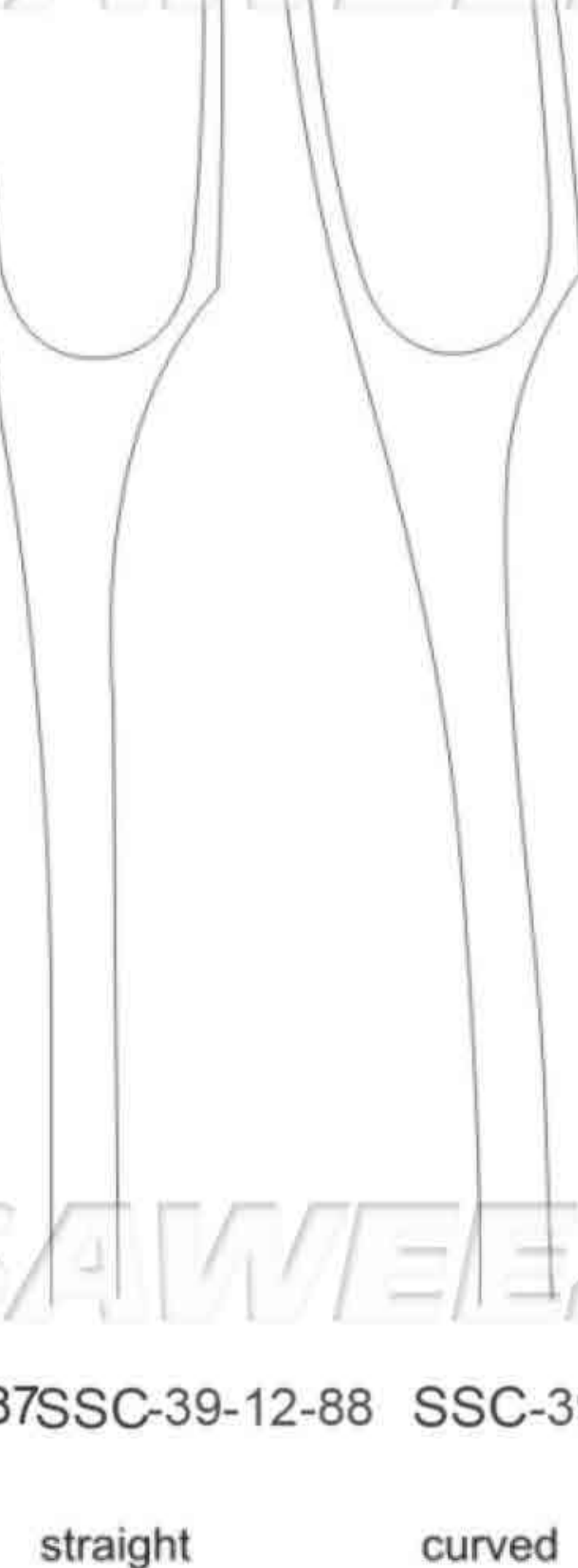
SSC-39-12-84

SSC-39-12-85



SSC-39-12-86

SSC-39-12-87



SSC-39-12-88

SSC-39-12-89

straight

curved

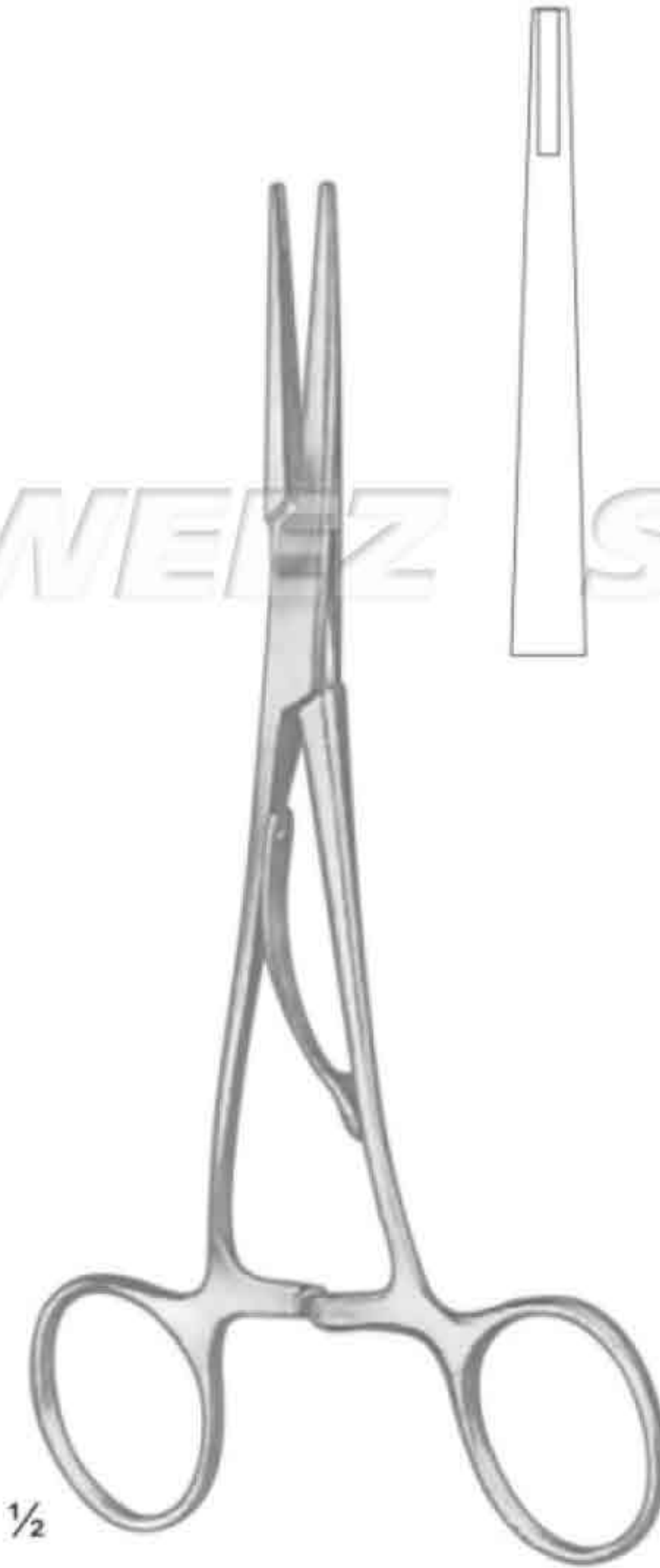
straight

curved



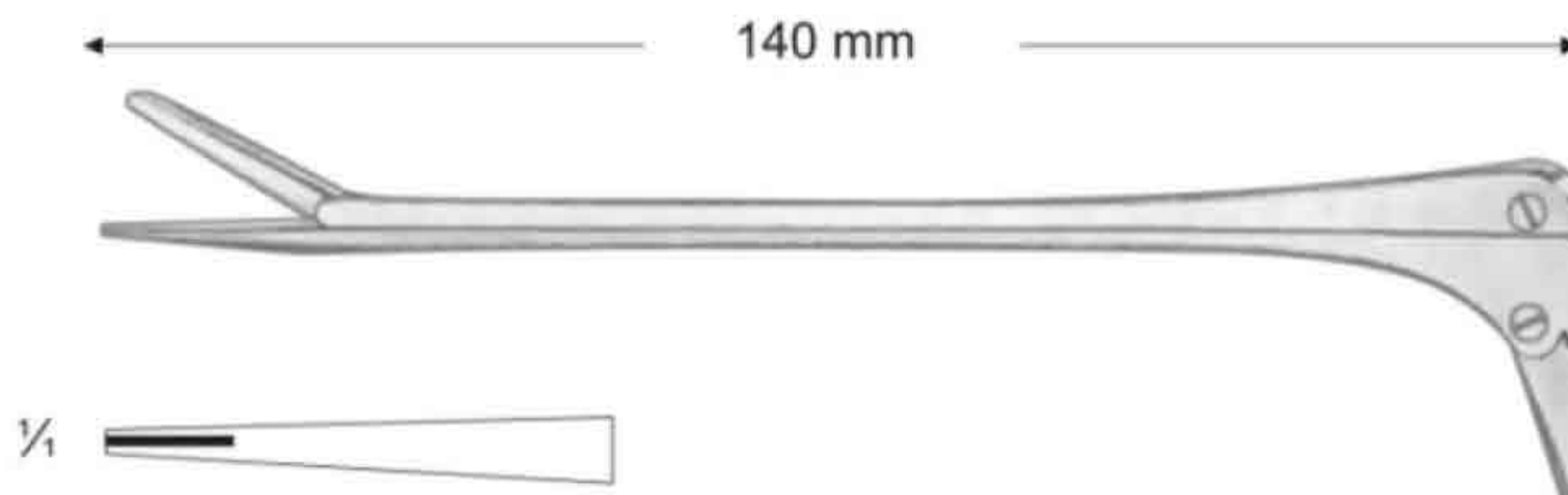
Mckenzie

SCC-41-11-11 - 15.0 cm / 6"
SCC-41-11-12 - 19 cm / 7 1/2"



Mckenzie

SCC-41-11-13 - 15.0 cm / 6"
SCC-41-11-14 - 19 cm / 7 1/2"



1/2

Olivercrona-Toennis
(Scoville)
SCC-41-11-15



SAWEEZ SAWEEZ SAWEEZ SAWEEZ



Penfield
SSC-41-11-18
17.5 cm / 7"
Fig. 1

Penfield
SSC-41-11-19
19.5 cm / 7¾"
Fig. 2

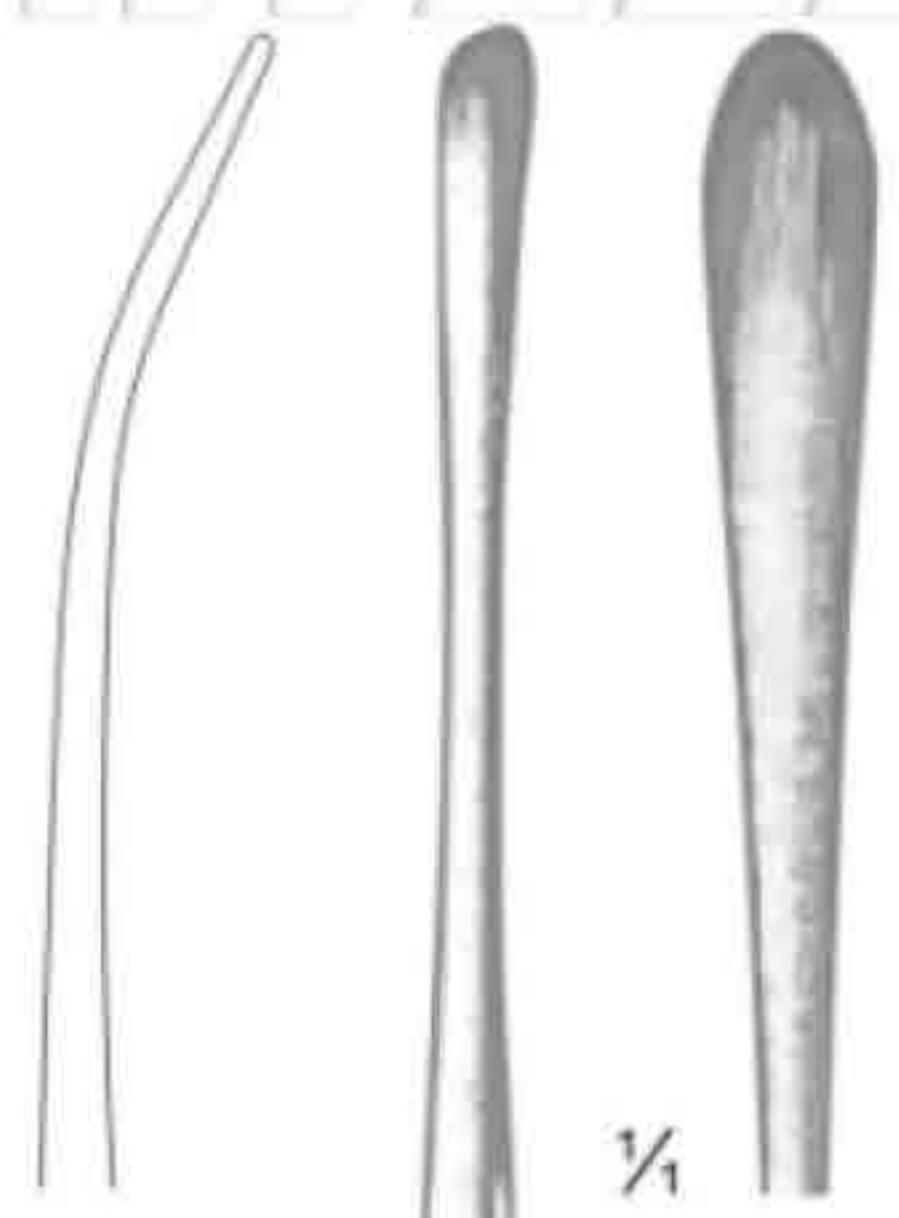
Penfield
SSC-41-11-20
19.5 cm / 7¾"
Fig. 3

Penfield
SSC-41-11-21
21.5 cm / 8½"
Fig. 4

Penfield
SSC-41-11-22
29.0 cm / 11½"
Fig. 5



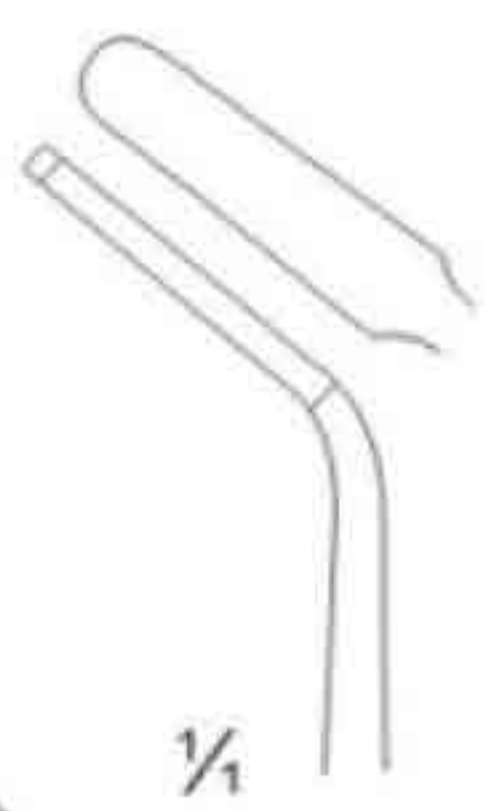
SAWEEZ SAWEEZ SAWEEZ SAWEEZ



Davis
SSC-41-11-23
24.5 cm / 9 3/4"



Frazier
SSC-41-11-24
15.0 cm / 6"



Hoen
SSC-41-11-25
15.0 cm / 6"



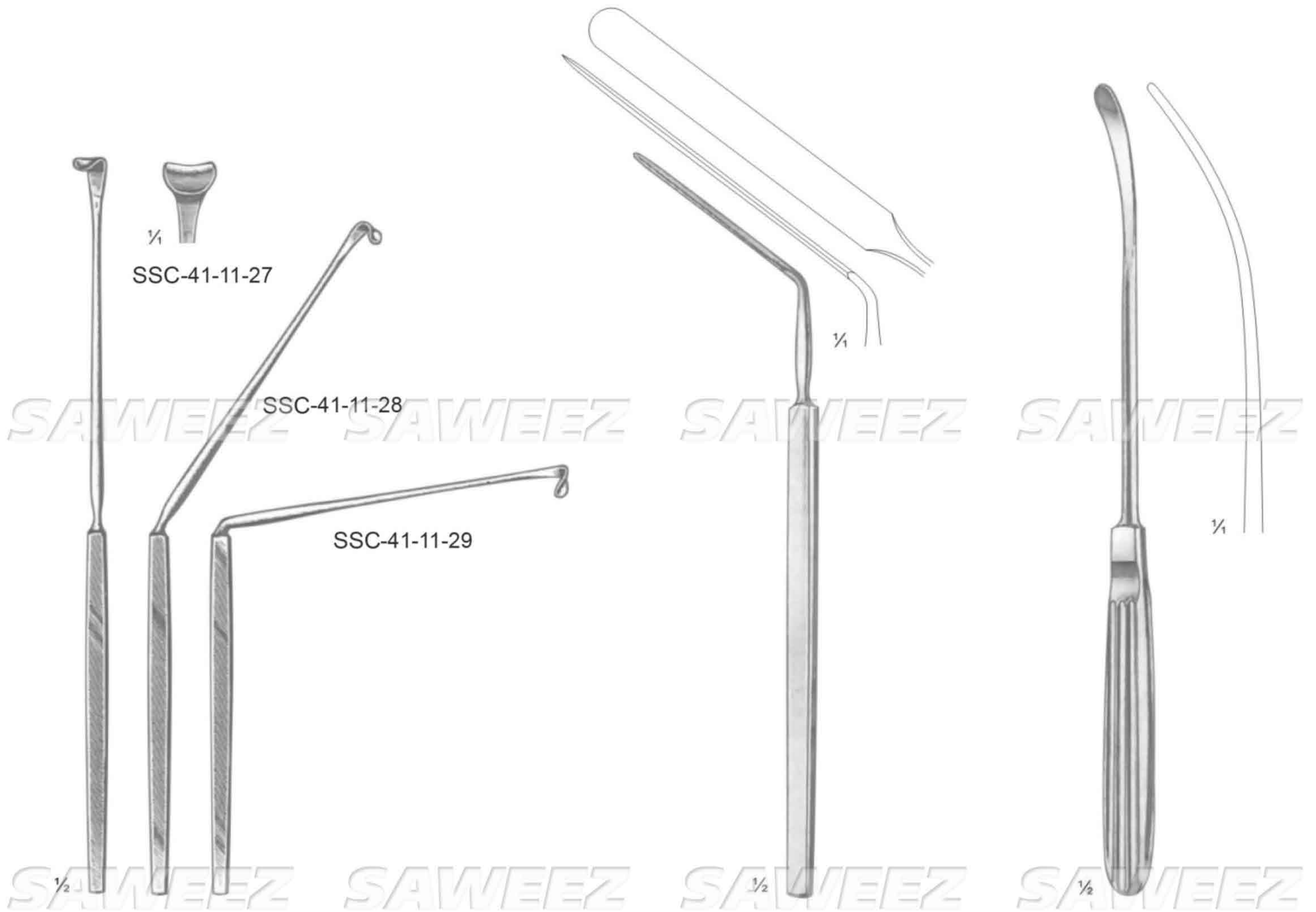
Hoen
SSC-41-11-26
15.0 cm / 6"

SAWEEZ SAWEEZ SAWEEZ SAWEEZ

SAWEEZ SAWEEZ SAWEEZ SAWEEZ



SAWEEZ SAWEEZ SAWEEZ SAWEEZ



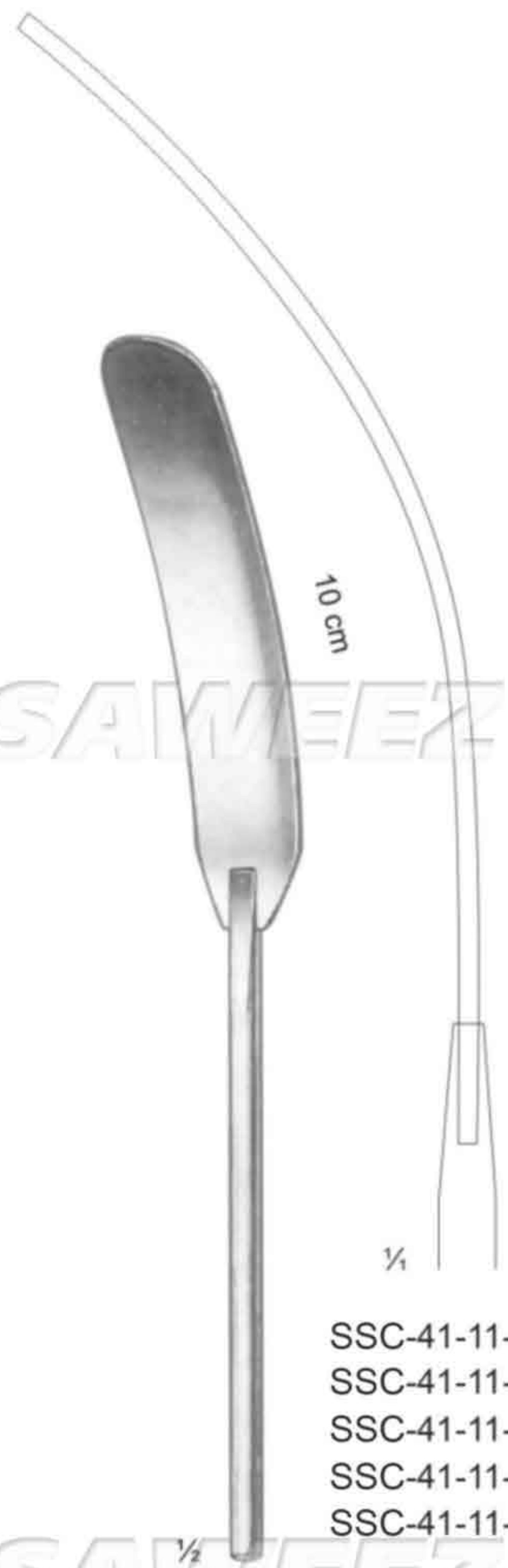
Love

Horsley
SSC-41-11-30
20.0 cm / 8"

Sachs
SSC-41-11-31
21.0 cm / 8 1/4"



SAWEEZ SAWEEZ SAWEEZ SAWEEZ



- SSC-41-11-32 - 8 mm
- SSC-41-11-33 - 11 mm
- SSC-41-11-34 - 14 mm
- SSC-41-11-35 - 17 mm
- SSC-41-11-36 - 20 mm

Heifetz
20.0 cm / 8"
malleable



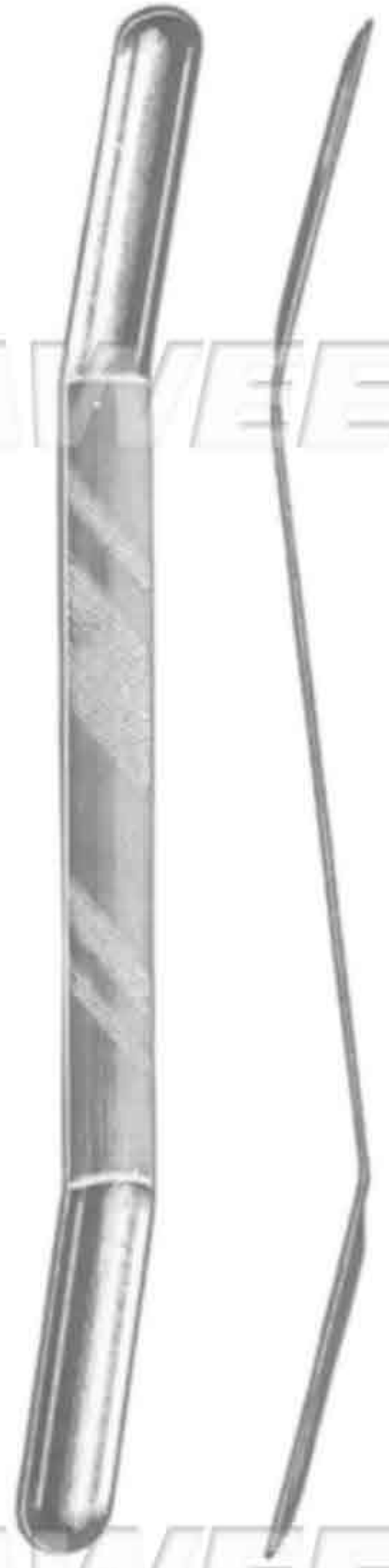
- SSC-41-11-37
17.0 cm / 6 3/4"
8 x 10 mm
- SSC-41-11-38
20.0 cm / 8"
13 x 15 mm
- SSC-41-11-39
28.0 cm / 11"
16 x 18 mm

Cushing



Olivercrona
18.0 cm / 7"

width of spatulas



	upper end mm	lower end mm	
concave			convex
SSC-41-11-40	7	9	SSC-41-11-44
SSC-41-11-41	11	13	SSC-41-11-45
SSC-41-11-42	15	18	SSC-41-11-46
SSC-41-11-43	18	22	SSC-41-11-47

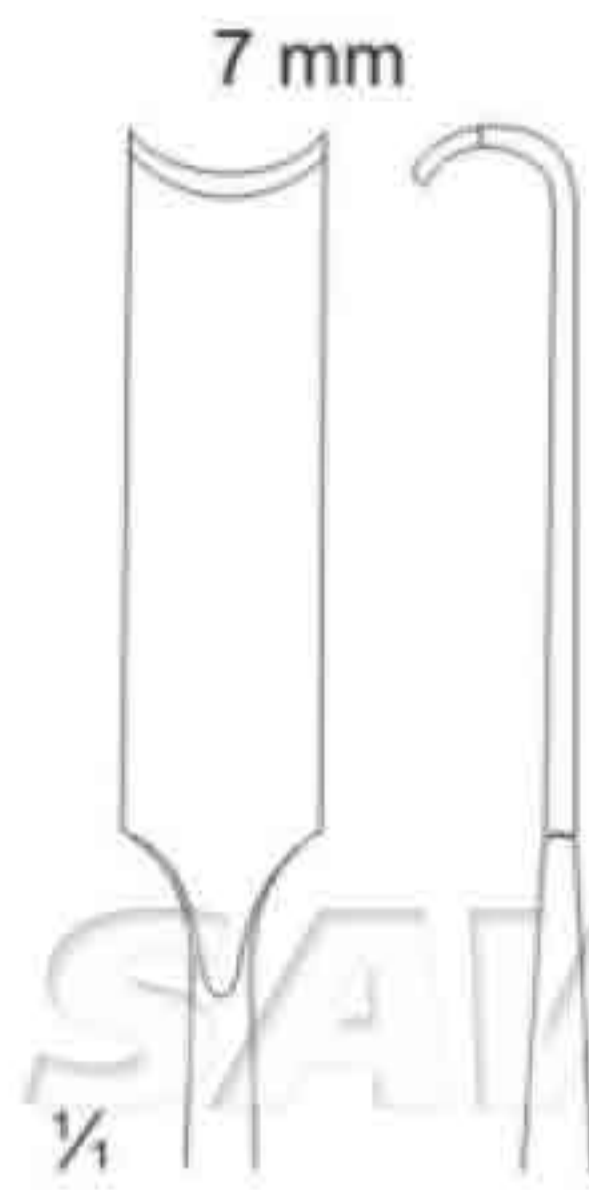
SAWEEZ SAWEEZ SAWEEZ SAWEEZ



SSC-41-11-48
23.0 cm / 9"

1/2

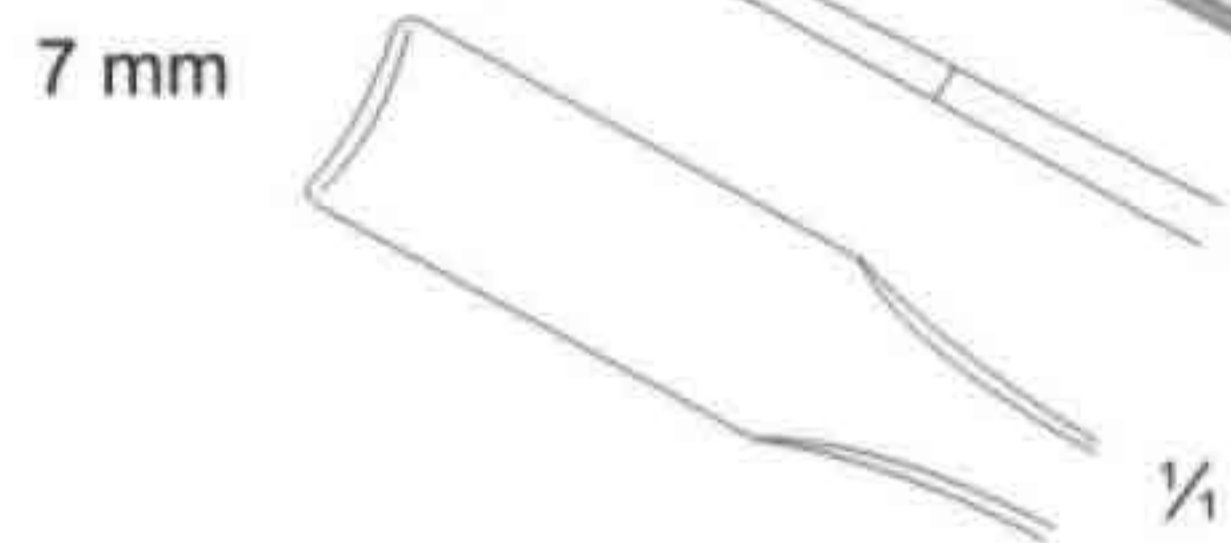
Scoville



SSC-41-11-49
24.0 cm / 9 1/2"

1/2

Holsher



SSC-41-11-50
20.0 cm / 8"

1/2

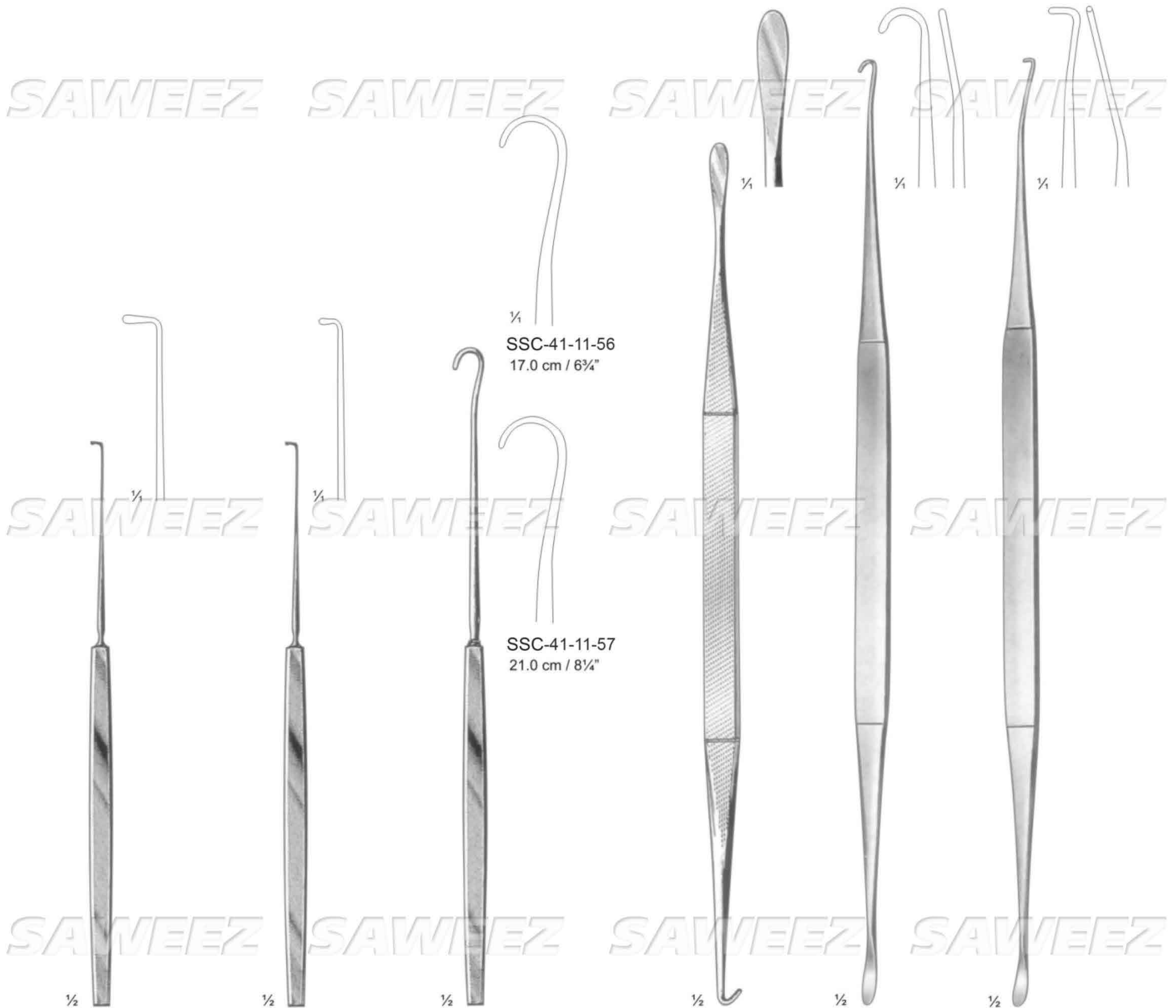
Scoville



SSC-41-11-51
21.0 cm / 8 1/2"

1/2

Special Mode



Cushing
SSC-41-11-52
19.0 cm / 7½"
SSC-41-11-53
28.0 cm / 11"

Cushing
SSC-41-11-54
19.0 cm / 7½"
SSC-41-11-55
28.0 cm / 11"

Smithwick

¼
SSC-41-11-56
17.0 cm / 6¾"

¼
SSC-41-11-57
21.0 cm / 8¼"

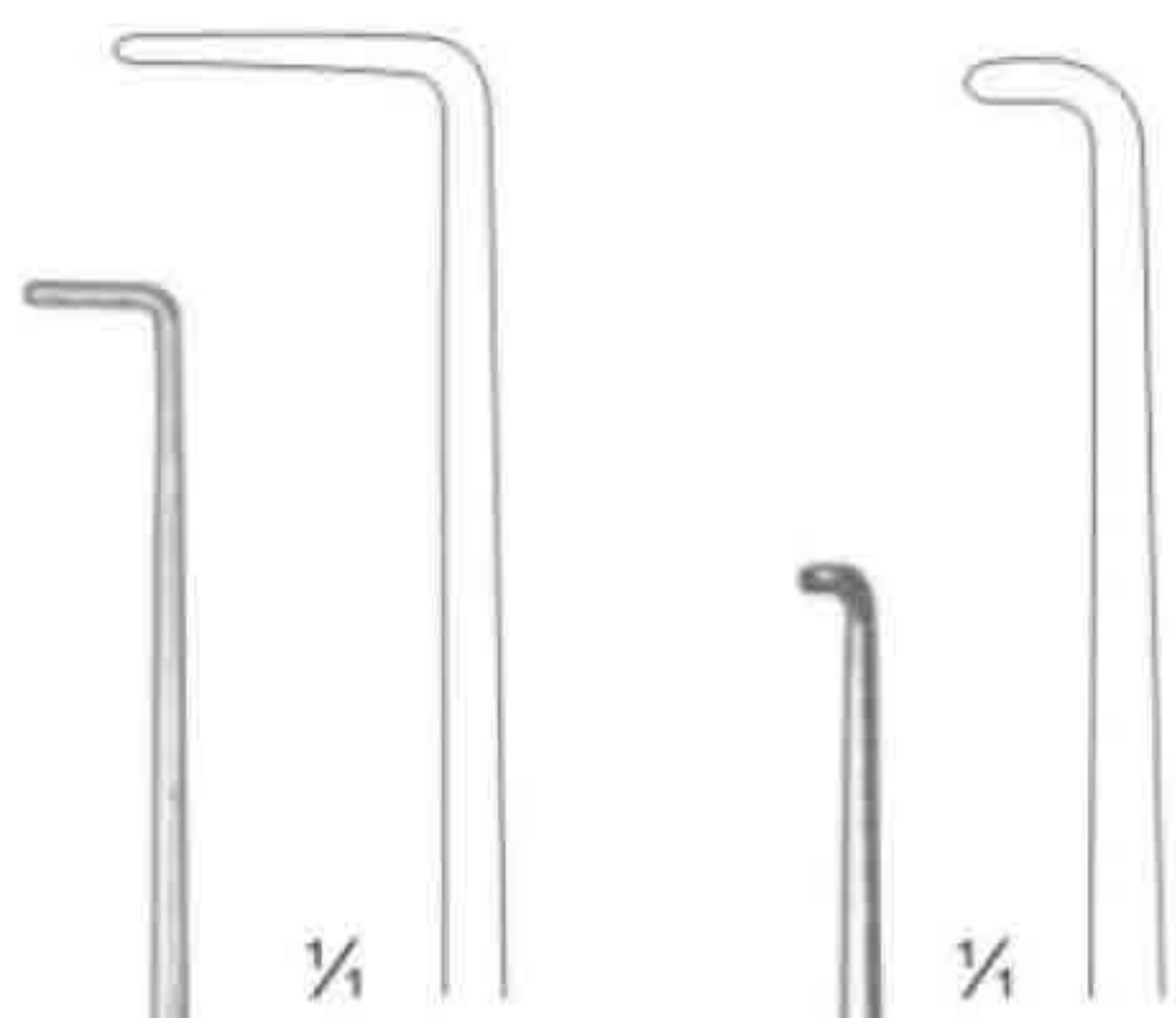
Smithwick
SSC-41-11-58
29.0 cm / 11½"

Scoville
SSC-41-11-59
30.0 cm / 12"

Scoville
SSC-41-11-60
30.0 cm / 12"



SAWEEZ SAWEEZ SAWEEZ SAWEEZ



1/4

1/4

1/2

1/2

Hoen

SSC-41-11-61
22.0 cm / 8 3/4"

Dandy

SSC-41-11-62
20.0 cm / 8"



1/4

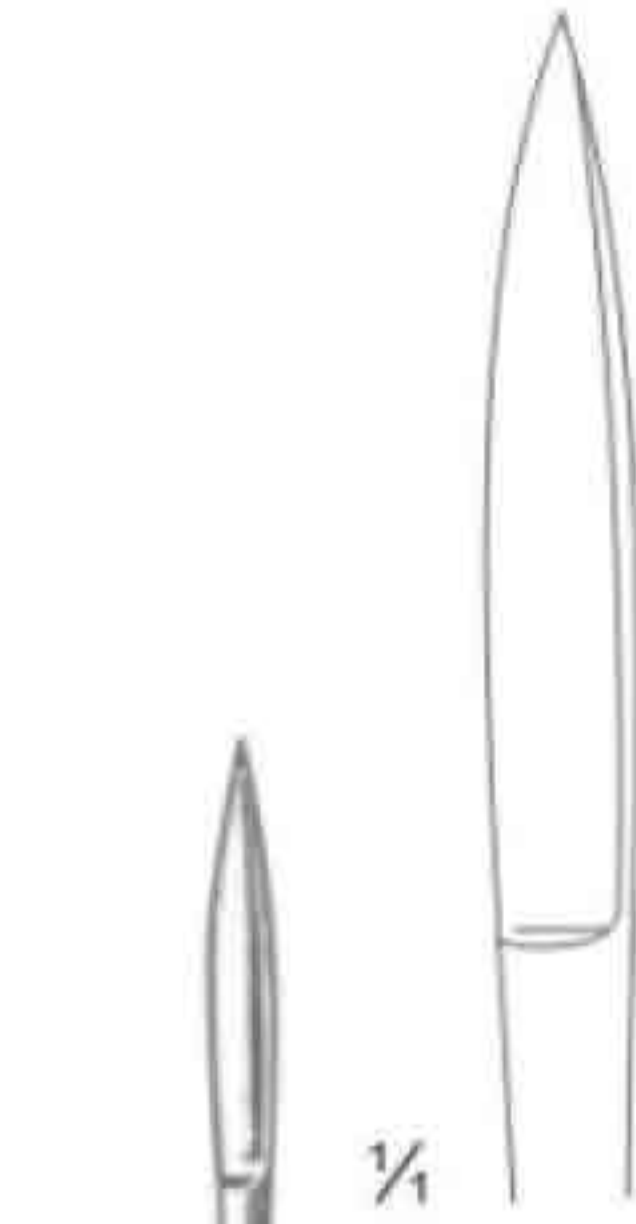
SSC-41-11-63
13.0 cm / 5"



SSC-41-11-65
19.0 cm / 7 1/2"

1/2

Toennis



1/4

1/2

Halle

SSC-41-11-66
20.0 cm / 8"



1/4

1/2

Adson

SSC-41-11-67
20.0 cm / 8"



1/4

1/2

Graham

SSC-41-11-68
16.5 cm / 6 1/2"



1/4

1/2

Sachs

SSC-41-11-69
18.5 cm / 7 1/4"



1/4

1/2

Toennis

SSC-41-11-70
15.0 cm / 6"

SAWEEZ SAWEEZ SAWEEZ SAWEEZ

SAWEEZ SAWEEZ SAWEEZ SAWEEZ



SAWEEZ SAWEEZ SAWEEZ SAWEEZ



1/2

Lahey

SSC-41-11-71
13.0 cm / 5"



1/2

Cushing

SSC-41-11-72
14.0 cm / 5 1/2"



1/2

Fraizier



1/4

SSC-41-11-73
13.0 cm / 5"

sharp



1/4

SSC-41-11-75
13.0 cm / 5"

blunt



SSC-41-11-74
18.0 cm / 7"

sharp



SSC-41-11-76
18.0 cm / 7"

blunt

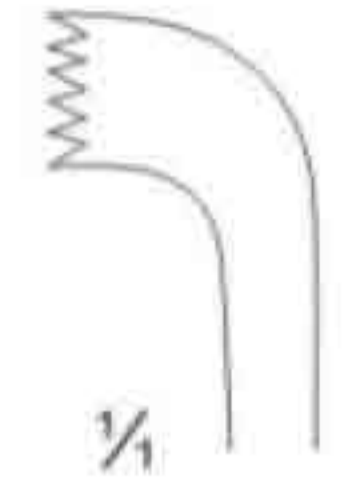


1/2

Adson

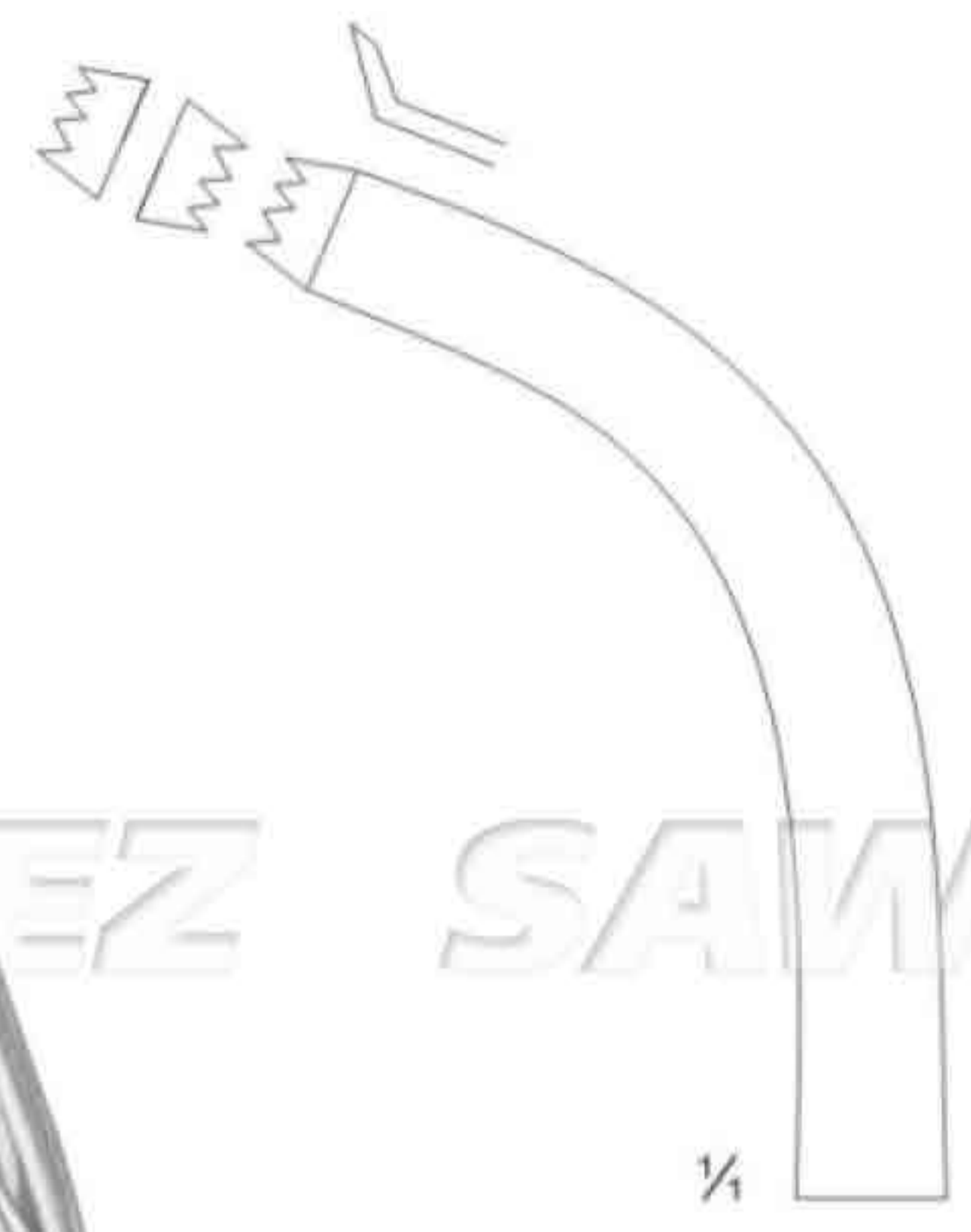
SSC-41-11-77
20.0 cm / 8"

SAWEEZ SAWEEZ SAWEEZ SAWEEZ



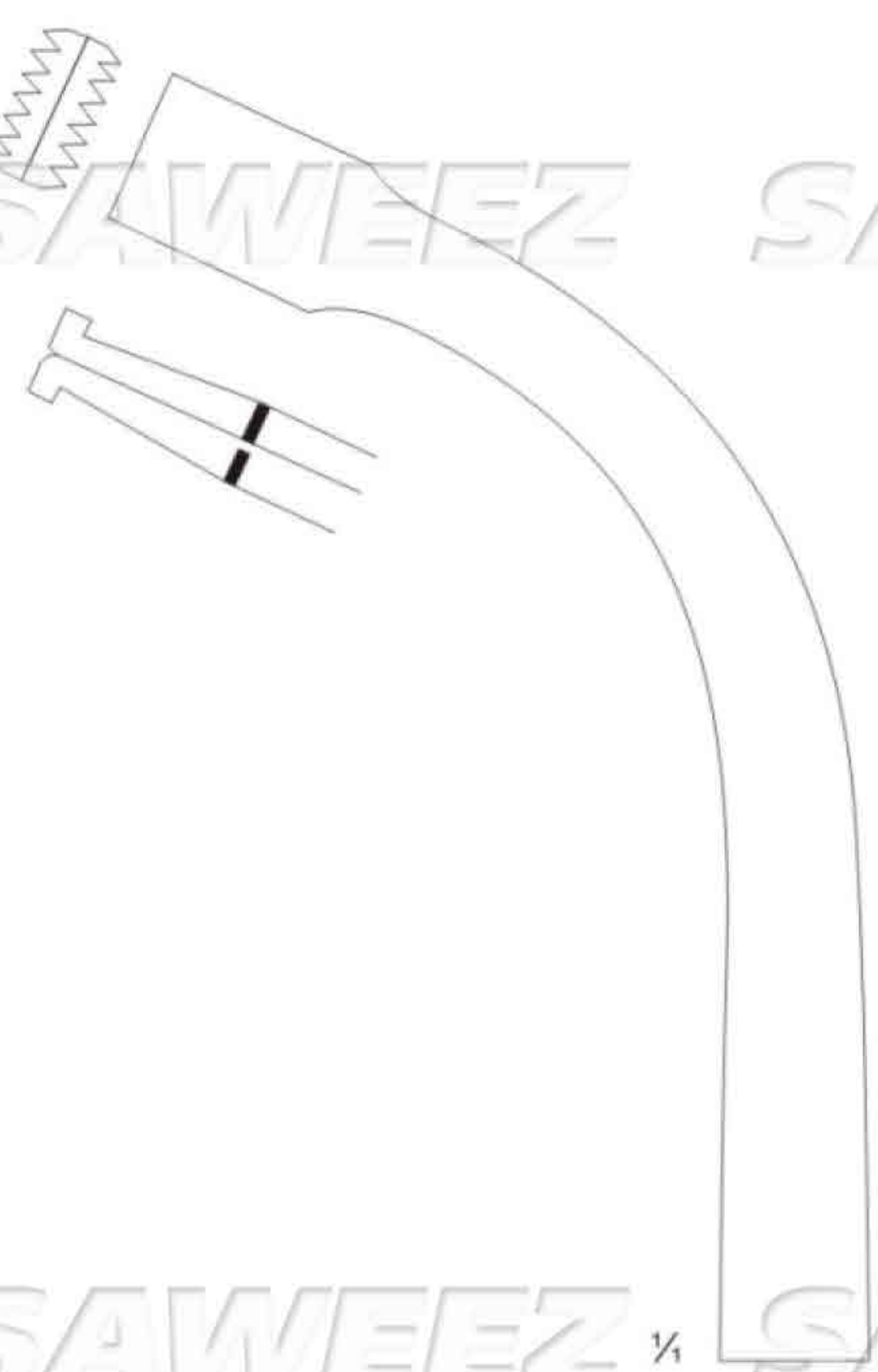
SSC-41-11-78
16.0 cm / 6 1/4"

Cloward



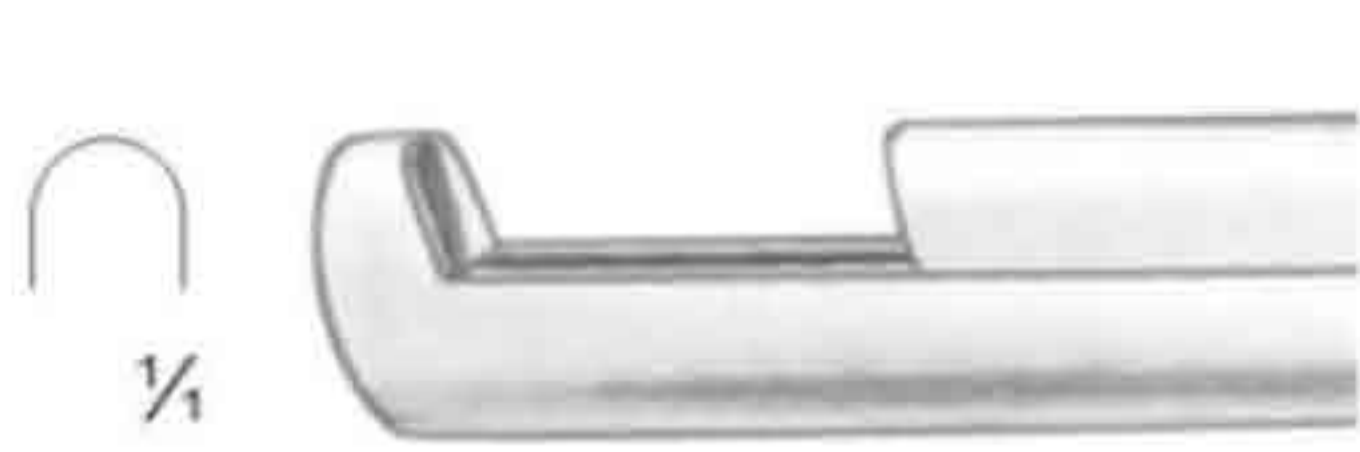
SSC-41-11-79
16.5 cm / 6 1/2"

Inge



SSC-41-11-80
27.0 cm / 10 3/4"

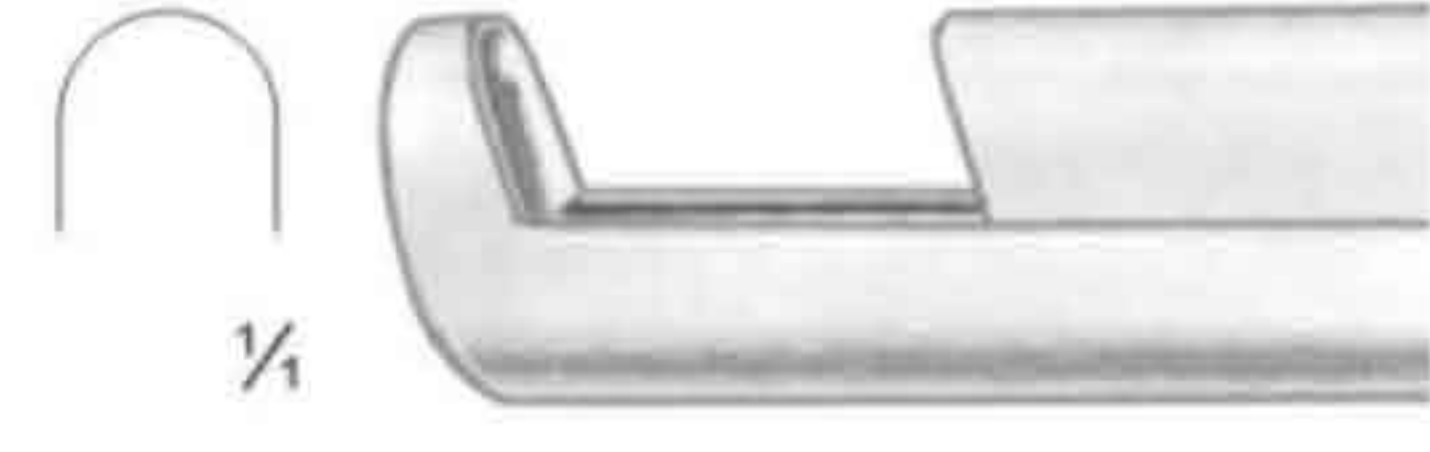
Inge



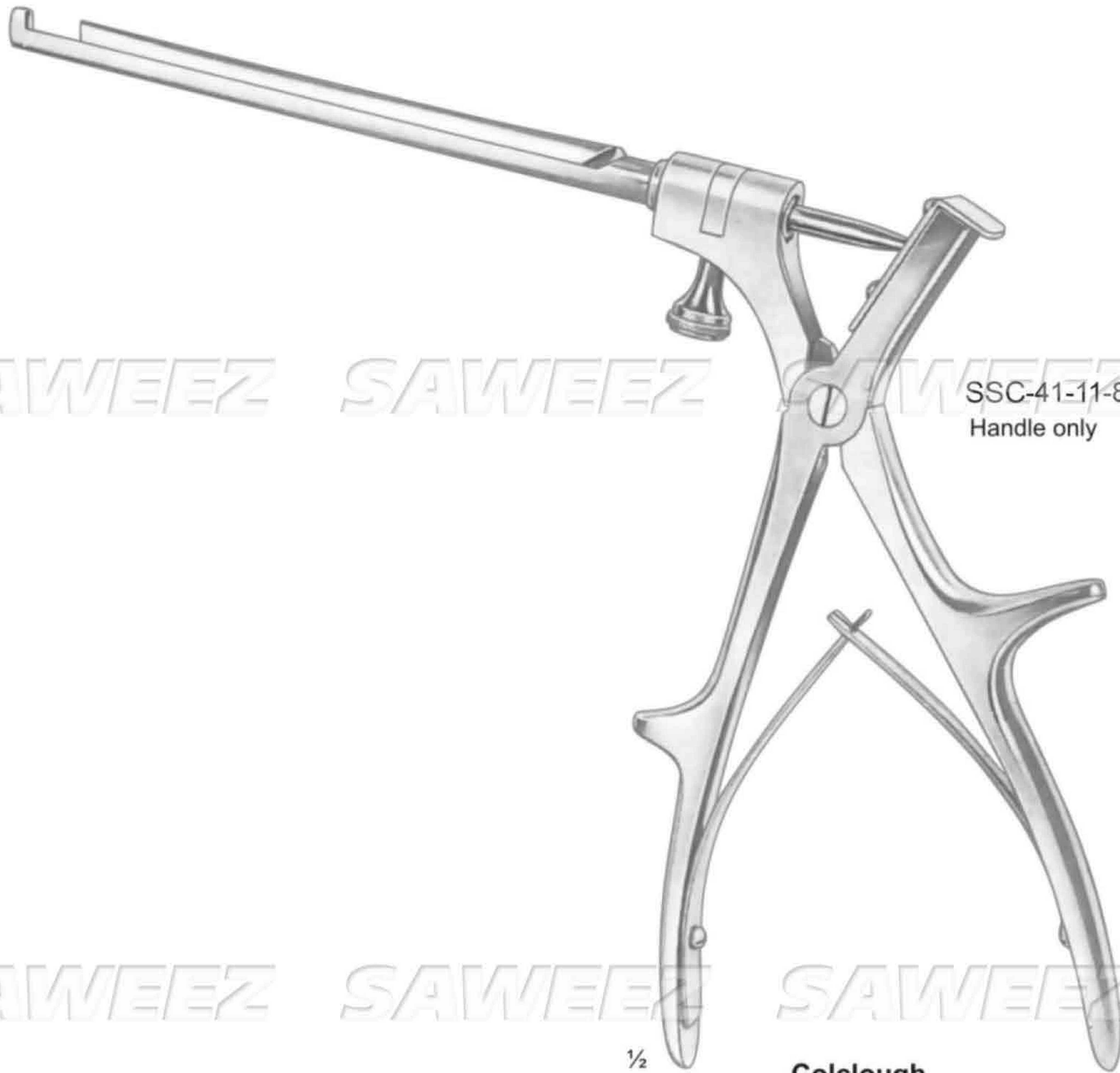
SSC-41-11-81
width of jaw 4 mm



SSC-41-11-82
width of jaw 5 mm



SSC-41-11-83
width of jaw 6 mm

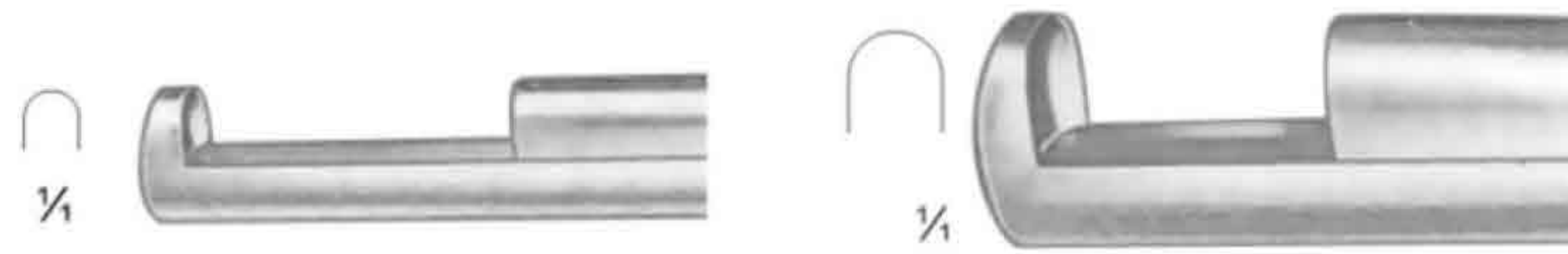


SSC-41-11-84
Handle only

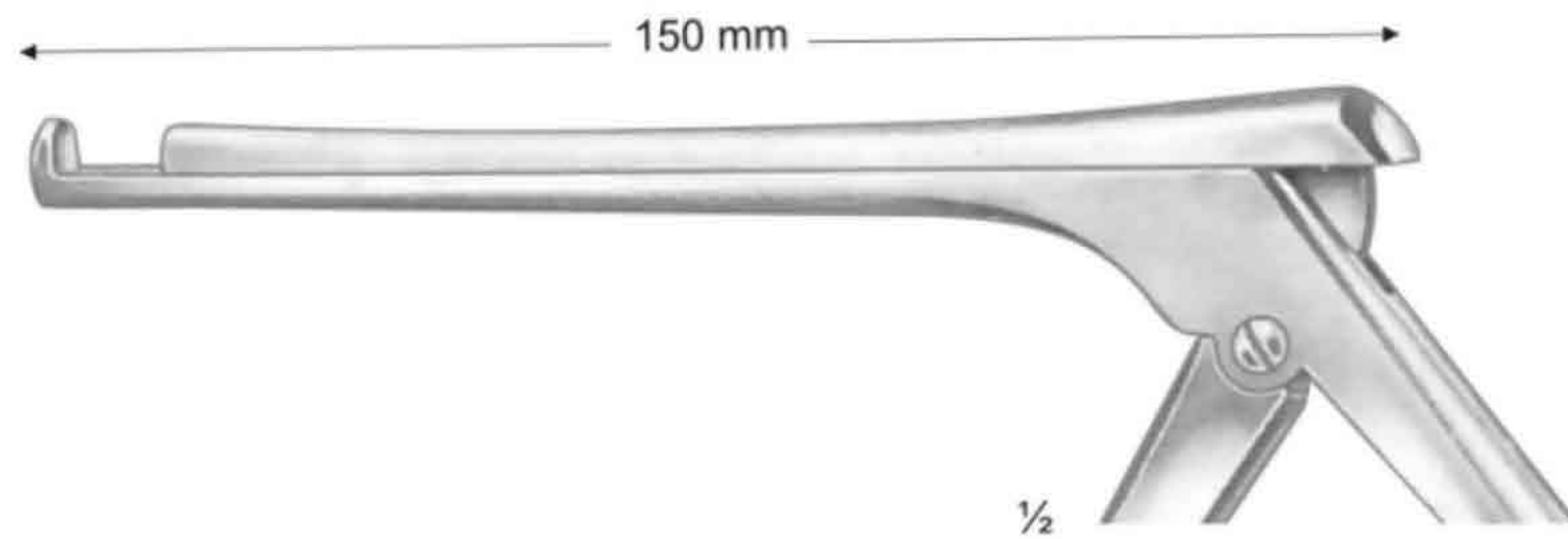
1/2

Colclough
SSC-41-11-85
rotating

consists of 3 interchangeable tips



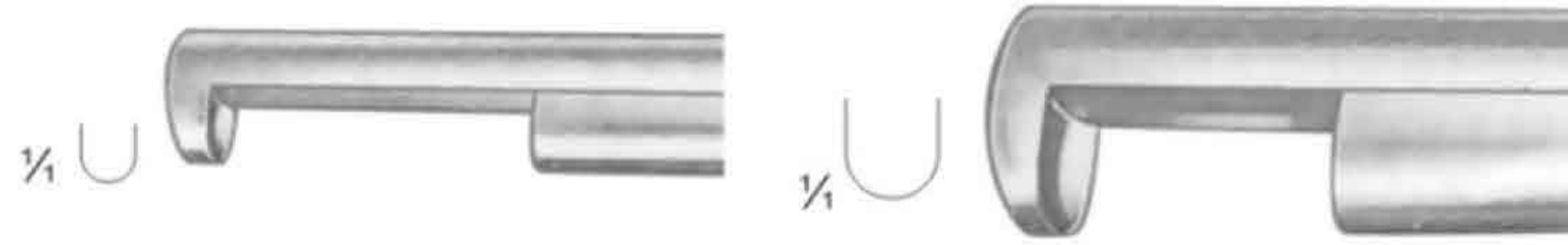
Length of shaft	150 mm 6"	150 mm 6"	200 mm 8"	200 mm 8"
Width of bite	3 mm	5 mm	3 mm	5 mm
Cat. Ref	SSC-41-11-86	SSC-41-11-87	SSC-41-11-88	SSC-41-11-89



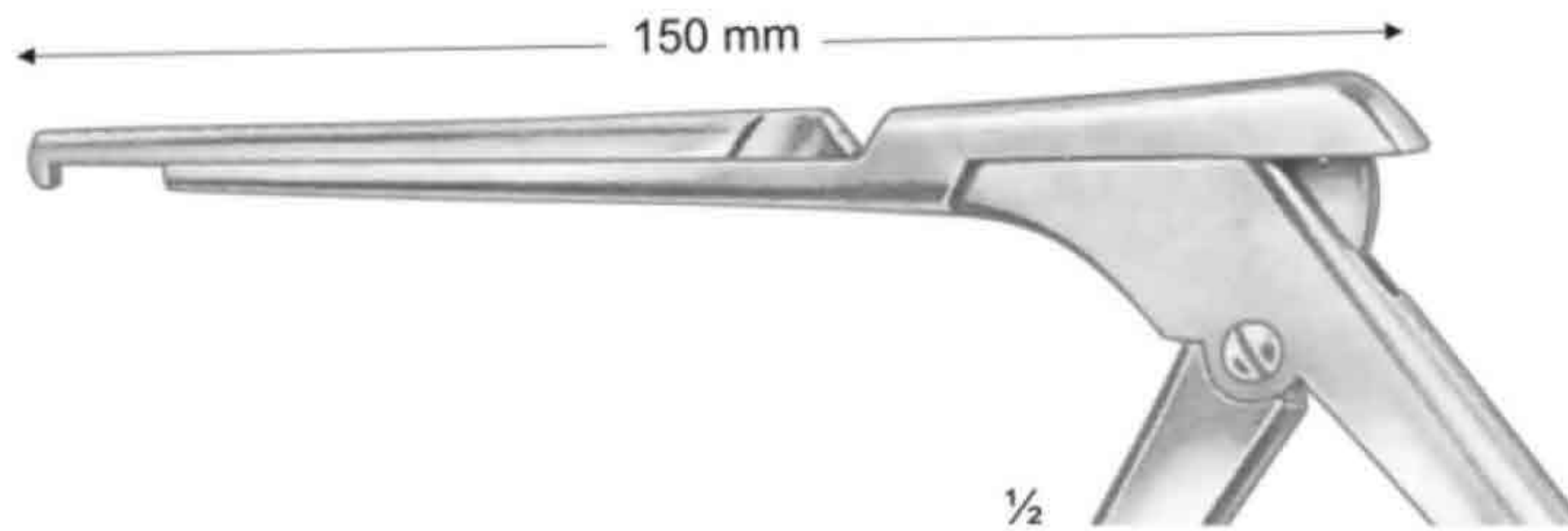
Colclough



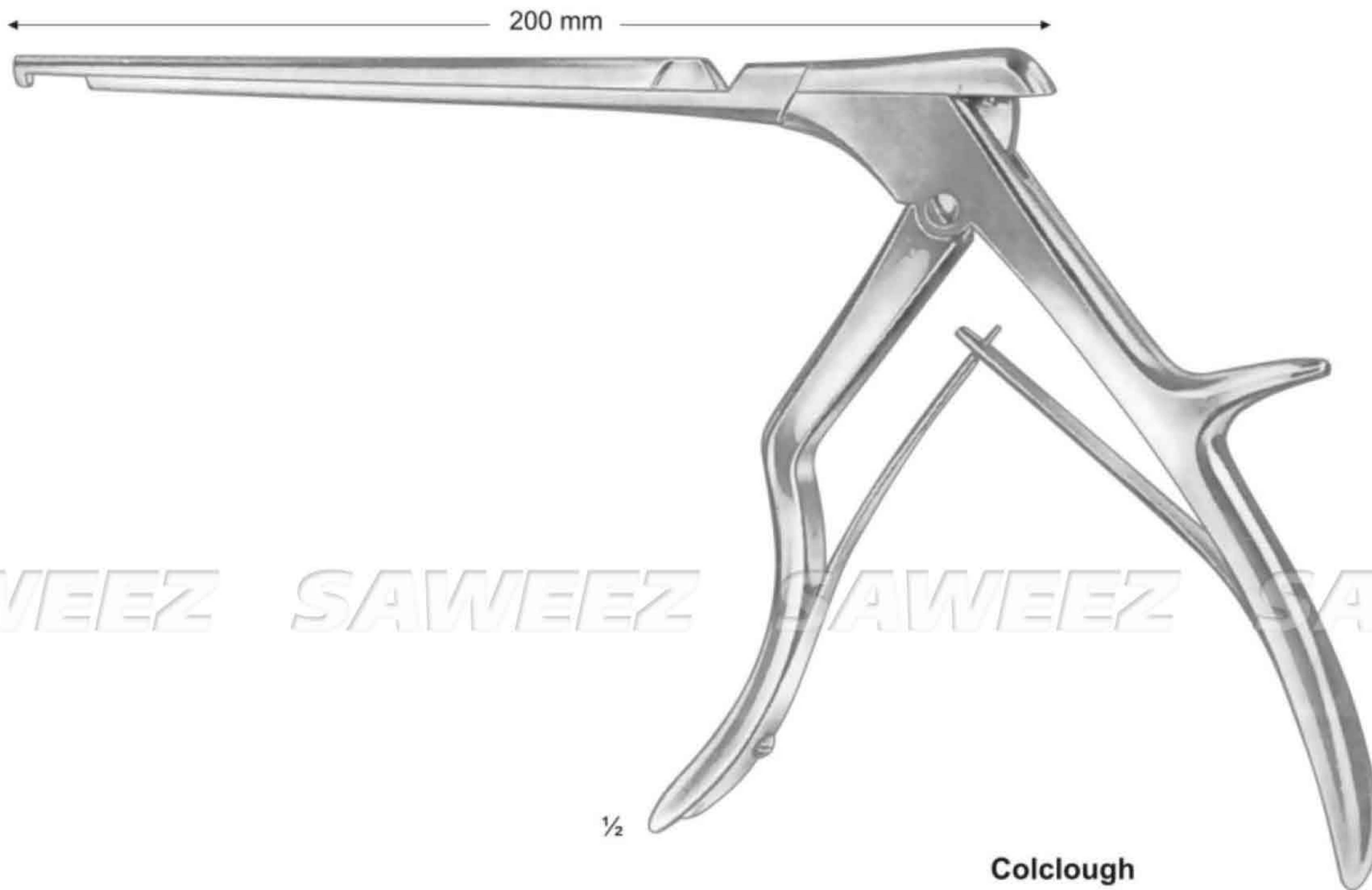
Cloward



Length of shaft	150 mm 6"	150 mm 6"	200 mm 8"	200 mm 8"
Width of bite	3 mm	5 mm	3 mm	5 mm
Cat. Ref	SSC-41-11-90	SSC-41-11-91	SSC-41-11-92	SSC-41-11-93



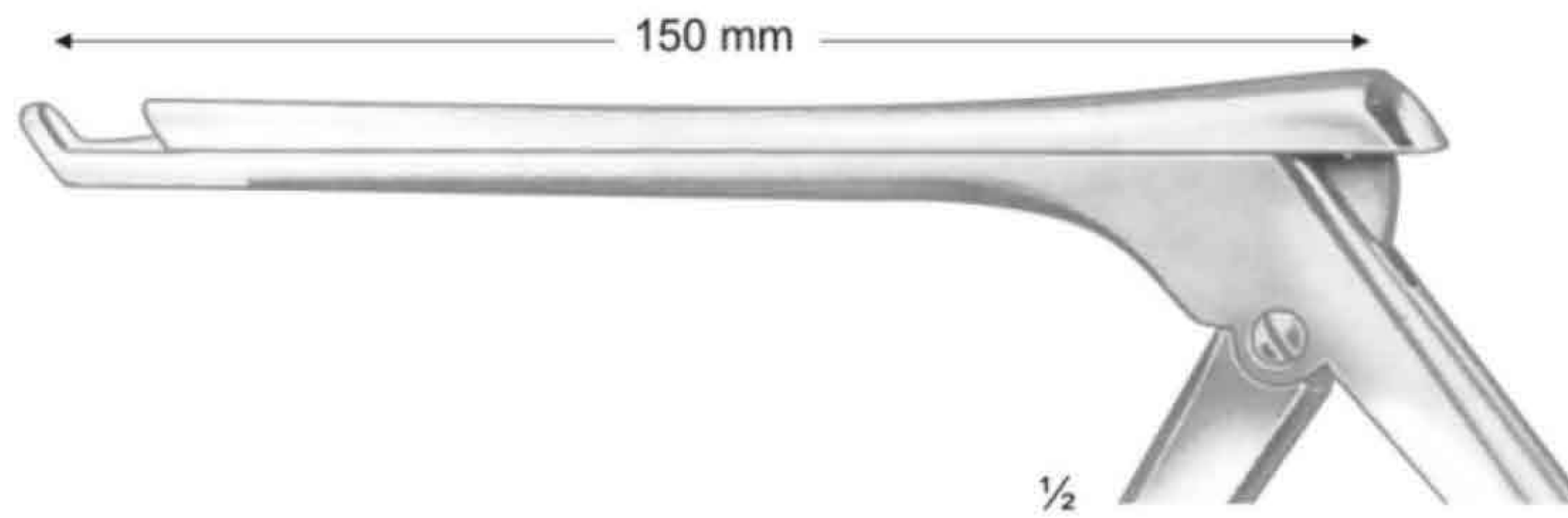
Colclough



Colclough



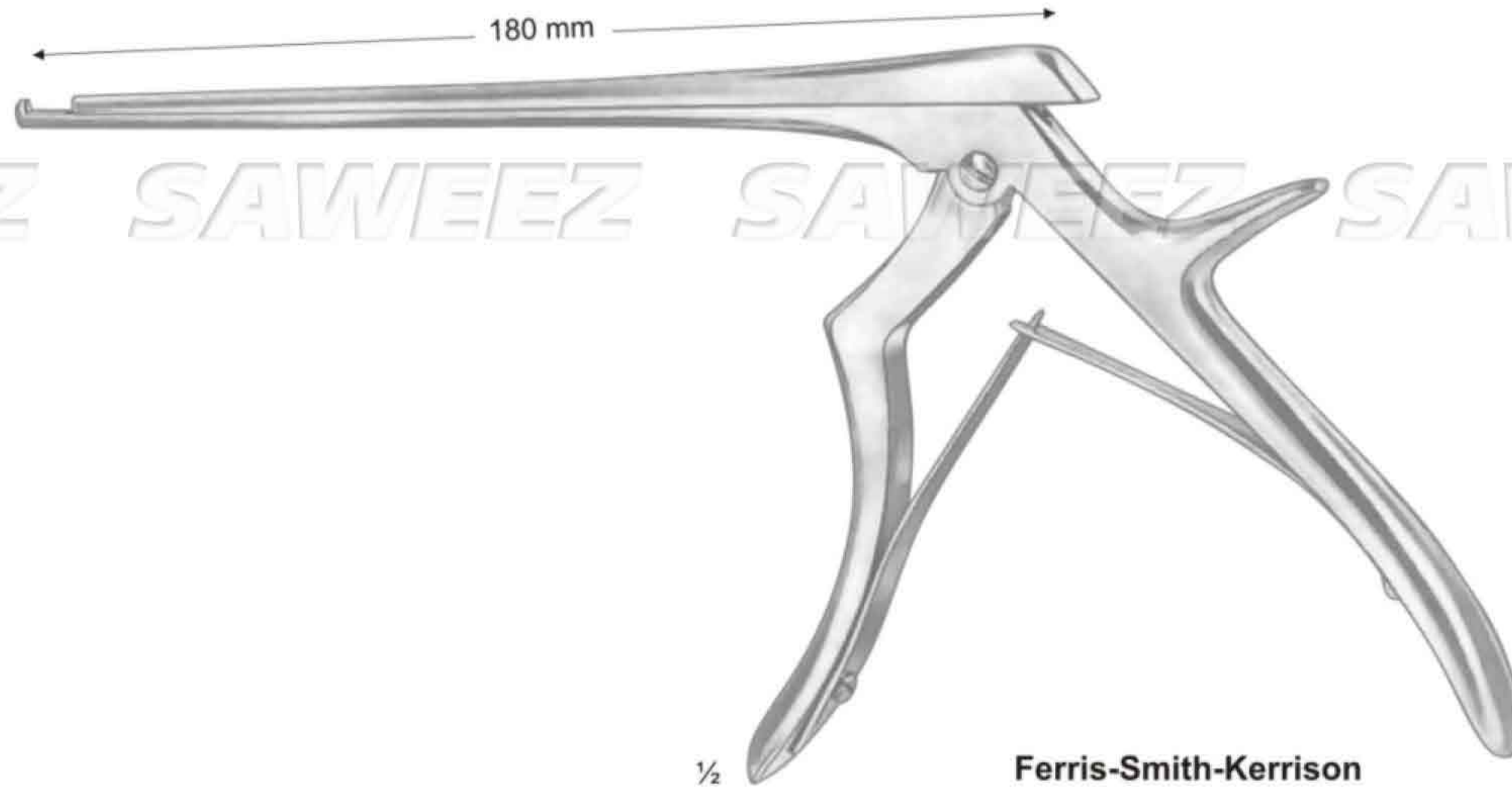
Length of shaft	150 mm 6"	150 mm 6"	200 mm 8"	200 mm 8"
Width of bite	3 mm	5 mm	3 mm	5 mm
Cat. Ref.	SSC-41-11-94	SSC-41-11-95	SSC-41-11-96	SSC-41-11-97



Colclough



Colclough (Richter)



1/2

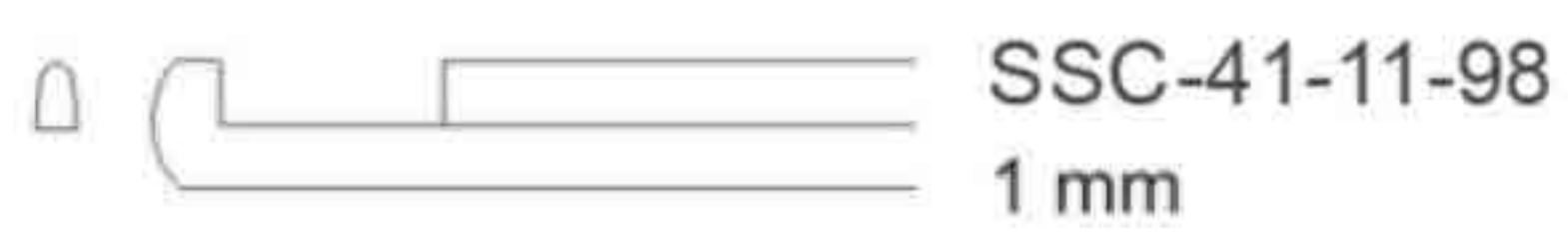
Ferris-Smith-Kerrison
18.0 / 7 cm shaft

SAWEEZ SAWEEZ SAWEEZ SAWEEZ

cutting upward

cutting downward

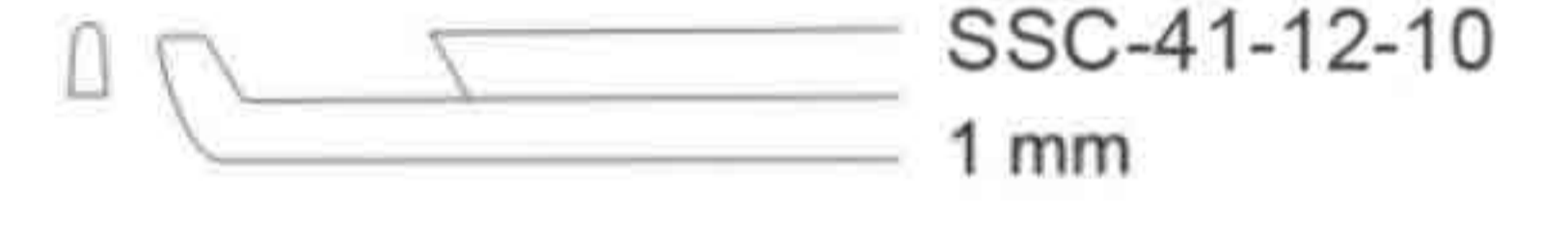
cutting 40° forward



SSC-41-11-98
1 mm



SSC-41-12-04
1 mm



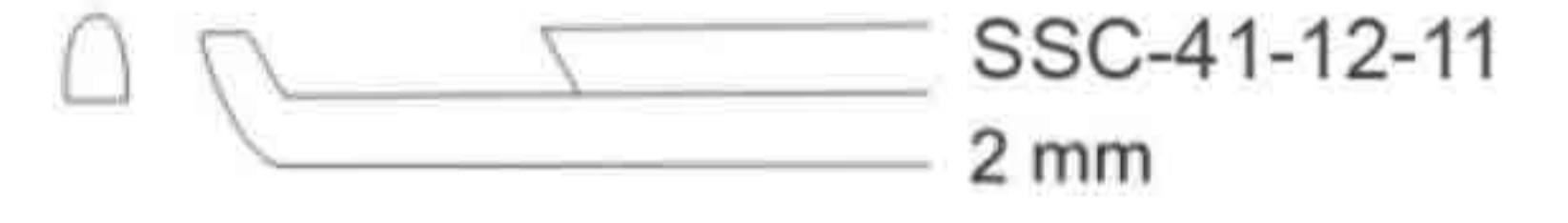
SSC-41-12-10
1 mm



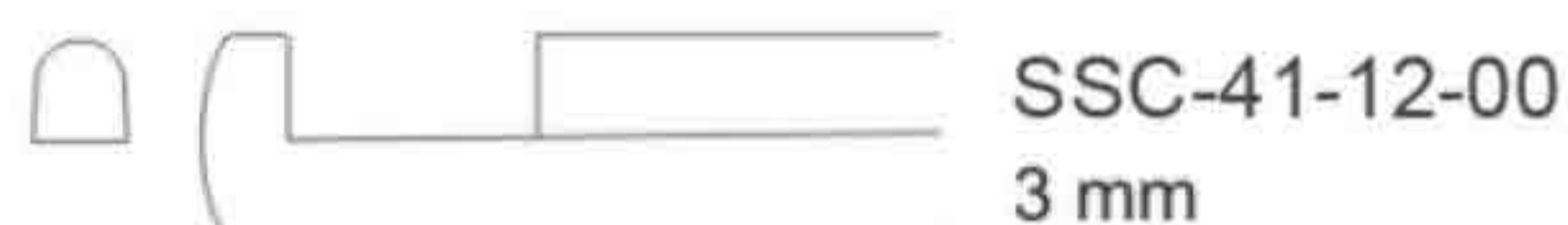
SSC-41-11-99
2 mm



SSC-41-12-05
2 mm



SSC-41-12-11
2 mm



SSC-41-12-00
3 mm



SSC-41-12-06
3 mm



SSC-41-12-12
3 mm



SSC-41-12-01
4 mm



SSC-41-12-07
4 mm



SSC-41-12-13
4 mm

SAWEEZ SAWEEZ SAWEEZ SAWEEZ



SSC-41-12-02
5 mm



SSC-41-12-08
5 mm



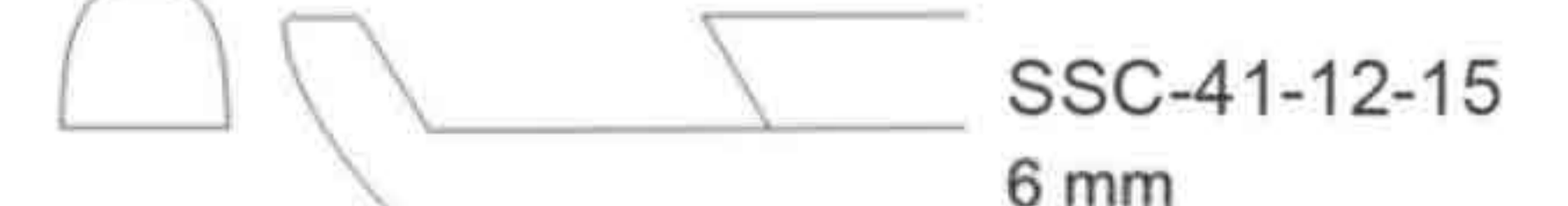
SSC-41-12-14
5 mm



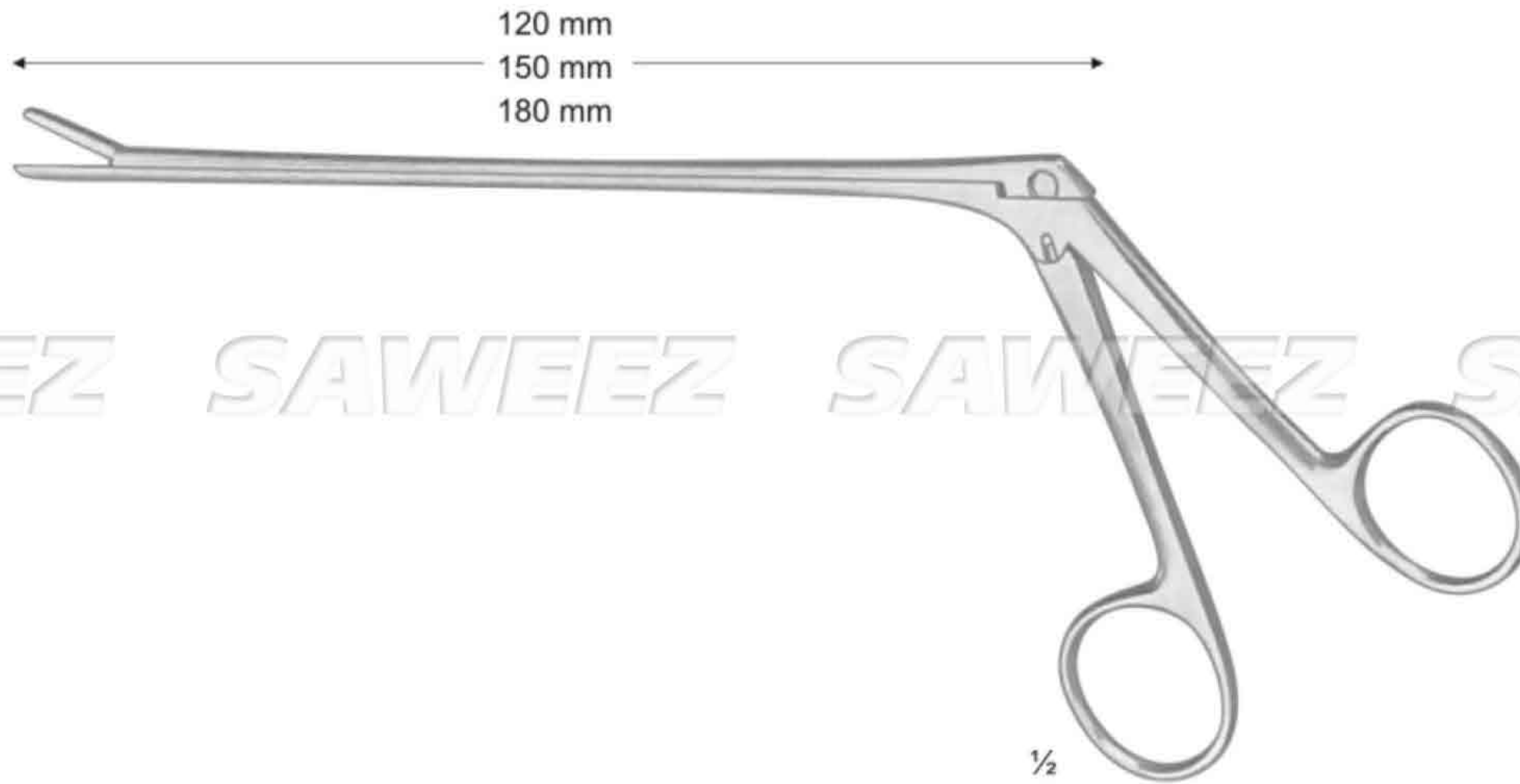
SSC-41-12-03
6 mm



SSC-41-12-09
6 mm

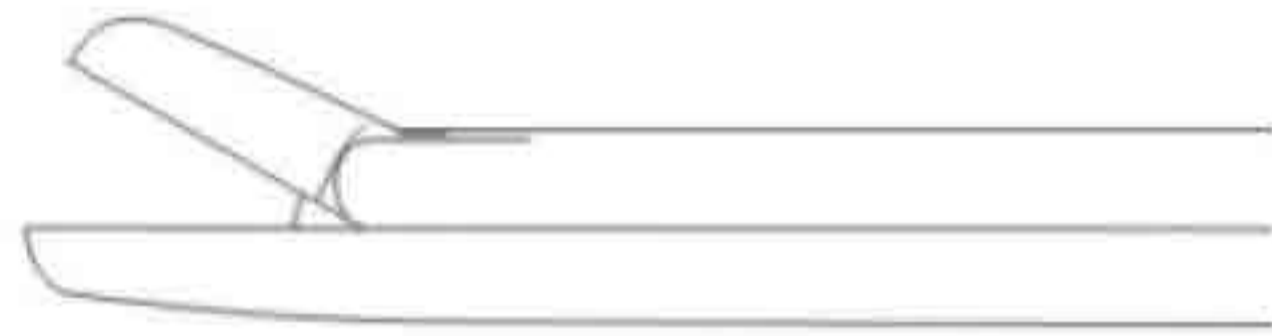
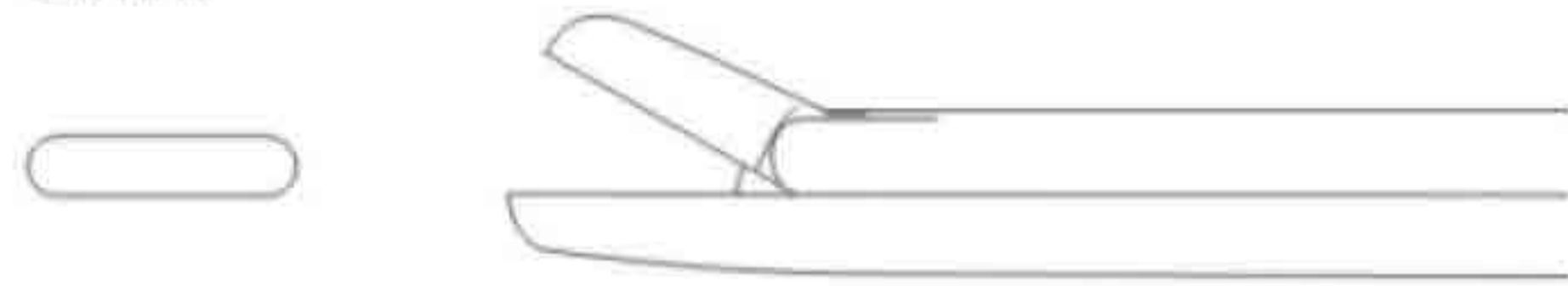


SSC-41-12-15
6 mm



SAWEEZ SAWEEZ SAWEEZ SAWEEZ

Cushing
2 mm



2 x 10 mm
SSC-41-12-16 - 12.0 cm
SSC-41-12-17 - 15.0 cm
SSC-41-12-18 - 18.0 cm



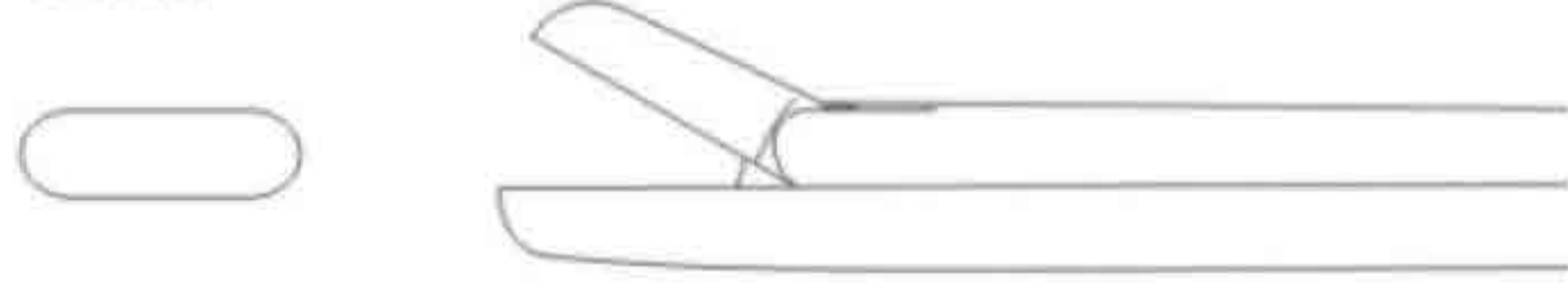
2 x 10 mm / 45°
SSC-41-12-19 - 12.0 cm
SSC-41-12-20 - 15.0 cm
SSC-41-12-21 - 18.0 cm



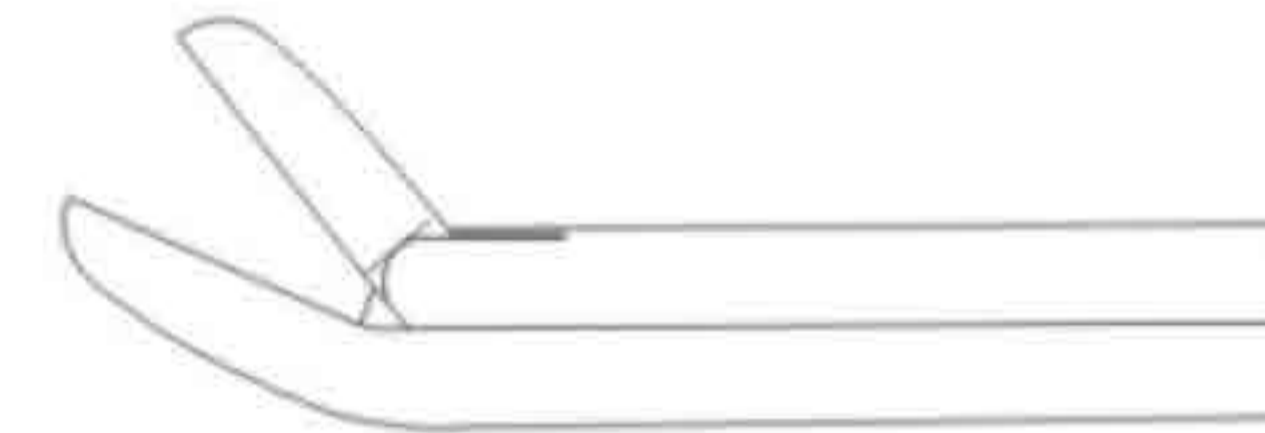
2 x 10 mm / 45°
SSC-41-12-22 - 12.0 cm
SSC-41-12-23 - 15.0 cm
SSC-41-12-24 - 18.0 cm

SAWEEZ SAWEEZ SAWEEZ SAWEEZ

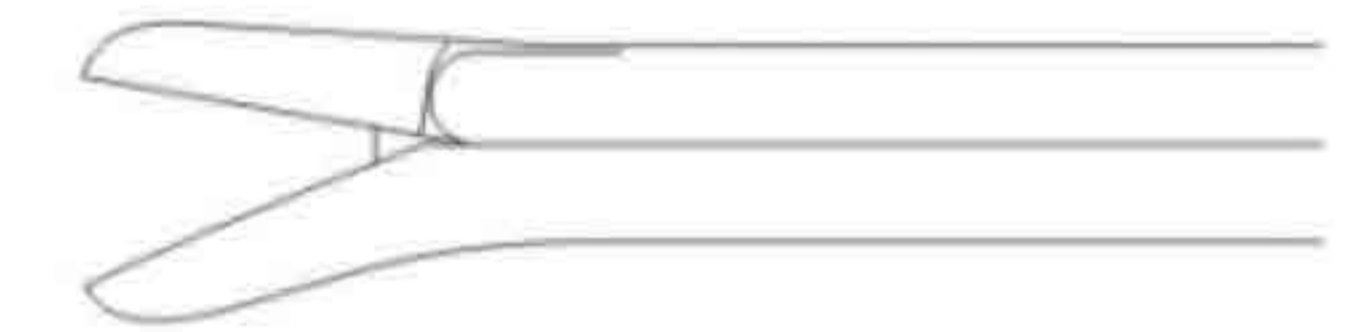
Love-Gruenwald
3 mm



3 x 10 mm
SSC-41-12-25 - 12.0 cm
SSC-41-12-26 - 15.0 cm
SSC-41-12-27 - 18.0 cm

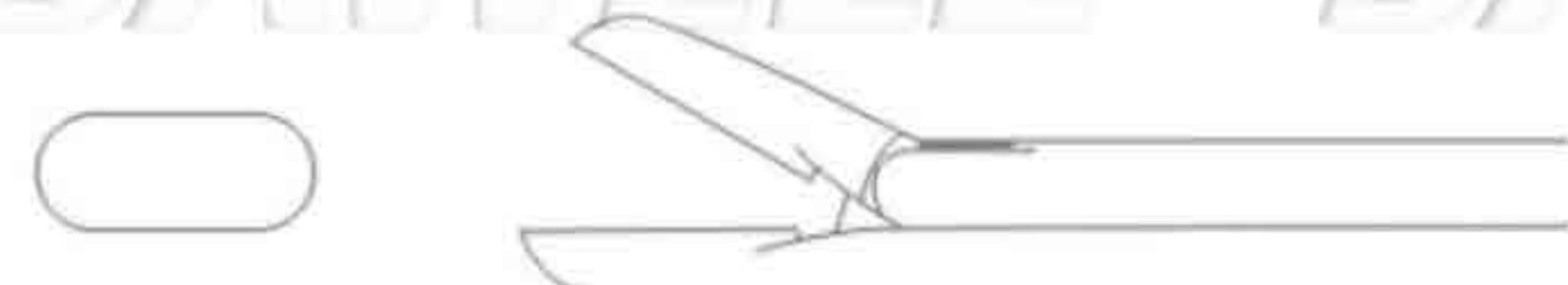


3 x 10 mm / 45°
SSC-41-12-28 - 12.0 cm
SSC-41-12-29 - 15.0 cm
SSC-41-12-30 - 18.0 cm



3 x 10 mm / 45°
SSC-41-12-31 - 12.0 cm
SSC-41-12-32 - 15.0 cm
SSC-41-12-33 - 18.0 cm

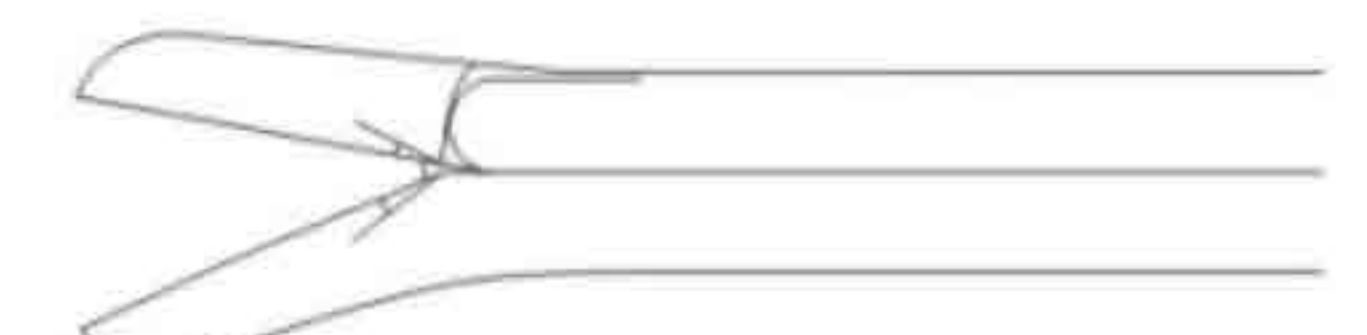
Spurling
4 mm



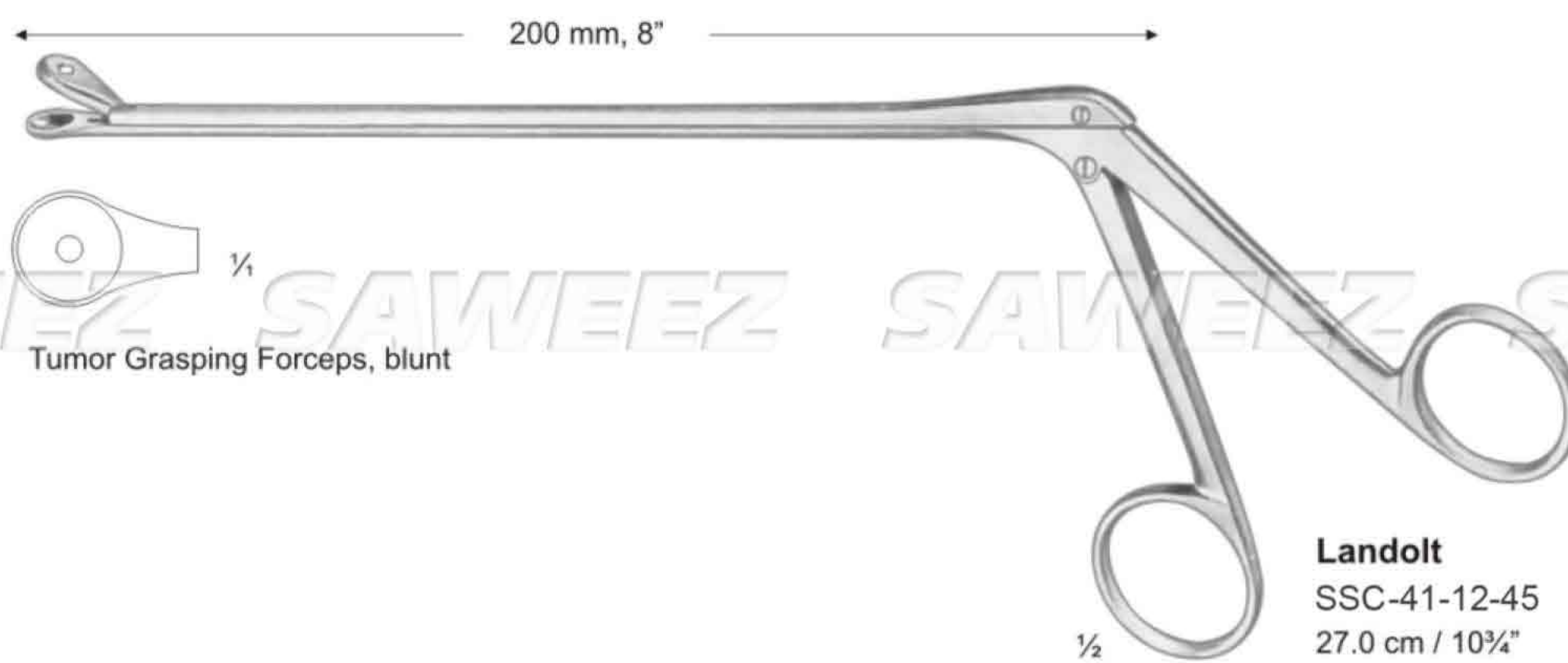
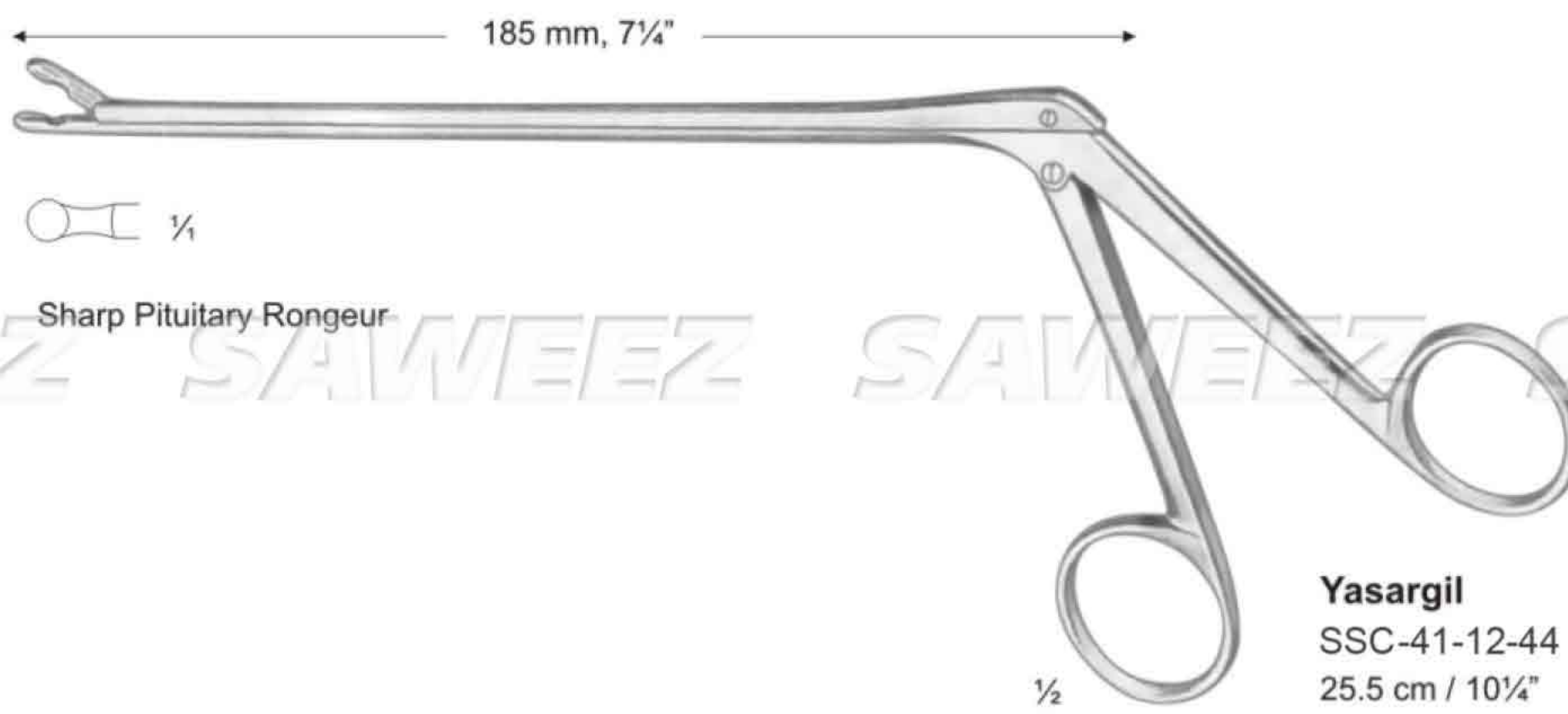
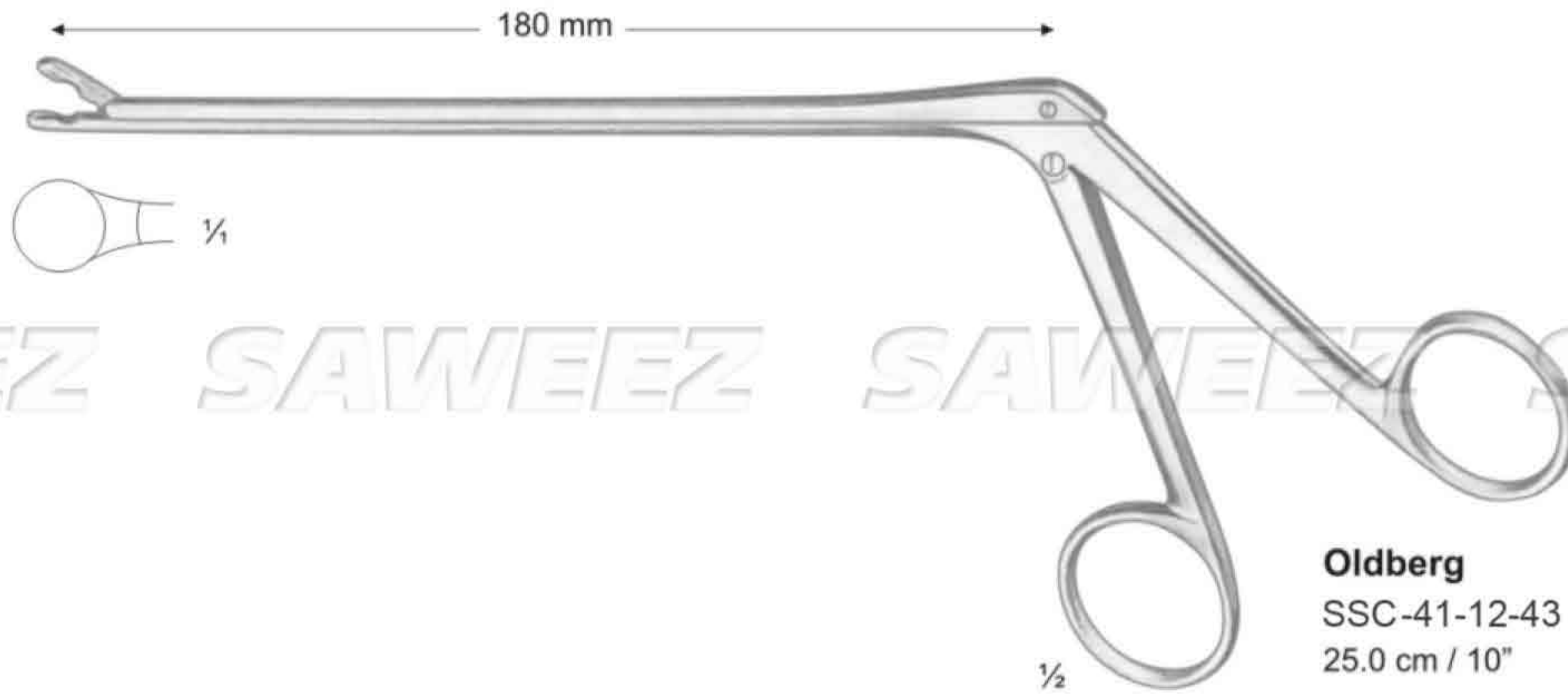
4 x 10 mm
SSC-41-12-34 - 12.0 cm
SSC-41-12-35 - 15.0 cm
SSC-41-12-36 - 18.0 cm



4 x 10 mm / 45°
SSC-41-12-37 - 12.0 cm
SSC-41-12-38 - 15.0 cm
SSC-41-12-39 - 18.0 cm



4 x 10 mm / 45°
SSC-41-12-40 - 12.0 cm
SSC-41-12-41 - 15.0 cm
SSC-41-12-42 - 18.0 cm

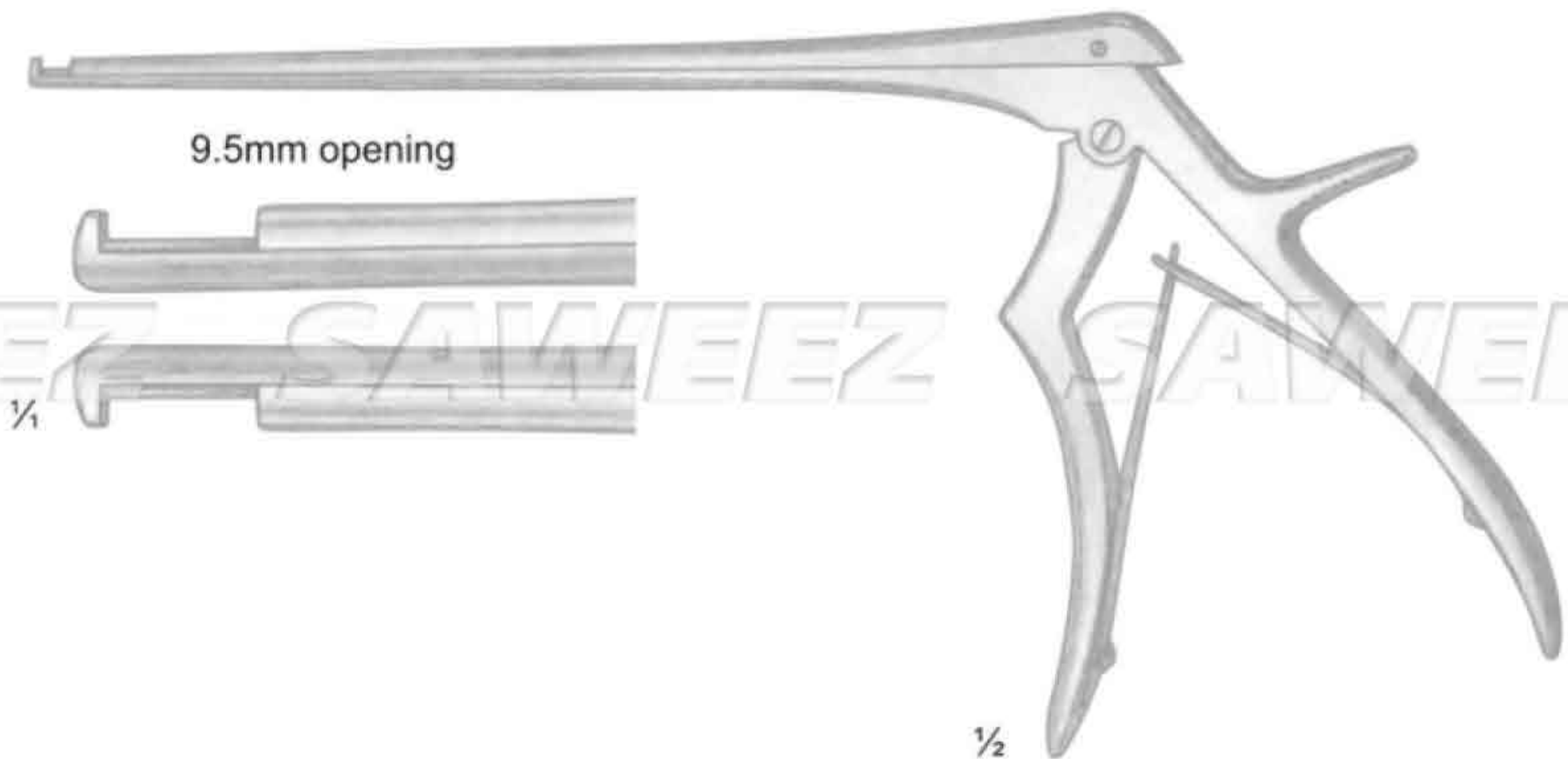




Kerrison Rongeurs

18.0 cm / 7" shaft

90° Up-bite	90° Down-bite	
SSC-41-12-46	SSC-41-12-51	2mm bite
SSC-41-12-47	SSC-41-12-52	3mm bite
SSC-41-12-48	SSC-41-12-53	4mm bite
SSC-41-12-49	SSC-41-12-54	5mm bite
SSC-41-12-50	SSC-41-12-55	6mm bite



Kerrison Rongeurs

20.0 cm / 8" shaft

90° Up-bite	90° Down-bite	
SSC-41-12-56	SSC-41-12-61	2mm bite
SSC-41-12-57	SSC-41-12-62	3mm bite
SSC-41-12-58	SSC-41-12-63	4mm bite
SSC-41-12-59	SSC-41-12-64	5mm bite
SSC-41-12-60	SSC-41-12-65	6mm bite

Kerrison Rongeurs

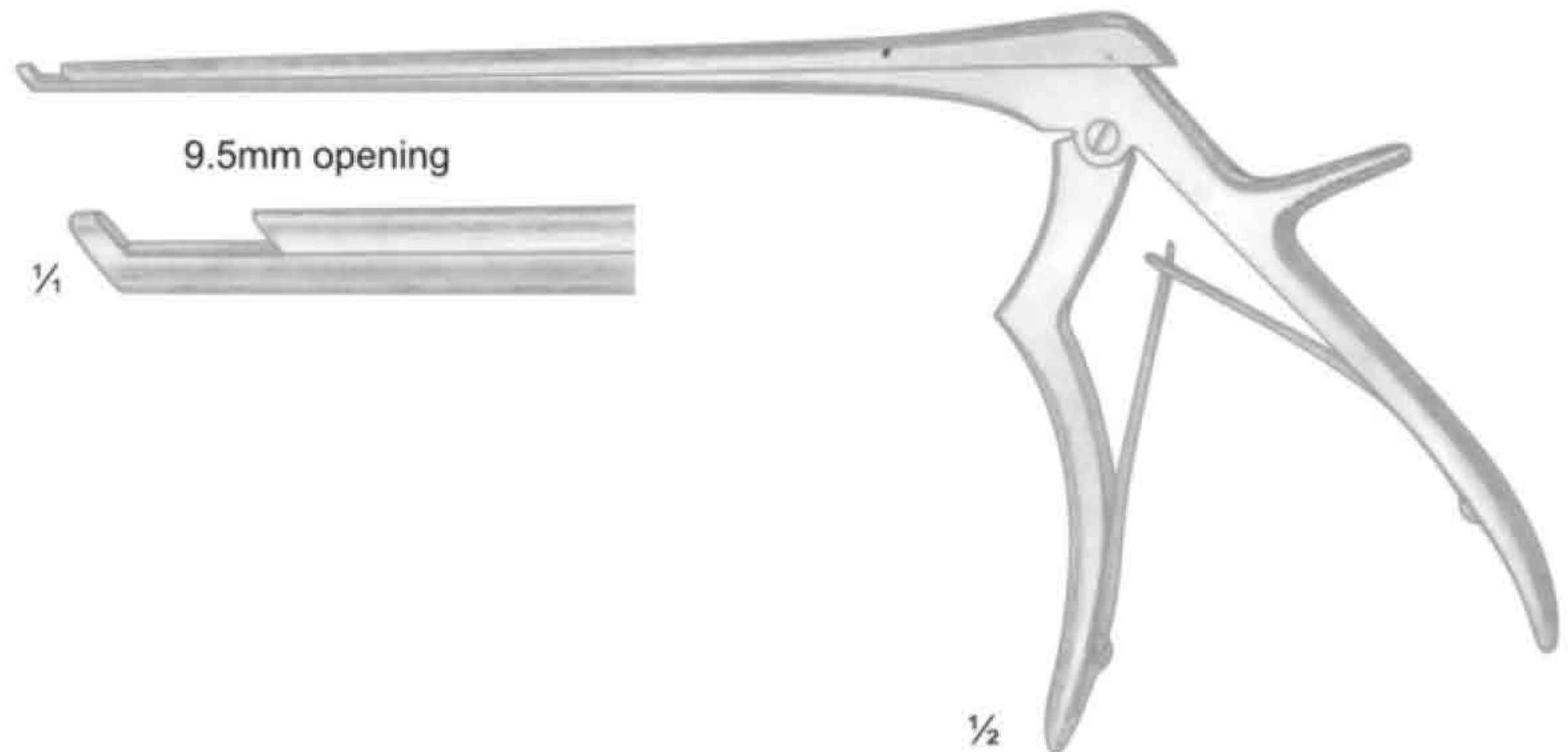
18.0 cm / 7" shaft, 40° forward-angle

SSC-41-12-66	2mm bite	SSC-41-12-69	5mm bite
SSC-41-12-67	3mm bite	SSC-41-12-70	6mm bite
SSC-41-12-68	4mm bite		

Kerrison Rongeurs

20.0 cm / 8" shaft, 40° forward-angle

SSC-41-12-71	2mm bite	SSC-41-12-74	5mm bite
SSC-41-12-72	3mm bite	SSC-41-12-75	6mm bite
SSC-41-12-73	4mm bite		



Kerrison Rongeurs

23.0 cm / 9" shaft, 40° forward-angle

SSC-41-12-76	2mm bite	SSC-41-12-79	5mm bite
SSC-41-12-77	3mm bite	SSC-41-12-80	6mm bite
SSC-41-12-78	4mm bite		

Kerrison Rongeurs

25.0 cm / 10" shaft, 40° forward-angle

SSC-41-12-81	2mm bite	SSC-41-12-84	5mm bite
SSC-41-12-82	3mm bite	SSC-41-12-85	6mm bite
SSC-41-12-83	4mm bite		

Kerrison Rongeurs

28.0 cm / 11" shaft, 40° forward-angle

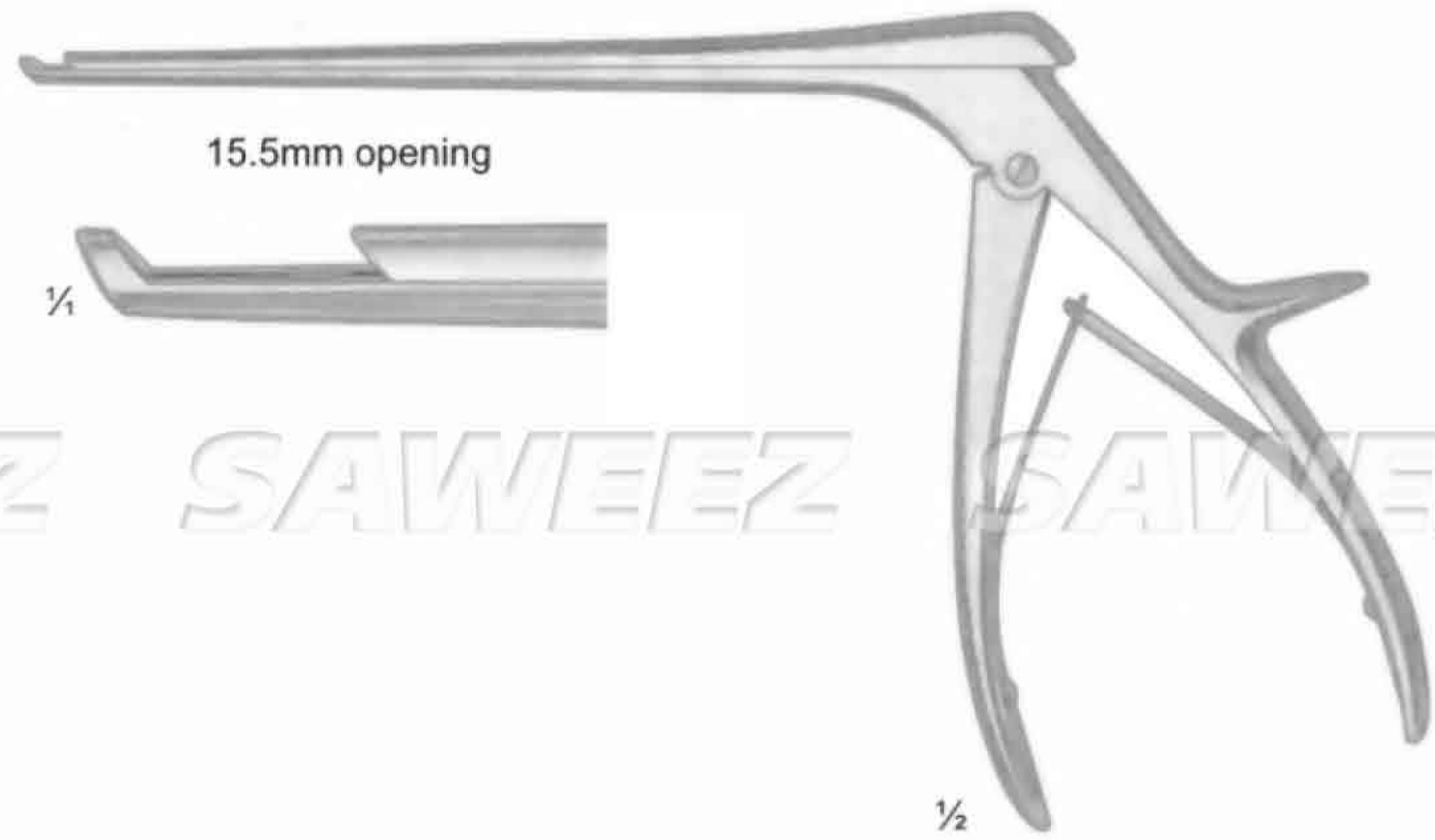
SSC-41-12-86	2mm bite	SSC-41-12-89	5mm bite
SSC-41-12-87	3mm bite	SSC-41-12-90	6mm bite
SSC-41-12-88	4mm bite		



Love-Kerrison Rongeurs

40° forward-angle

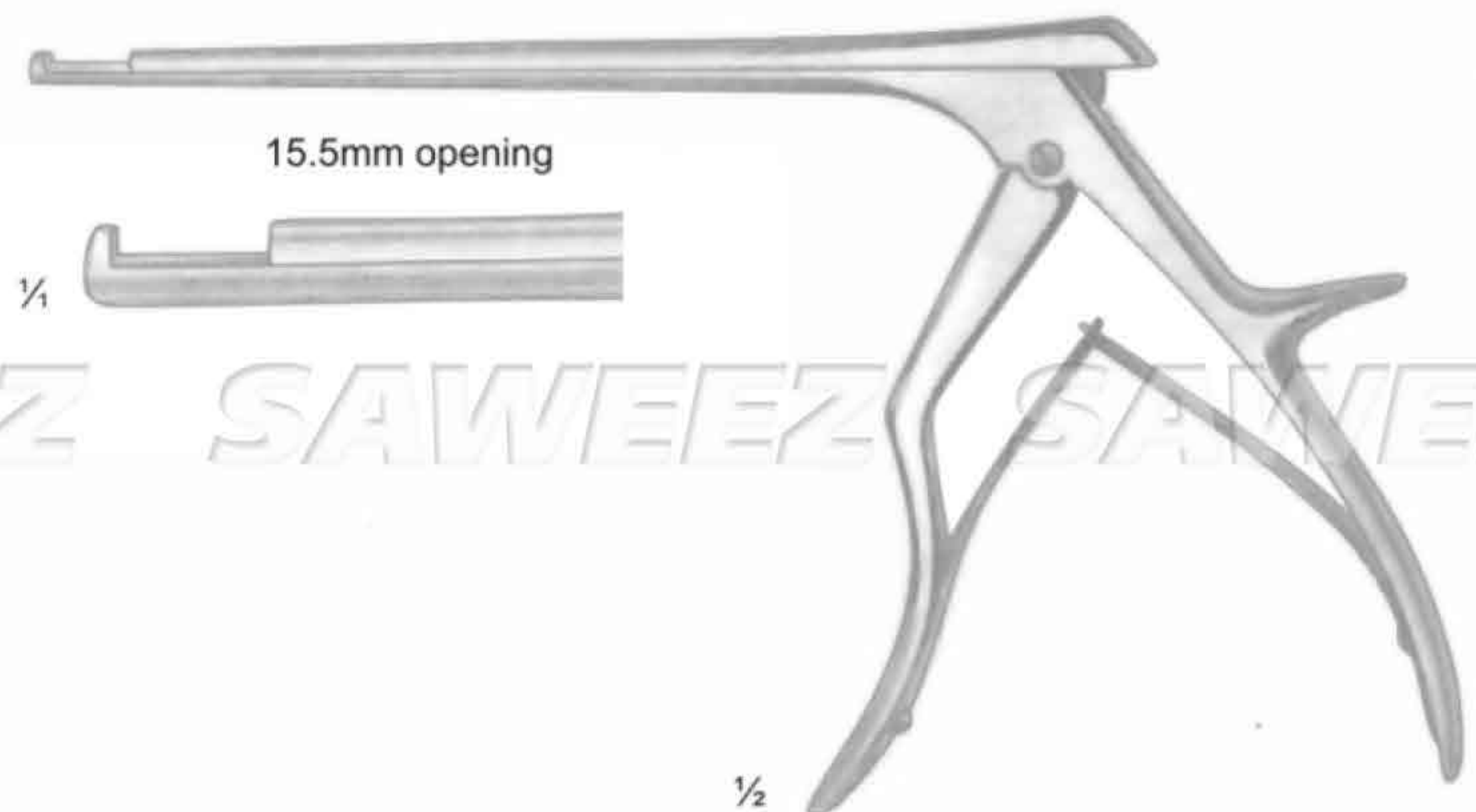
18.0 cm / 7" shaft	20.0 cm / 8" shaft	
SSC-41-12-91	SSC-41-12-96	2mm bite
SSC-41-12-92	SSC-41-12-97	3mm bite
SSC-41-12-93	SSC-41-12-98	4mm bite
SSC-41-12-94	SSC-41-12-99	5mm bite
SSC-41-12-95	SSC-41-13-00	6mm bite



Love-Kerrison Rongeurs

improved handle, 90° up-bite

18.0 cm / 7" shaft	20.0 cm / 8" shaft	
SSC-41-13-01	SSC-41-13-06	2mm bite
SSC-41-13-02	SSC-41-13-07	3mm bite
SSC-41-13-03	SSC-41-13-08	4mm bite
SSC-41-13-04	SSC-41-13-09	5mm bite
SSC-41-13-05	SSC-41-13-10	6mm bite



Love-Kerrison Rongeurs

improved handle, 40° forward-angle

18.0 cm / 7" shaft	20.0 cm / 8" shaft	23.0 cm / 9" shaft	28.0 cm / 11" shaft	
SSC-41-13-11	SSC-41-13-16	SSC-41-13-21	SSC-41-13-36	2mm bite
SSC-41-13-12	SSC-41-13-17	SSC-41-13-22	SSC-41-13-27	3mm bite
SSC-41-13-13	SSC-41-13-18	SSC-41-13-23	SSC-41-13-28	4mm bite
SSC-41-13-14	SSC-41-13-19	SSC-41-13-24	SSC-41-13-29	5mm bite
SSC-41-13-15	SSC-41-13-20	SSC-41-13-25	SSC-41-13-30	6mm bite

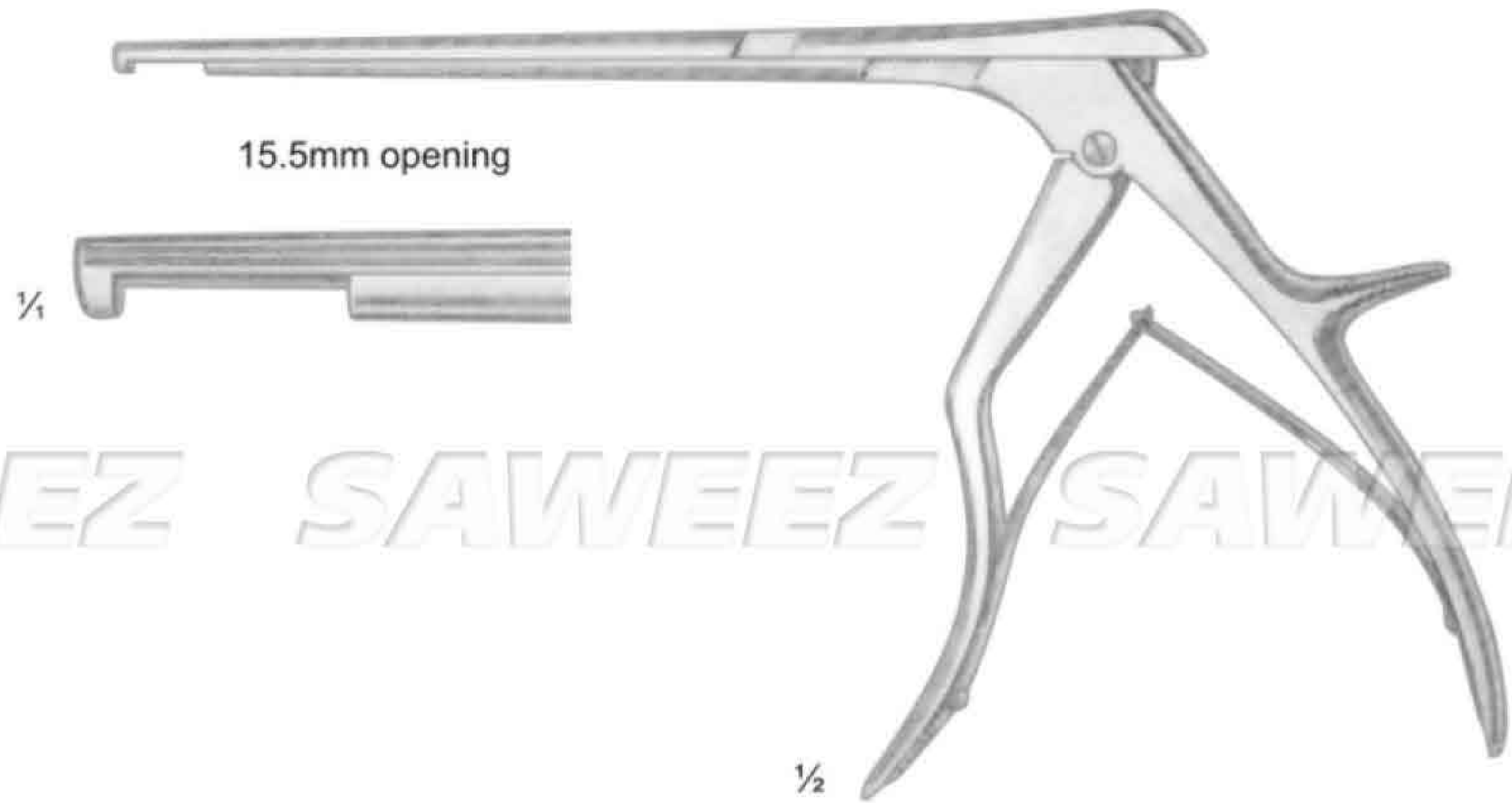




Love-Kerrison Rongeur

improved handle, 20.0 cm / 8" shaft,
90° down-bite

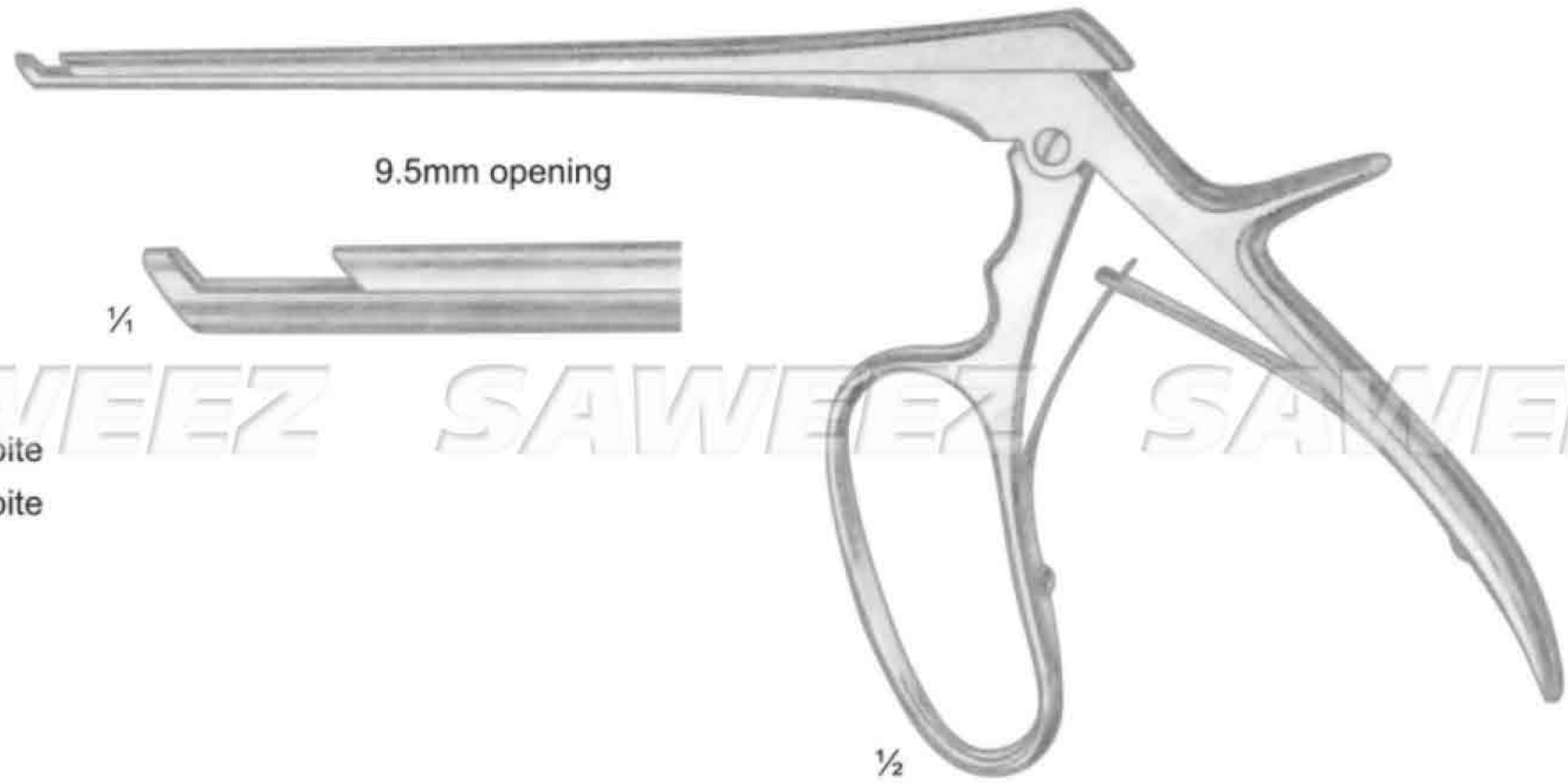
- SSC-41-13-31 2mm bite
- SSC-41-13-32 3mm bite
- SSC-41-13-32 4mm bite
- SSC-41-13-34 5mm bite
- SSC-41-13-35 6mm bite



Laminectomy Rongeur

40° forward-angle

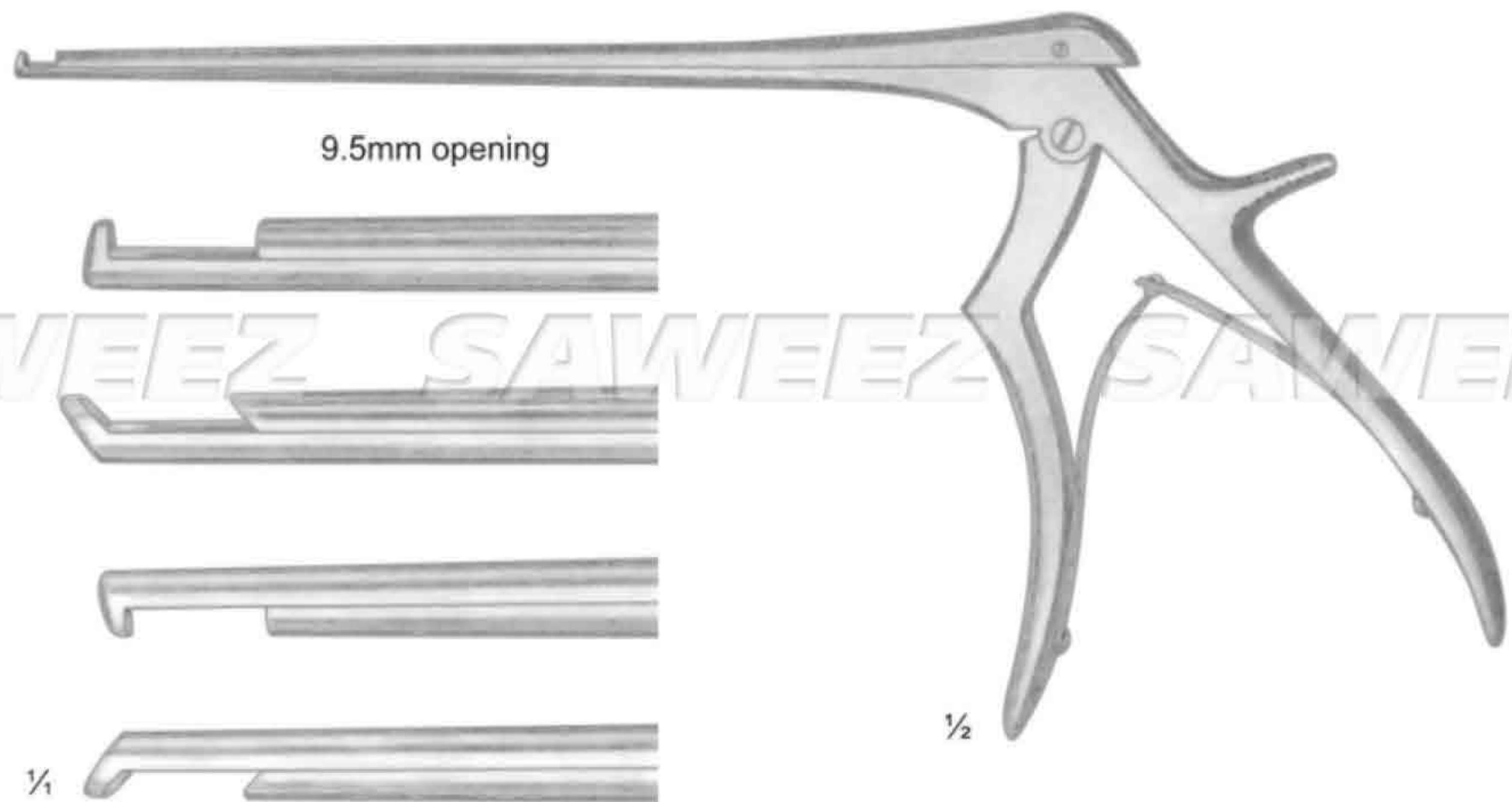
- | | | |
|------------------------|--------------------|----------|
| 17.5 cm / 6 7/8" shaft | 20.0 cm / 8" shaft | |
| SSC-41-13-36 | SSC-41-13-38 | 3mm bite |
| SSC-41-13-37 | SSC-41-13-39 | 5mm bite |



Sella Punches

18.0 cm / 7" shaft, 2mm bite

- SSC-41-13-40 90° down-bite
- SSC-41-13-41 40° down-bite
- SSC-41-13-42 90° down-bite
- SSC-41-13-43 40° down-bite

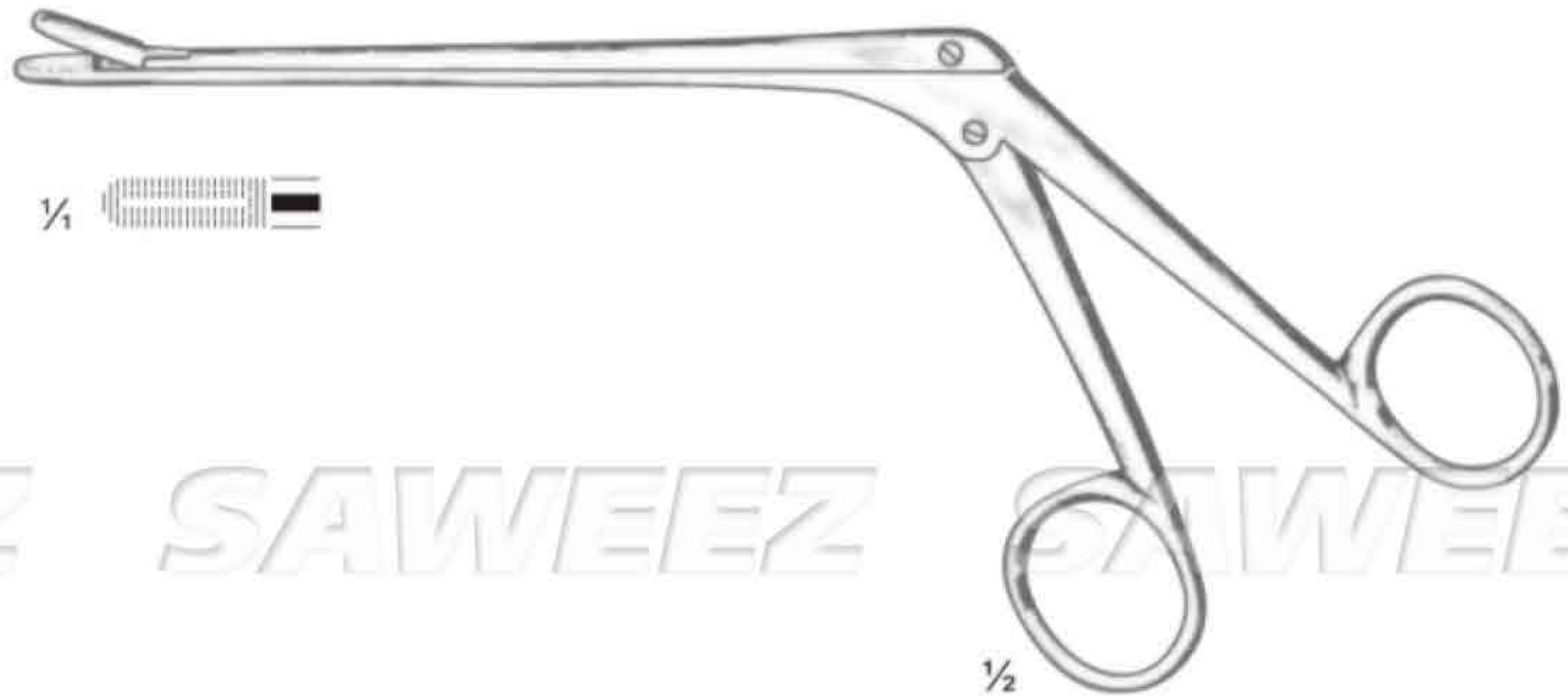




Schlesinger Rongeurs

13.0 cm / 5" shaft, serrated jaws, straight

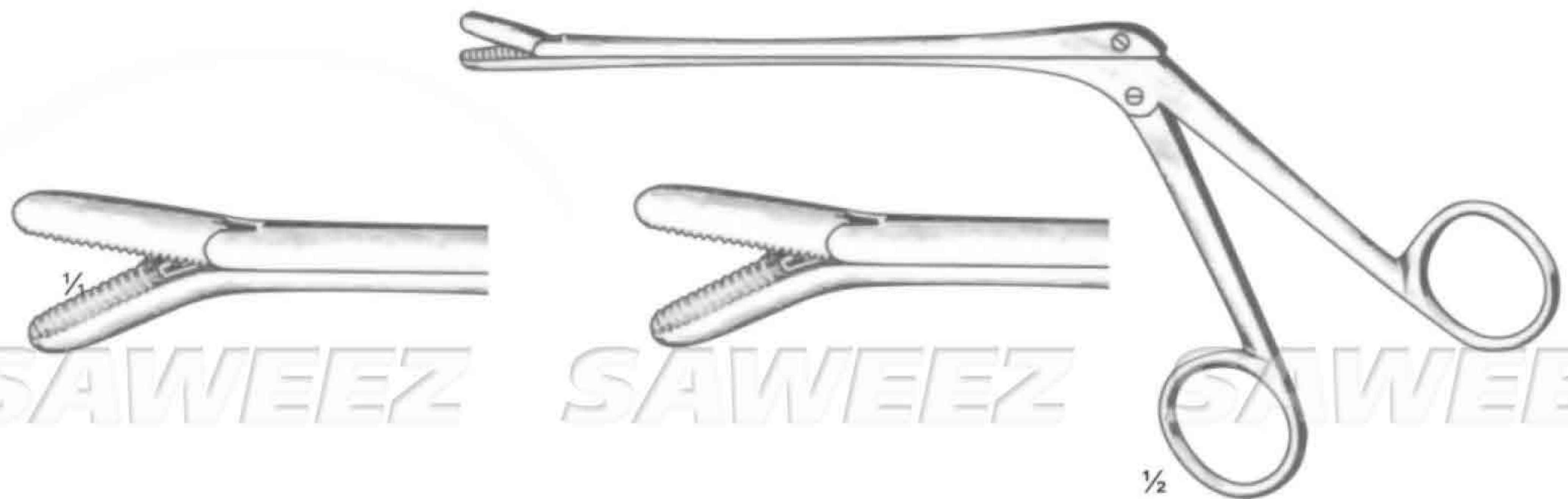
- SSC-41-13-44 2 x 10mm bite
- SSC-41-13-45 3 x 10mm bite
- SSC-41-13-46 4 x 10mm bite
- SSC-41-13-47 3 x 10mm bite, up angled



Special Model

13.0 cm / 5" shaft, serrated jaws, 6 x 10mm bite

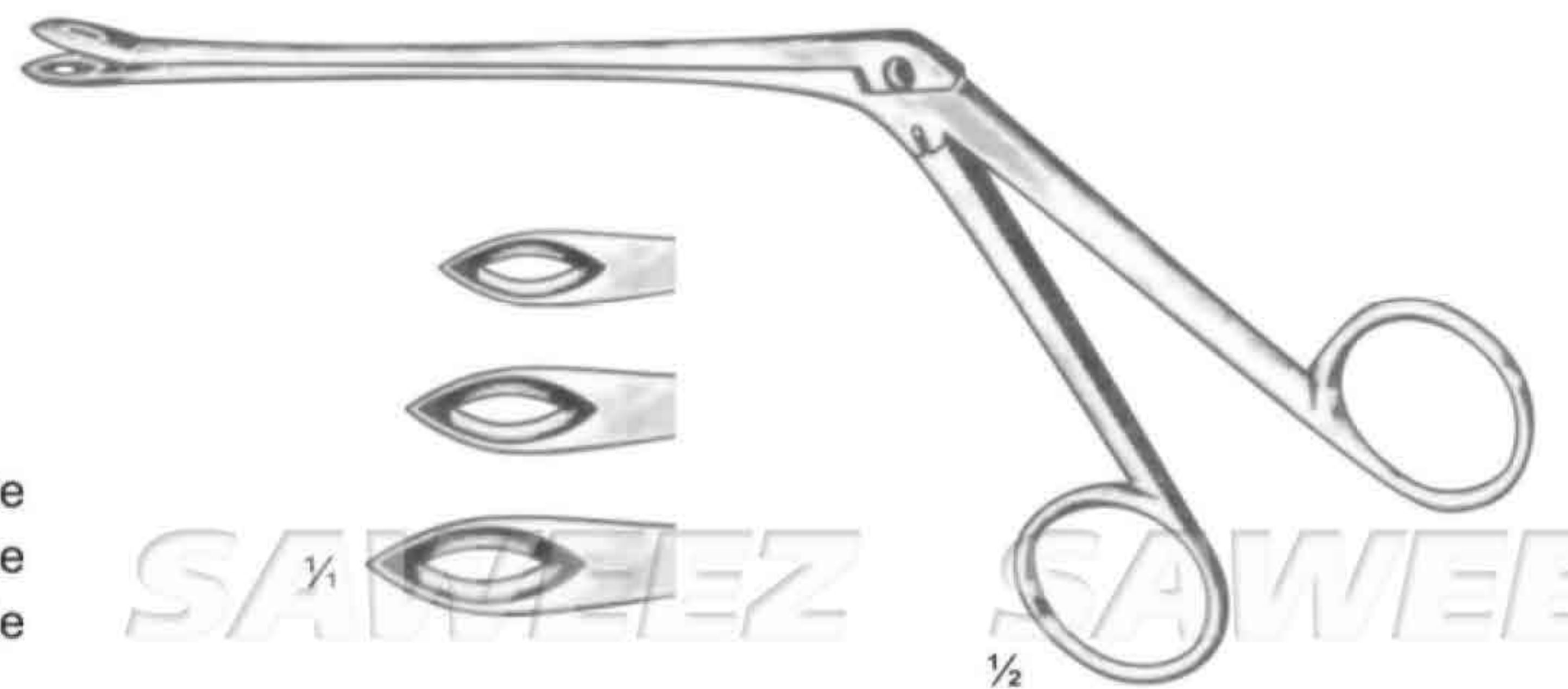
- SSC-41-13-48 Straight
- SSC-41-13-49 Up-angled
- SSC-41-13-50 Down-angled



Wilde Rongeurs

fenestrated jaws straight

- | | | | |
|---------------------|--------------------|--------------------|----------|
| 14.0 cm / 5½" shaft | 18.0 cm / 7" shaft | 23.0 cm / 9" shaft | |
| SSC-41-13-51 | SSC-41-13-54 | SSC-41-13-57 | 4mm bite |
| SSC-41-13-52 | SSC-41-13-55 | SSC-41-13-58 | 5mm bite |
| SSC-41-13-53 | SSC-41-13-56 | SSC-41-13-59 | 6mm bite |



Wilde Rongeurs

SSC-41-13-60
fenestrated jaws, up-angled
10.8 cm / 4¼" shaft, 5mm bite





Jackson Rongeurs

18.0 cm / 7" shaft, fenestrated jaws

SSC-41-13-61 4 x 8mm bite, 70° up-angled



SAWEEZ SAWEEZ SAWEEZ SAWEEZ

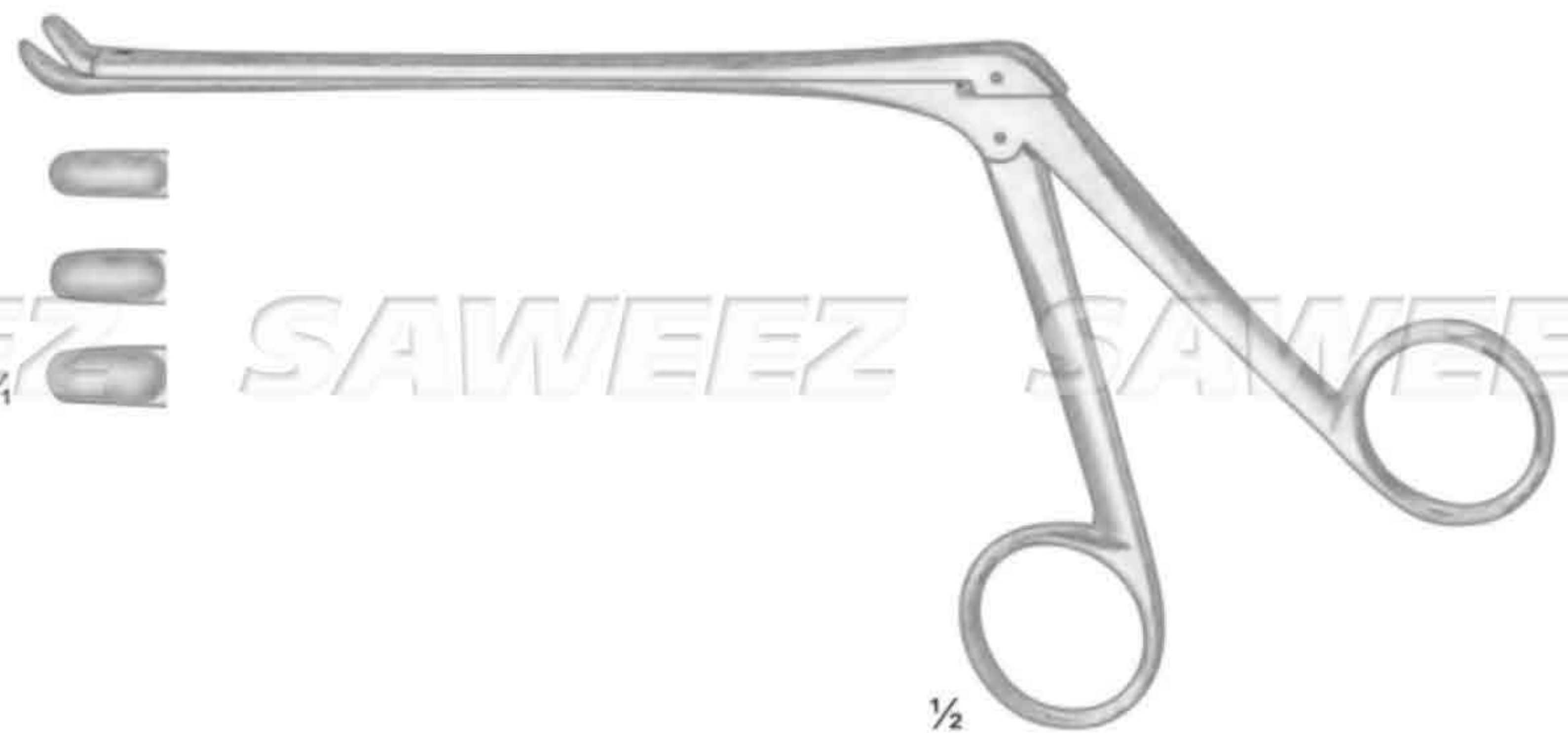
Peapod (Bead-Type) Forceps

14.0 cm / 5 1/2" shaft, 45° up-angled

SSC-41-13-62 2.3 x 7mm bite

SSC-41-13-63 2.7 x 7mm bite

SSC-41-13-64 3.2 x 7mm bite

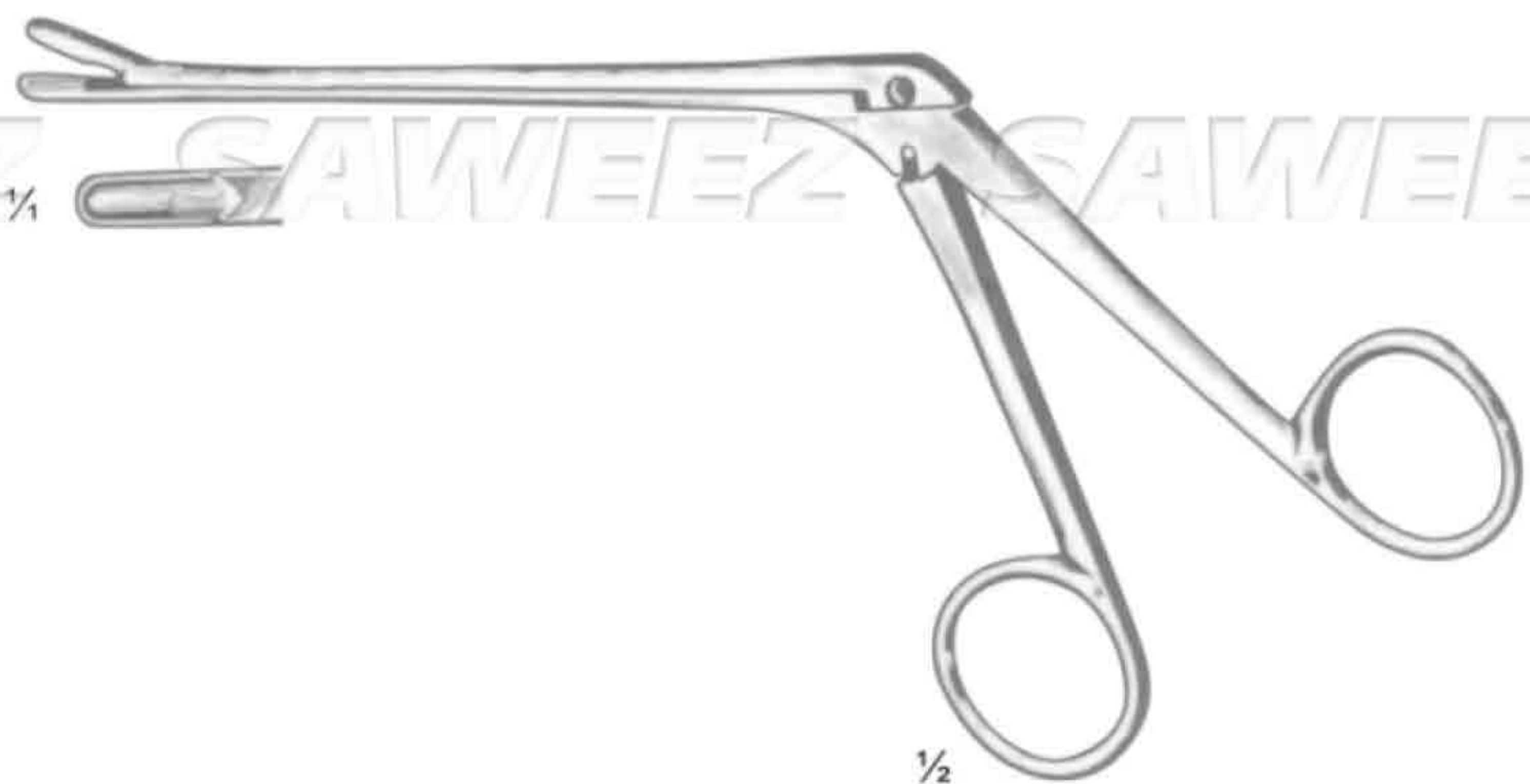


SAWEEZ SAWEEZ SAWEEZ SAWEEZ

Takahashi Rongeur

SSC-41-13-65

13.0 cm / 5" shaft, 4 x 10mm bite



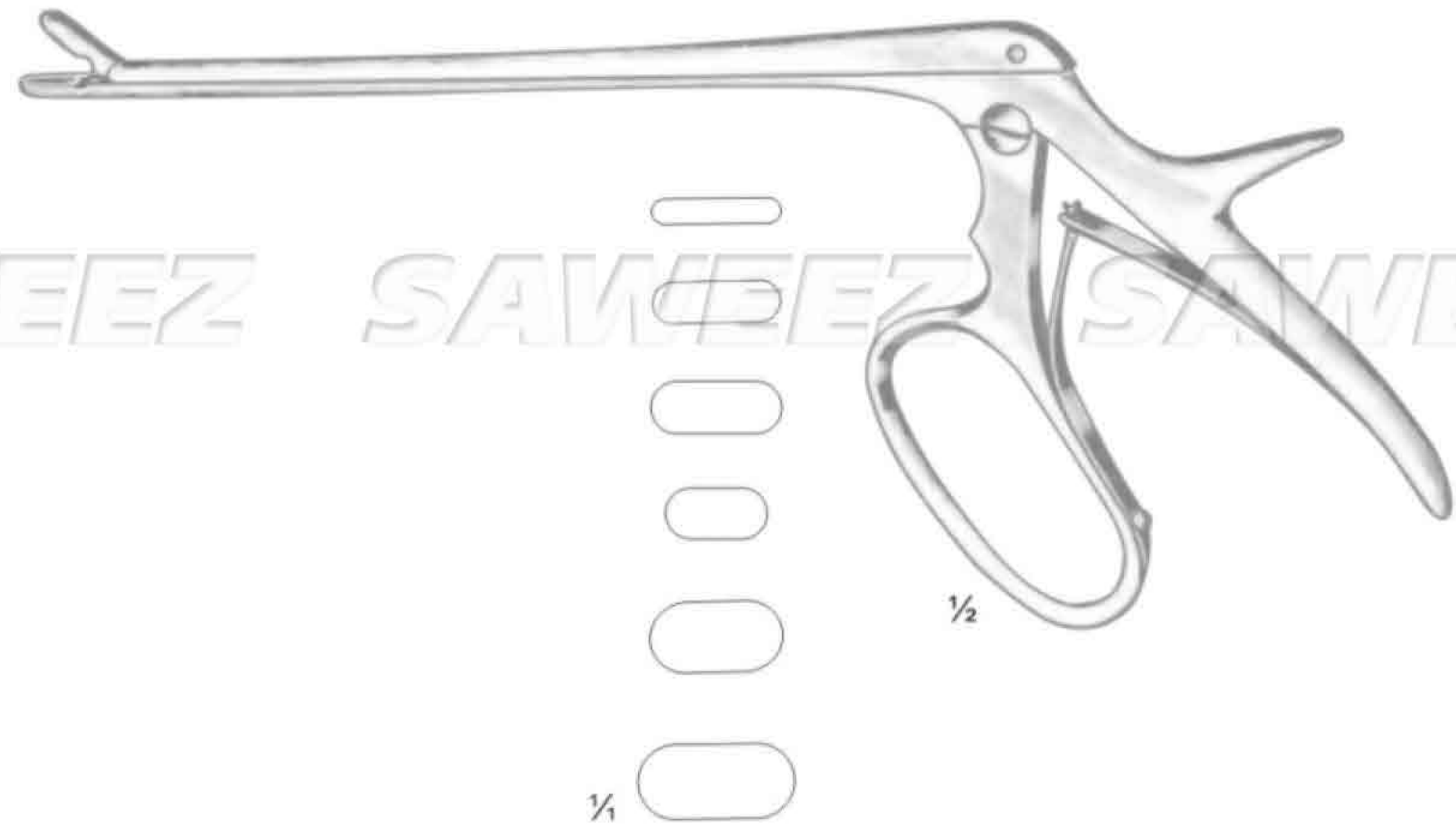
SAWEEZ SAWEEZ SAWEEZ SAWEEZ



Ferris-Smith Cup Jaw Rongeurs

18.0 cm / 7" shaft, Straight

- SSC-41-13-66 2 x 10mm bite
- SSC-41-13-67 3 x 10mm bite
- SSC-41-13-68 4 x 10mm bite
- SSC-41-13-69 4 x 8mm bite
- SSC-41-13-70 6 x 10mm bite
- SSC-41-13-71 6 x 12mm bite



Ferris-Smith Cup Jaw Rongeurs

18.0 cm / 7" shaft, up-angled

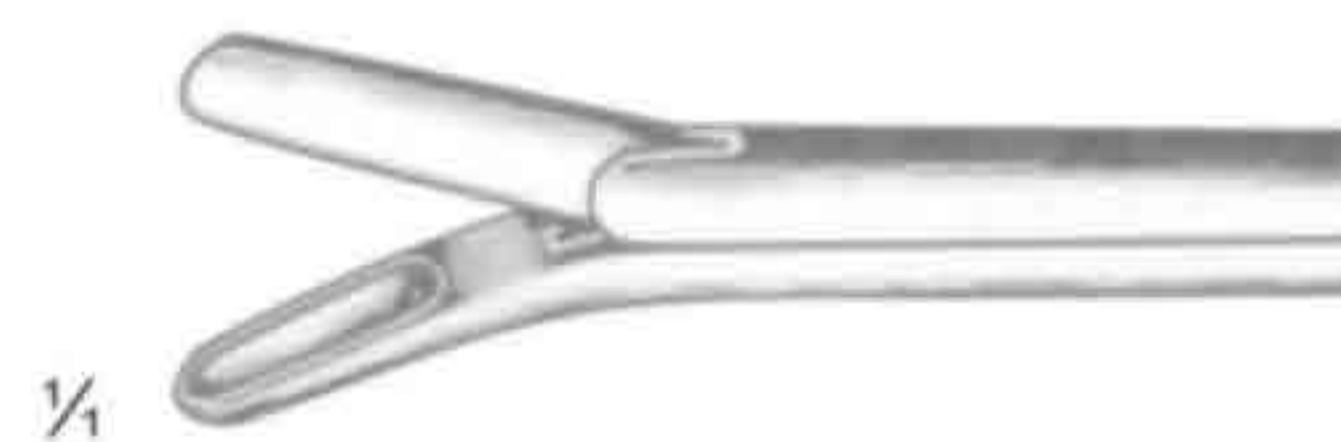
- SSC-41-13-72 2 x 10mm bite
- SSC-41-13-73 3 x 10mm bite
- SSC-41-13-74 4 x 10mm bite
- SSC-41-13-75 6 x 10mm bite



Ferris-Smith Cup Jaw Rongeurs

18.0 cm / 7" shaft, down-angled

- SSC-41-13-76 2 x 10mm bite
- SSC-41-13-77 3 x 10mm bite
- SSC-41-13-78 4 x 10mm bite
- SSC-41-13-79 6 x 10mm bite



Stookey Cranial Rongeur

SSC-41-13-80

19.0 cm / 7 1/2" 3mm bite





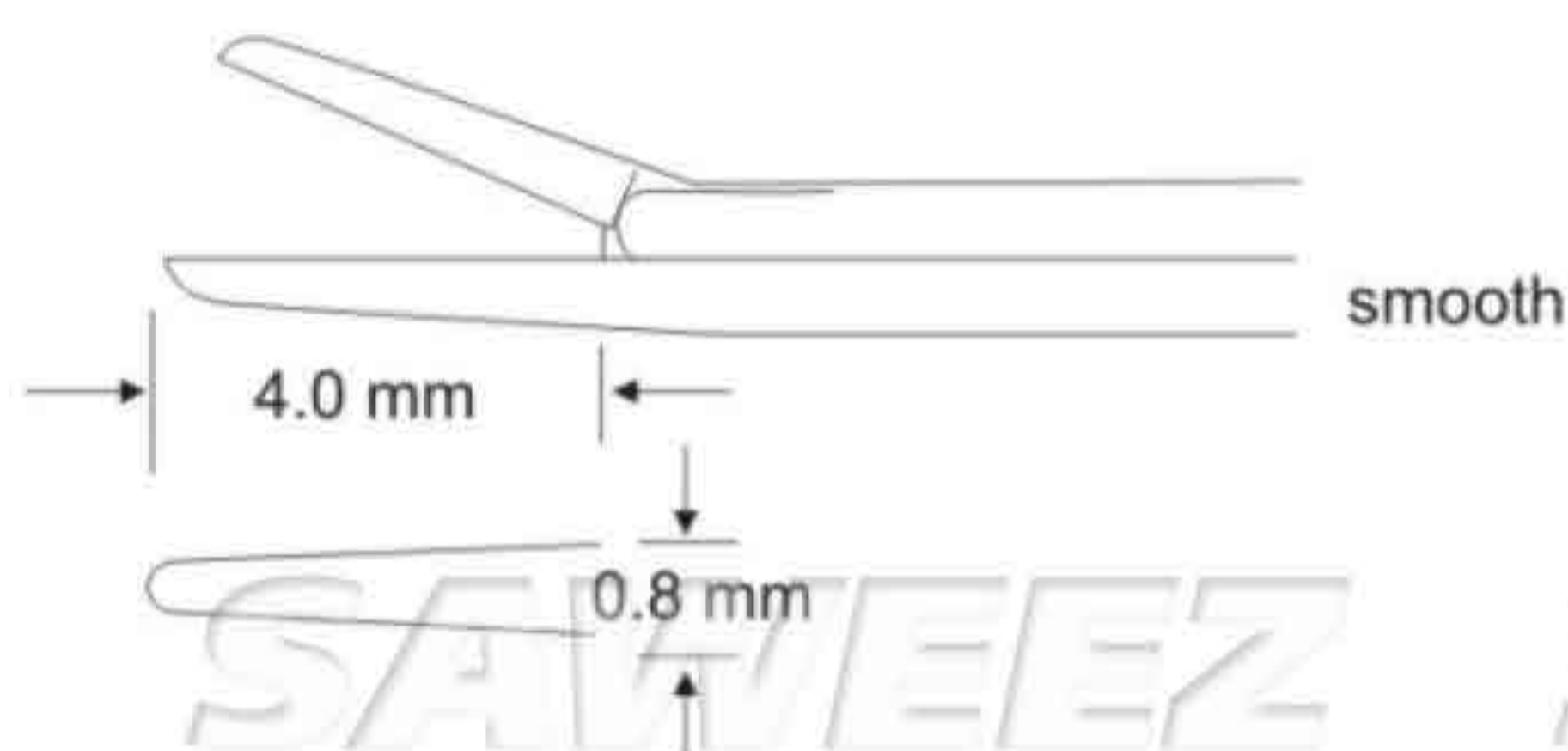
Brain Leyla Retractor Double
SSC-41-13-81



Brain Leyla Retractor Single
SSC-41-13-82



80 mm



smooth

4.0 mm

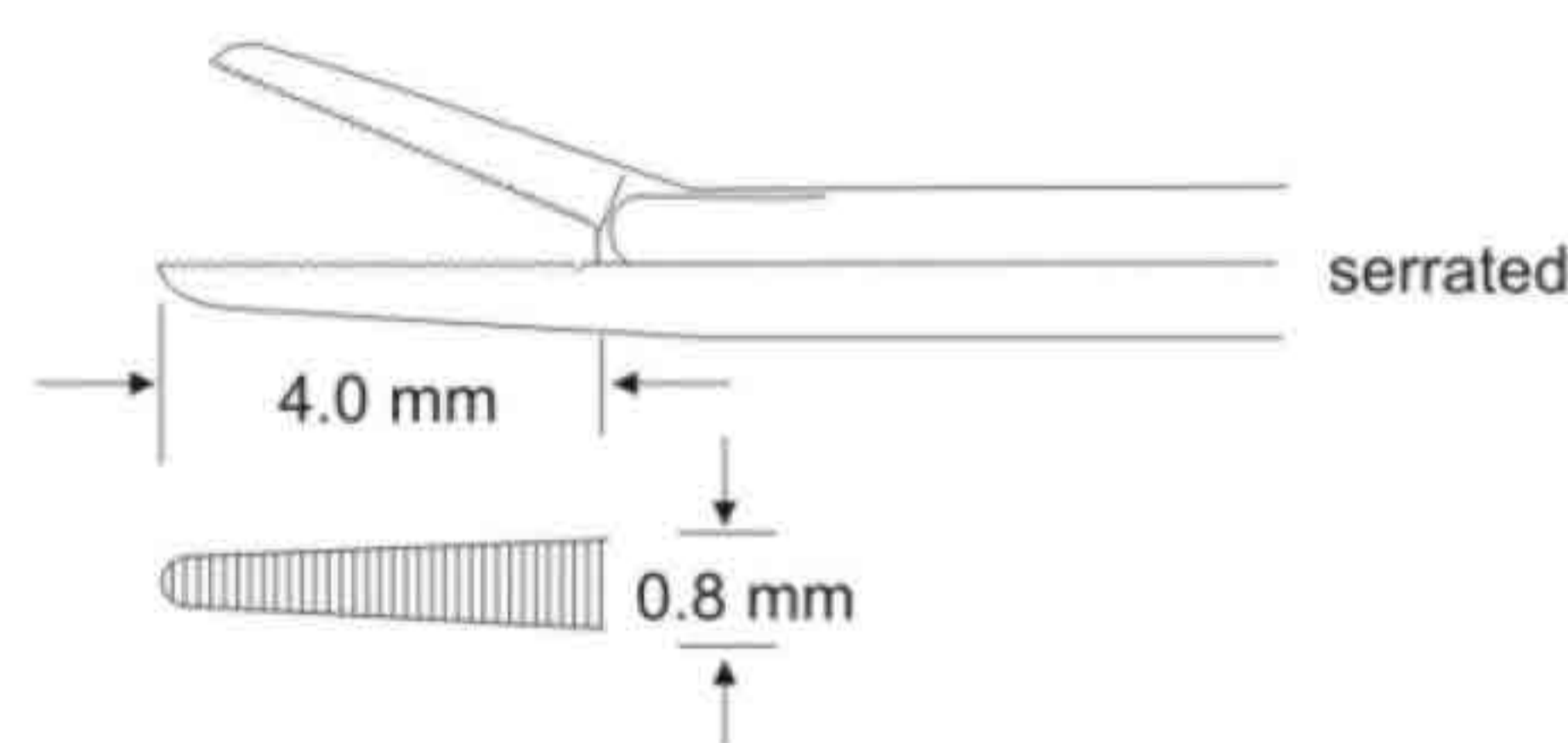
0.8 mm



SSC-43-11-11
straight



SSC-43-11-12
straight



serrated

4.0 mm

0.8 mm



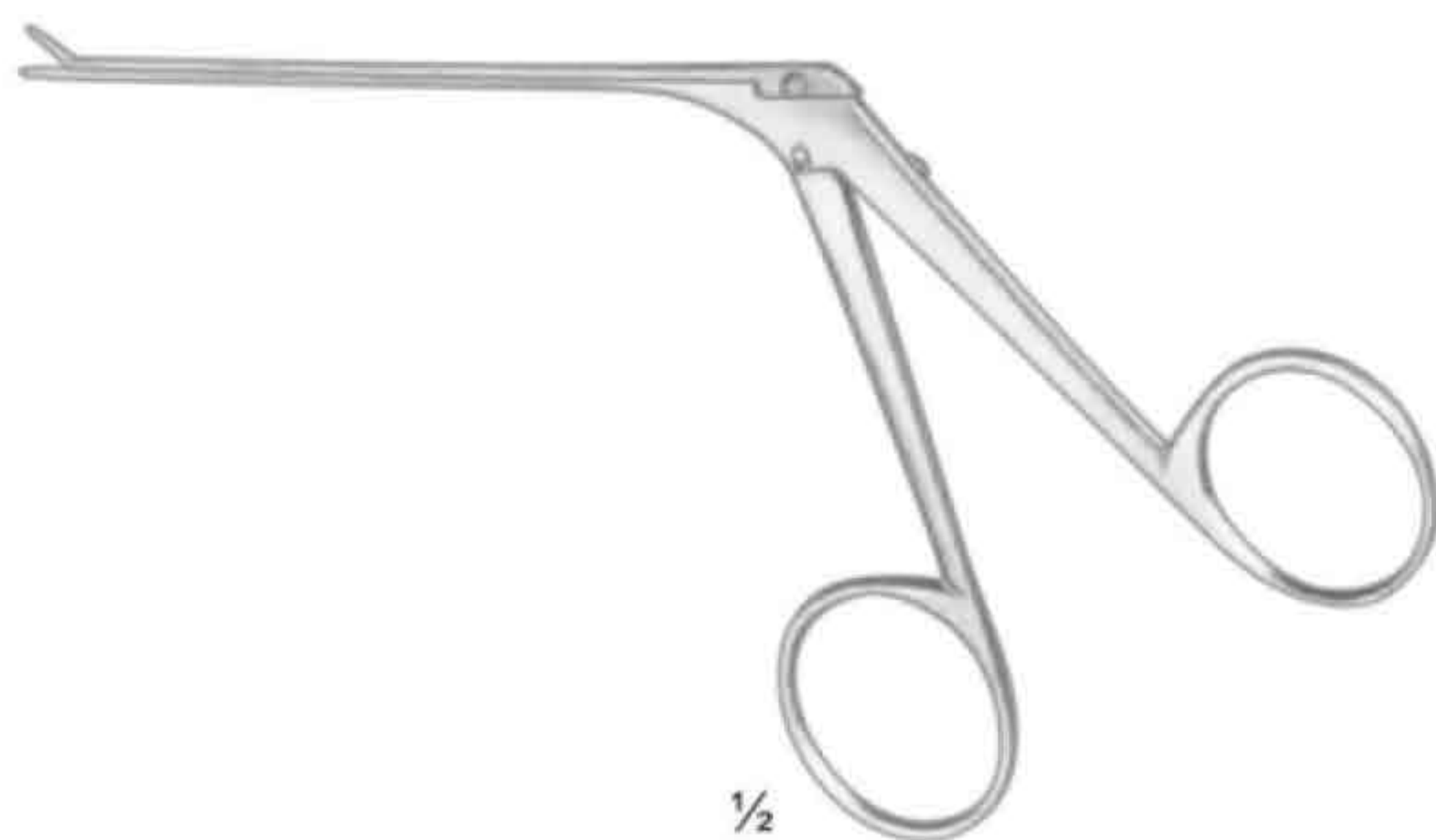
SSC-43-11-12
curved up



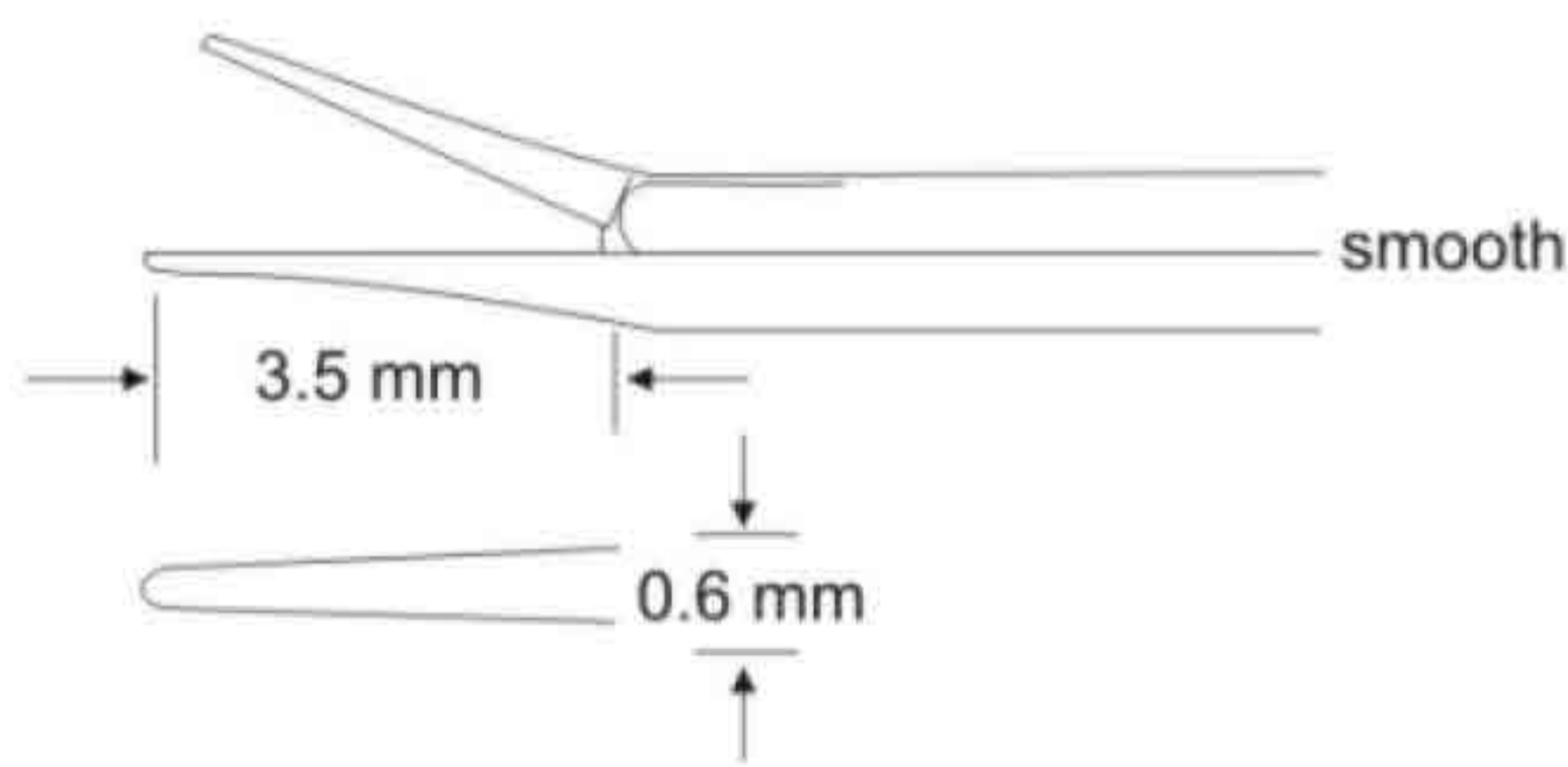
SSC-43-11-14
right



SSC-43-11-15
left



1/2



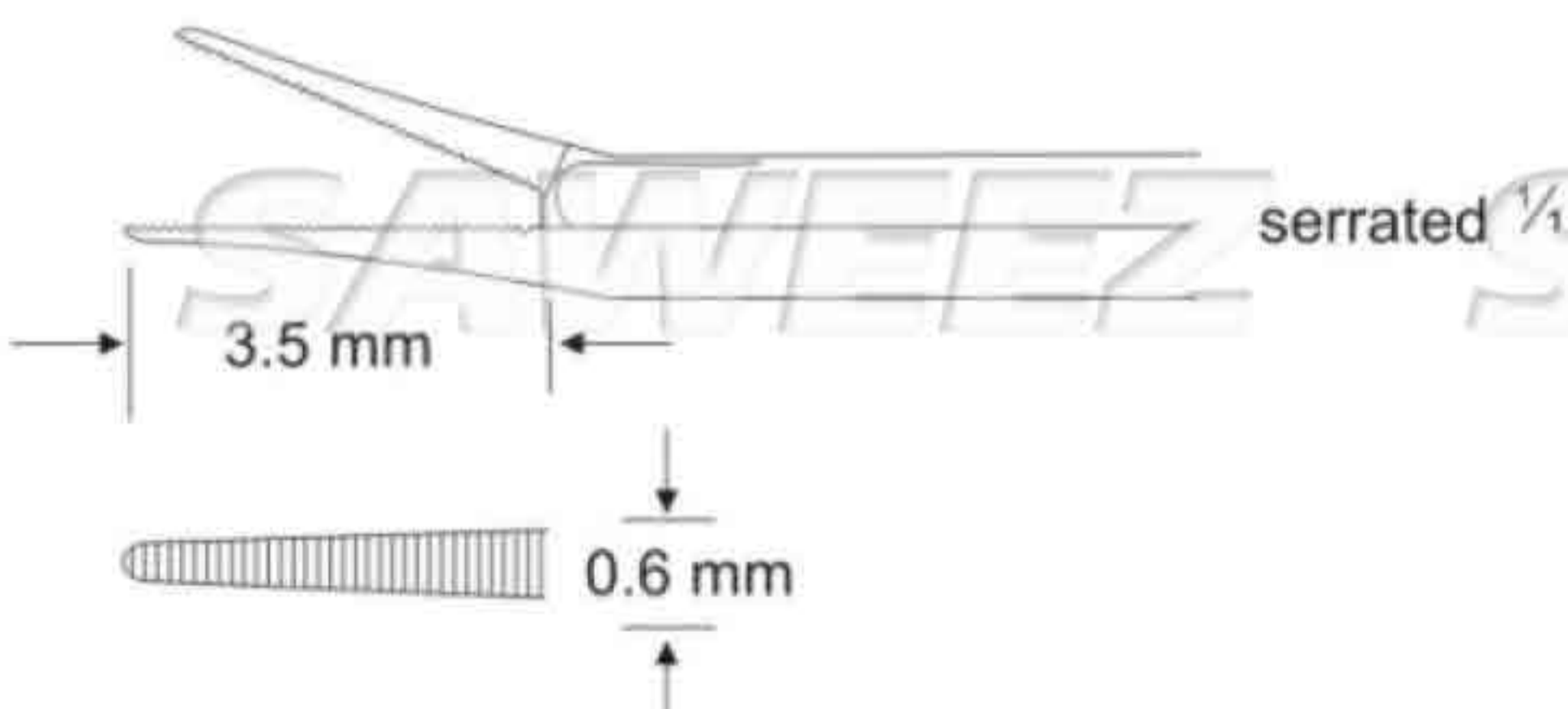
smooth

3.5 mm

0.6 mm



SSC-43-11-16
straight



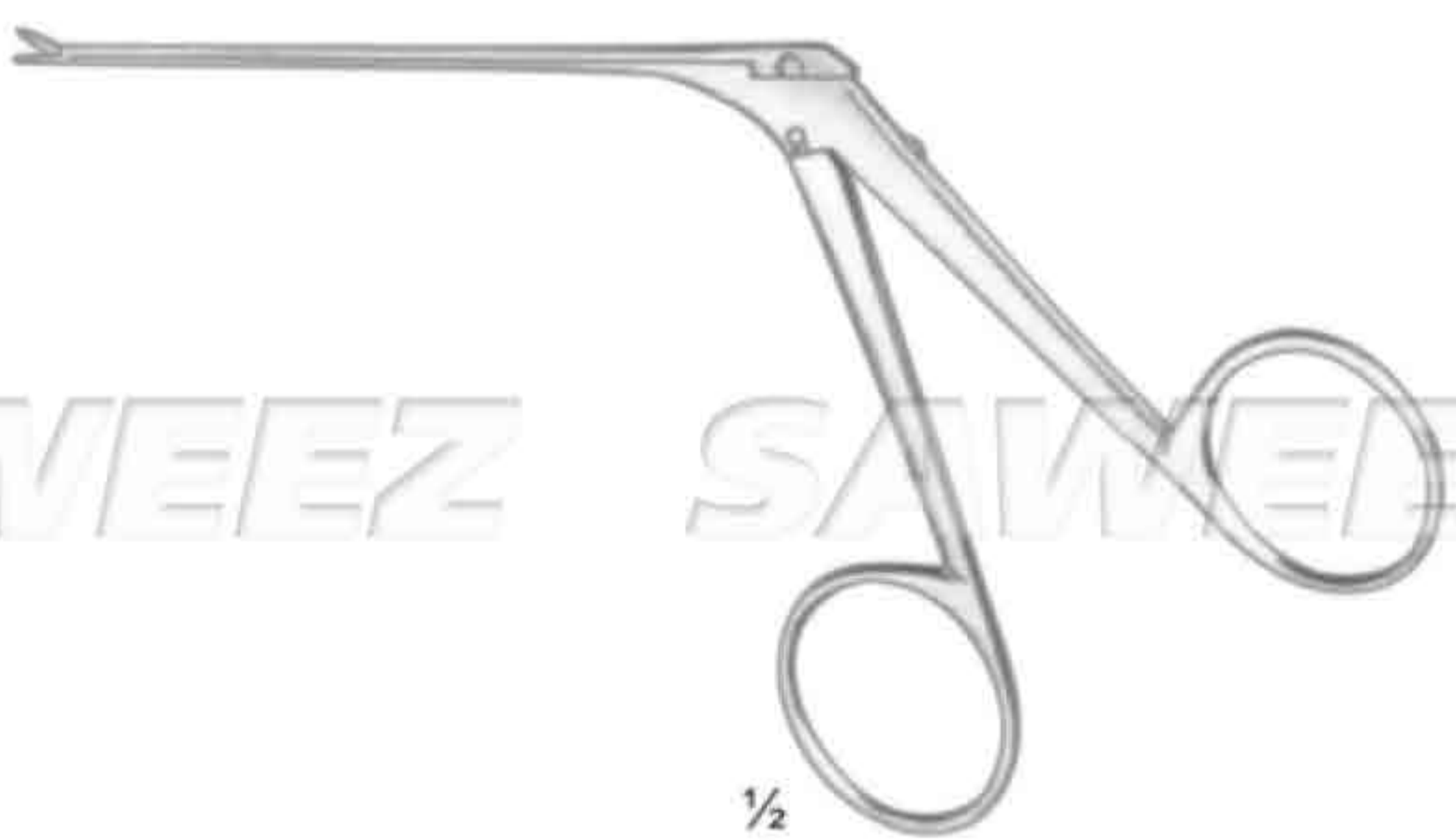
serrated

3.5 mm

0.6 mm



SSC-43-11-17
straight



1/2

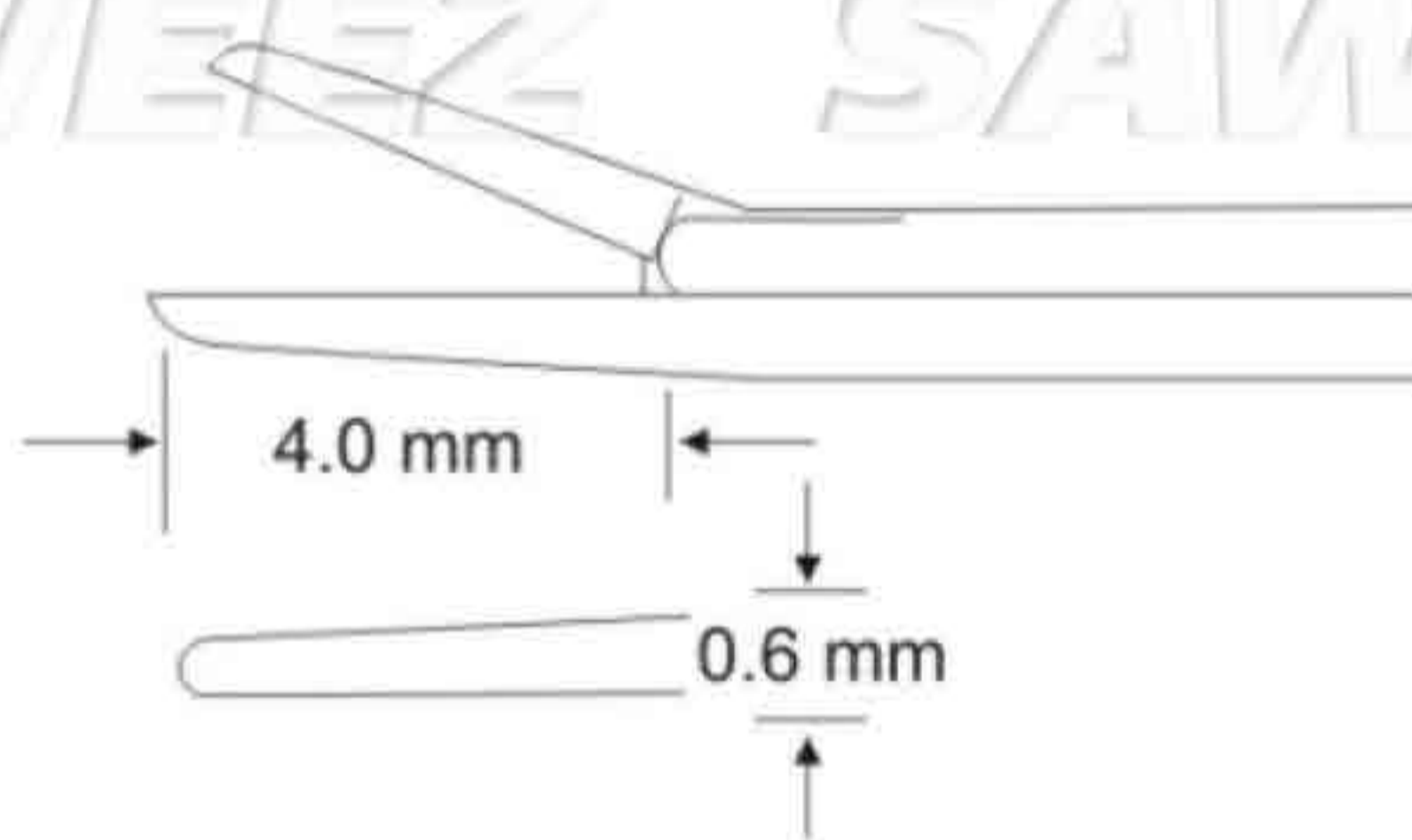
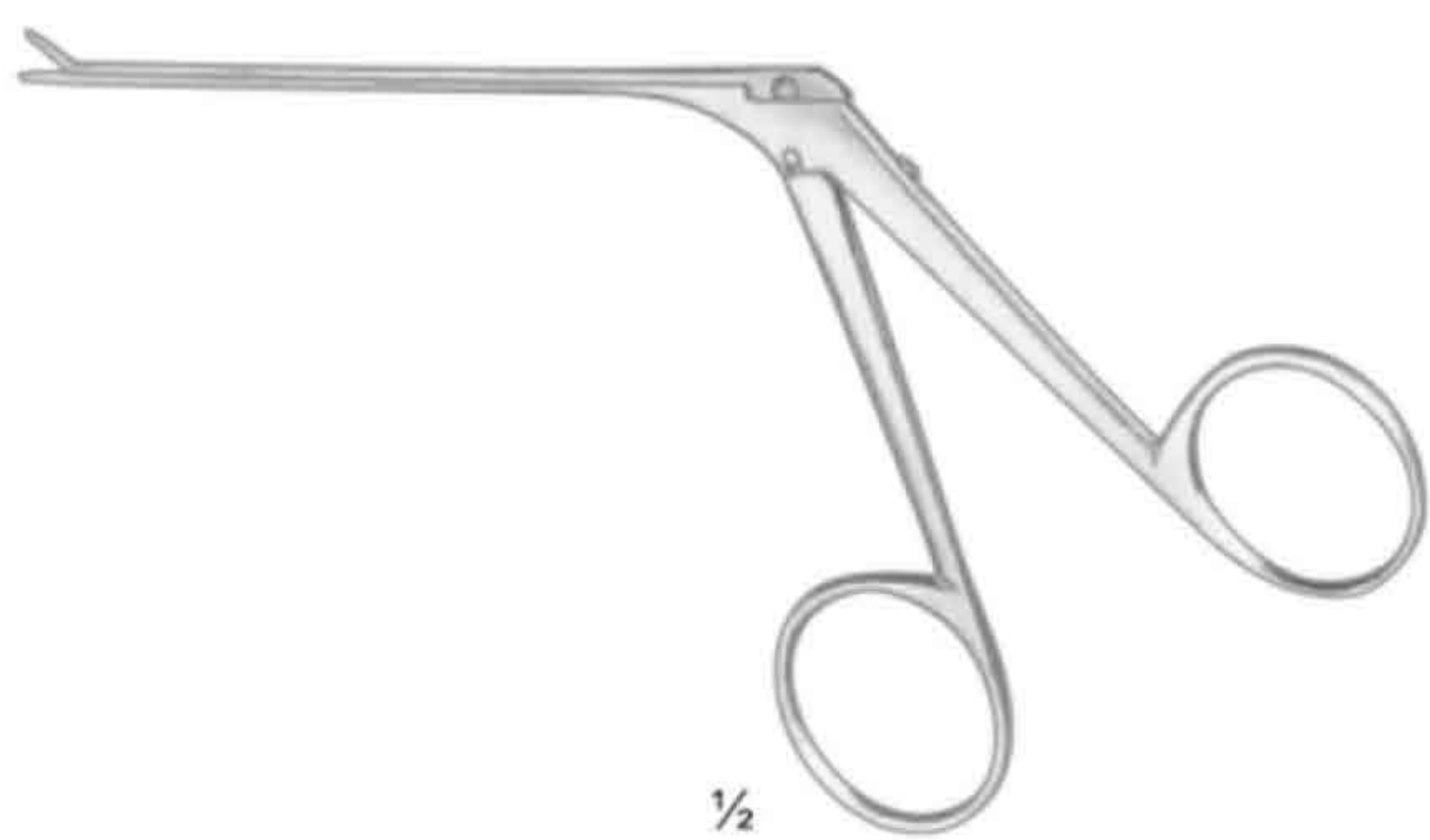
Mini Mcgee Alligator

72 20.0 cm / 8

72 20.0 cm / 8



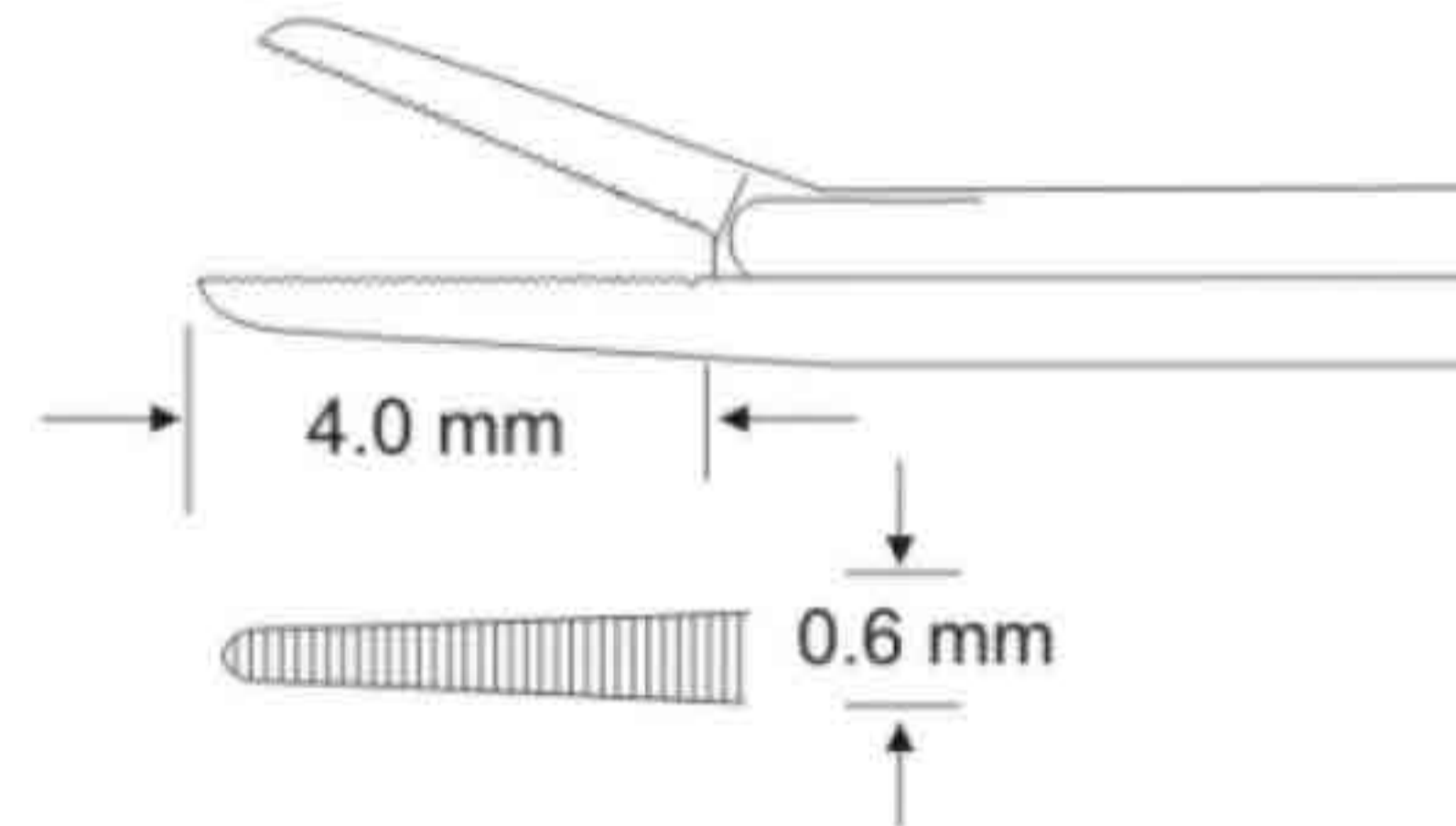
SAWEEZ SAWEEZ SAWEEZ SAWEEZ



smooth 1/4

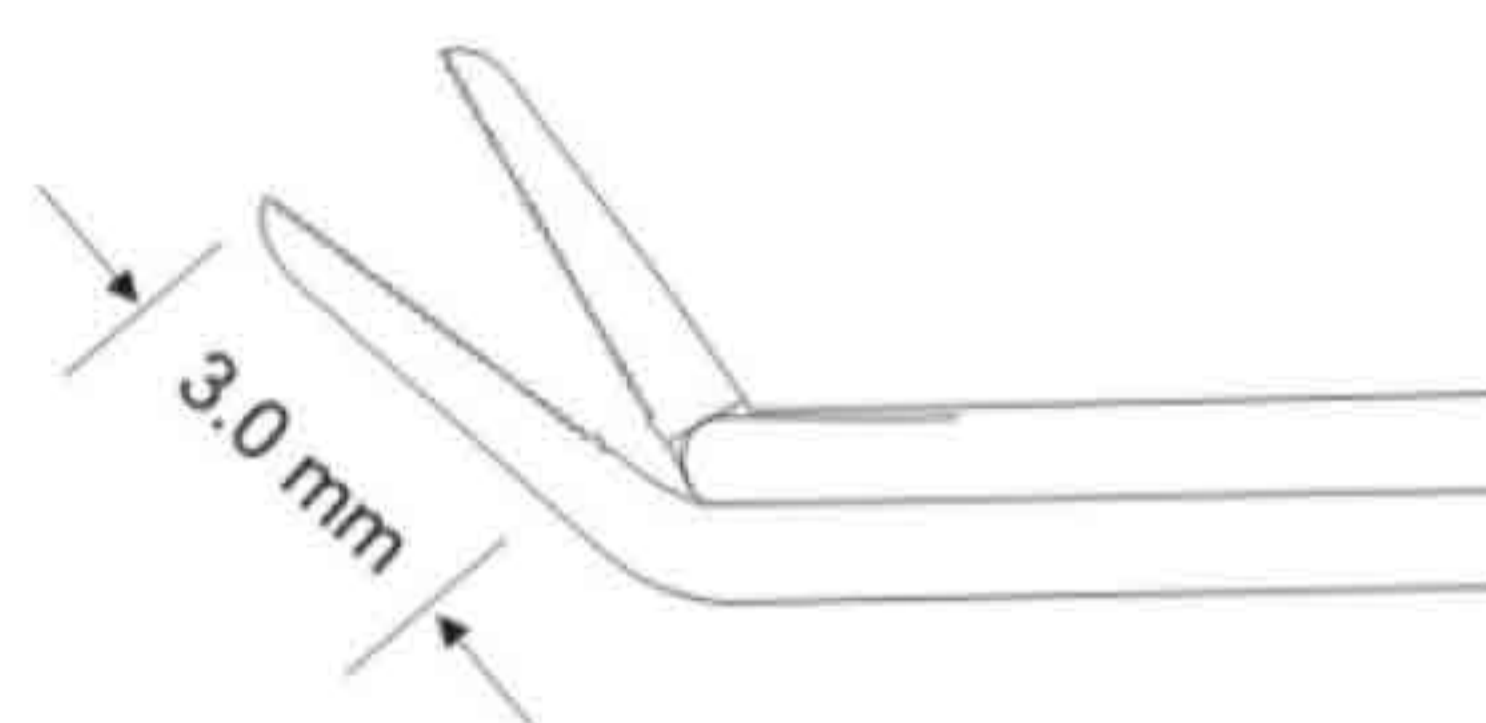
SSC-43-11-18
4.0 x 0.6 mm
straight

SAWEEZ SAWEEZ SAWEEZ SAWEEZ

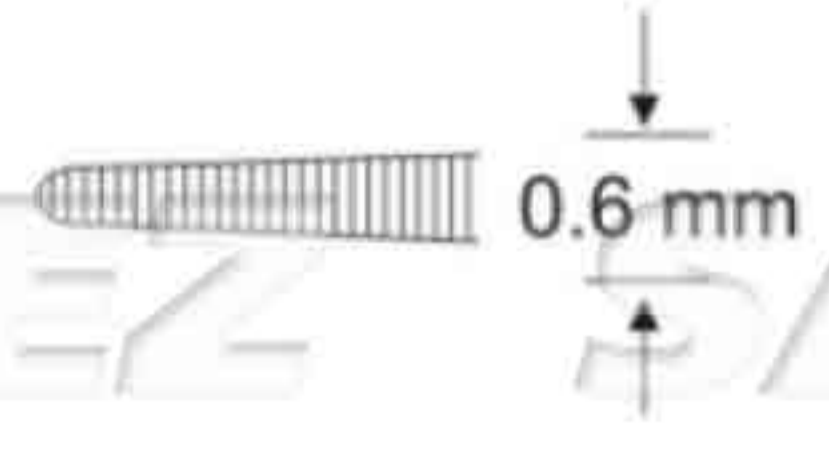
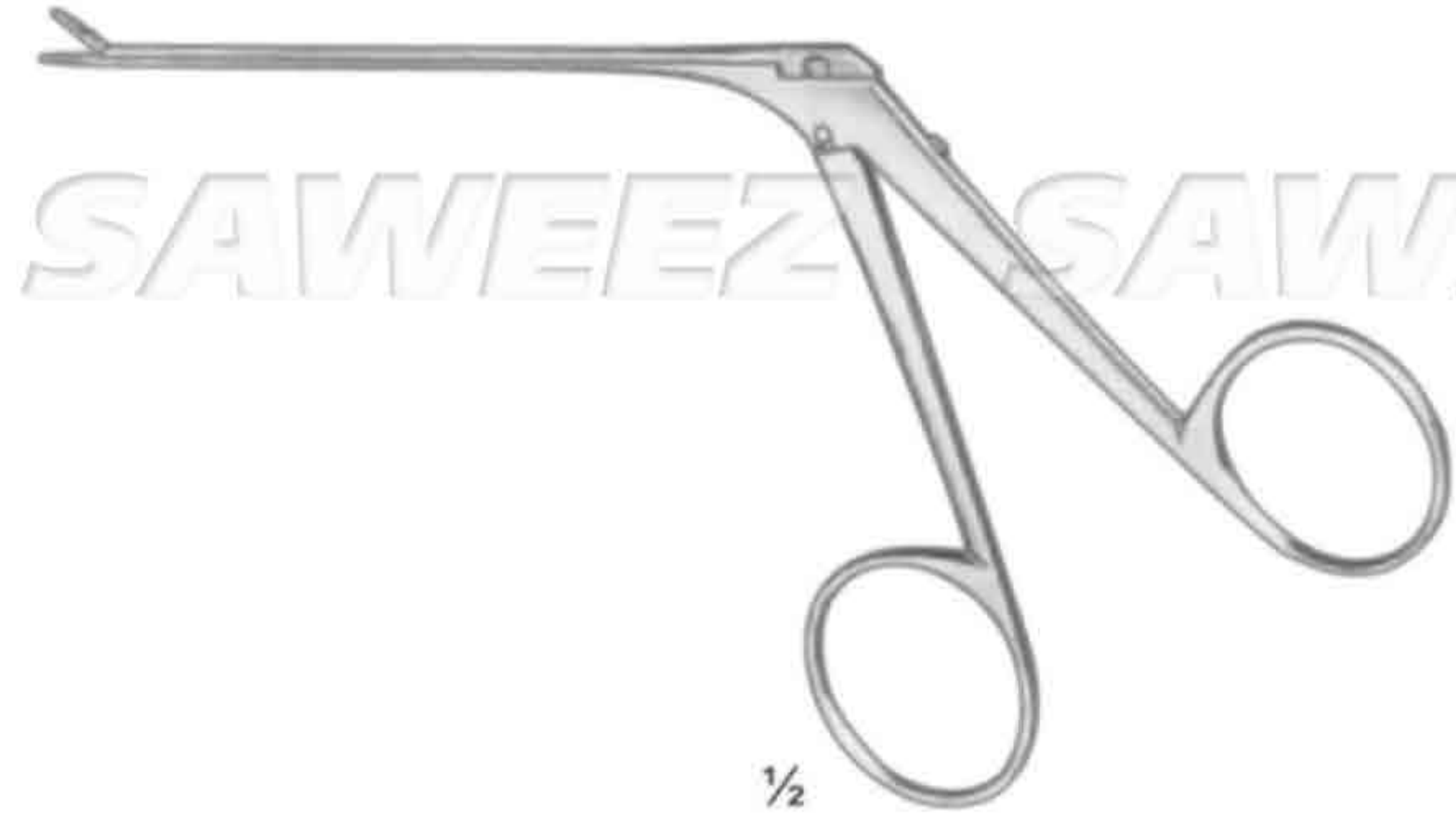


serrated

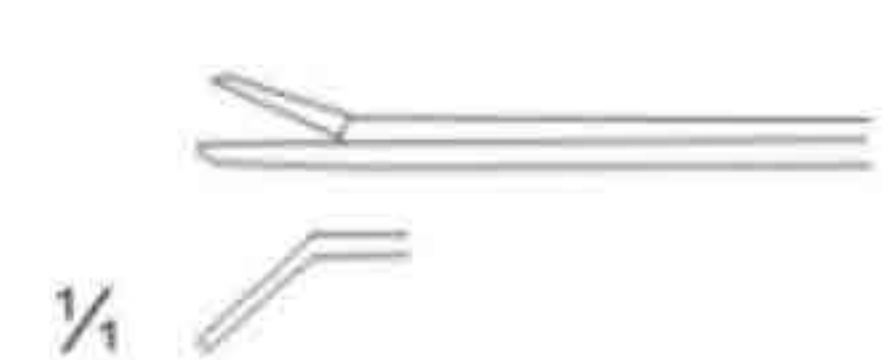
SSC-43-11-19
4.0 x 0.6 mm
straight



SSC-43-11-20
3.0 x 0.6 mm
curved up



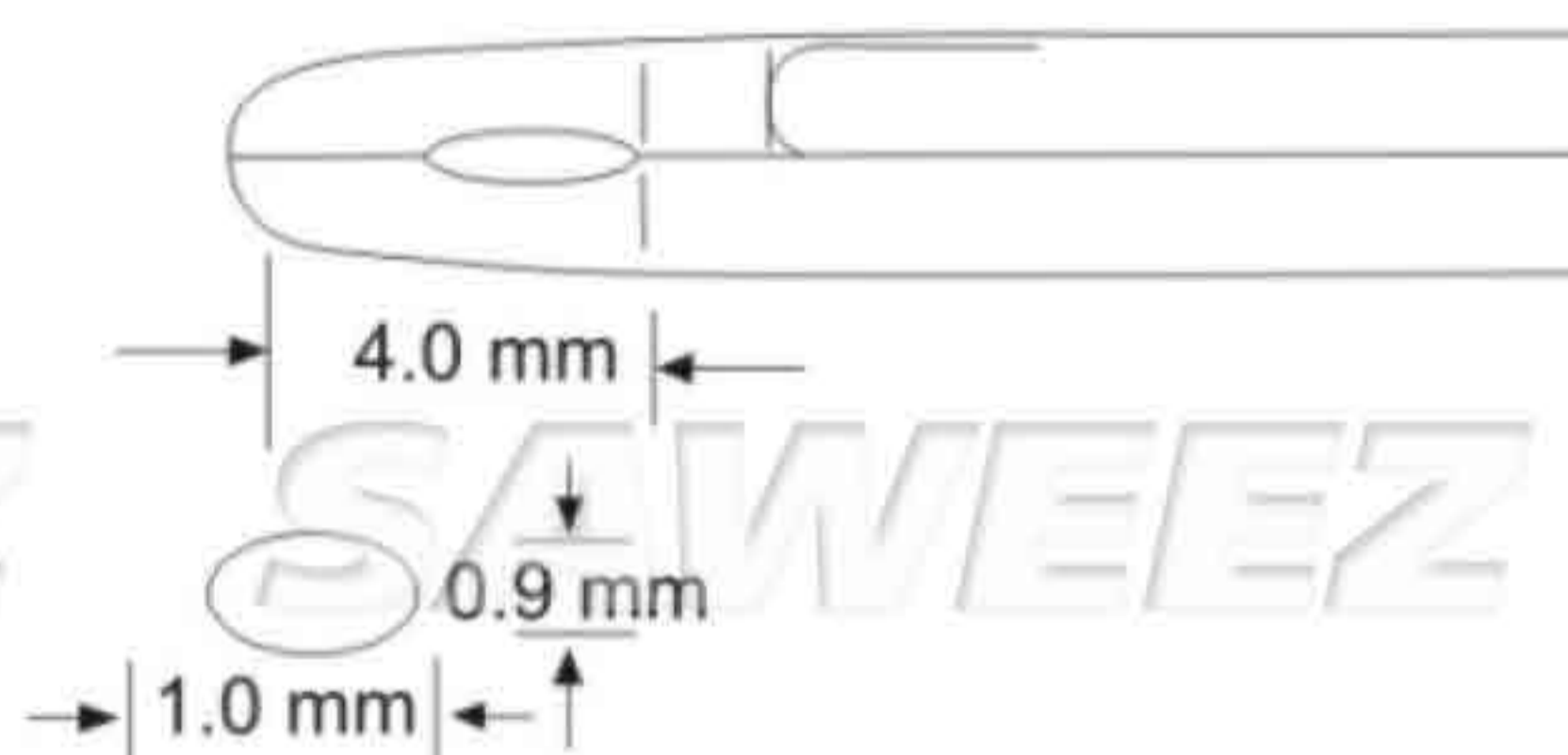
SSC-43-11-21
3.0 x 0.6 mm
right



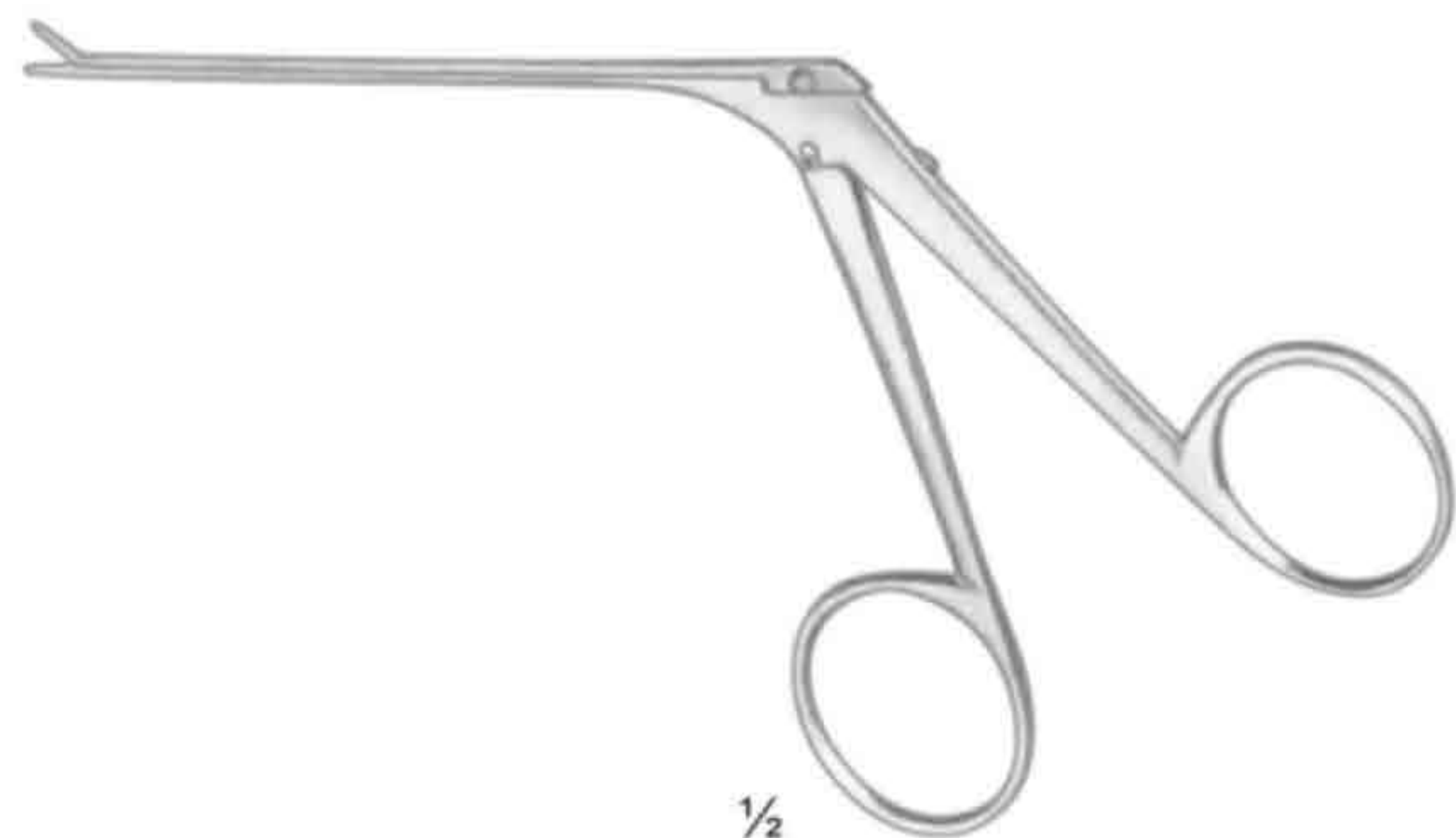
SSC-43-11-22
3.0 x 0.6 mm
left



80 mm



SAWEEZ SAWEEZ SAWEEZ SAWEEZ



1/2



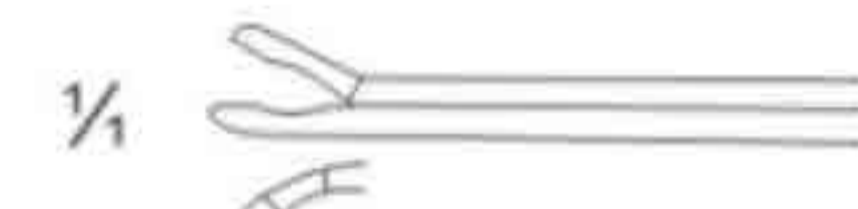
SSC-43-11-23
straight



SSC-43-11-24
curved up

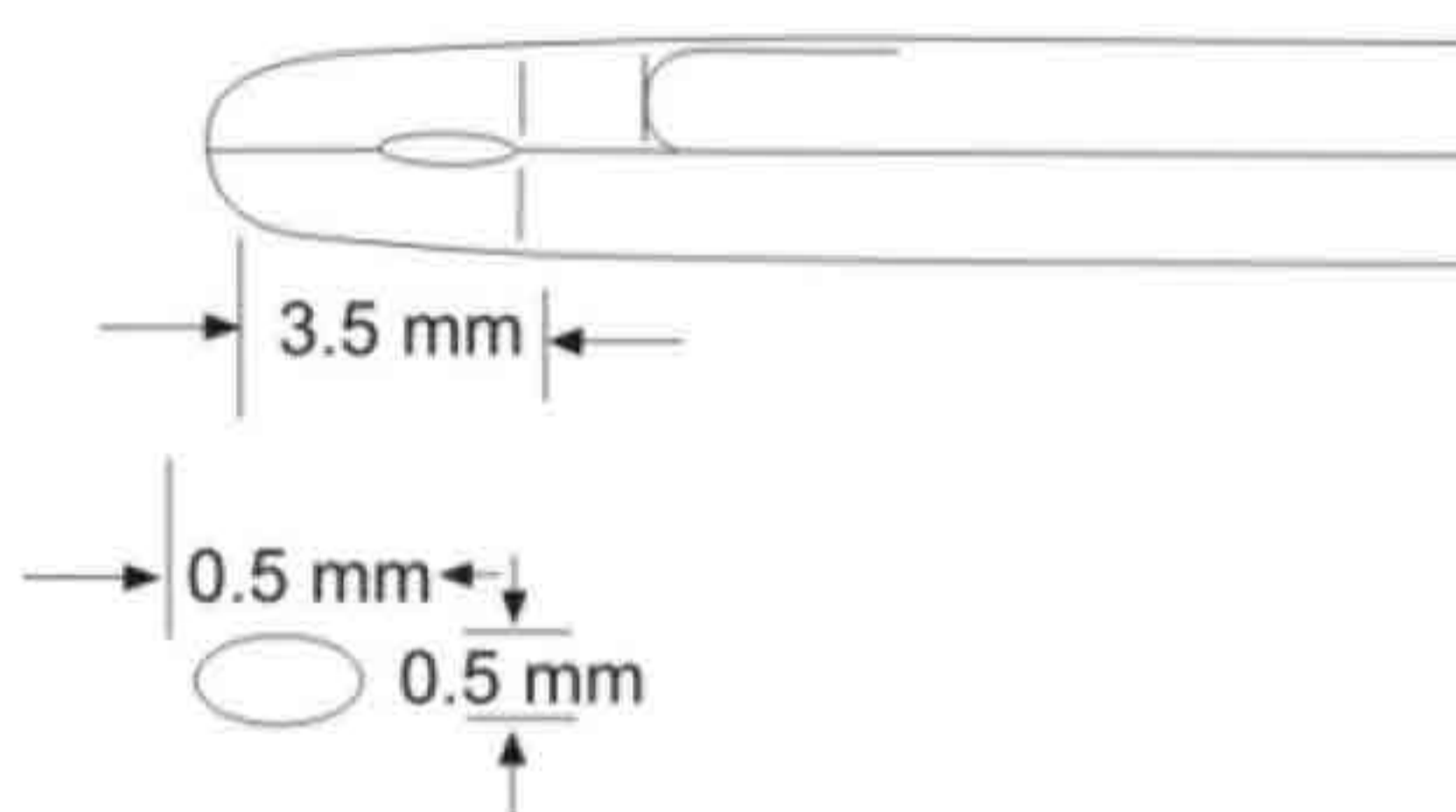


SSC-43-11-25
right



SSC-43-11-26
left

SAWEEZ SAWEEZ SAWEEZ SAWEEZ



SSC-43-11-27
straight



SSC-43-11-28
curved up

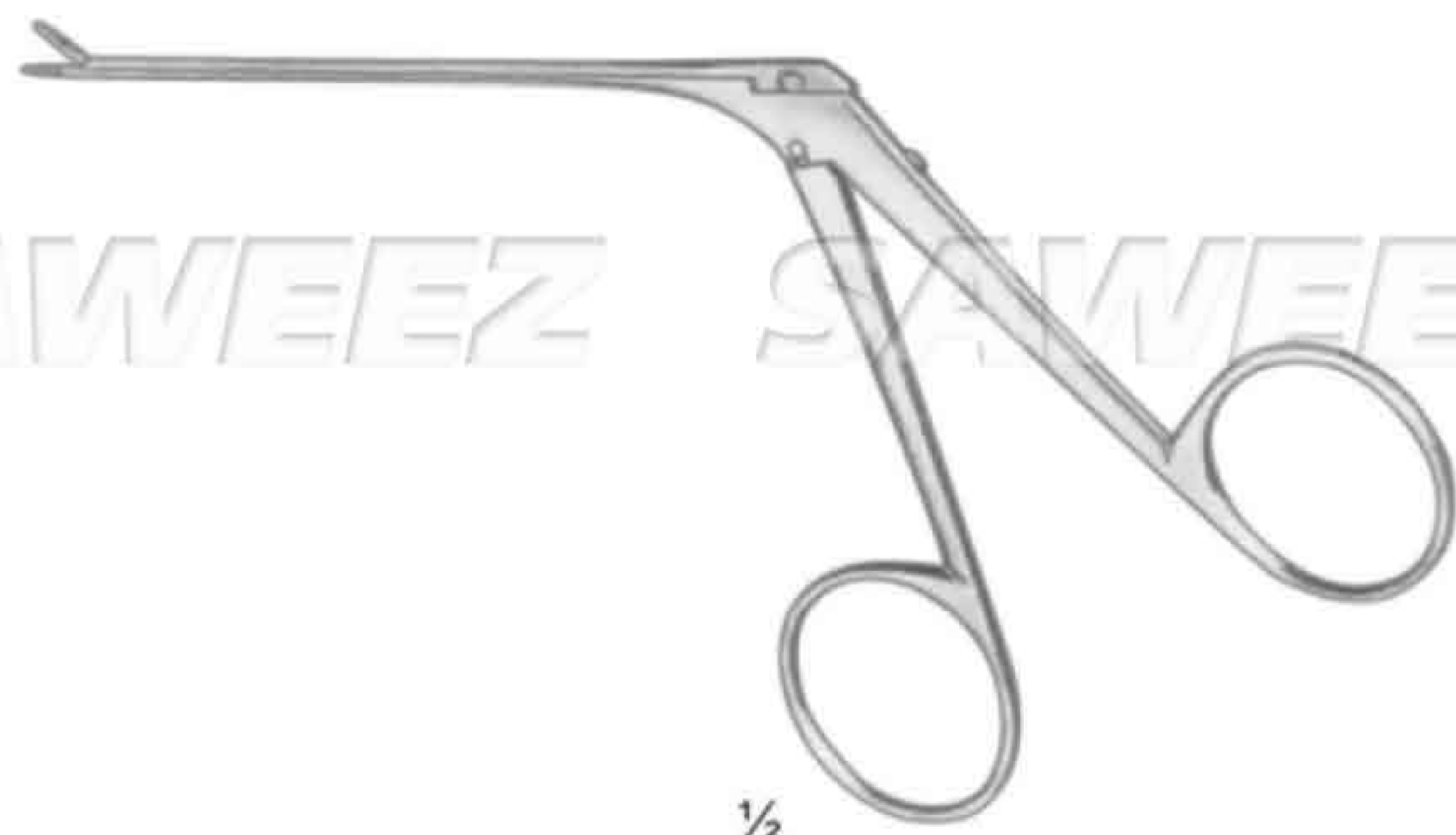


SSC-43-11-29
right

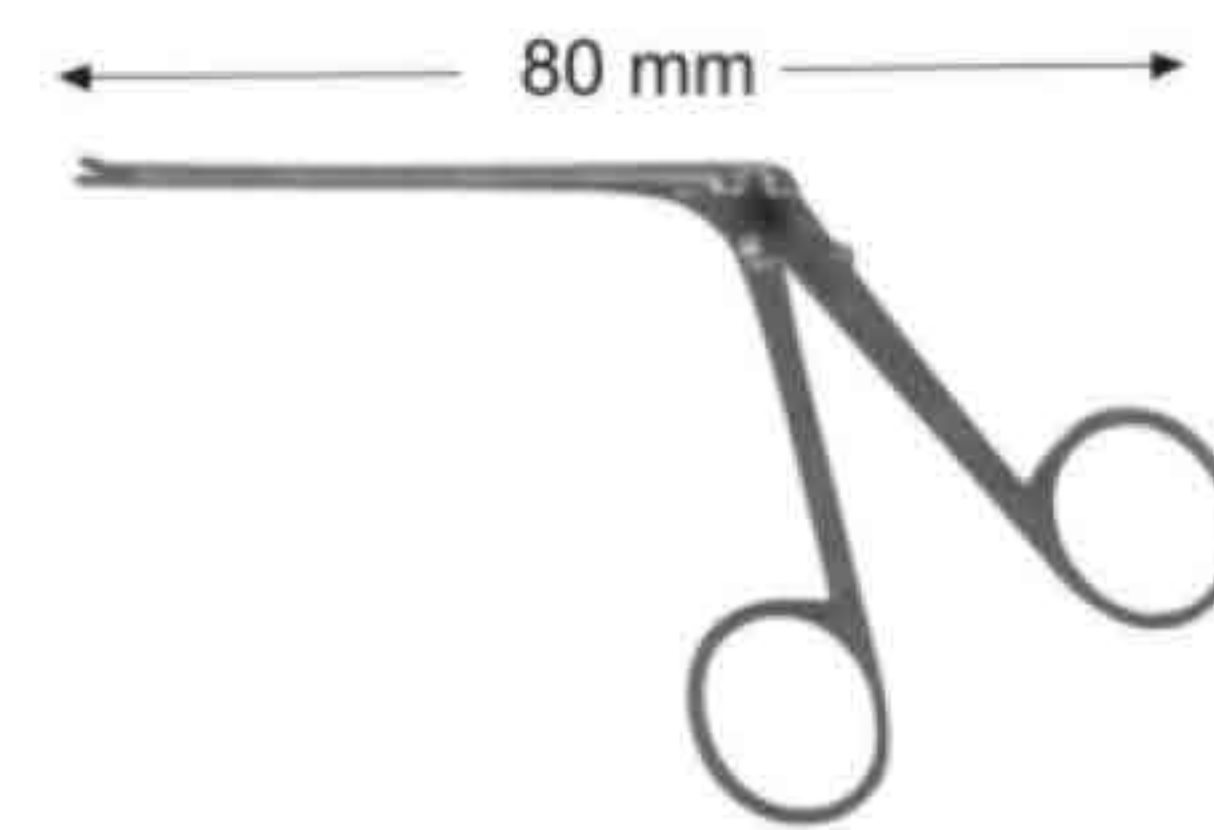


SSC-43-11-30
left

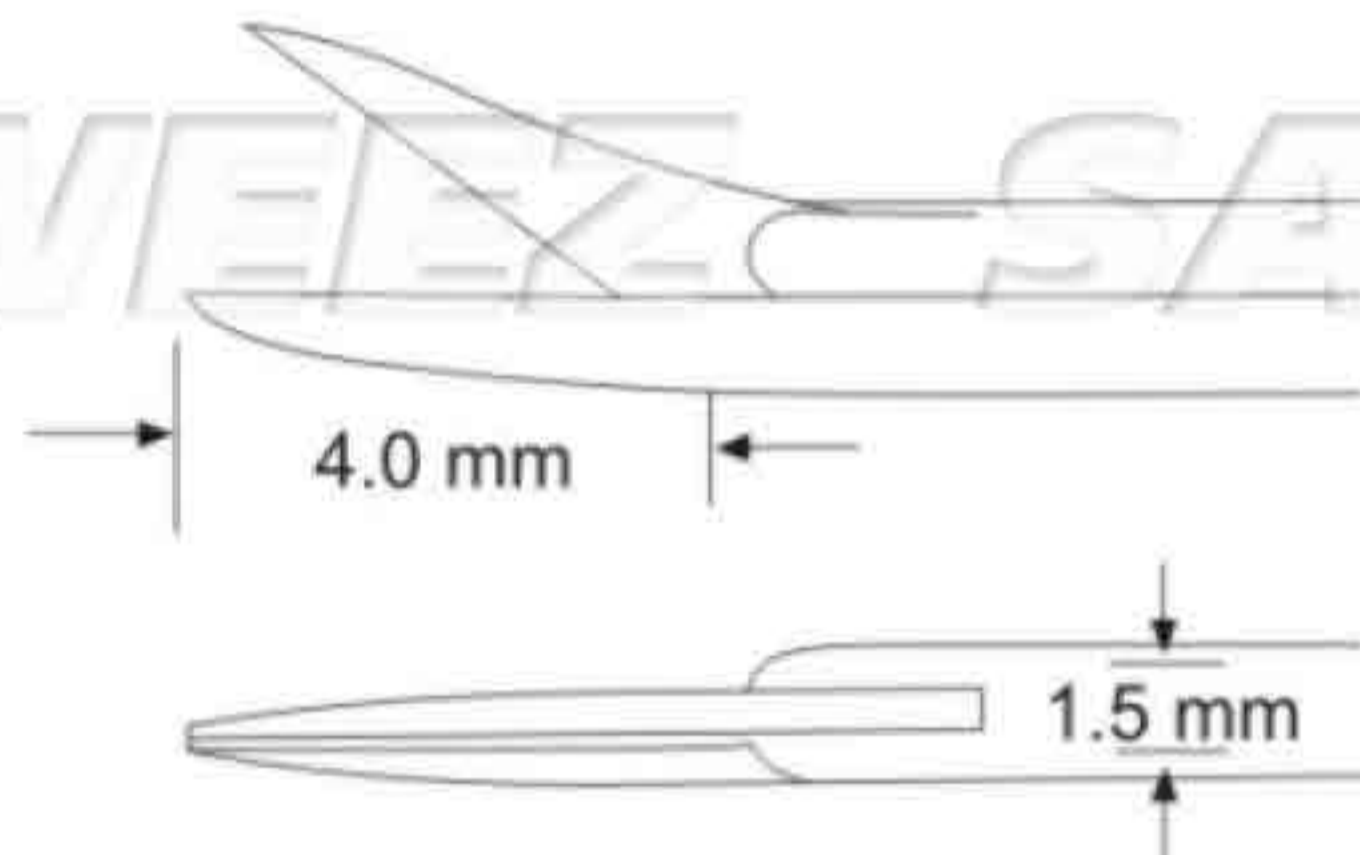
SAWEEZ SAWEEZ SAWEEZ SAWEEZ



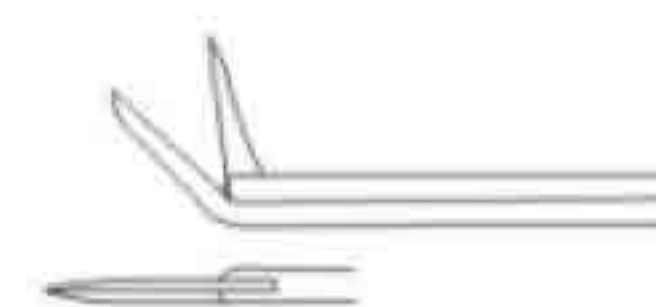
1/2



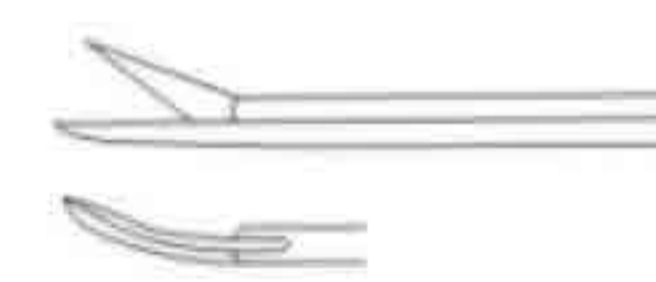
SAWEEZ SAWEEZ SAWEEZ SAWEEZ



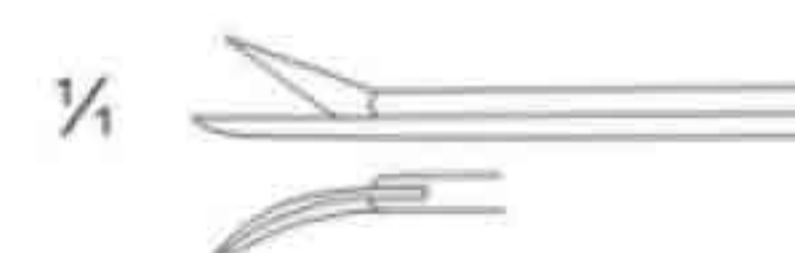
SSC-43-11-31
straight



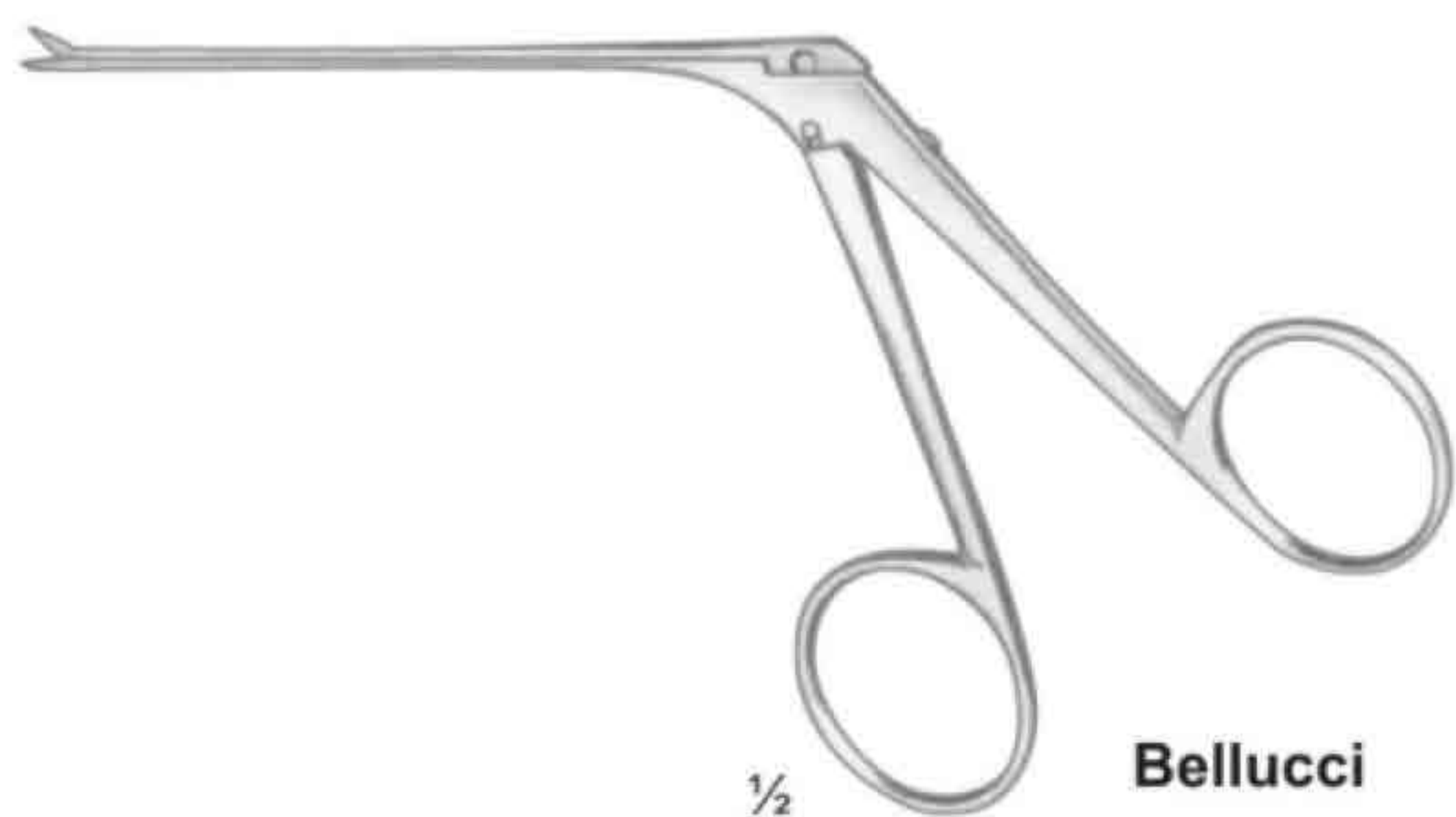
SSC-43-11-32
curved up



SSC-43-11-33
right

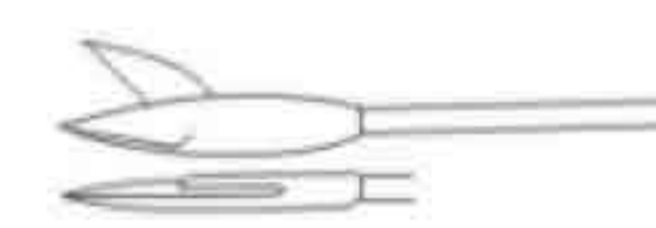
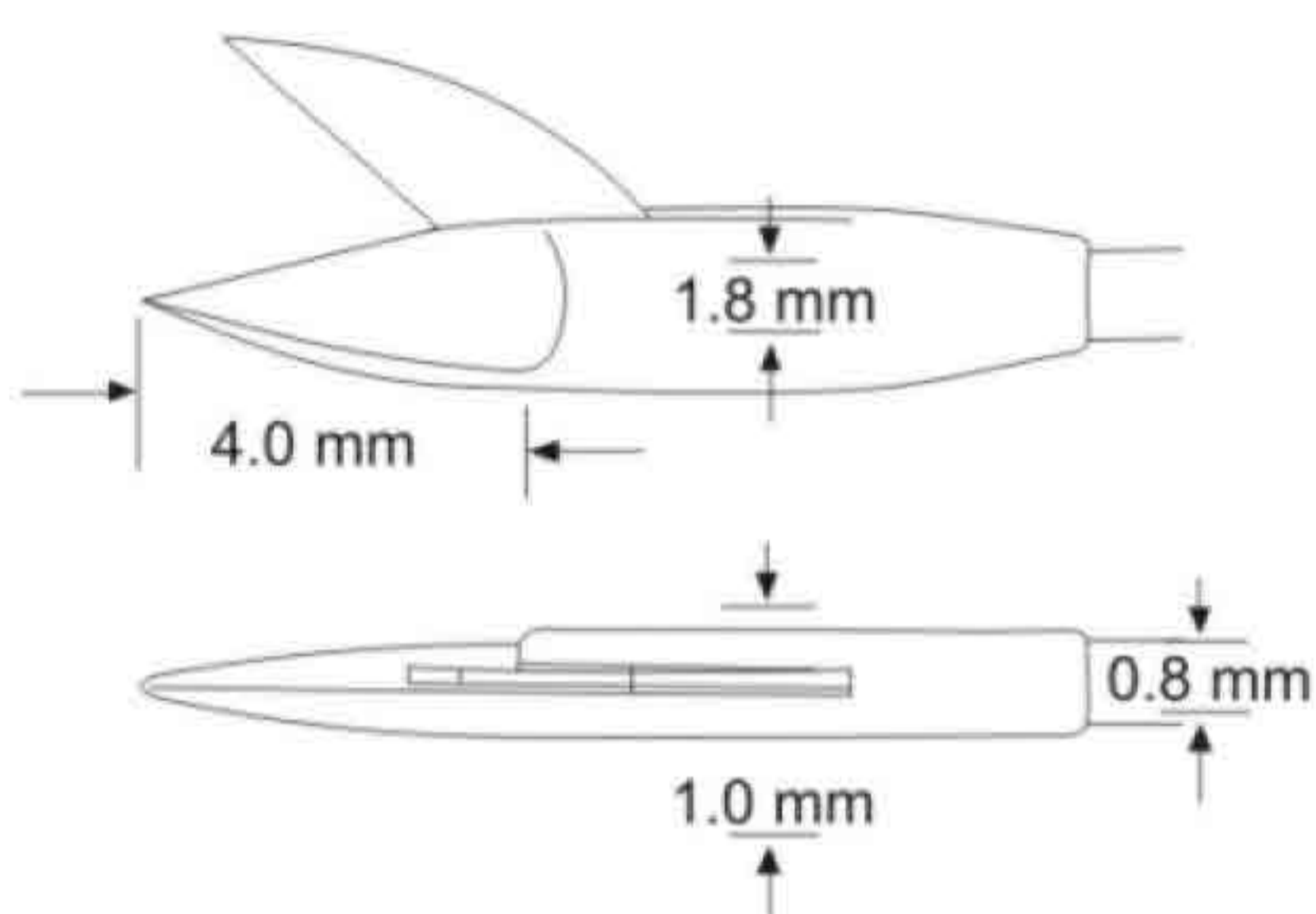


SSC-43-11-34
left



1/2 **Bellucci**

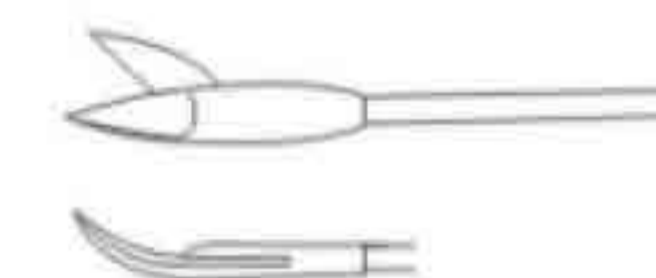
SAWEEZ SAWEEZ SAWEEZ SAWEEZ



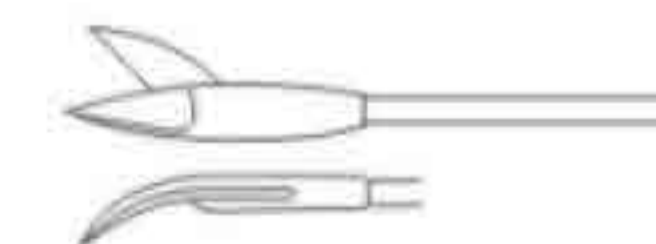
SSC-43-11-35
straight



SSC-43-11-36
curved up



SSC-43-11-37
right

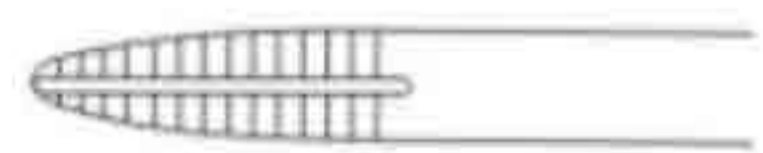
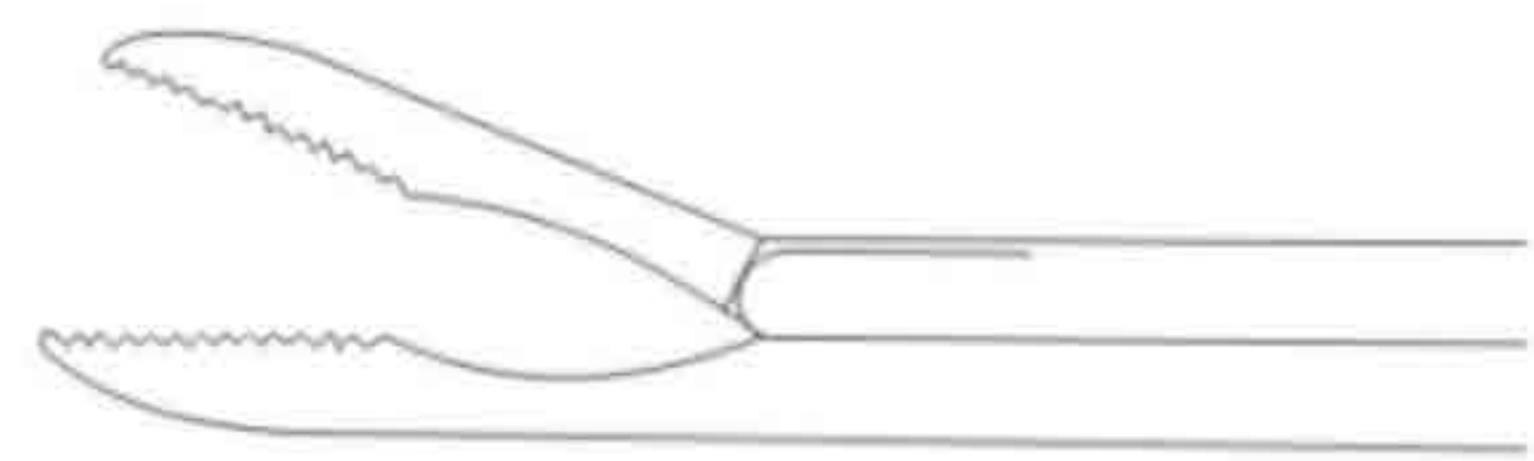


SSC-43-11-38
left



1/2 **Wullstein**

SAWEEZ SAWEEZ SAWEEZ SAWEEZ

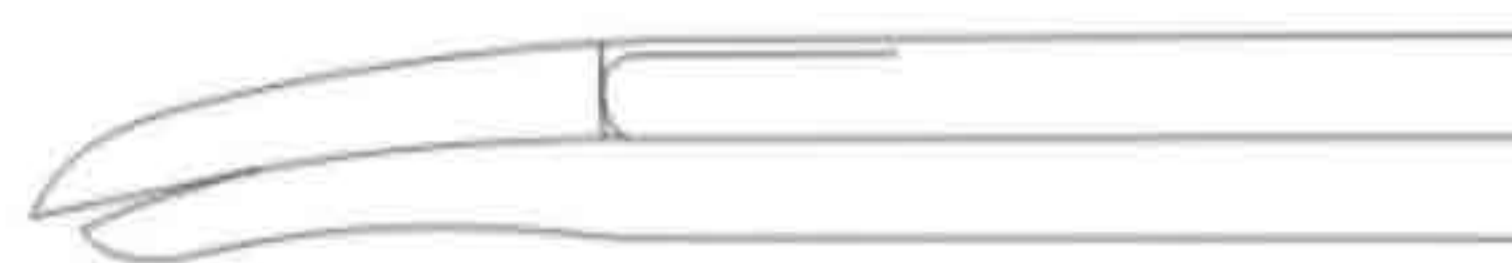


SAWEEZ SAWEEZ

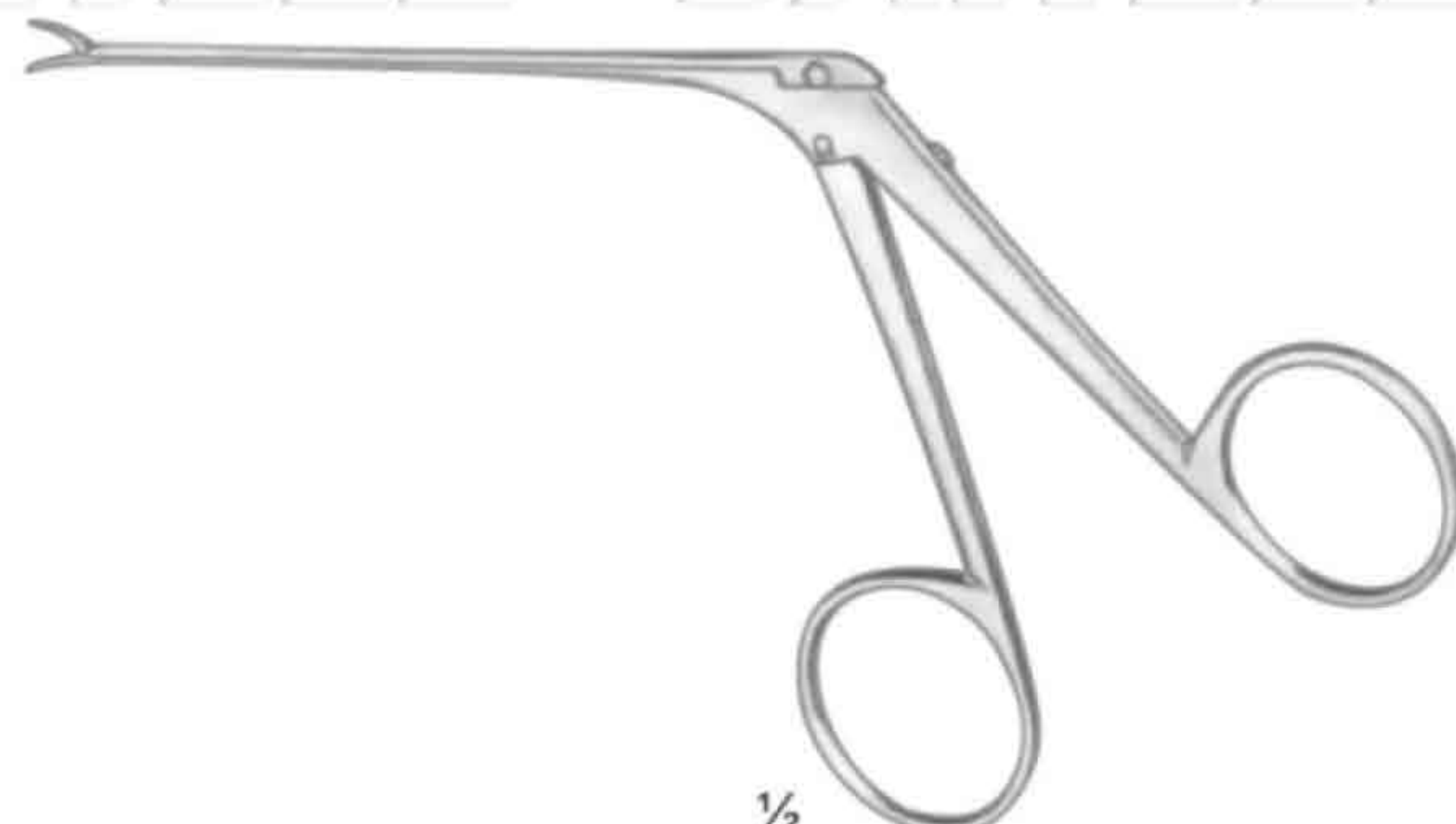


1/2

Greven
SSC-43-11-39



SAWEEZ SAWEEZ

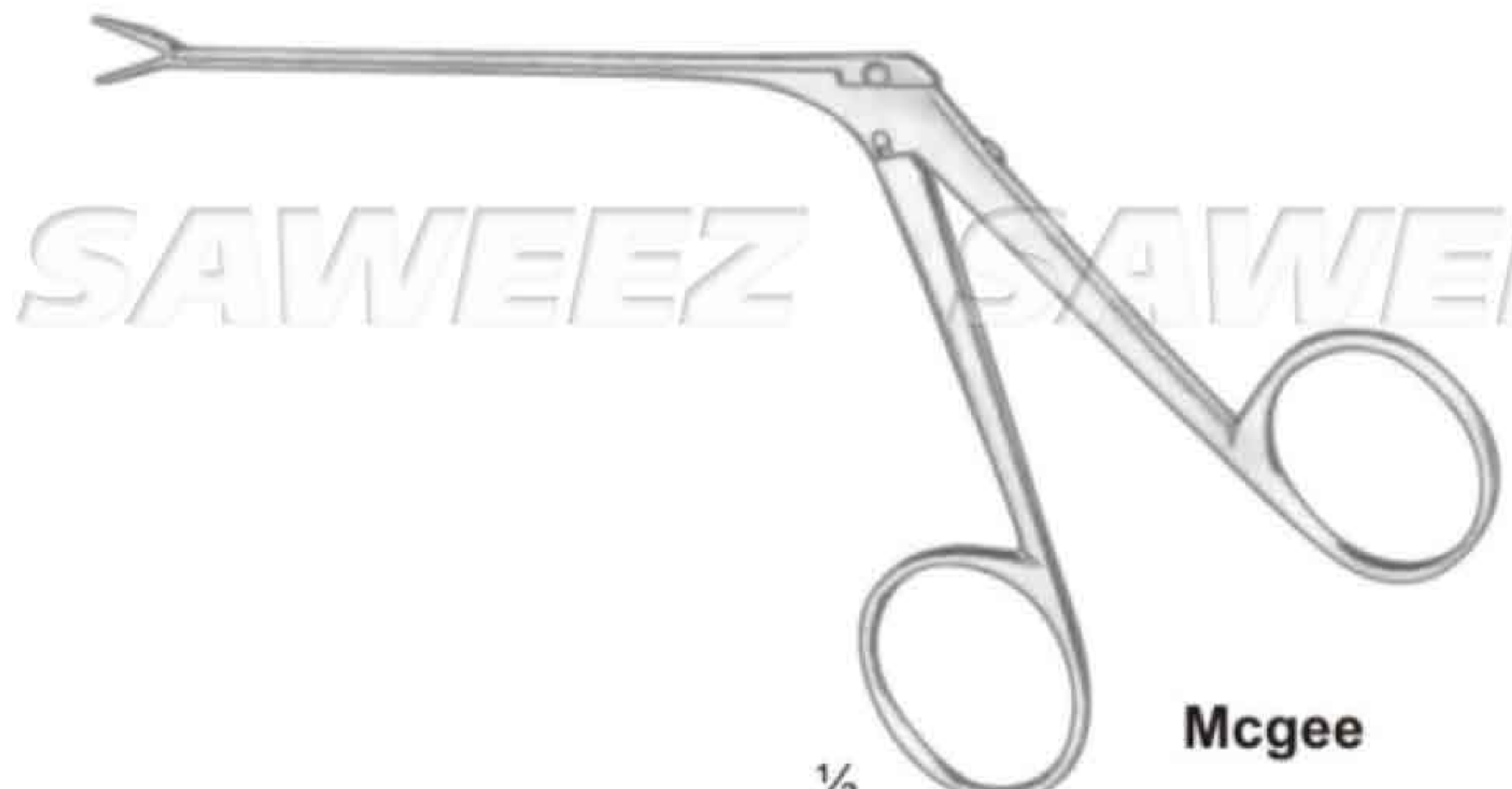
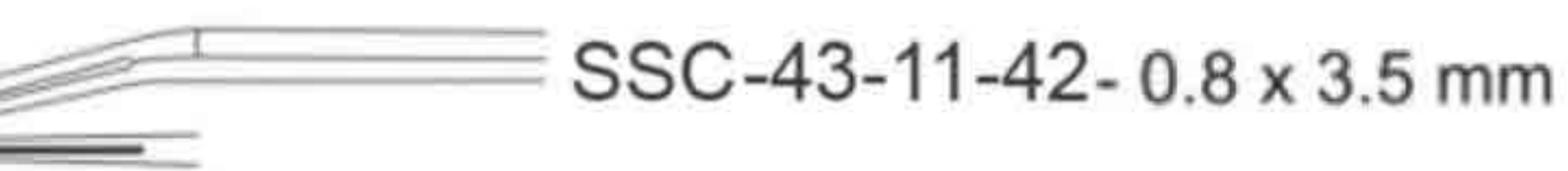
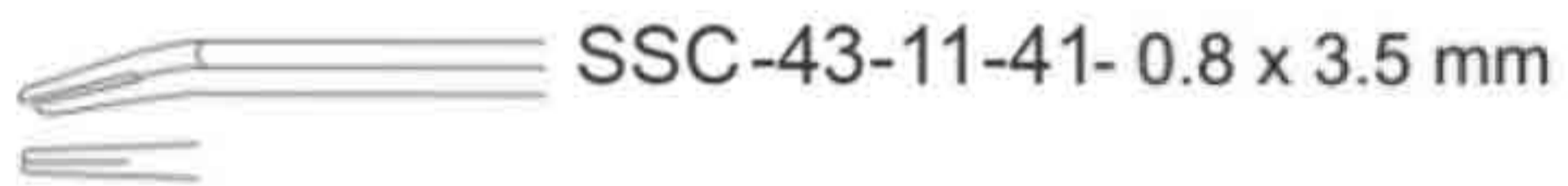
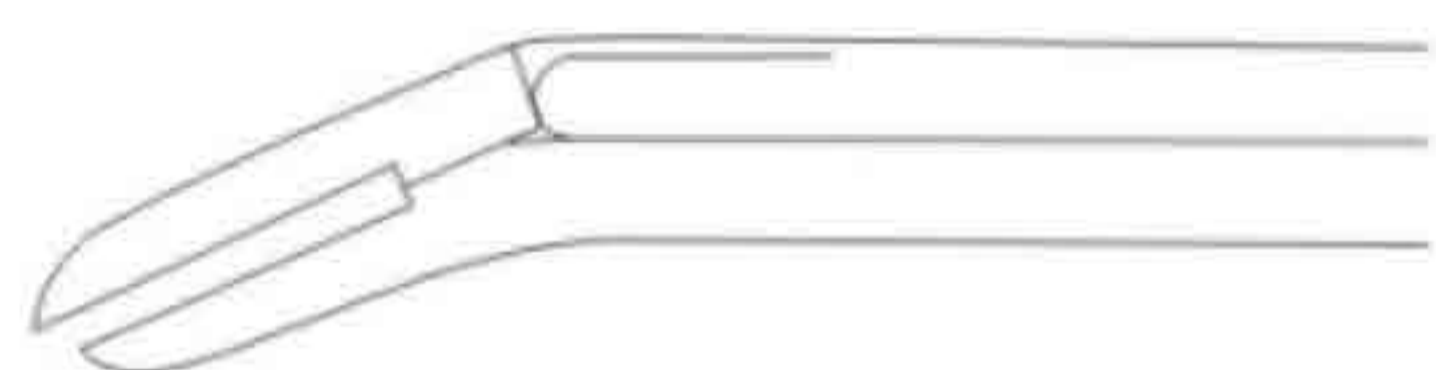


1/2

Schuknecht
SSC-43-11-40

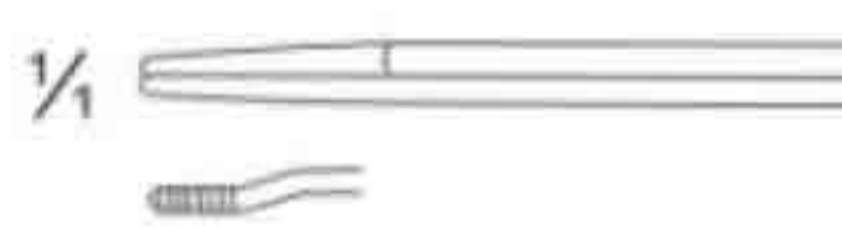
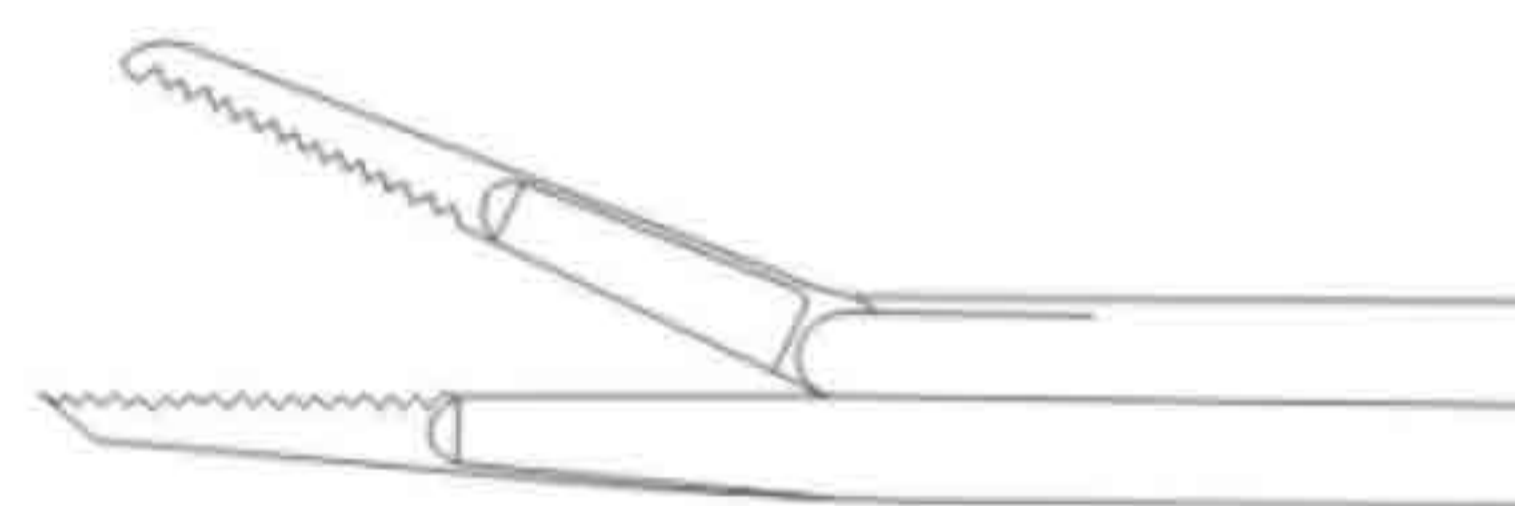
SAWEEZ SAWEEZ

SAWEEZ SAWEEZ

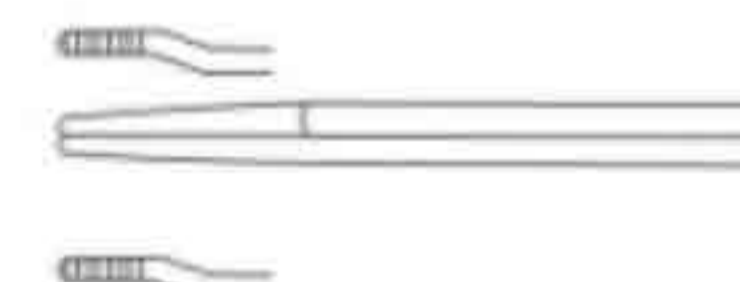


1/2

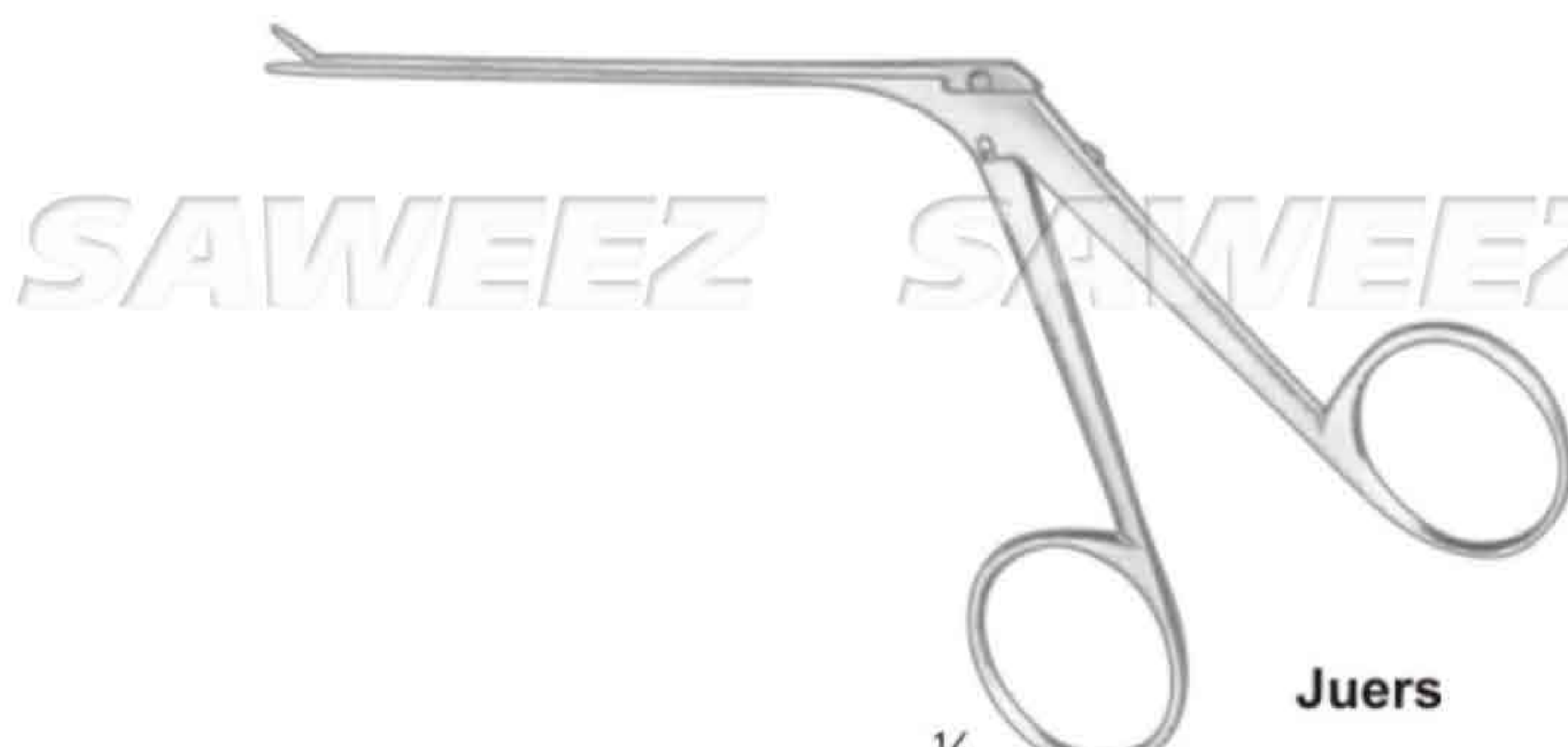
Mcgee



SSC-43-11-43
left

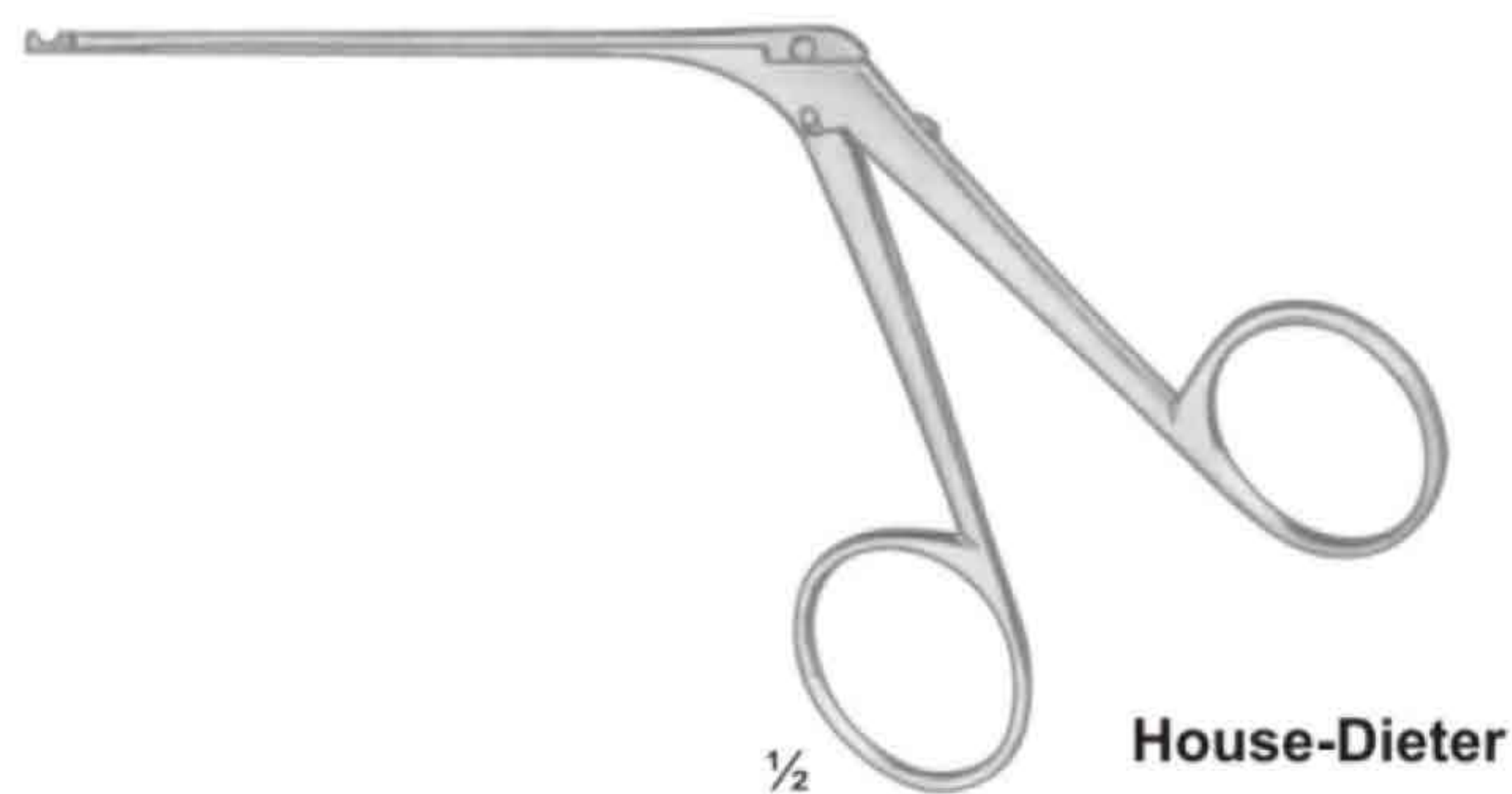
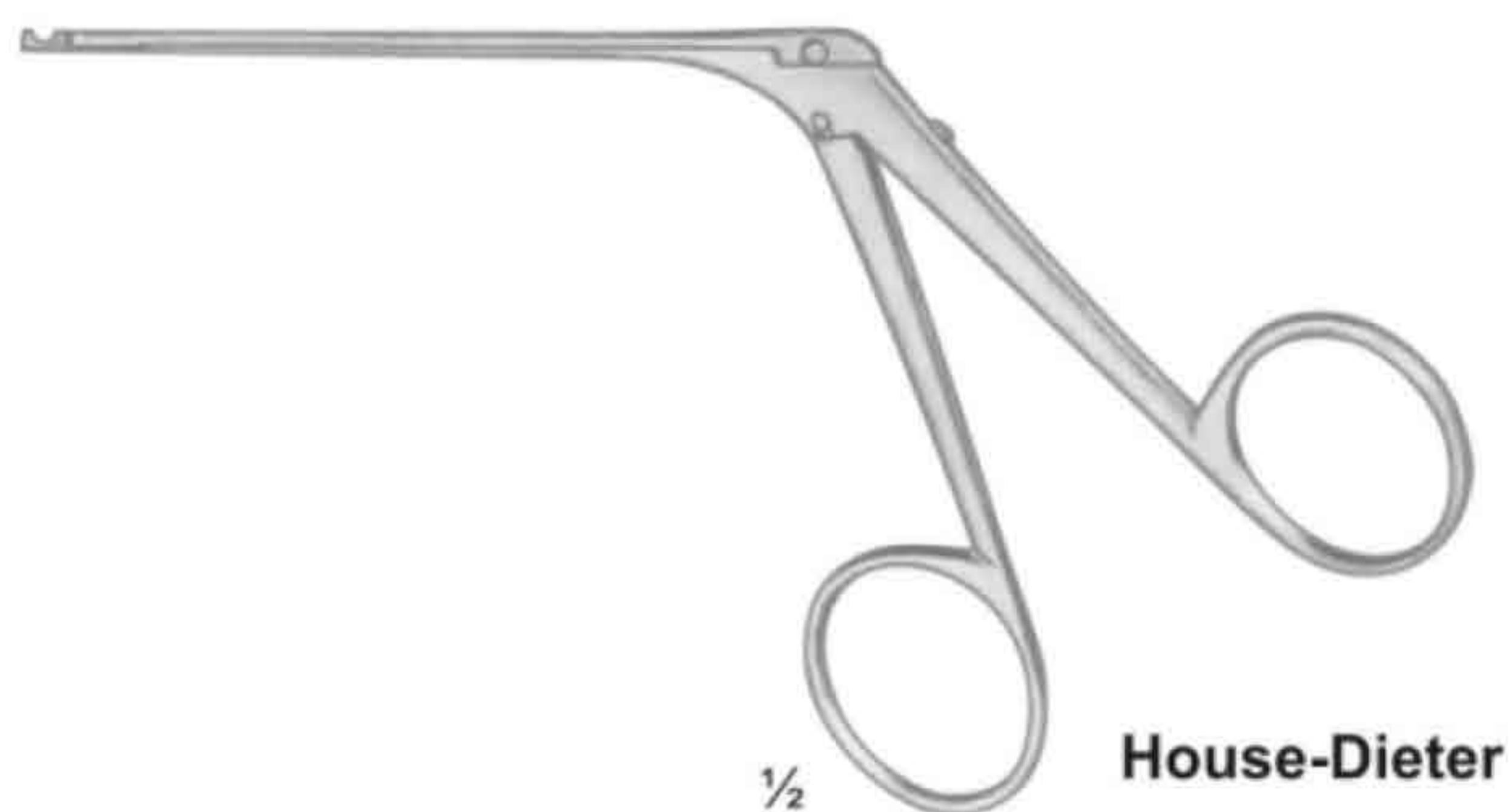
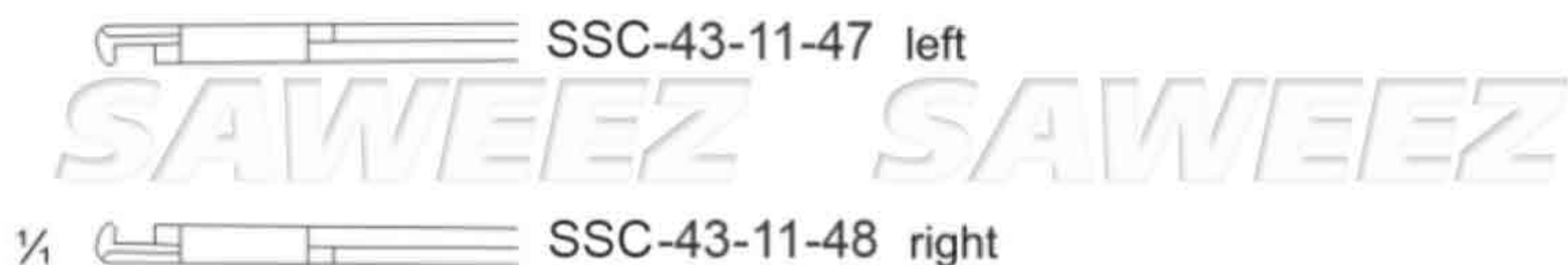
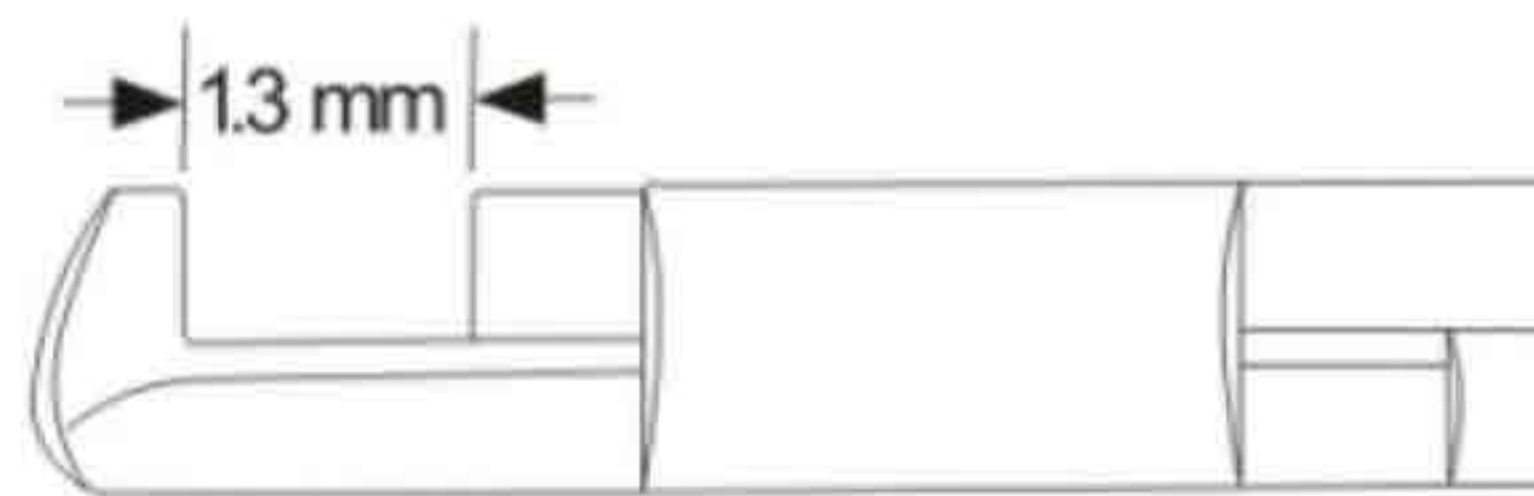


SSC-43-11-44
right

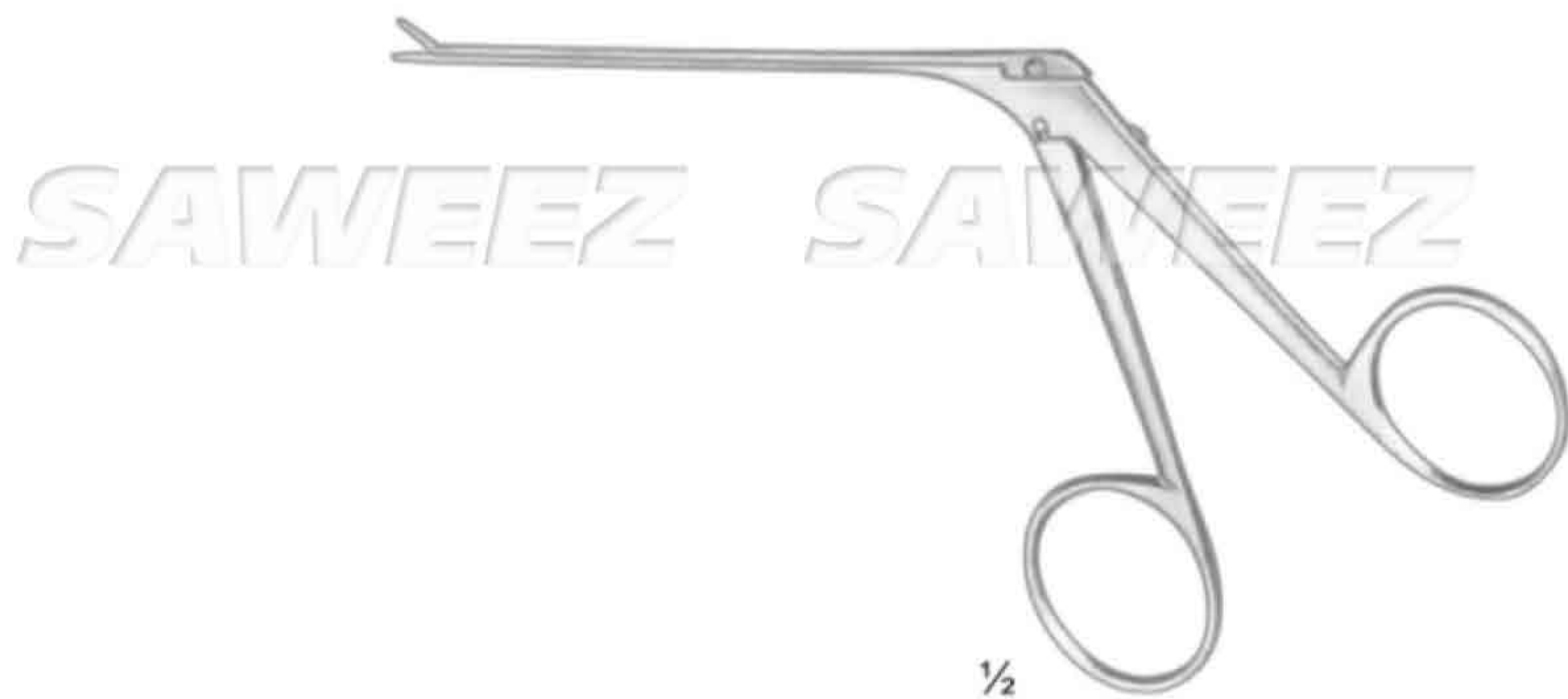


1/2

Juers



SAWEEZ SAWEEZ SAWEEZ SAWEEZ



SAWEEZ SAWEEZ SAWEEZ SAWEEZ

Instrument for introducing teflon pistons



SAWEEZ SAWEEZ SAWEEZ SAWEEZ



Barbara
SSC-43-11-64



SSC-43-11-65



SSC-43-11-66



Rosen
SSC-43-11-67

SAWEEZ SAWEEZ SAWEEZ SAWEEZ



Barbara

¼
25°

- SSC-43-11-68 - 0.3 mm
- SSC-43-11-69 - 0.6 mm
- SSC-43-11-70 - 1.0 mm

45°

- SSC-43-11-71 - 0.3 mm
- SSC-43-11-72 - 0.6 mm
- SSC-43-11-73 - 1.0 mm
- SSC-43-11-74 - 1.2 mm
- SSC-43-11-75 - 1.5 mm
- SSC-43-11-76 - 2.0 mm
- SSC-43-11-77 - 2.5 mm

90°

- SSC-43-11-78 - 0.3 mm
- SSC-43-11-79 - 0.6 mm
- SSC-43-11-80 - 1.0 mm
- SSC-43-11-81 - 1.2 mm
- SSC-43-11-82 - 1.5 mm
- SSC-43-11-83 - 2.0 mm
- SSC-43-11-84 - 2.5 mm

- SSC-43-11-85 - 0.5 mm
- SSC-43-11-86 - 1.0 mm

SAWEEZ SAWEEZ SAWEEZ SAWEEZ



SAWEEZ

SAWEEZ

SAWEEZ

SAWEEZ



Barbara

SSC-43-11-64

SSC-43-11-65

SSC-43-11-66

Rosen

SSC-43-11-67

SAWEEZ

SAWEEZ

SAWEEZ

SAWEEZ



SSC-43-11-68 - 0.3 mm
 SSC-43-11-69 - 0.6 mm
 SSC-43-11-70 - 1.0 mm

SSC-43-11-71 - 0.3 mm
 SSC-43-11-72 - 0.6 mm
 SSC-43-11-73 - 1.0 mm
 SSC-43-11-74 - 1.2 mm
 SSC-43-11-75 - 1.5 mm
 SSC-43-11-76 - 2.0 mm
 SSC-43-11-77 - 2.5 mm

SSC-43-11-78 - 0.3 mm
 SSC-43-11-79 - 0.6 mm
 SSC-43-11-80 - 1.0 mm
 SSC-43-11-81 - 1.2 mm
 SSC-43-11-82 - 1.5 mm
 SSC-43-11-83 - 2.0 mm
 SSC-43-11-84 - 2.5 mm

SSC-43-11-85 - 0.5 mm
 SSC-43-11-86 - 1.0 mm

SAWEEZ

SAWEEZ



SAWEEZ

SAWEEZ

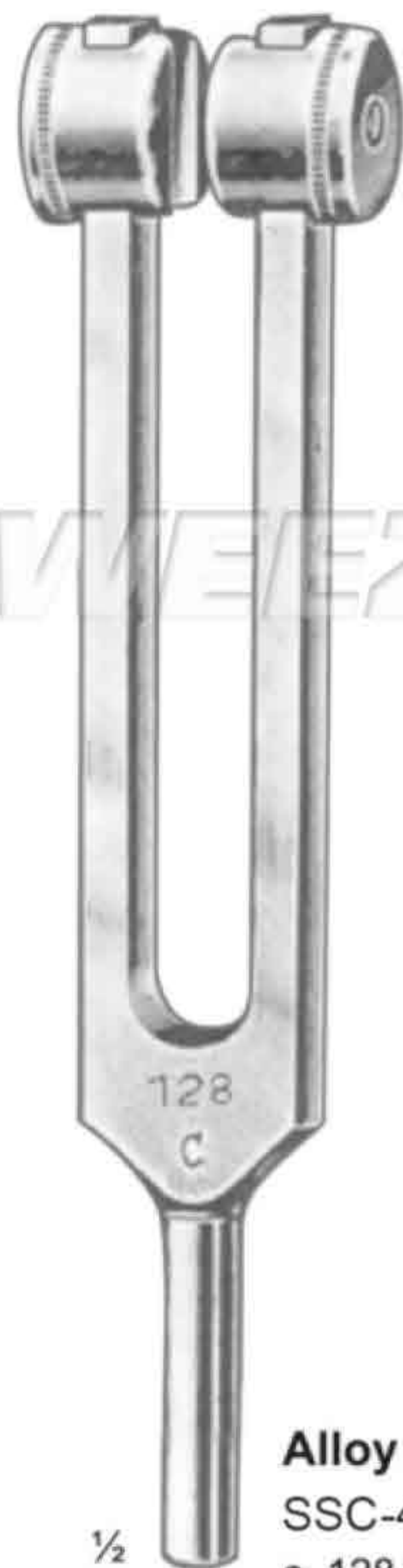
1/2

Barbara



	①		①		①		
		SSC-43-11-87 = 3 mm ø		SSC-43-11-91 = 4 mm ø		SSC-43-11-97 = 4.0 mm ø	
	①		②		②		
		SSC-43-11-88 = 4 mm ø		SSC-43-11-92 = 5 mm ø		SSC-43-11-98 = 5.0 mm ø	
	①		③		③		
		SSC-43-11-89 = 5 mm ø			SSC-43-11-93 = 6 mm ø		
	②		④		④		
			SSC-43-11-94 = 7.5 mm ø		SSC-43-12-00 = 7.5 mm ø		
Hartmann for children			Hartmann for adults			Toynbee for adults	
Pieces Fig.			Pieces Fig.			Pieces Fig.	
Set of 3 0-2		SSC-43-11-90	Set of 3 2-4		SSC-43-11-95	Set of 3 2-4	SSC-43-12-01
			Set of 4 1-4		SSC-43-11-96	Set of 4 1-4	SSC-43-12-02

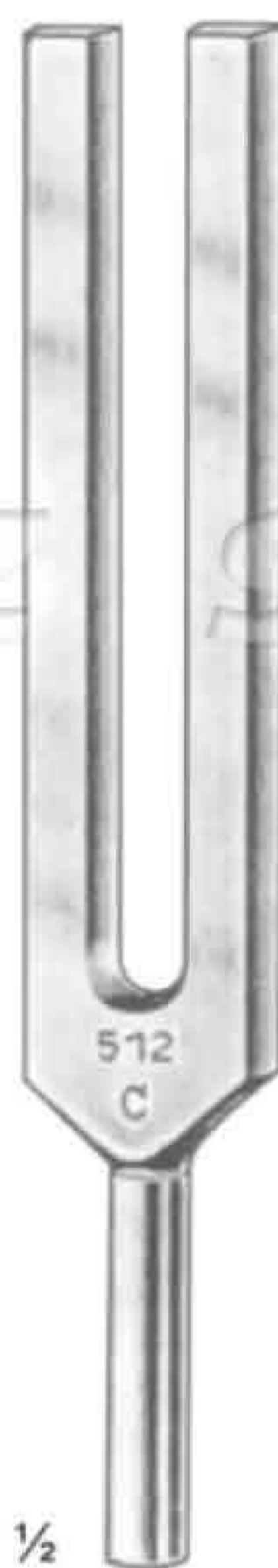
	①		①		○		
		SSC-43-12-03 = 4.5 mm ø		SSC-43-12-08 = 4.5 mm ø		SSC-43-12-13 = 5.5 x 6.5 mm	
	②		②		○		
		SSC-43-12-04 = 5.5 mm ø		SSC-43-12-09 = 5.5 mm ø		SSC-43-12-14 = 6.5 x 7.5 mm	
	③		③		○		
		SSC-43-12-05 = 6.5 mm ø			SSC-43-12-10 = 6.5 mm ø		
	④		④		○		
		SSC-43-12-06 = 7.5 mm ø		SSC-43-12-11 = 7.5 mm ø		SSC-43-12-15 = 7.5 x 8.5 mm	
Gruber for adults			Gruber for adults			Zollner for adults	
Pieces Fig.			Pieces Fig.			Pieces	
Set of 3 2-4		SSC-43-12-07	Set of 4 1-4		SSC-43-12-12	Set of 6	SSC-43-12-19
							SSC-43-12-17 = 9.5 x 10.5 mm
							○
							○
							Aluminium black SSC-43-12-18 = 10.5 x 11.5 mm



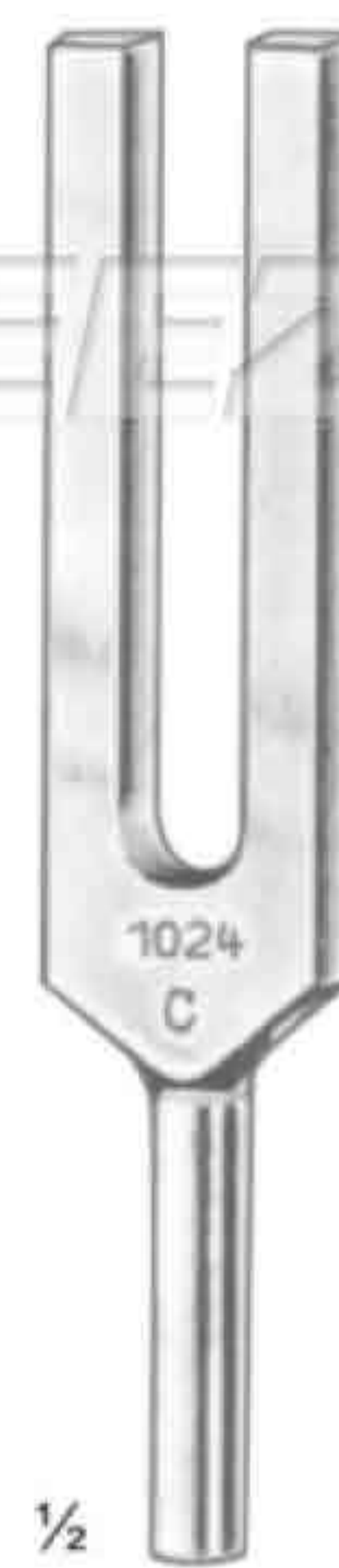
Alloy
SSC-43-12-20
c 128



Alloy
SSC-43-12-21
c¹ 256



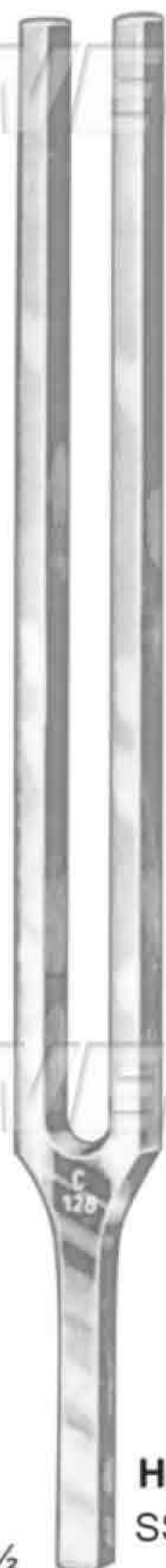
Alloy
SSC-43-12-22
c² 512



Alloy
SSC-43-12-23
c³ 1024



Alloy
SSC-43-12-24
c⁴ 2048



Hartmann
SSC-43-12-25
c 128



Hartmann
SSC-43-12-26
c¹ 256



Hartmann
SSC-43-12-27
c² 512



Hartmann
SSC-43-12-28
c³ 1024



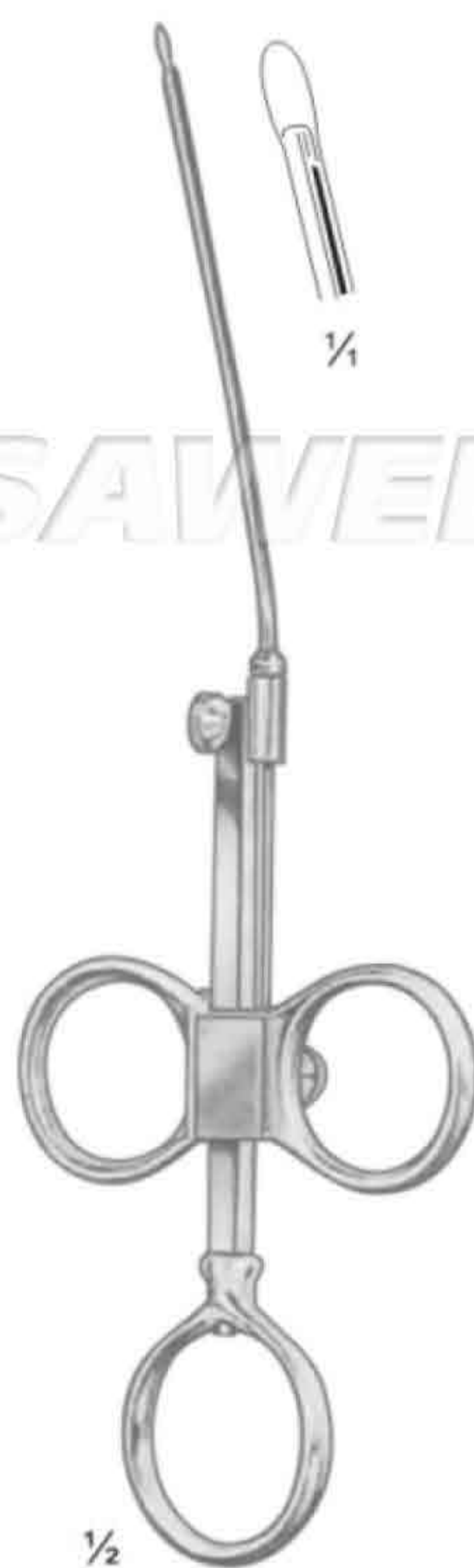
Hartmann
SSC-43-12-29
c⁴ 2048



Hartmann
SSC-43-12-30
c⁵ 4096



Krause
SSC-43-12-31



Krause-Voss
SSC-43-12-32



Troeltsch (Wilde)
SSC-43-12-33
11.0 cm / 4 1/2"



Troeltsch (Wilde)
SSC-43-12-34
12.0 cm / 4 3/4"



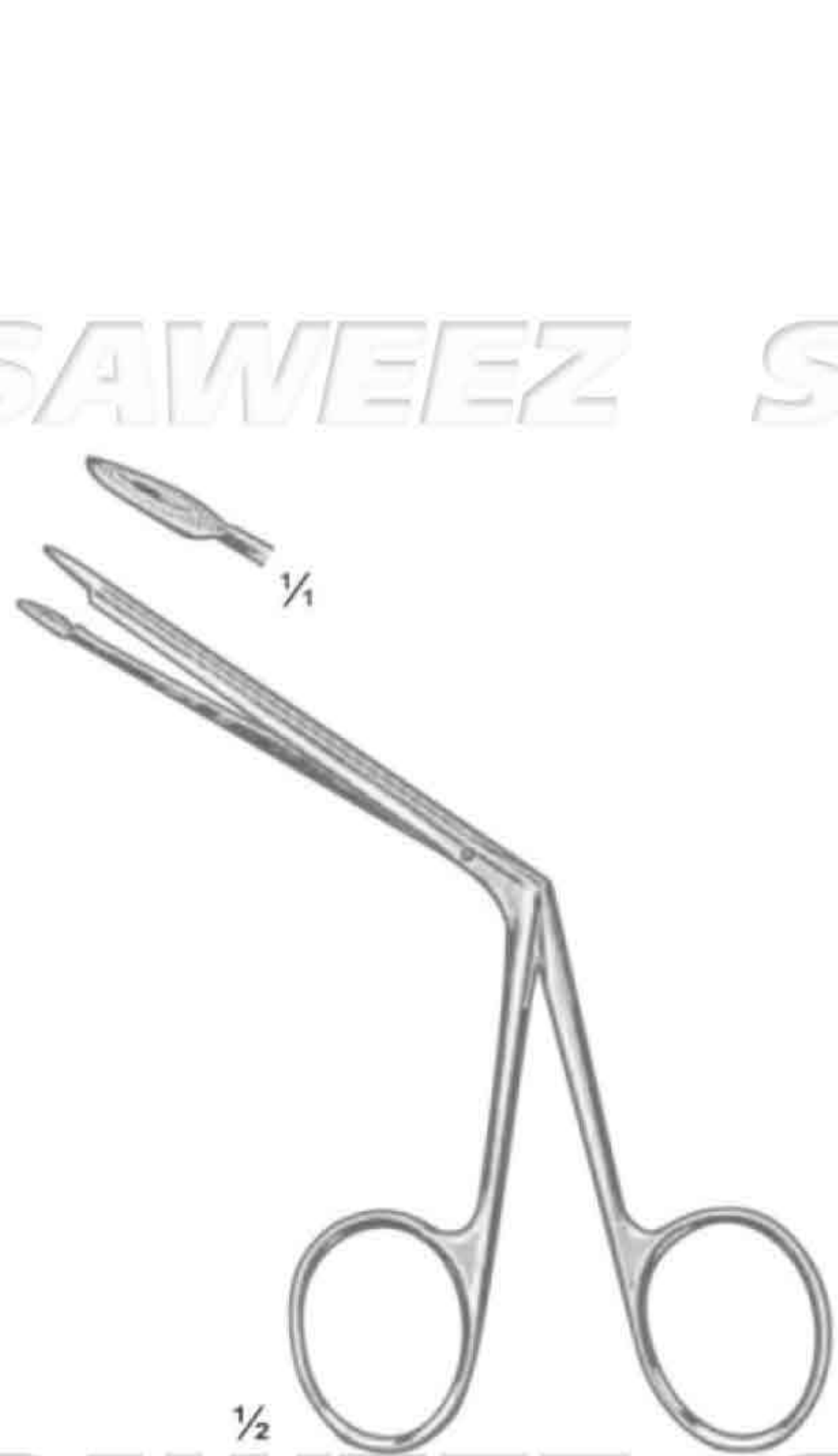
Troeltsch (Wilde)
SSC-43-12-35
13.0 cm / 5"



Lucae
SSC-43-12-36
14.0 cm / 5 1/2"



Jansen
SSC-43-12-37- 16.0 cm / 6 1/4"
SSC-43-12-38- 20.0 cm / 8"



Littauer
SSC-43-12-39
12.0 cm / 4¾"



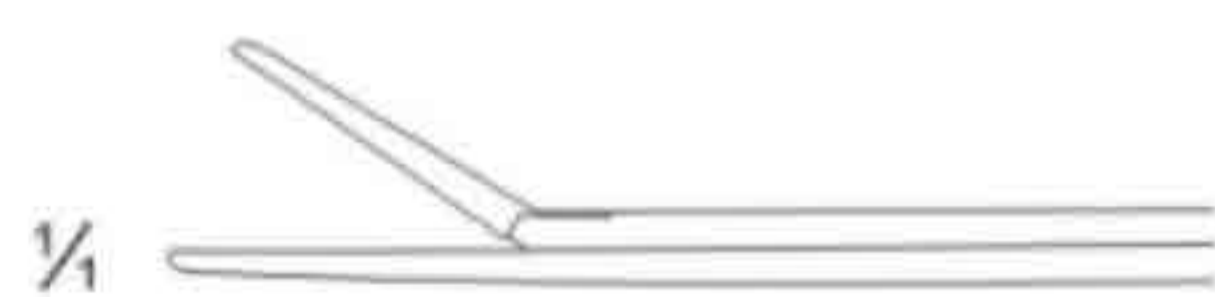
Hartmann
SSC-43-12-40
12.0 cm / 4¾"

fine pattern

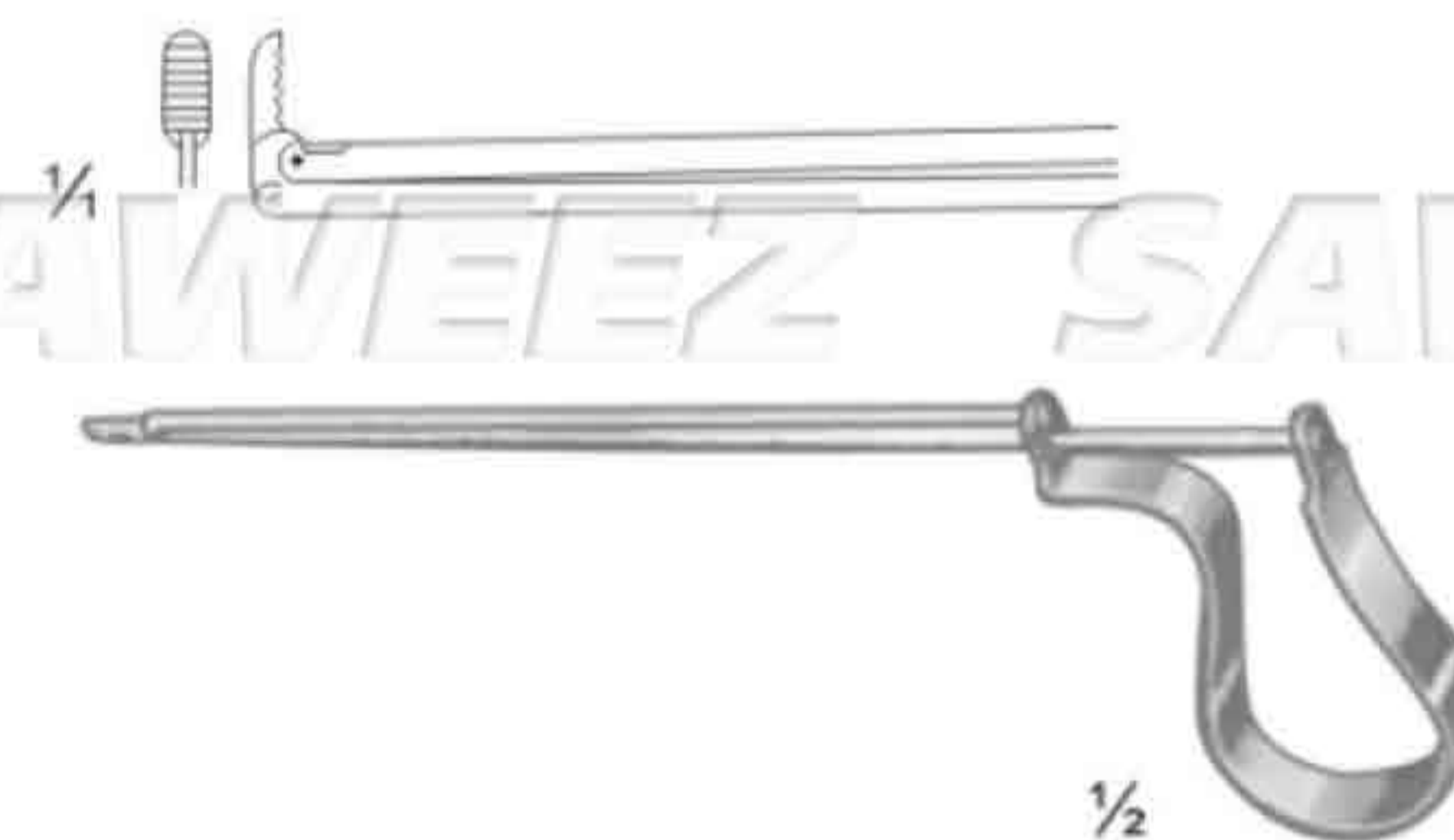


Hartmann
SSC-43-12-41
14.0 cm / 5½"

standard pattern



Buck
SSC-43-12-42



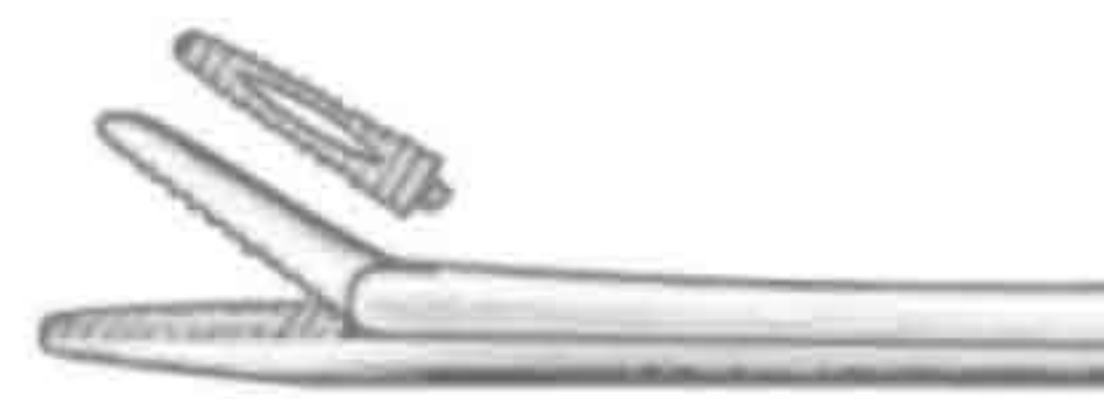
Quire
SSC-43-12-43



Hartmann-Wullstein
SSC-43-12-44
8.5 cm / 3 1/2"



Hartmann-Wullstein
SSC-43-12-45
8.5 cm / 3 1/2"



Hartmann
SSC-43-12-46 - 8.5 cm / 3 1/2"
SSC-43-12-47 - 14.0 cm / 5 1/2"
SSC-43-12-48 - 16.5 cm / 6 1/2"



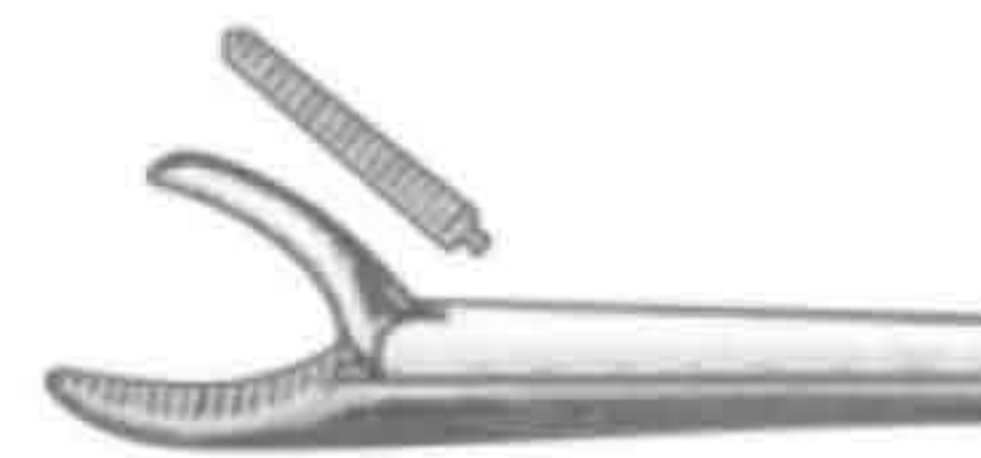
Hartmann
SSC-43-12-49 - 8.5 cm / 3 1/2"
SSC-43-12-50 - 14.5 cm / 5 1/2"



Hartmann-Noyes
SSC-43-12-51 - 9.0 cm / 3 1/2"



Hartmann-Noyes
SSC-43-12-52 - 9.0 cm / 3 1/2"



Hartmann-Weingartner
SSC-43-12-53 - 8.5 cm / 3 1/2"



Hartmann
SSC-43-12-54 - 8.5 cm / 3 1/2"



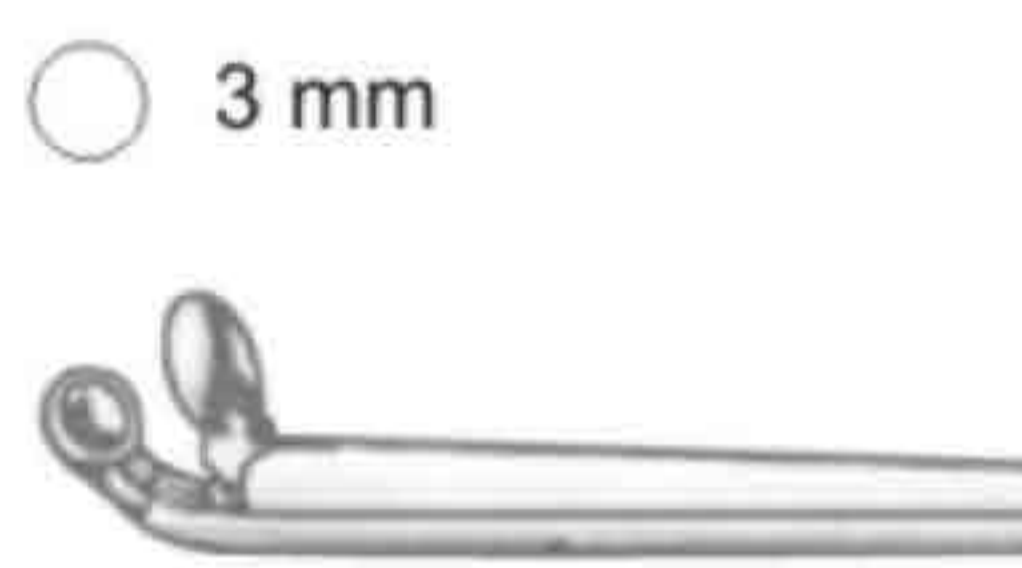
○ 2 mm

○ 2.5 mm



○ 3 mm

Hartmann
SSC-43-12-55 - 2 mm ø
SSC-43-12-56 - 2.5 mm ø
SSC-43-12-57 - 3 mm ø



○ 3 mm

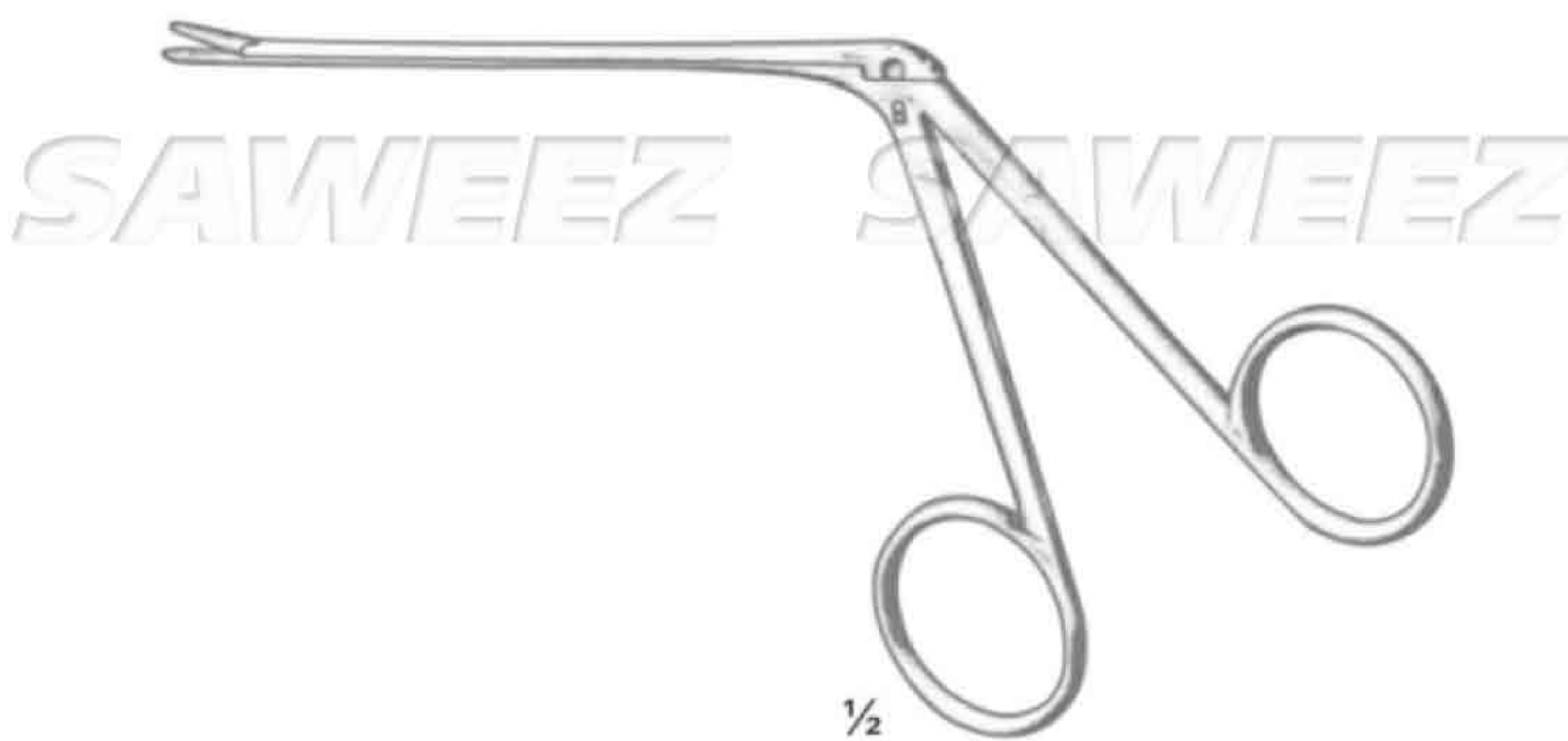
Hartmann
SSC-43-12-58
8.5 cm / 3 1/2"



Struempel
SSC-43-12-59
8.5 cm / 3 1/2"



Hartmann
SSC-43-12-60
8.5 cm / 3 1/2"



1/2



Hartmann
SSC-43-12-61
8.5 cm / 3 1/2"



○ 2 mm

Hartmann-Hoffmann
SSC-43-12-62
8.5 cm / 3 1/2"



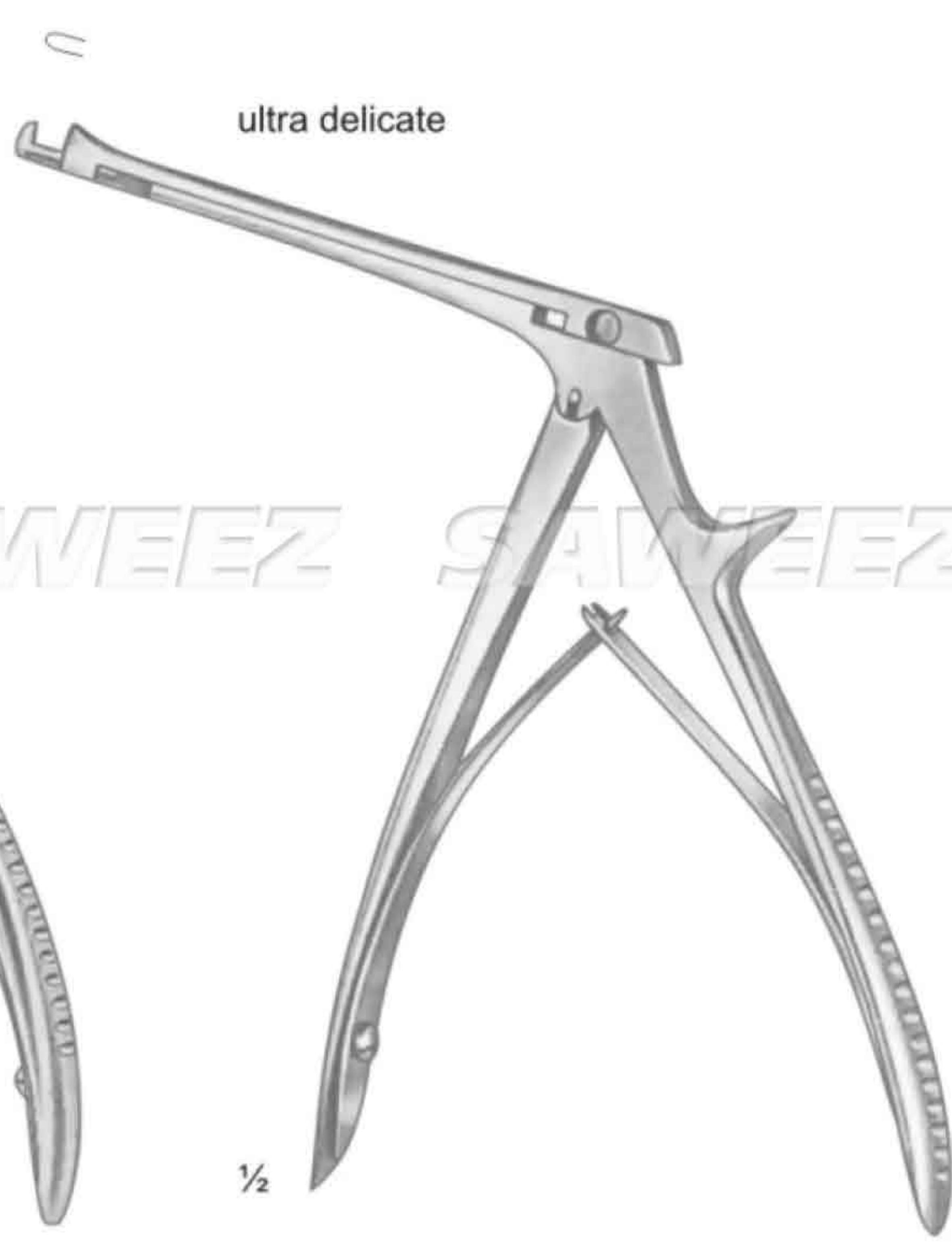
SAWEEZ SAWEEZ SAWEEZ SAWEEZ



Citelli
SSC-43-12-63

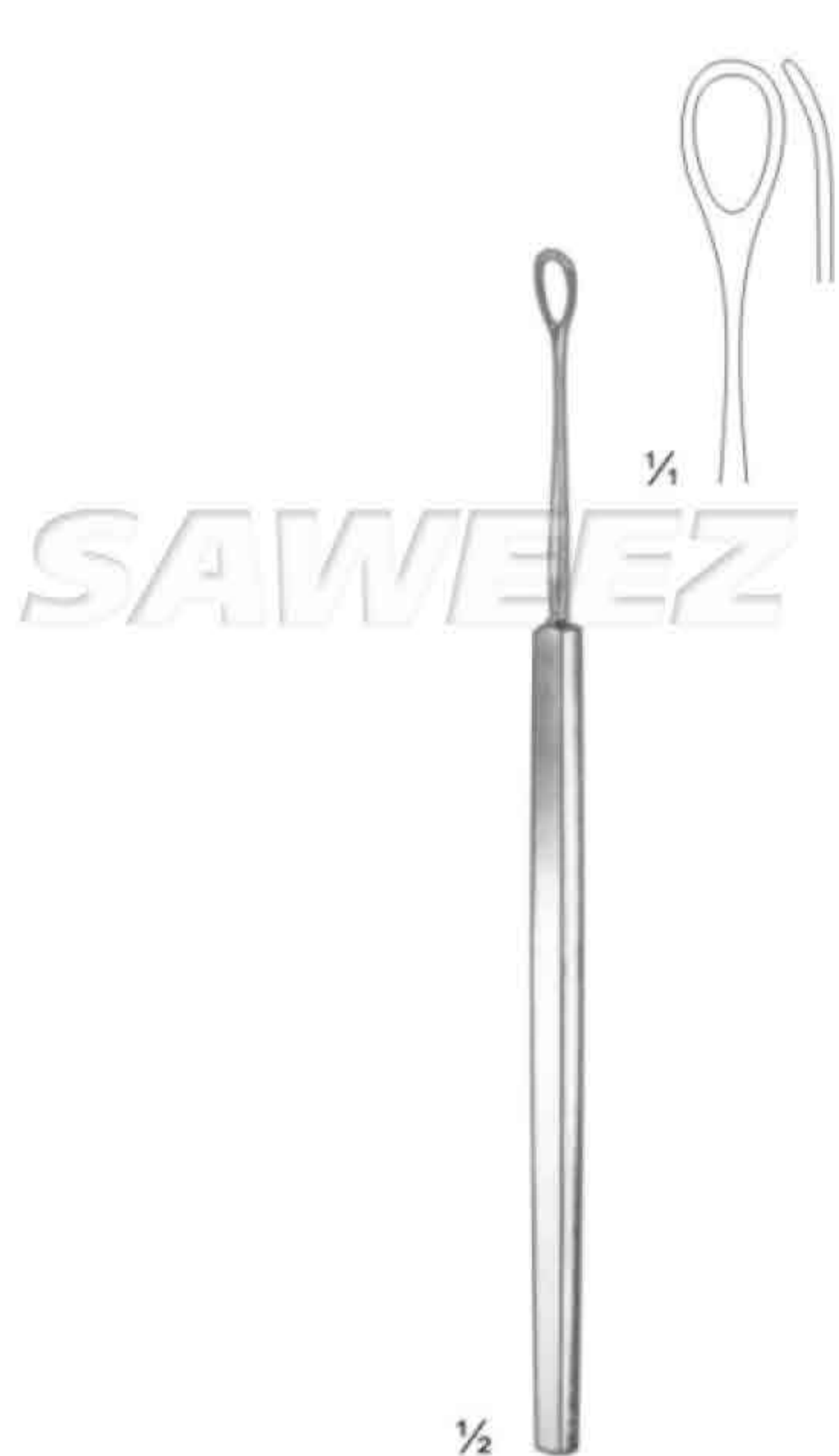


Beyer
SSC-43-12-64



Beyer
SSC-43-12-65

SAWEEZ SAWEEZ SAWEEZ SAWEEZ



Langenbeck
SSC-43-12-66
13.3 cm / 5 1/4"



Shapleigh
13.3 cm / 5 1/4"

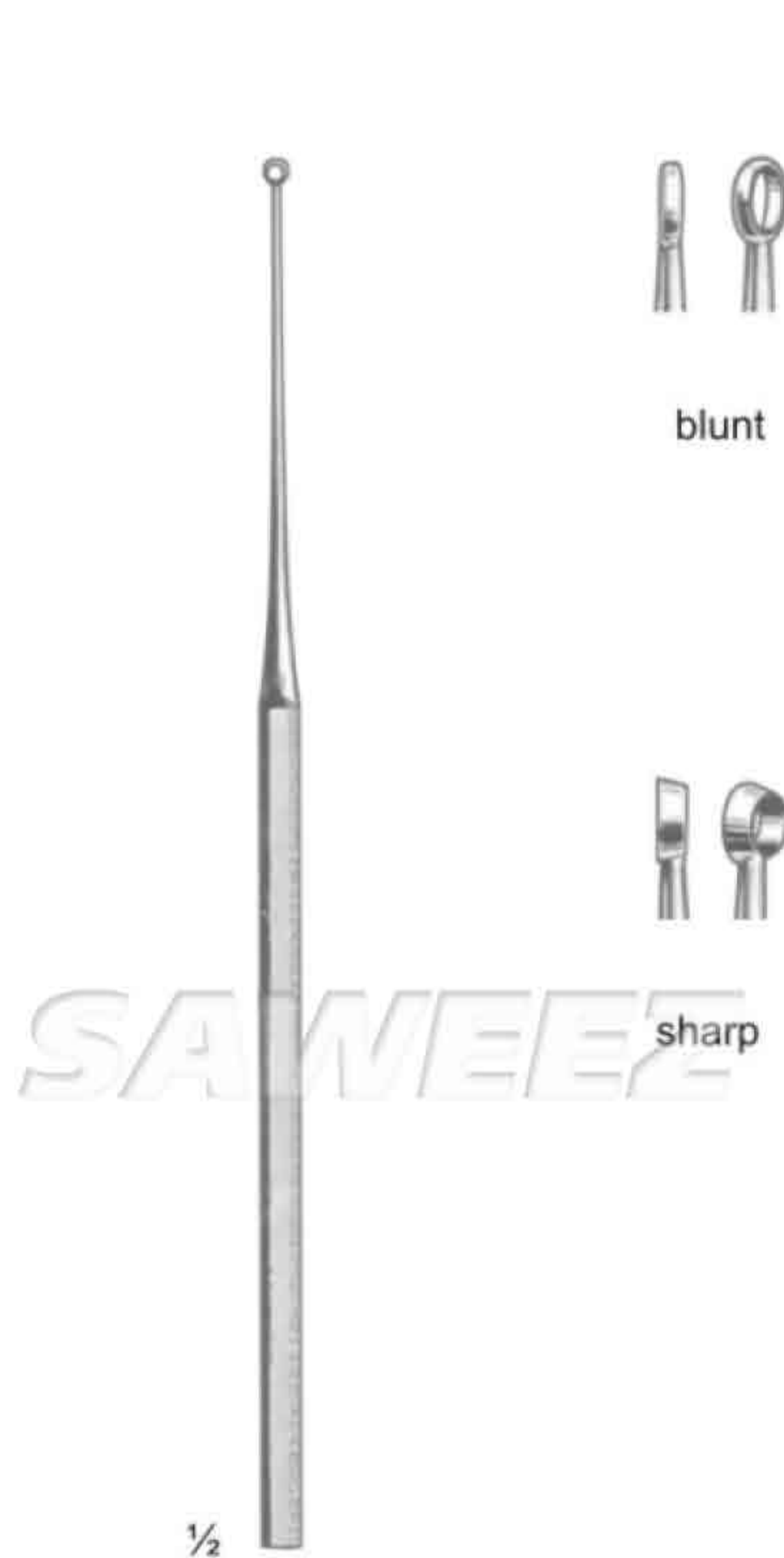
SSC-43-12-67

SSC-43-12-68

SSC-43-12-69

SSC-43-12-70

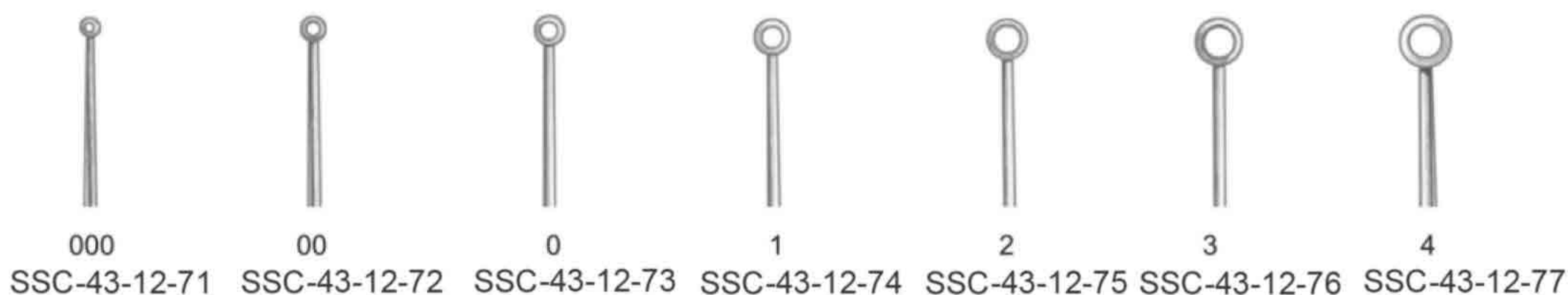
SAWEEZ SAWEEZ SAWEEZ SAWEEZ



Buck
16.5 cm / 6 1/2"



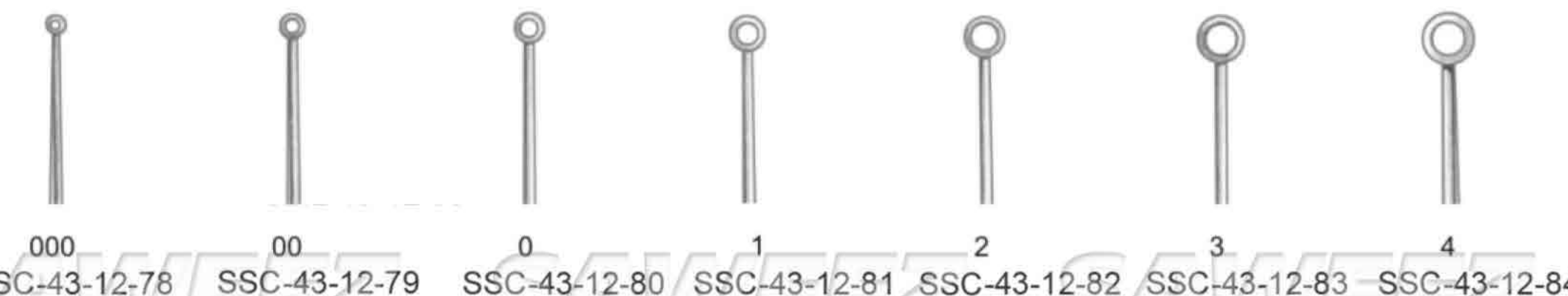
blunt



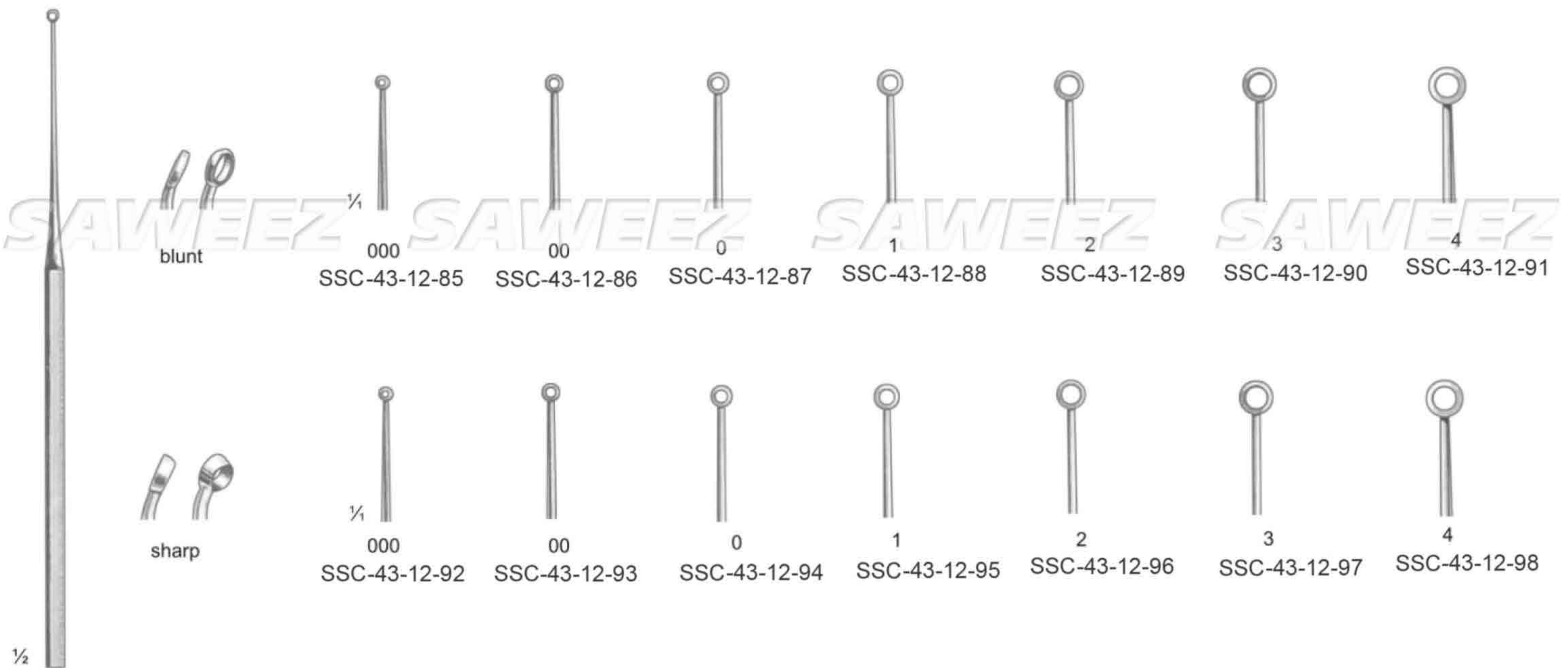
000 SSC-43-12-71 00 SSC-43-12-72 0 SSC-43-12-73 1 SSC-43-12-74 2 SSC-43-12-75 3 SSC-43-12-76 4 SSC-43-12-77



sharp



000 SSC-43-12-78 00 SSC-43-12-79 0 SSC-43-12-80 1 SSC-43-12-81 2 SSC-43-12-82 3 SSC-43-12-83 4 SSC-43-12-84



Buck
16.5 cm / 6 1/2"



Coxter
SSC-43-12-99
15.0 cm / 6"

blunt

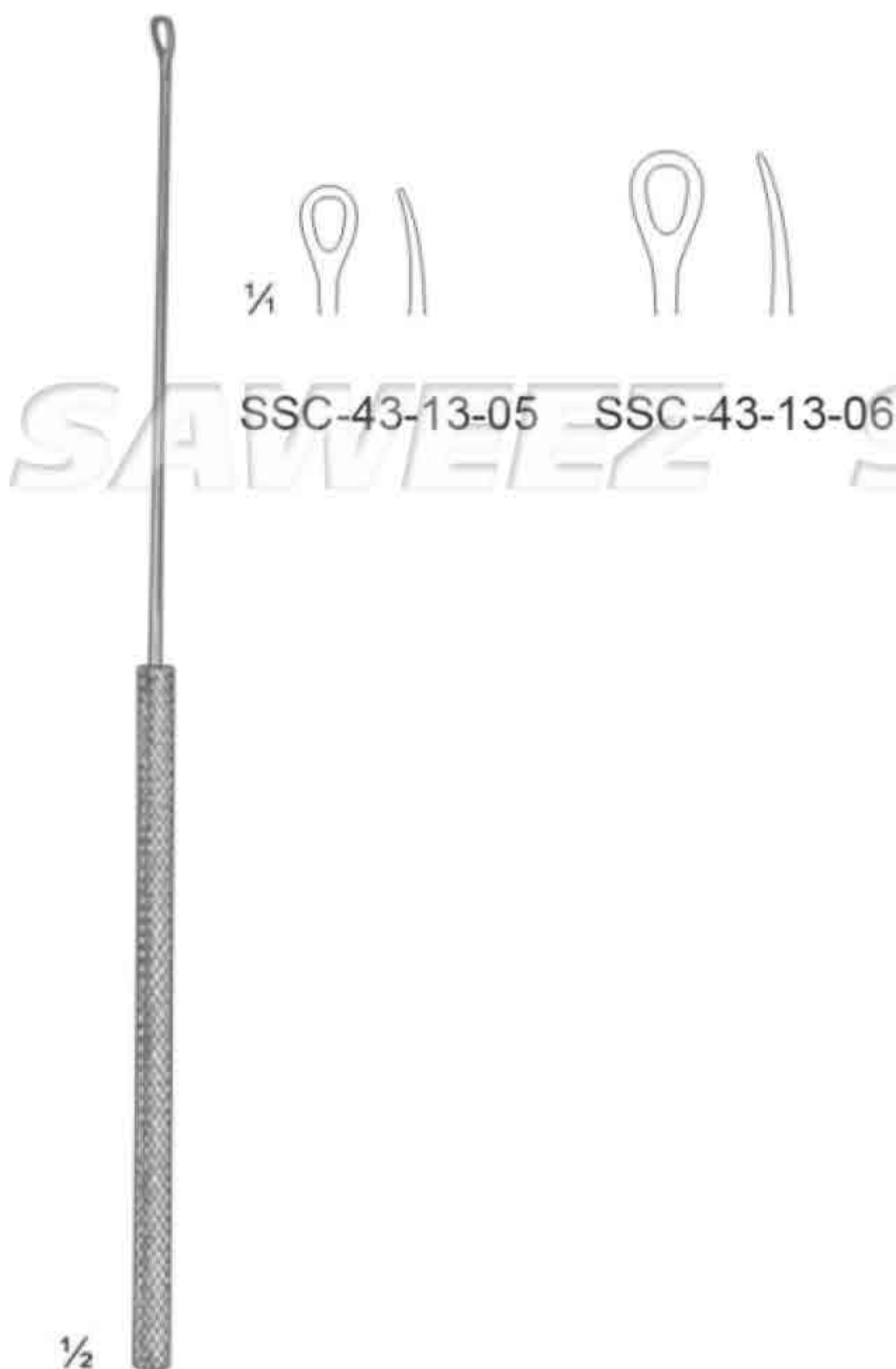
Special Model
SSC-43-12-00
17.0 cm / 6 3/4" blunt
SSC-43-13-01
17.0 cm / 6 3/4" sharp

Jansen
SSC-43-13-02
15.0 cm / 6" sharp

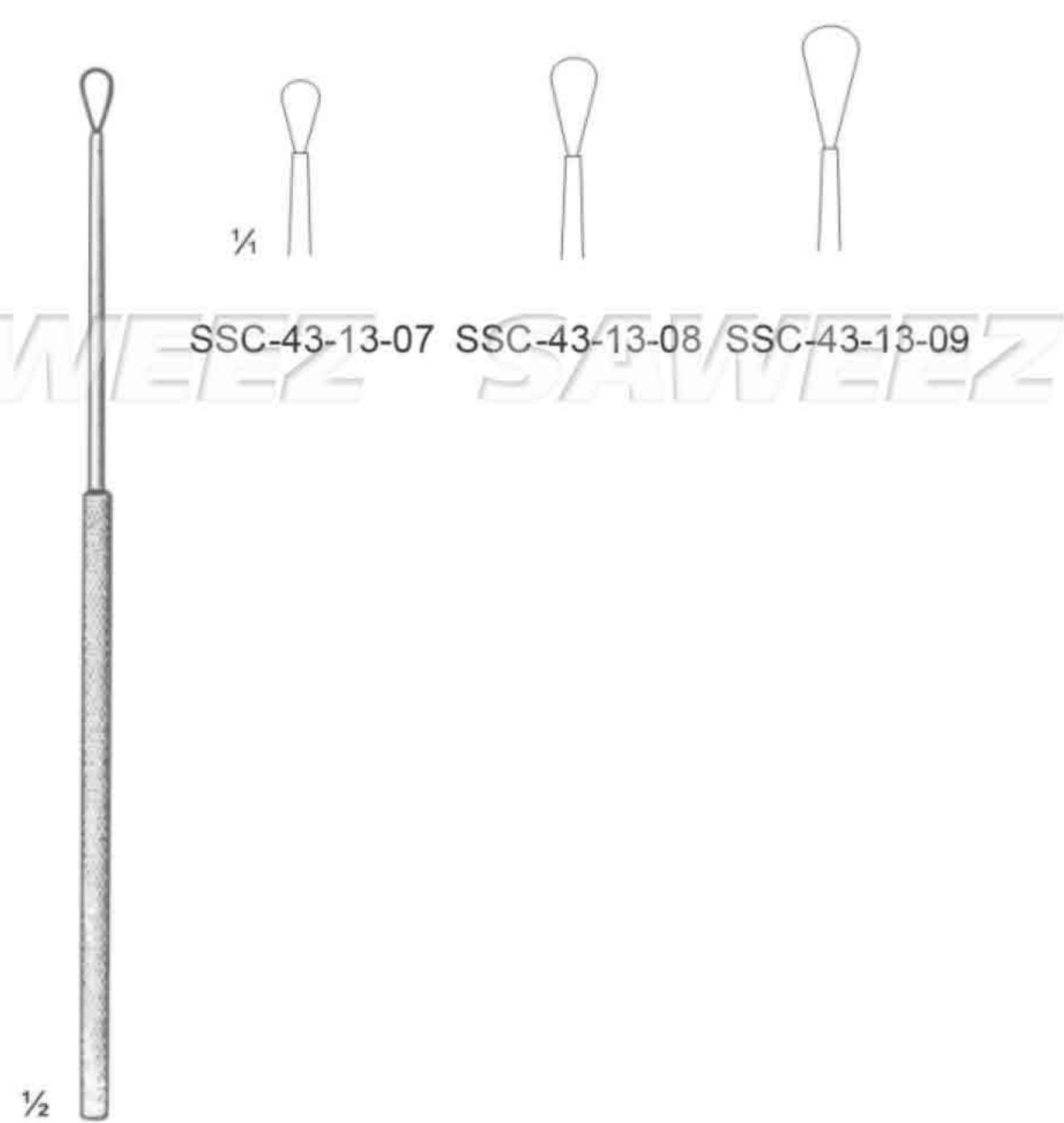
Barth
SSC-43-13-03
18.5 cm / 7 1/4" sharp



Gross
SSC-43-13-04
12.0 cm / 4 3/4"
blunt



16.0 cm / 6 1/4"



Billeau
16.5 cm / 6 1/2"



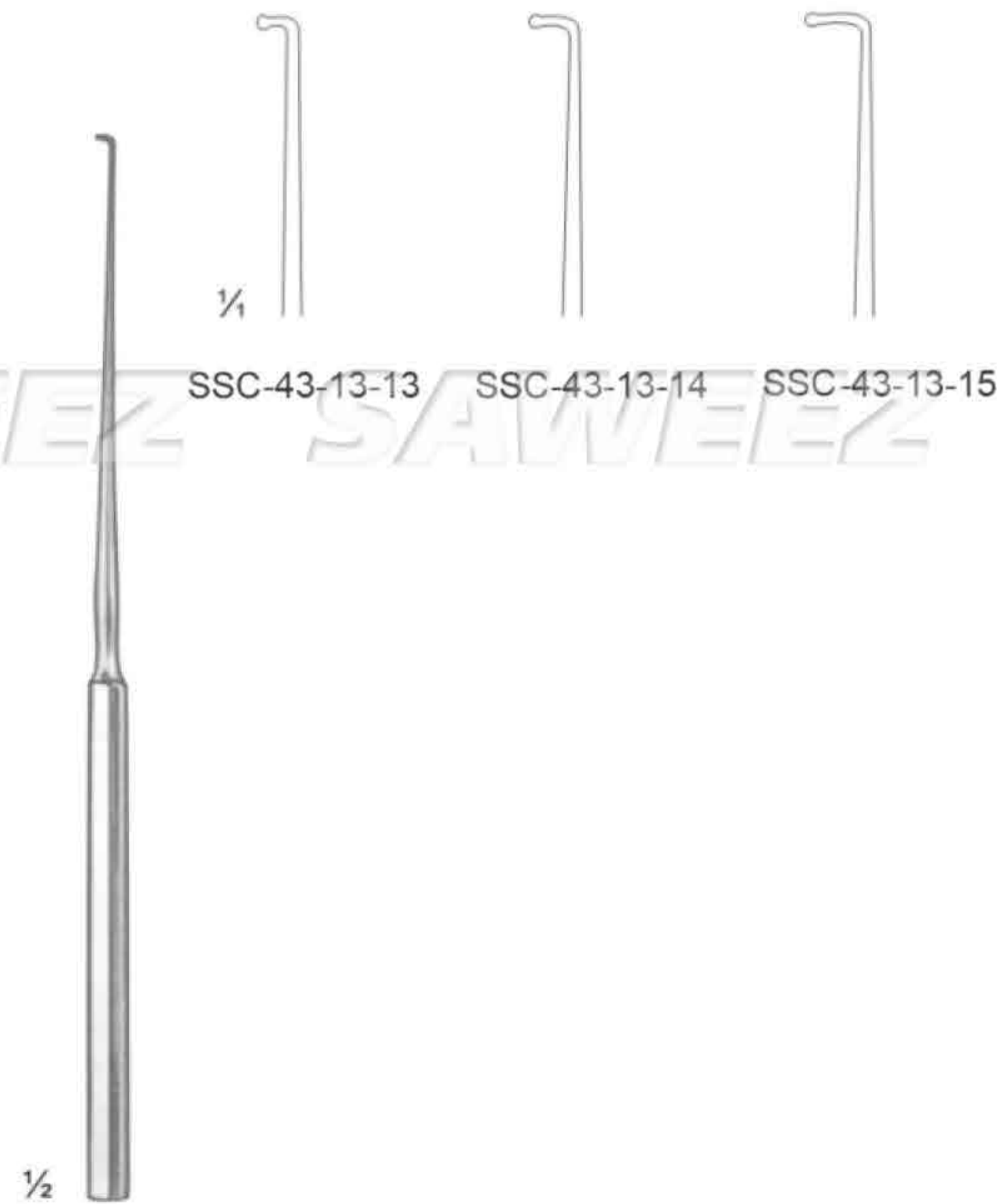
Moldenhauer
SSC-43-13-10
16.5 cm / 6 1/2"



Zaufal
SSC-43-13-11
16.0 cm / 6 1/4"



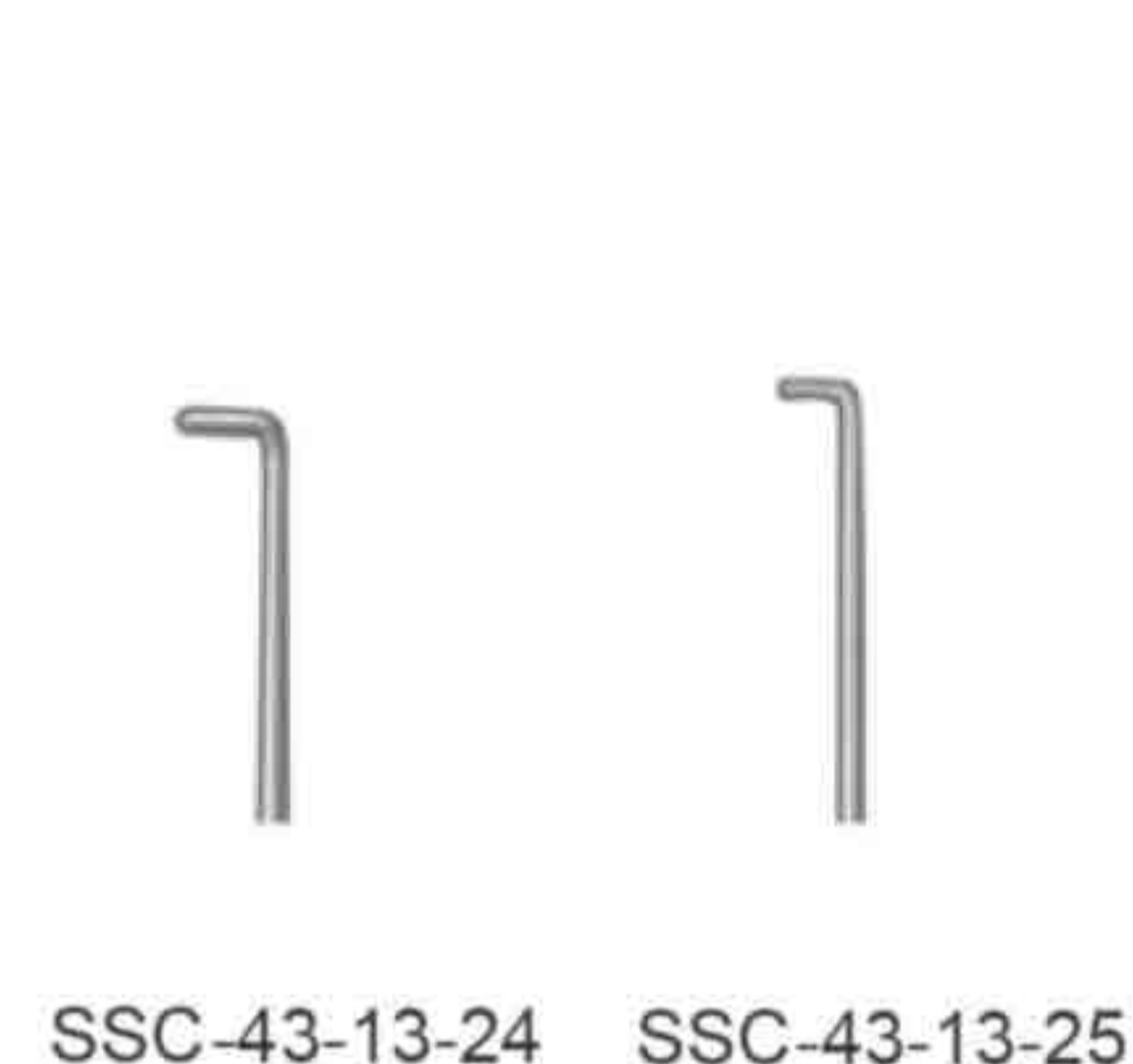
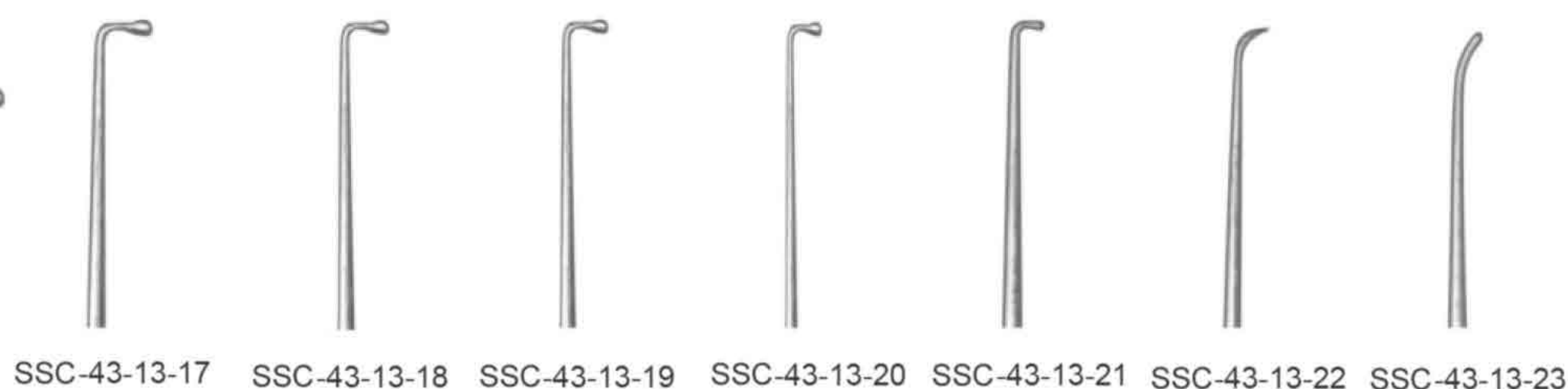
Hartman
SSC-43-13-12
16.0 cm / 6 1/4"



Lucae
14.0 cm / 5½"



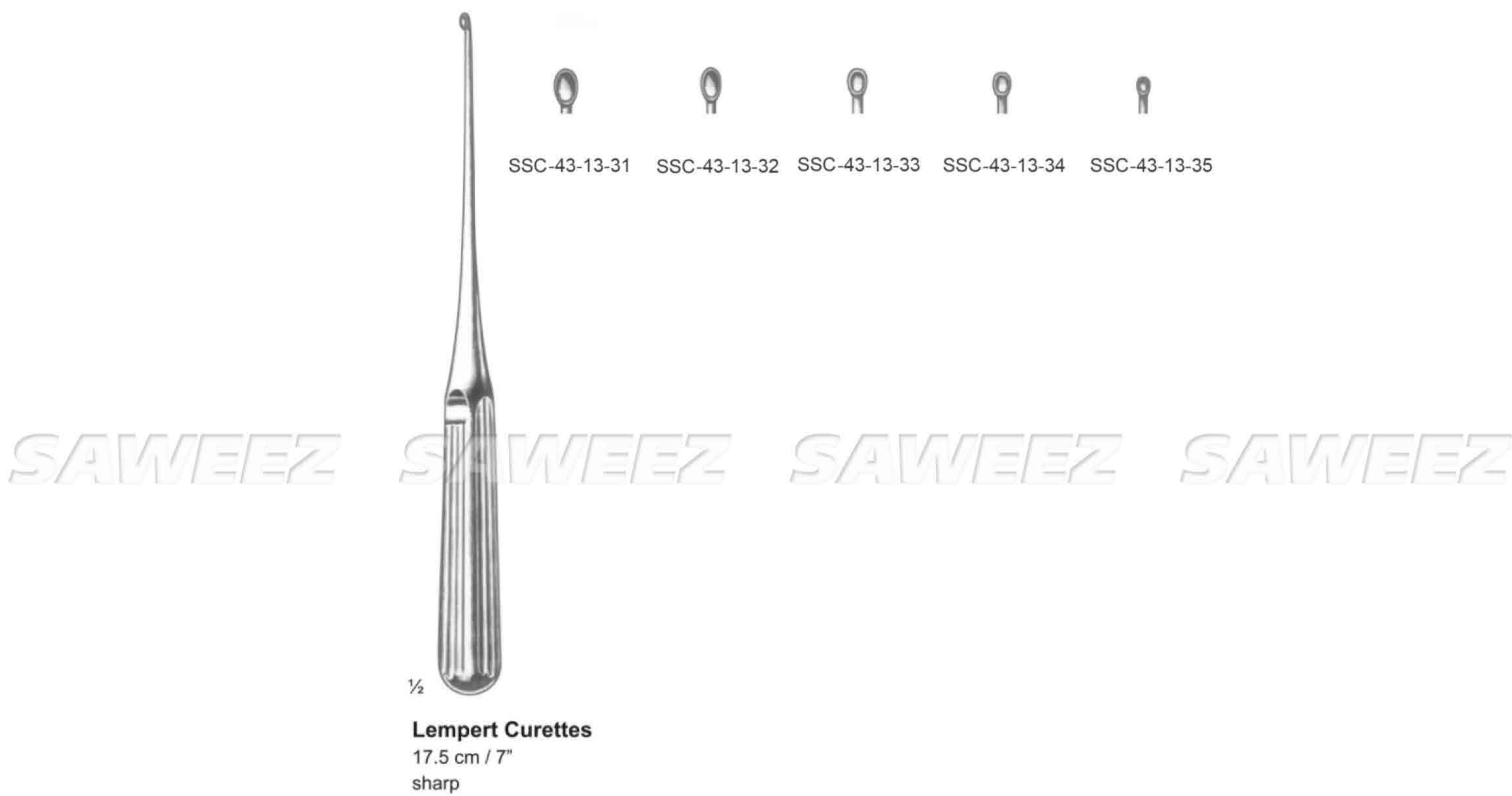
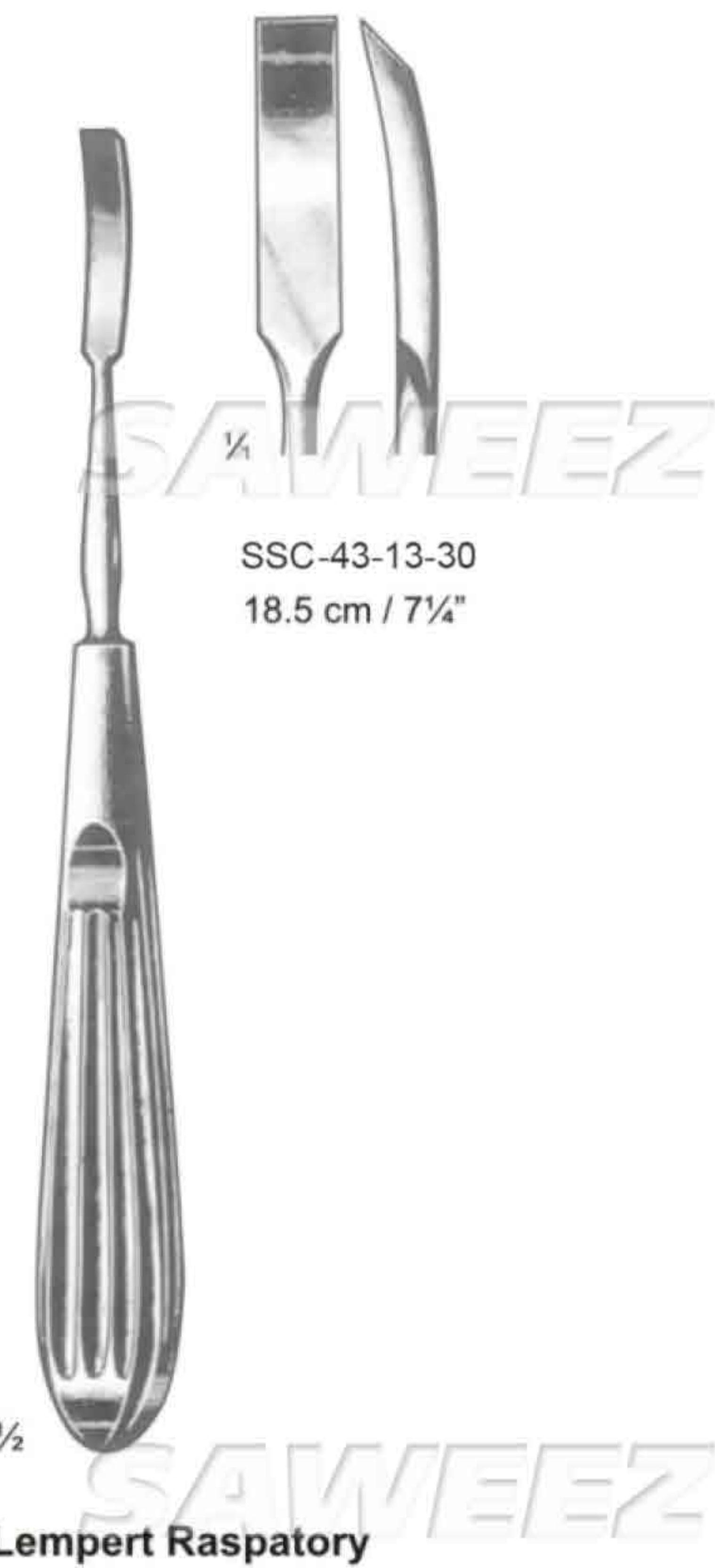
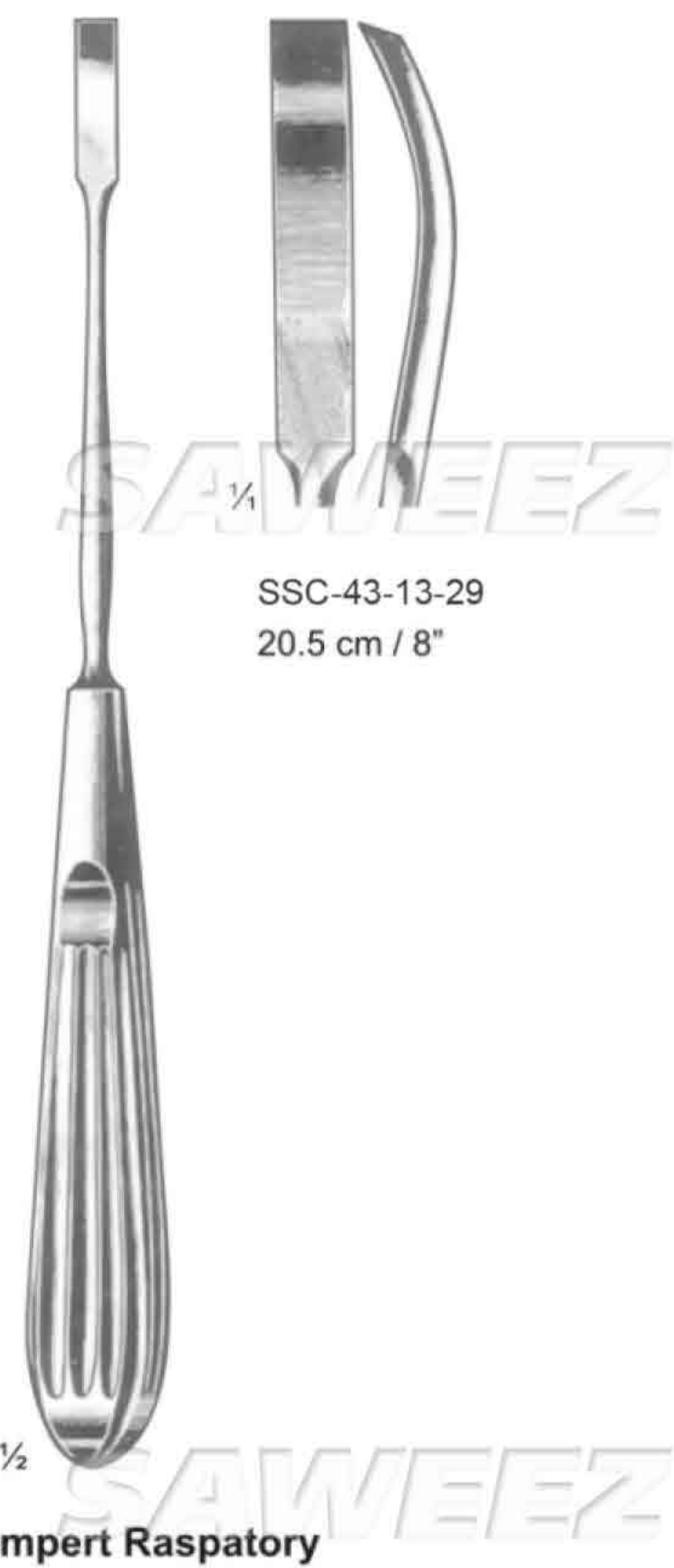
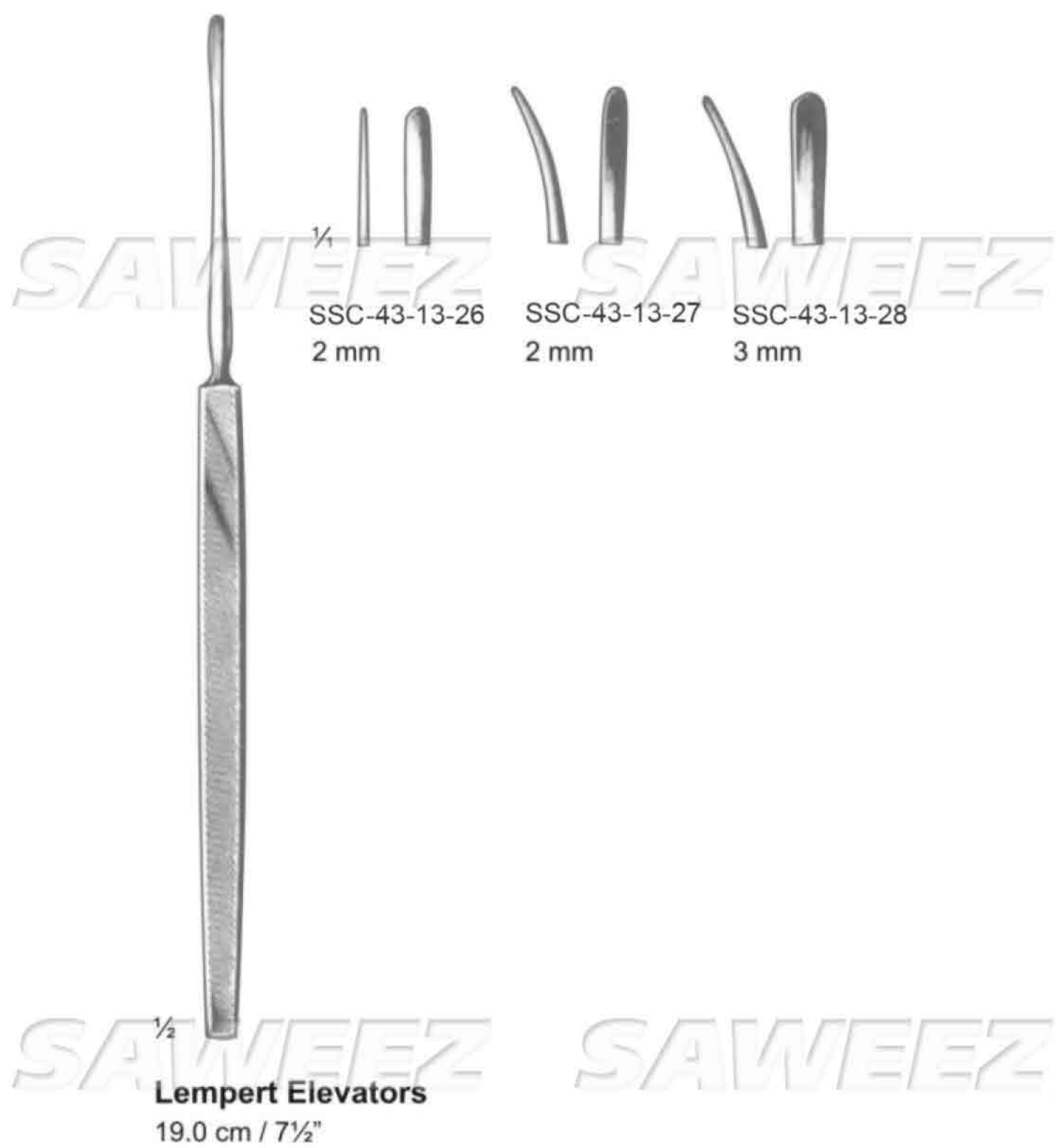
Allport
SSC-43-13-16
16.0 cm / 6¼"



Wagener
14.0 cm / 5½"



Day
16.0 cm / 6¼"





1/2

Heister
SSC-45-11-11
13.0 cm / 5"



1/2

Molt
SSC-45-11-12
11.0 cm / 4 1/2"



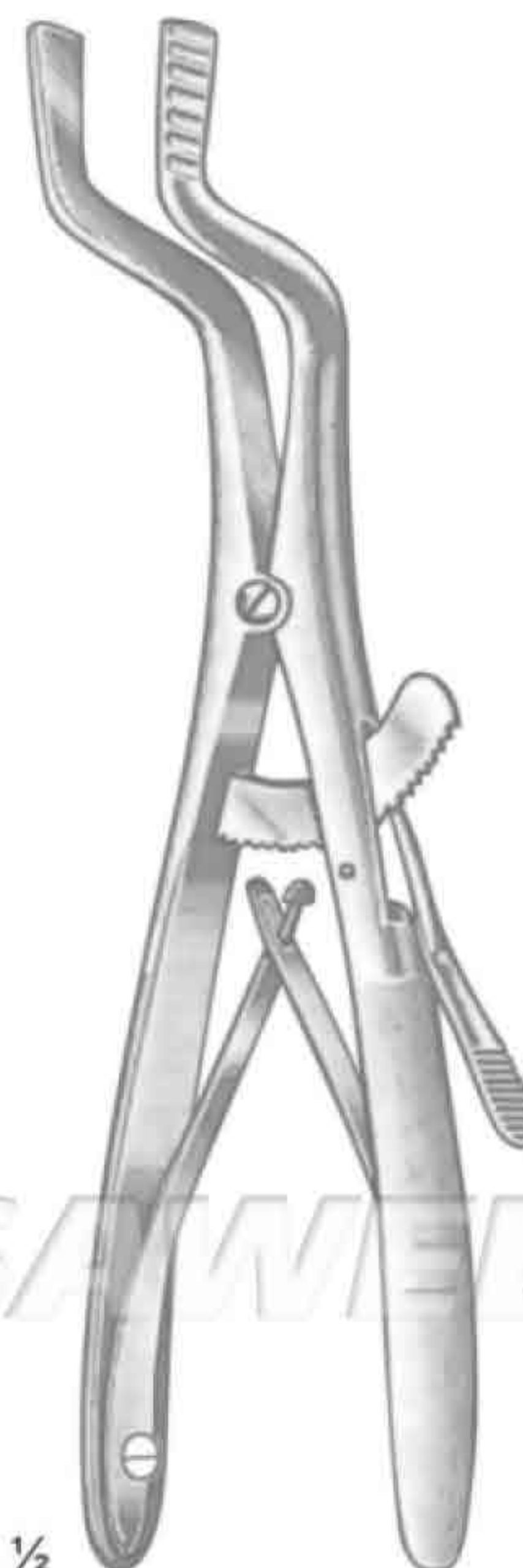
1/2

Molt
SSC-45-11-13
14.0 cm / 5 1/2"



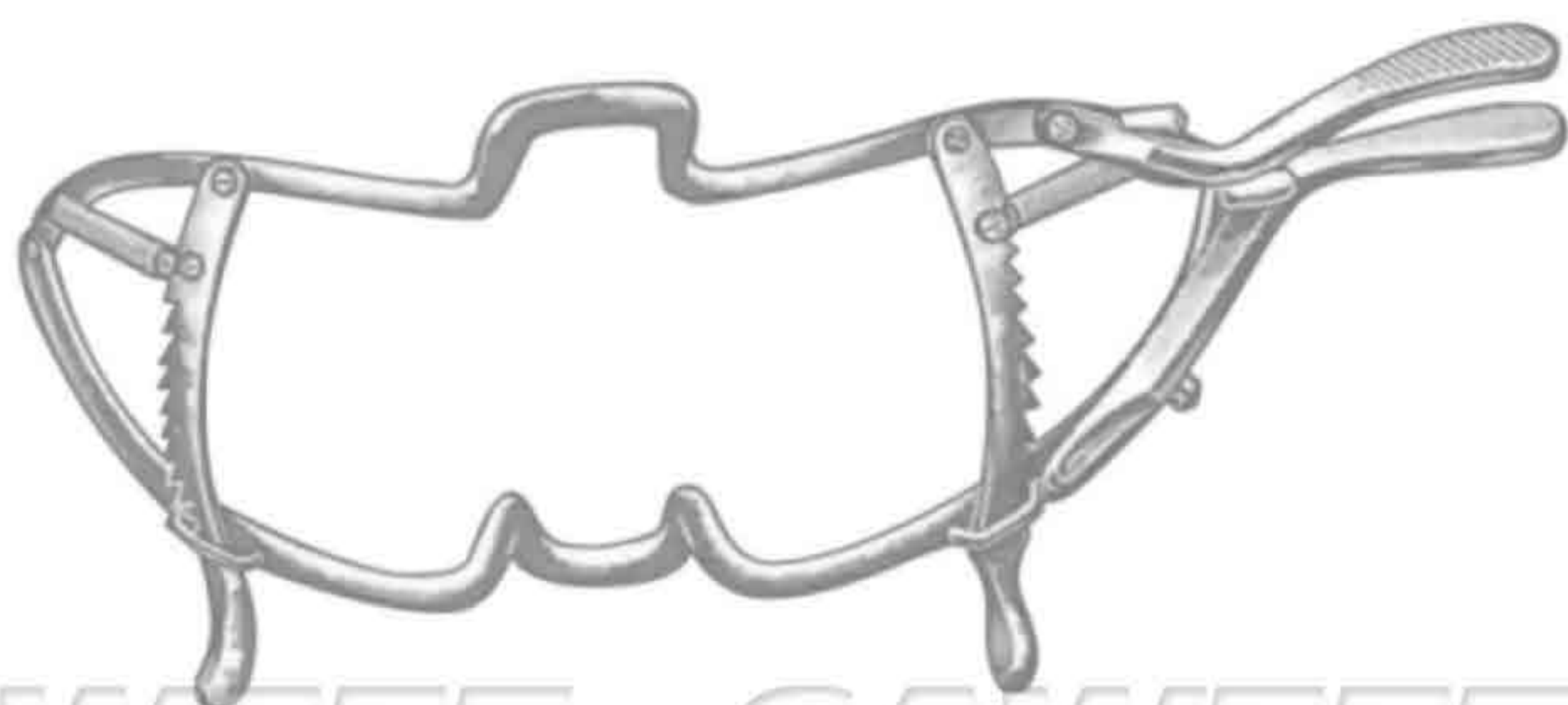
1/2

Denhart
SSC-45-11-14
12.0 cm / 4 3/4"

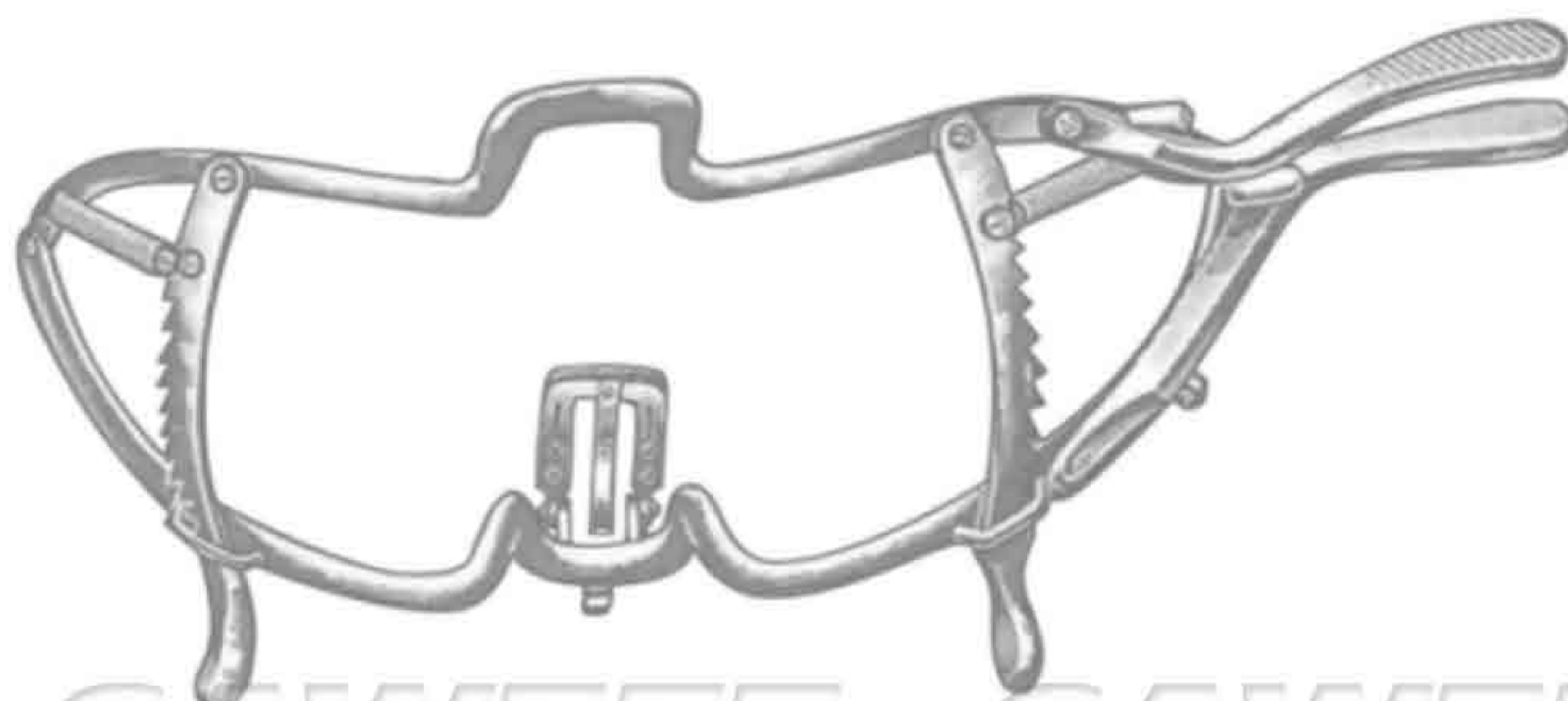


1/2

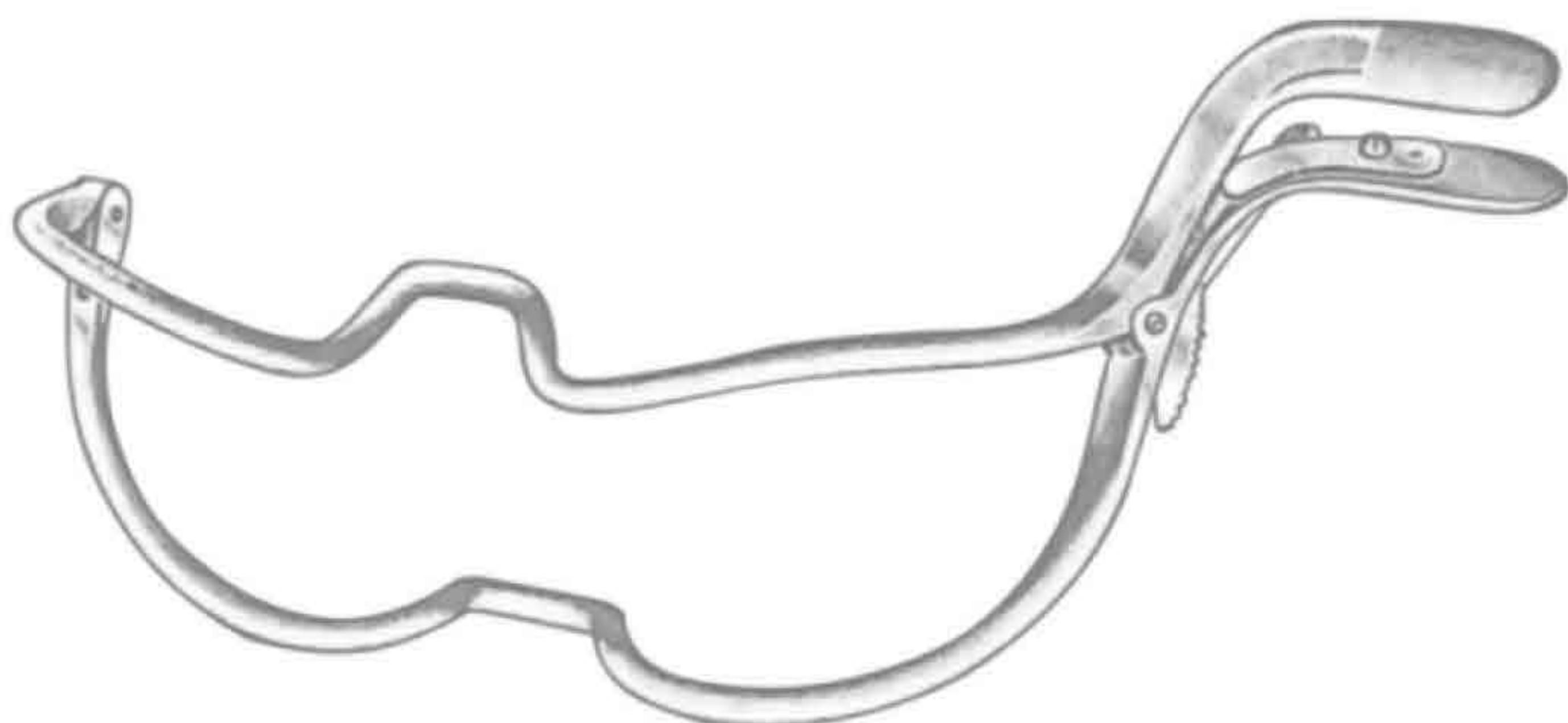
Roser-Konig
SSC-45-11-15 - 16.0 cm / 6 1/4"
SSC-45-11-16 - 19.0 cm / 7 1/2"



Whitehead
 SSC-45-11-17 - 11.0 cm / 4½"
 SSC-45-11-18 - 13.0 cm / 5"
 SSC-45-11-19 - 15.0 cm / 6"



Whitehead
 SSC-45-11-20 - 13.0 cm / 5"



Jennings
 SSC-45-11-21 - 9.0 cm / 3½"
 SSC-45-11-22 - 11.0 cm / 4½"
 SSC-45-11-23 - 13.0 cm / 5"
 SSC-45-11-24 - 15.0 cm / 6"



**Seemann-Seiffert
 (Self-retaining)**
 SSC-45-11-25 - 9.0 cm / 3½"
 SSC-45-11-26 - 11.0 cm / 4½"
 SSC-45-11-27 - 13.0 cm / 5"
 SSC-45-11-28 - 15.0 cm / 6"

Tongue Depressors



Kilner-Doughty
 complete with frame
 SSC-45-11-29



SSC-45-11-30
 Fig. 1



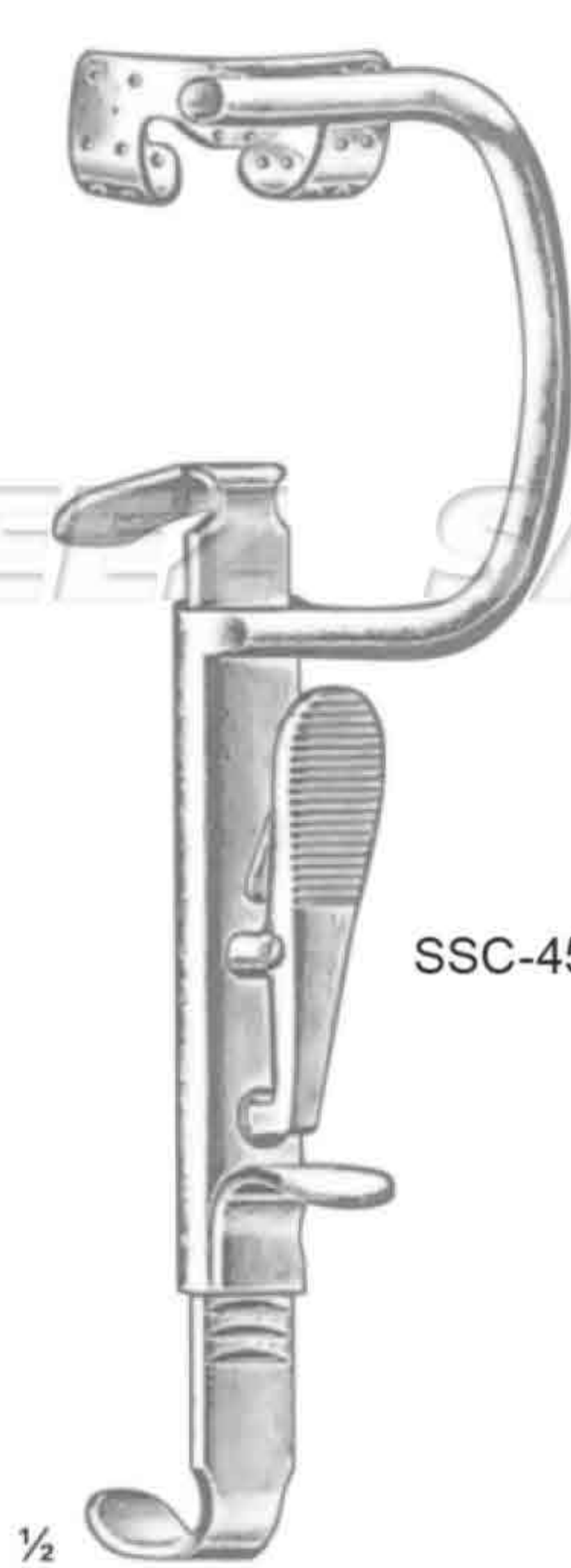
SSC-45-11-31
 Fig. 2



SSC-45-11-32
 Fig. 3



SSC-45-11-33



Davis-Boyle
SSC-45-11-34
complete with 5 blades



27 x 105mm SSC-45-11-36



25 x 90mm SSC-45-11-37



25 x 75mm SSC-45-11-38



22 x 60mm SSC-45-11-39



20 x 25mm SSC-45-11-40



Mcivor
SSC-45-11-41
complete with 3 blades



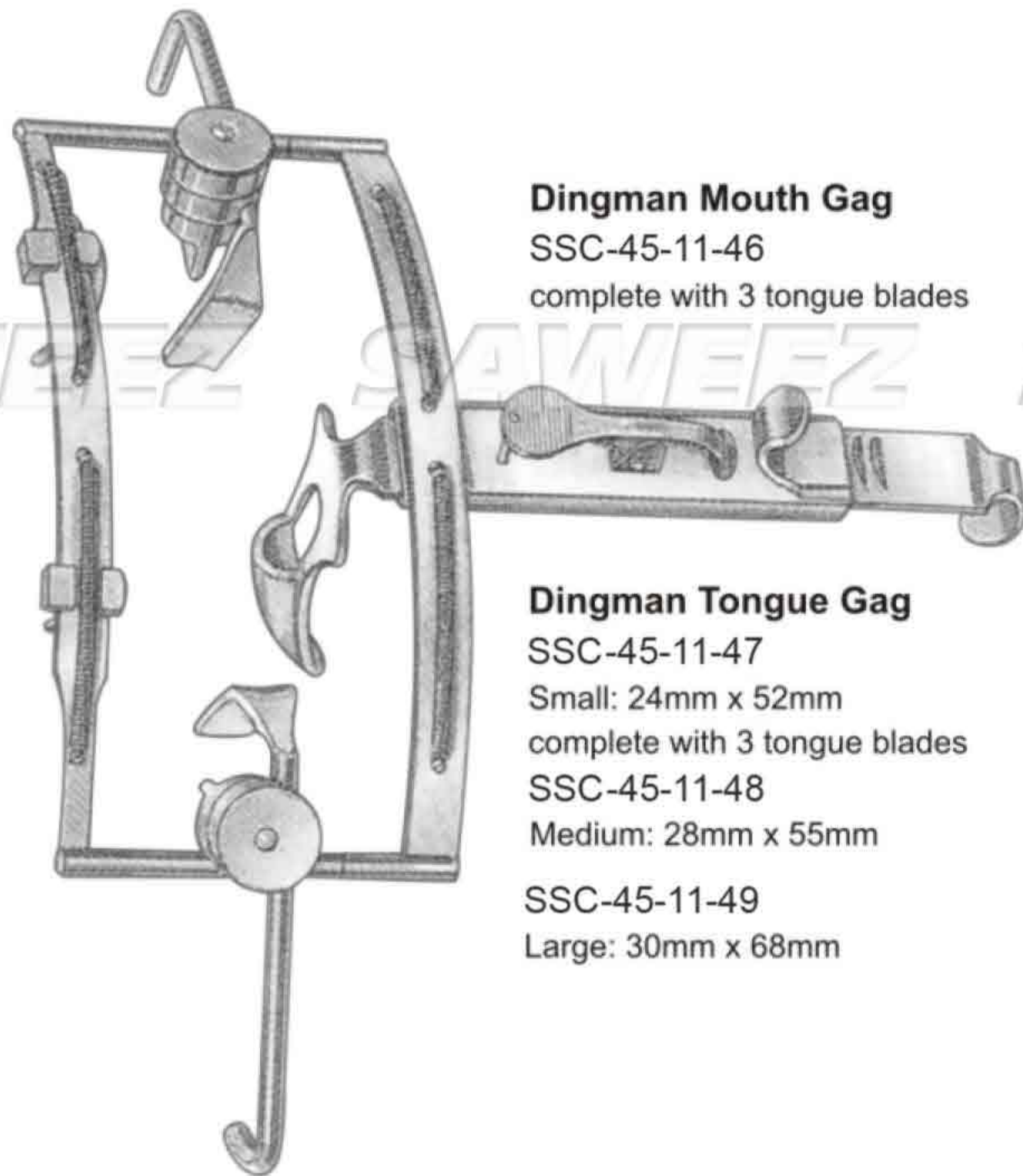
27 x 95 mm SSC-45-11-43



22 x 85 mm SSC-45-11-44



22 x 70 mm SSC-45-11-45



Dingman Mouth Gag
SSC-45-11-46
complete with 3 tongue blades

Dingman Tongue Gag
SSC-45-11-47
Small: 24mm x 52mm
complete with 3 tongue blades
SSC-45-11-48
Medium: 28mm x 55mm
SSC-45-11-49
Large: 30mm x 68mm

SAWEEZ SAWEEZ SAWEEZ SAWEEZ



Collin
SSC-45-11-50
17.0 cm / 6 3/4"



Guy
SSC-45-11-51
19.0 cm / 7 1/2"



Young
SSC-45-11-52
17.0 cm / 6 3/4"



1/4
SSC-45-11-53
pair

SAWEEZ SAWEEZ SAWEEZ SAWEEZ



1/2

Moritz-Schmidt
SSC-45-11-54
19.0 cm / 7 1/2"



1/2

Hartmann
SSC-45-11-55
15.0 cm / 6"



1/2

Tobold
SSC-45-11-56
14.0 cm / 5 1/2"



1/2

Tobold
SSC-45-11-57
14.0 cm / 5 1/2"



1/2

Andrew
SSC-45-11-58
11.0 cm / 4 1/2"



1/2

Wieder



1/2

SSC-45-11-59
14.0 cm / 5 1/2"



SSC-45-11-60
15.0 cm / 6"



SSC-45-11-61
16.0 cm / 6¼"
of wood

SSC-45-11-62
15.0 cm / 6"
of plastic

Haas
SSC-45-11-63
16.0 cm / 6¼"
of acrylic glass

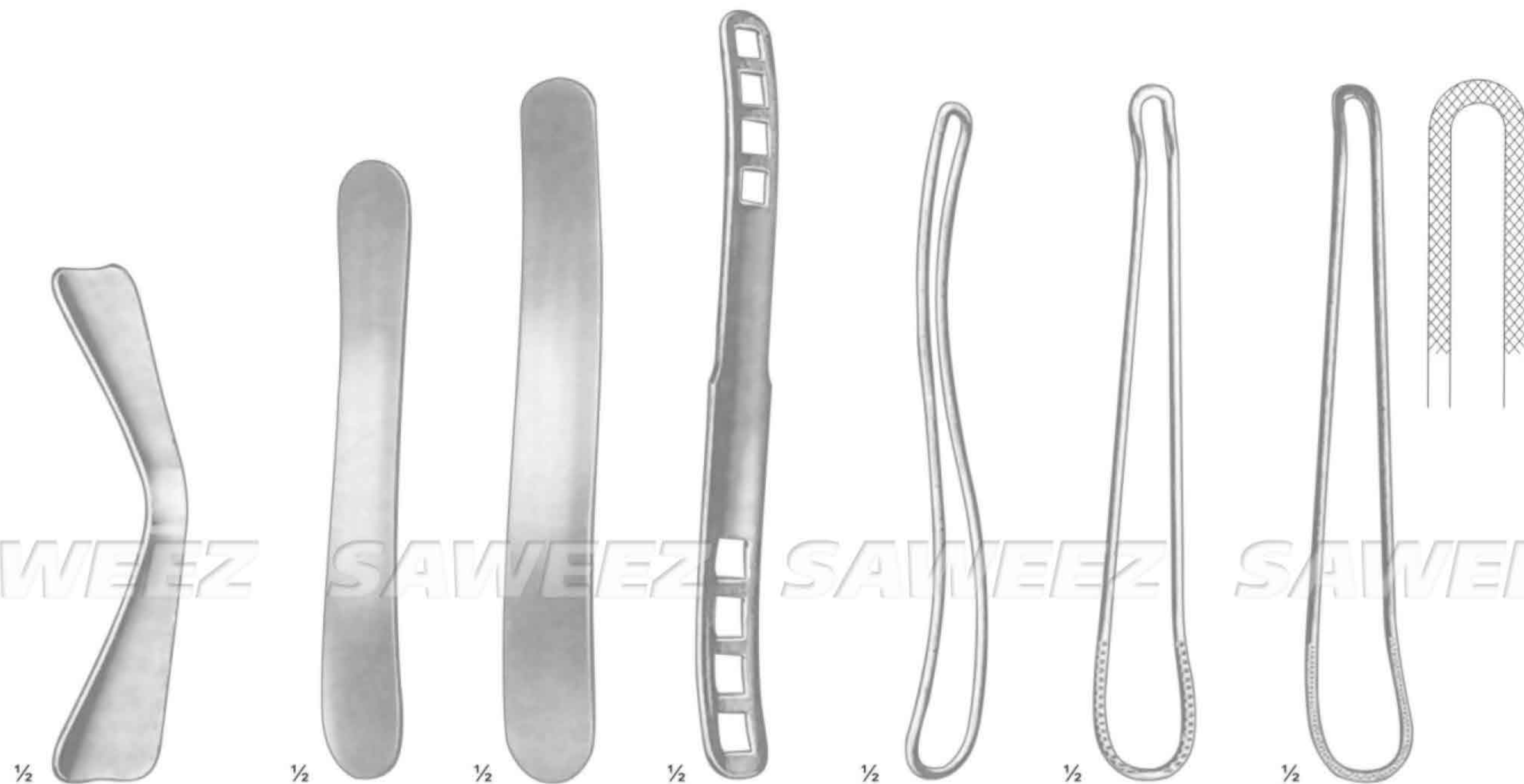
Buchwald
SSC-45-11-64
17.0 cm / 6¾"
of acrylic glass

Boilale
SSC-45-11-65
18.5 cm / 7¼"

SSC-45-11-66
14.5 cm / 5¾"

SSC-45-11-67
14.5 cm / 5¾"

can be autoclaved



Doyen
SSC-45-11-68- 13.0 cm / 5"
SSC-45-11-69- 16.0 cm / 6¼"

Kroenig
SSC-45-11-70
15.0 cm / 6"

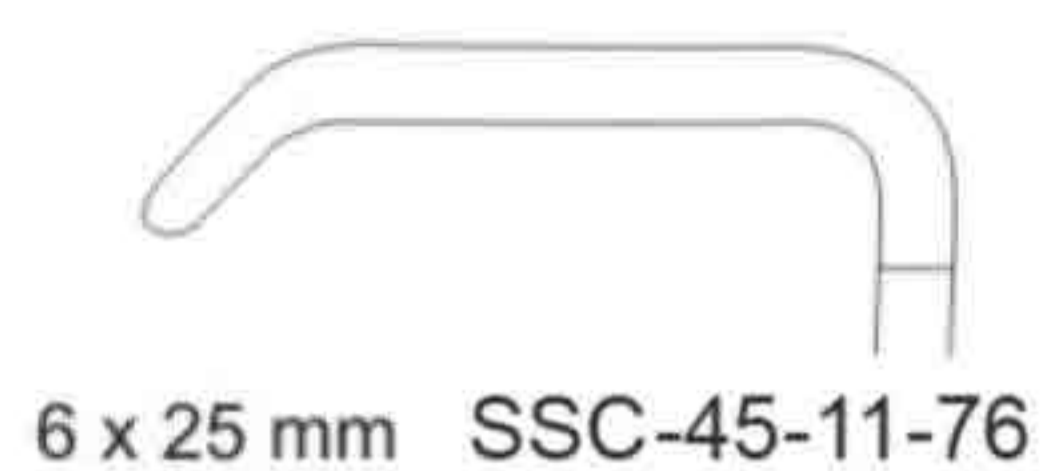
Mayo
SSC-45-11-71
17.0 cm / 6¾"

Bruenings
SSC-45-11-72
19.0 cm / 7½"

Collin
SSC-45-11-73
16.5 cm / 6½"

Special Model
SSC-45-11-74
16.5 cm / 6½"

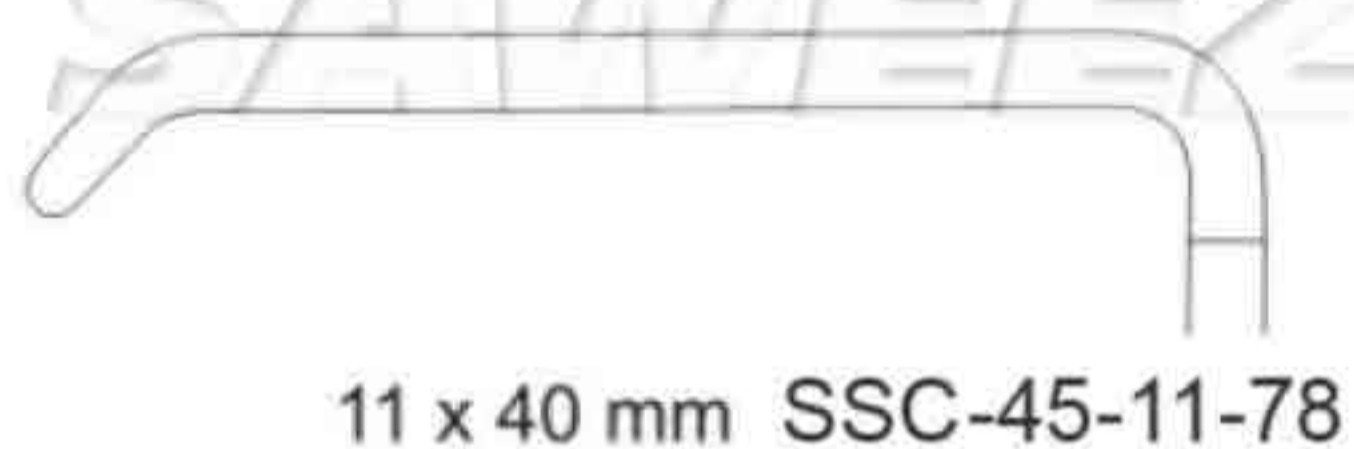
Frenzel
SSC-45-11-75
16.5 cm / 6½"



6 x 25 mm SSC-45-11-76



8 x 35 mm SSC-45-11-77



11 x 40 mm SSC-45-11-78



11 x 55 mm SSC-45-11-79



14 x 70 mm SSC-45-11-80



16 x 80 mm SSC-45-11-81



11 x 40 mm SSC-45-11-82



11 x 55 mm SSC-45-11-83



16 x 80 mm SSC-45-11-84



Obwegeser (Kocher-Langenbeck)
21.5 cm / 8½"

½



Obwegeser
22.0 cm / 8¾"

½



Obwegeser
SSC-45-11-85
16.0 cm / 6¼"

½



Obwegeser
SSC-45-11-86 - 8 mm
SSC-45-11-87 - 10 mm
16.0 cm / 6¼"

½

10 x 42 mm

11 x 70 mm



Obwegeser
SSC-45-11-88
22.0 cm / 8¾"

½



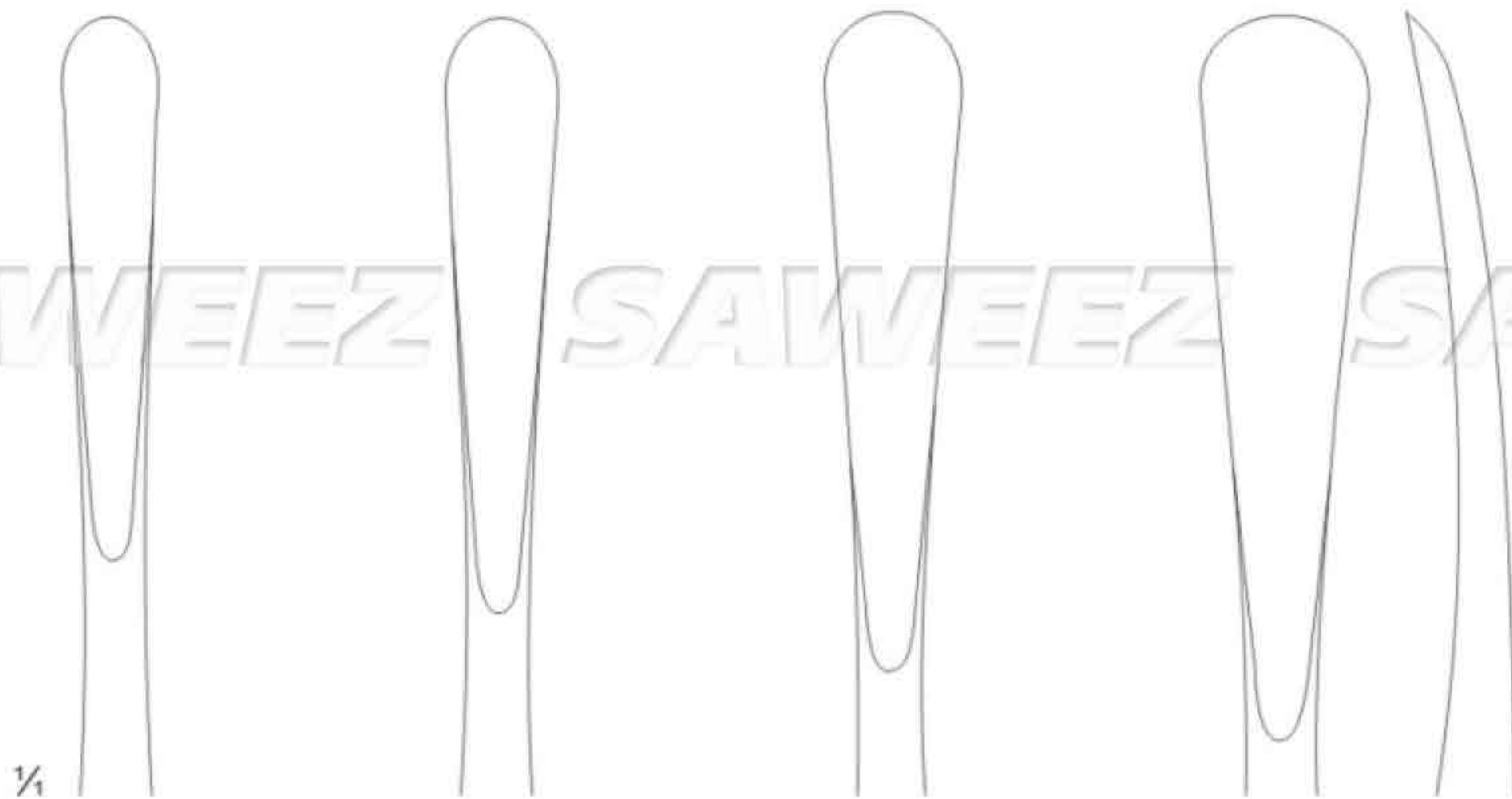
Obwegeser
SSC-45-11-89
22.0 cm / 8¾"

½



1/2

Obwegeser
17.5 cm / 7"



1/4

6 mm
SSC-45-11-90

7 mm
SSC-45-11-91

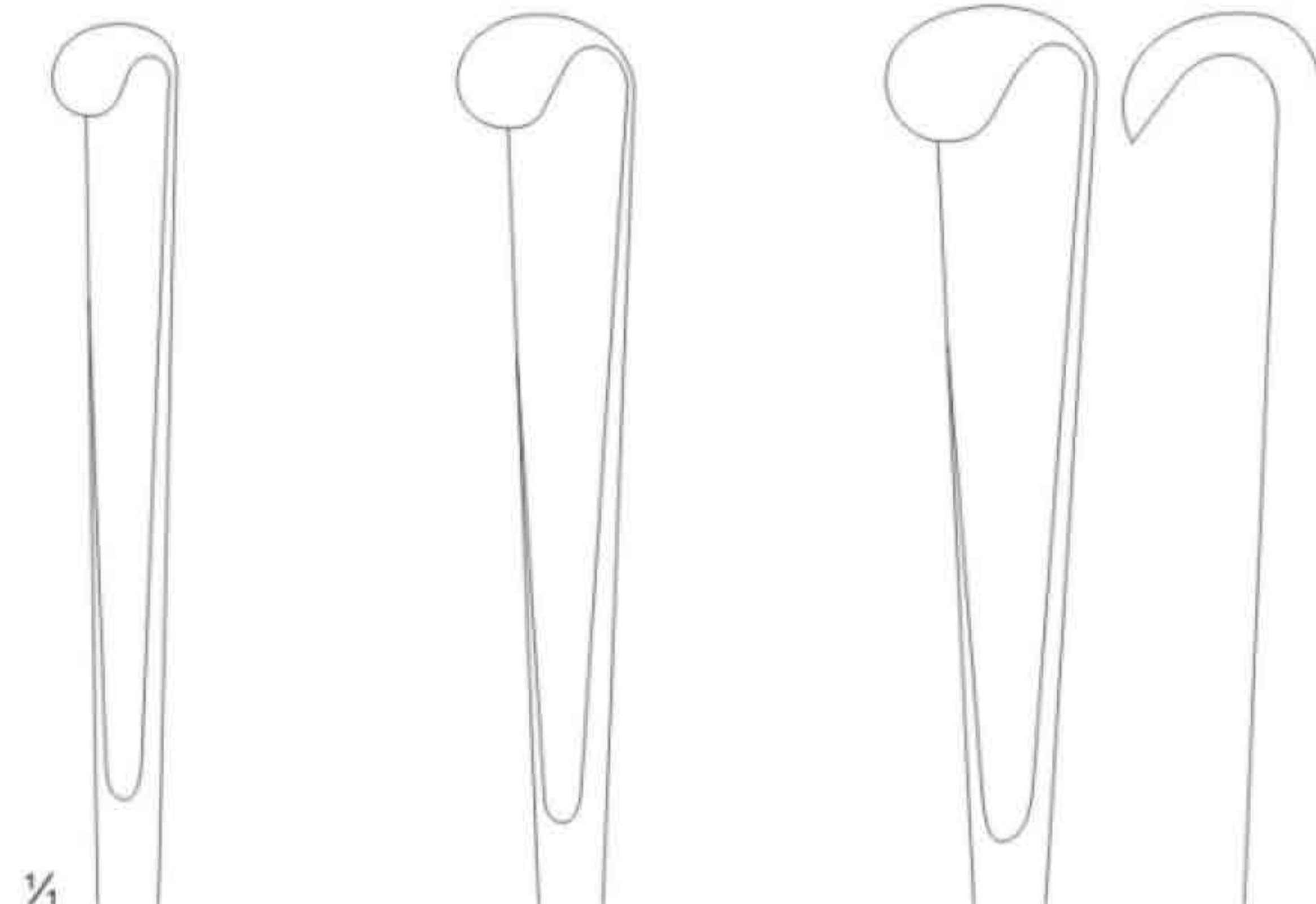
9 mm
SSC-45-11-92

11 mm
SSC-45-11-93



1/2

Obwegeser
20.0 cm / 8"

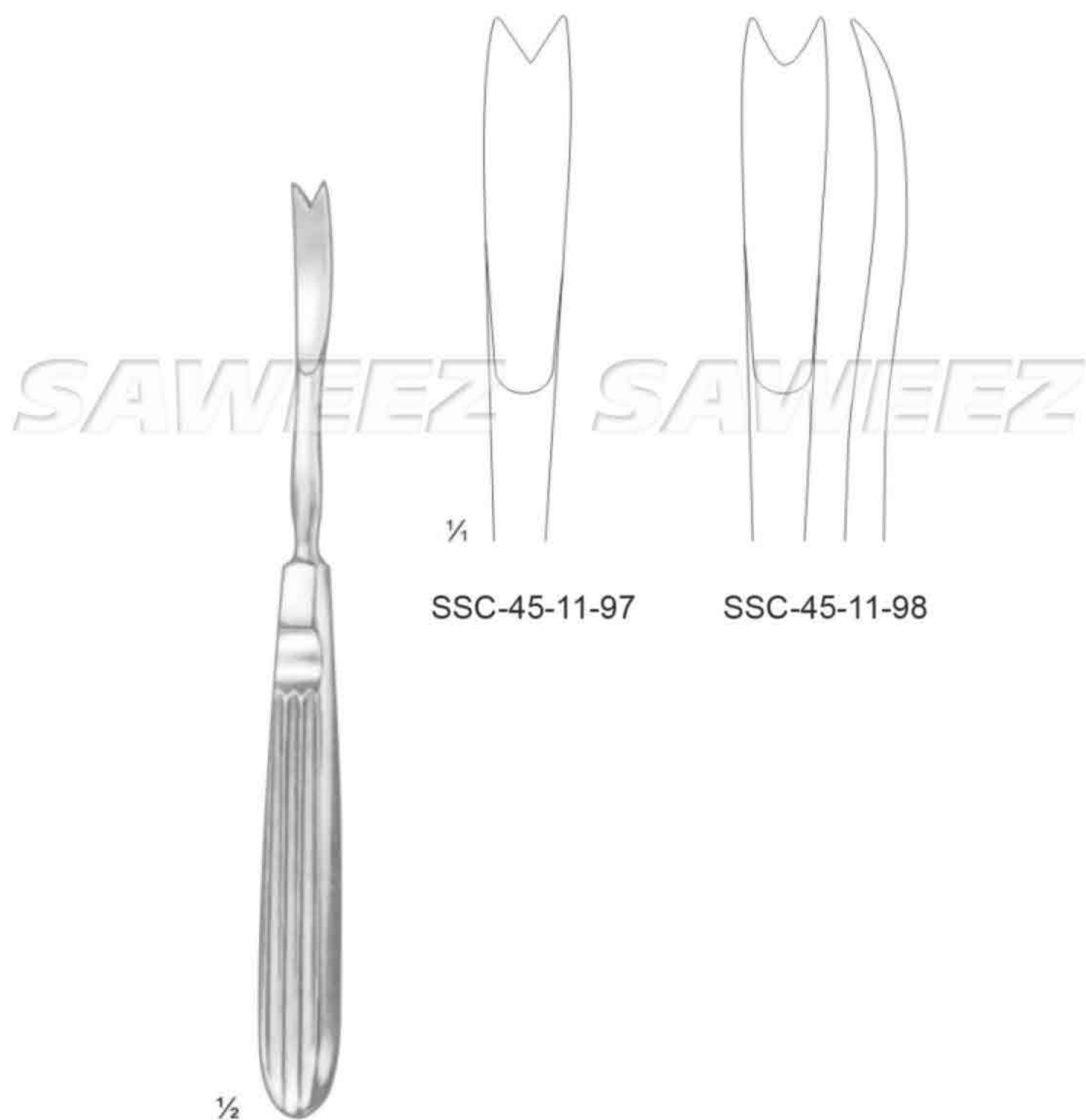


1/4

5 mm
SSC-45-11-94

7 mm
SSC-45-11-95

9 mm
SSC-45-11-96



SSC-45-11-97

SSC-45-11-98

1/2

Obwegeser
17.0 cm / 7"



SSC-45-11-99
21.0 cm / 8 1/4"

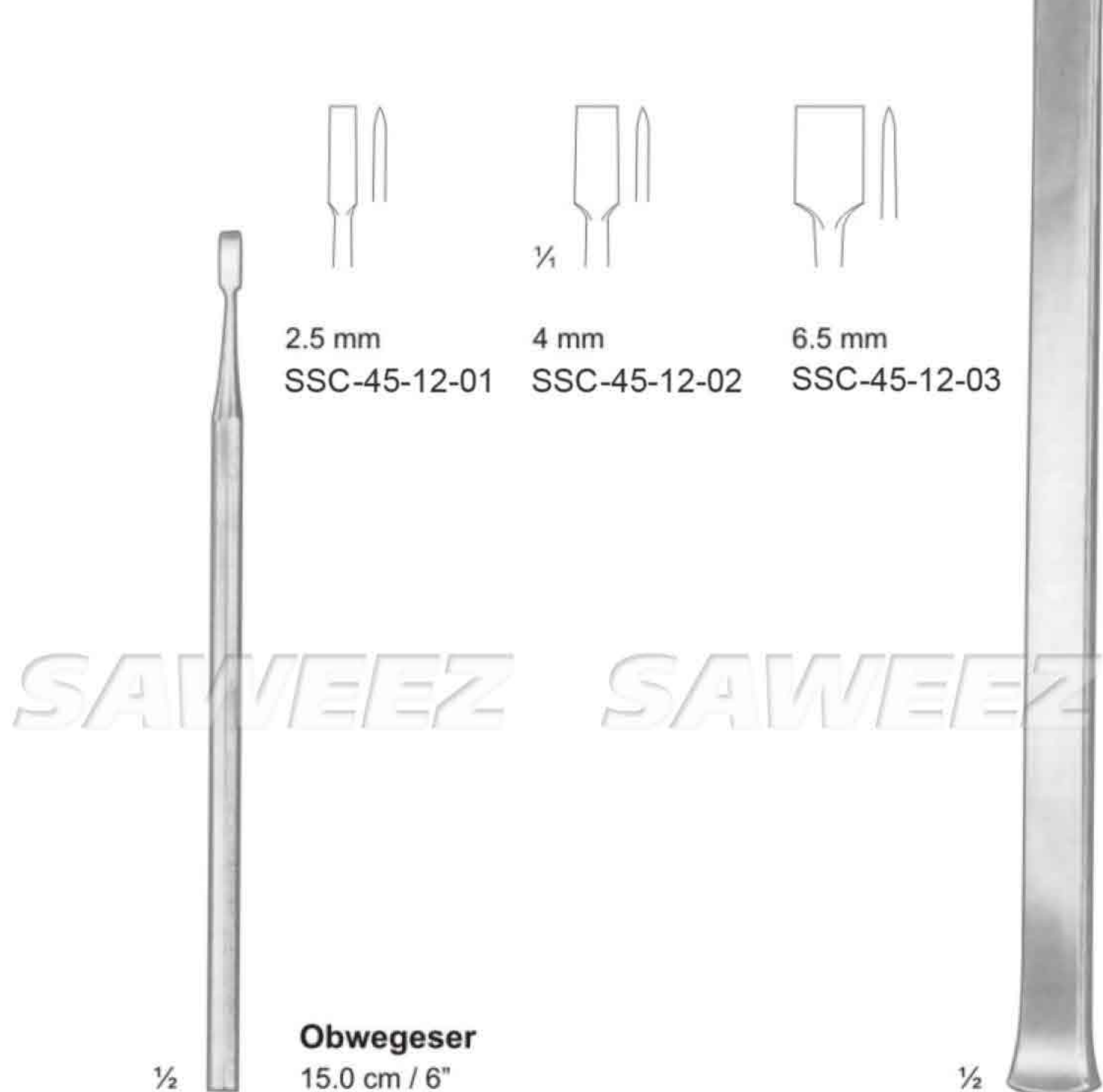
SSC-45-12-00
21.0 cm / 8 1/4"

1/2

Obwegeser

1/2

Obwegeser



2.5 mm

SSC-45-12-01

4 mm

SSC-45-12-02

6.5 mm

SSC-45-12-03

1/2

Obwegeser
15.0 cm / 6"

1/2

Obwegeser
23.5 cm / 9 3/4"



SSC-45-12-04

SSC-45-12-05

SSC-45-12-06

1/2

Obwegeser
18.5 cm / 7 1/4"





SAWEEZ SAWEEZ SAWEEZ SAWEEZ



SAWEEZ SAWEEZ SAWEEZ SAWEEZ

SAWEEZ SAWEEZ SAWEEZ SAWEEZ



1/2



1/2



1/2

Obwegeser

SSC-45-12-07 - 18.0 cm / 7"

SSC-45-12-08 - 28.0 cm / 11"

Obwegeser

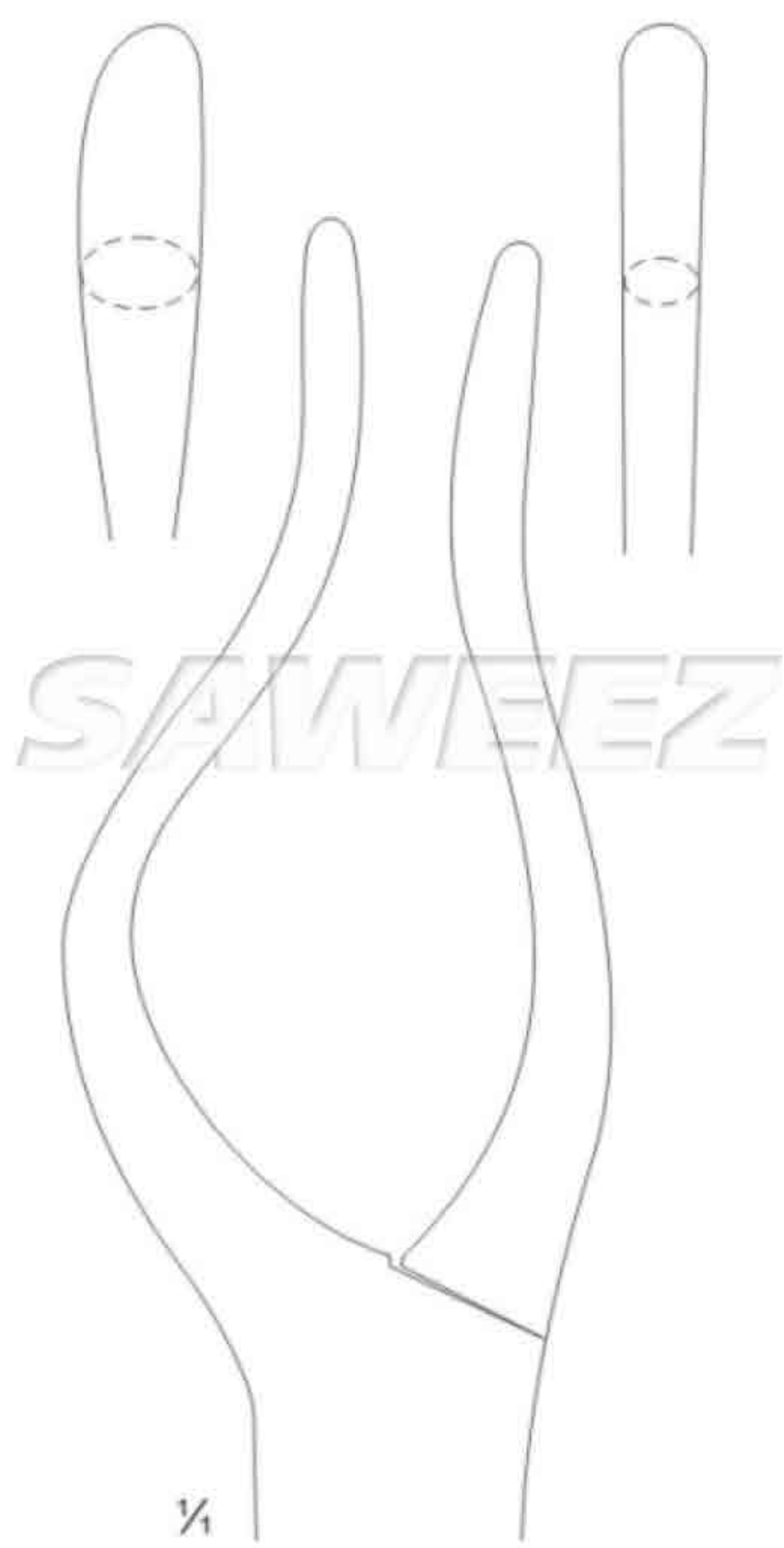
SSC-45-12-09

13.0 cm / 5"

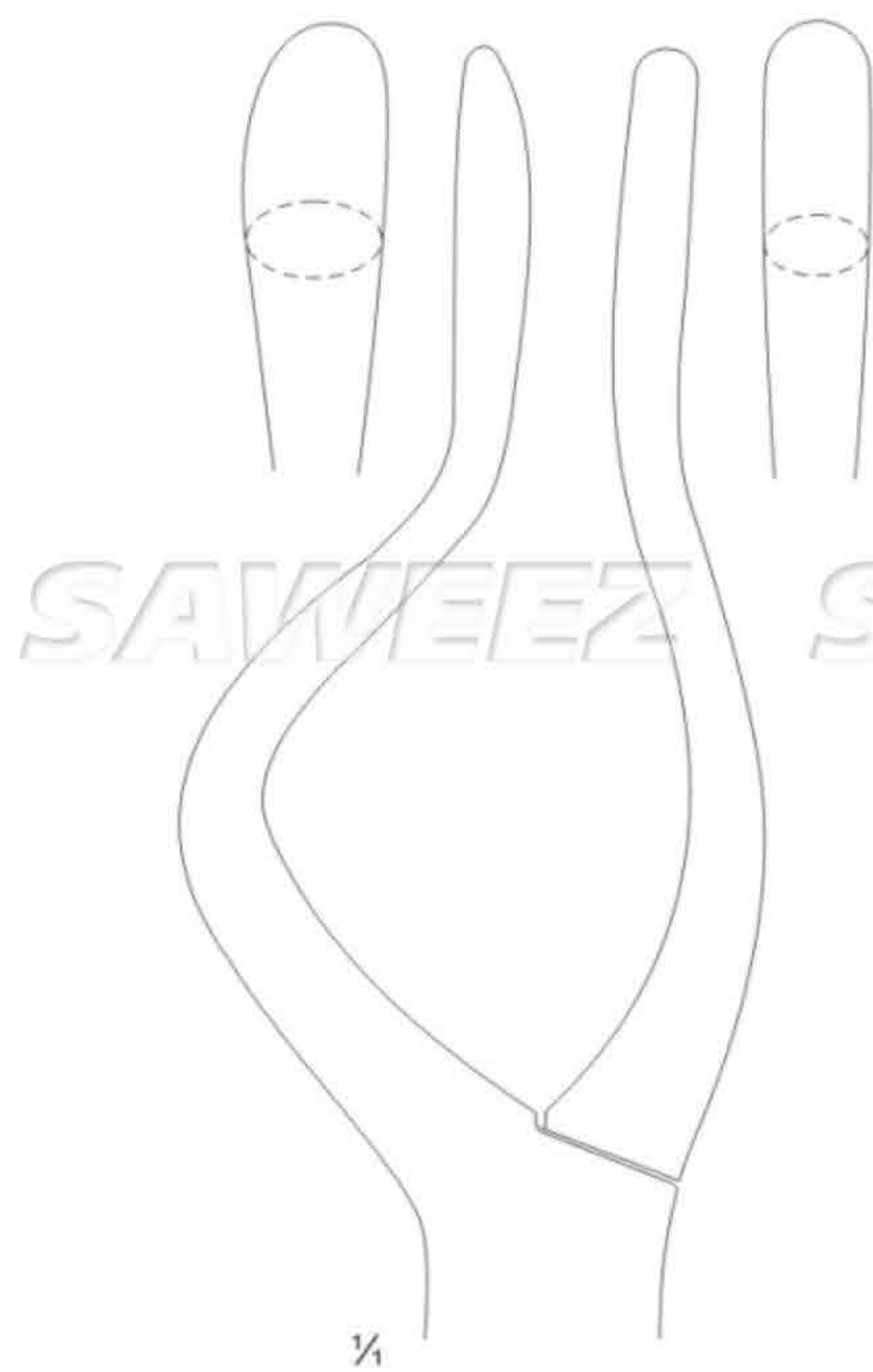
Obwegeser

SSC-45-12-10

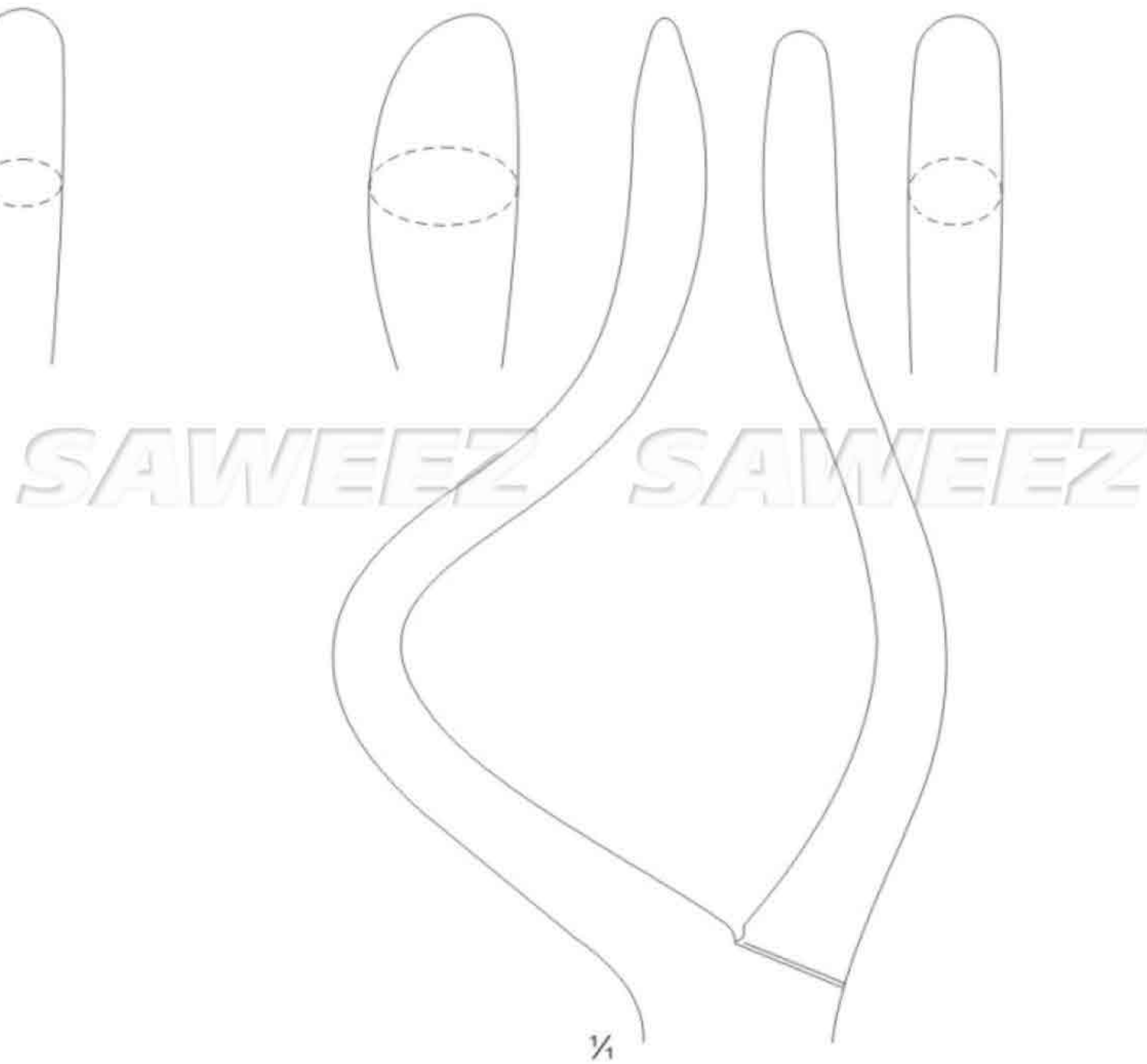
23.0 cm / 9"



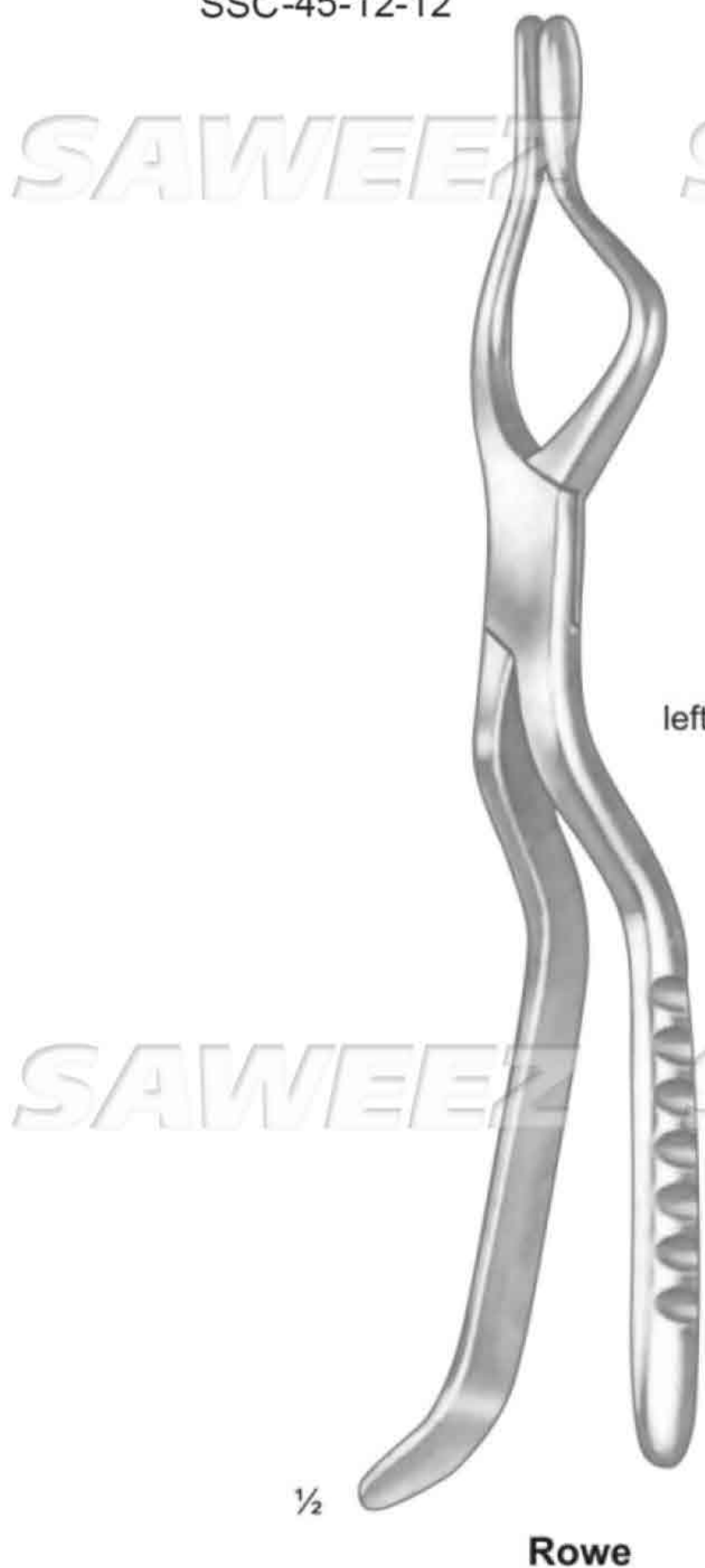
SSC-45-12-11
SSC-45-12-12



SSC-45-12-13
SSC-45-12-14



SSC-45-12-15
SSC-45-12-16



Rowe



Rowe



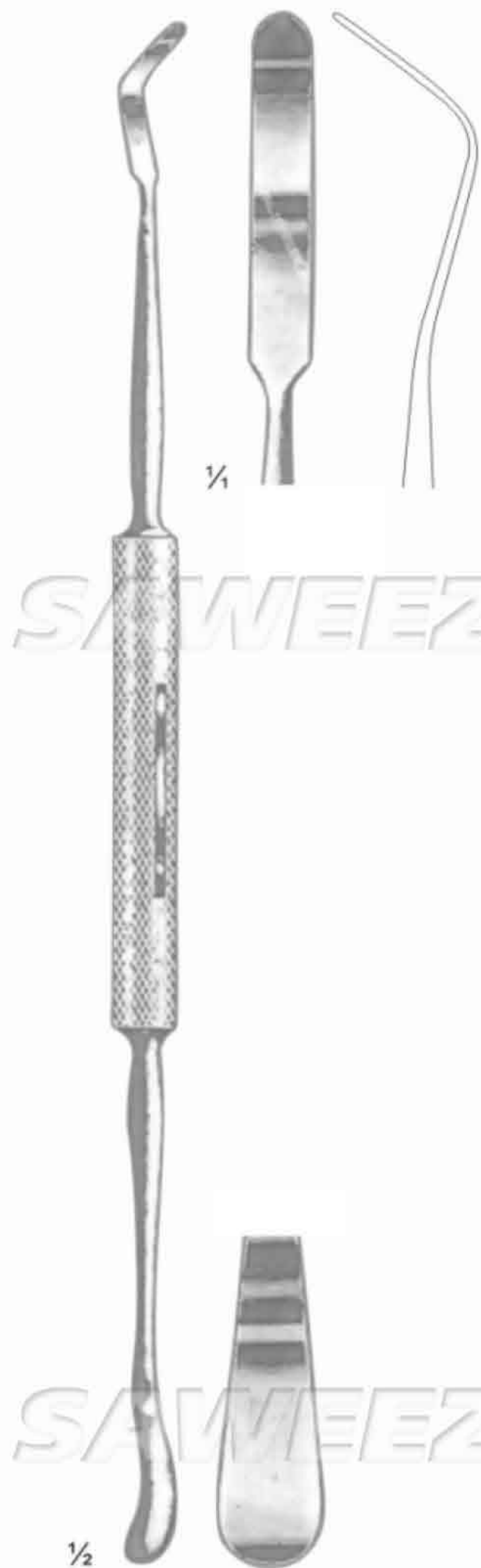
Fisher
SSC-47-11-11
23.0 cm / 9"

Abraham
SSC-47-11-12
21.0 cm / 8¼"

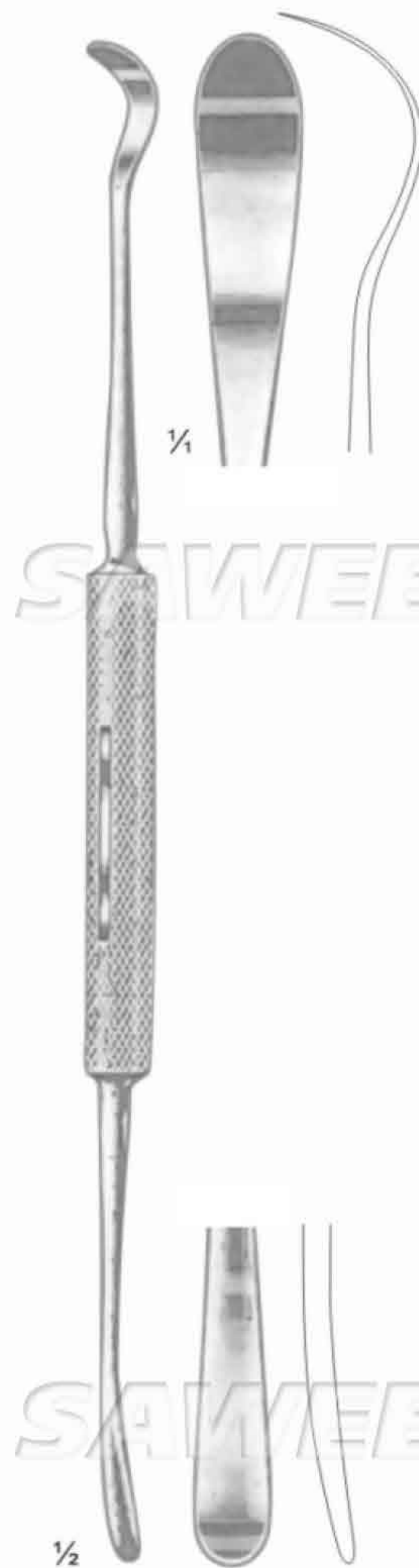
Bruenings
SSC-47-11-13
23.0 cm / 9"



SAWEEZ SAWEEZ SAWEEZ SAWEEZ



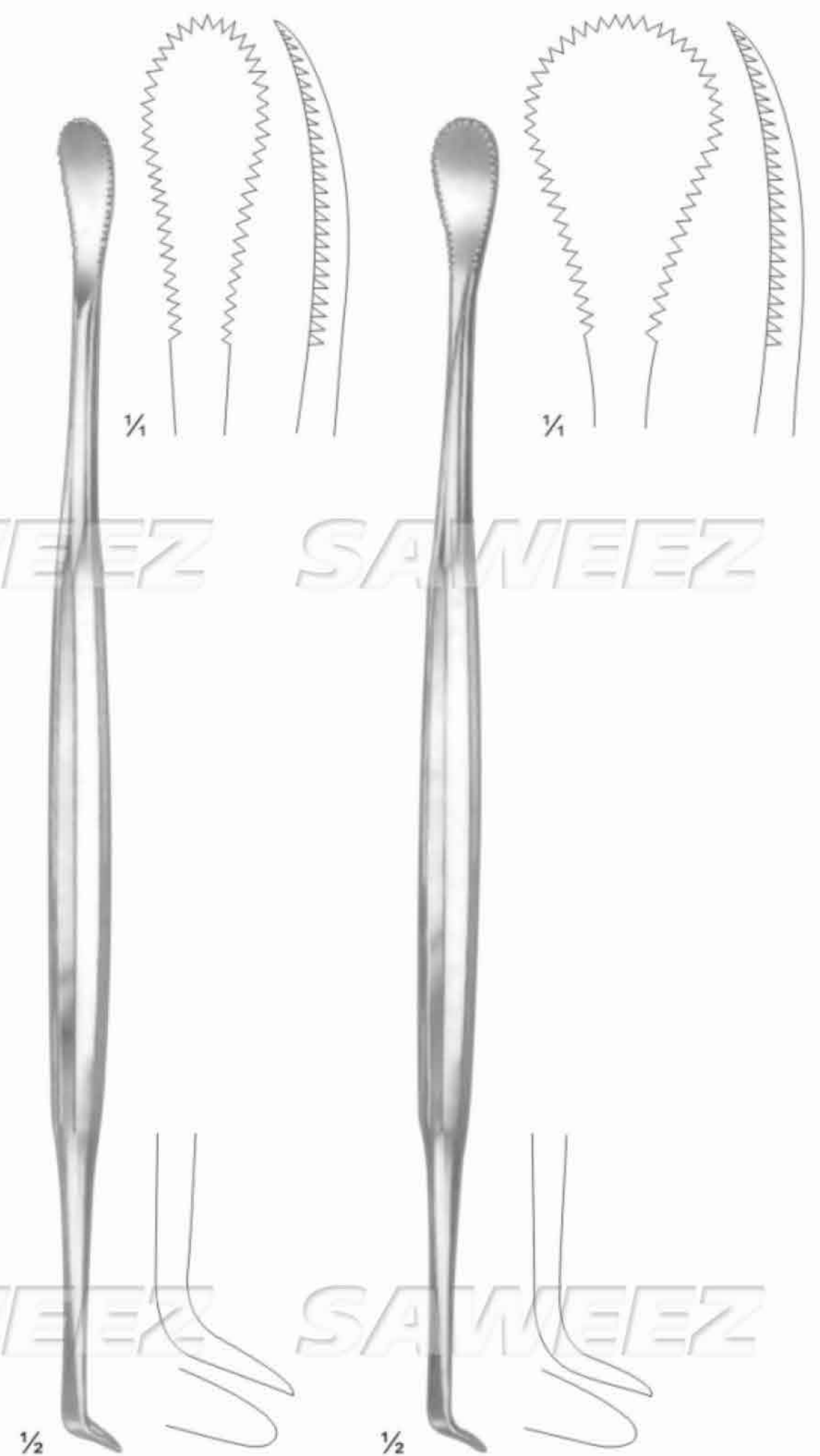
Carpenter
SSC-47-11-14
25.0 cm / 10"



Carpenter
SSC-47-11-15
24.0 cm / 9½"



Hurd
SSC-47-11-16
23.0 cm / 9"

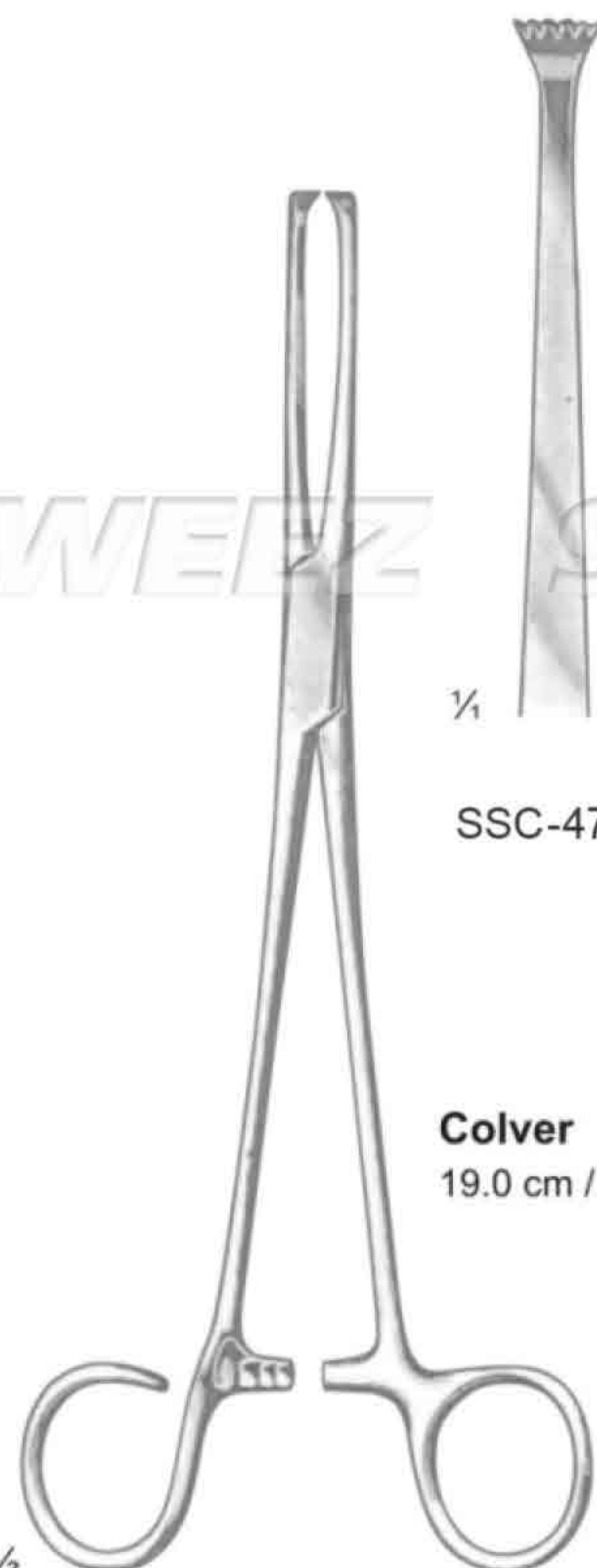


Henke
SSC-47-11-17
23.0 cm / 9"



Henke
SSC-47-11-18
23.0 cm / 9"

SAWEEZ SAWEEZ SAWEEZ SAWEEZ

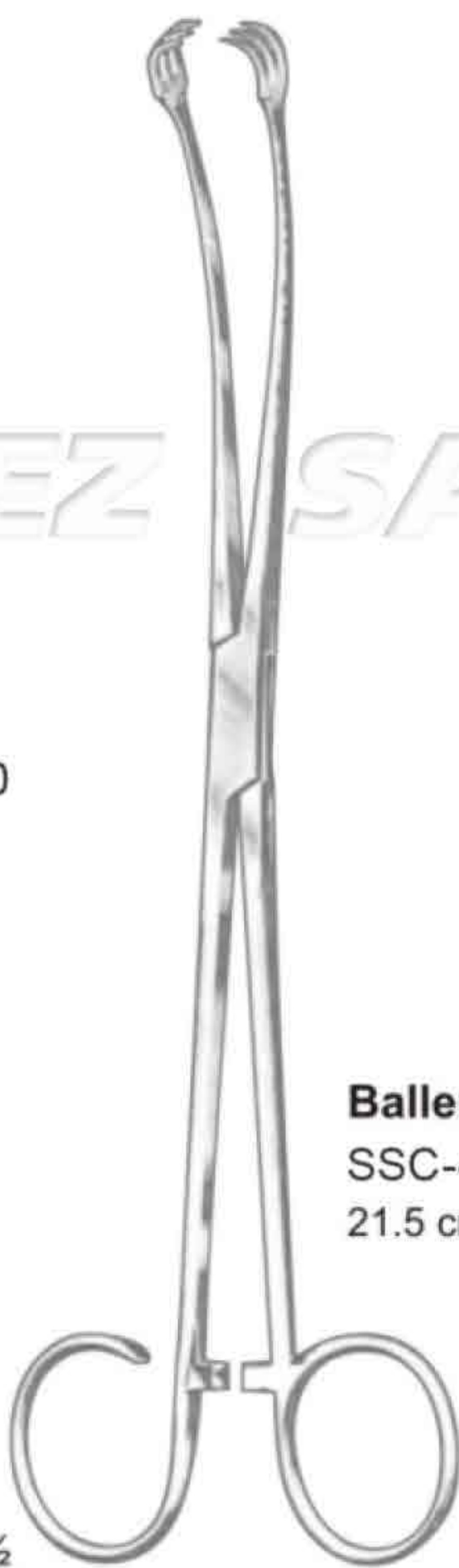


Colver
19.0 cm / 7½"

½



¼
SSC-47-11-19 SSC-47-11-20



Ballenger
SSC-47-11-21
21.5 cm / 8½"

½



White
SSC-47-11-22 - 18.0 cm / 7"
SSC-47-11-23 - 23.0 cm / 9"

½



Blohmke
20.0 cm / 8"

½

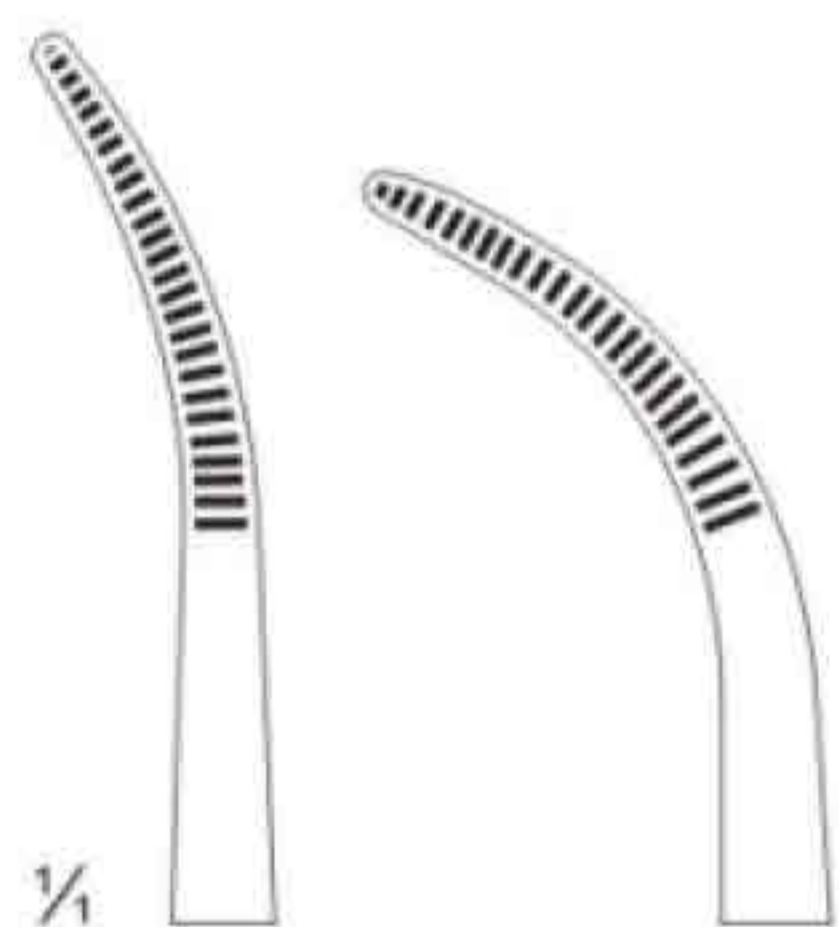


¼
SSC-47-11-24



Schnidt
19.0 cm / 7½"

½



¼
SSC-47-11-25 SSC-47-11-26

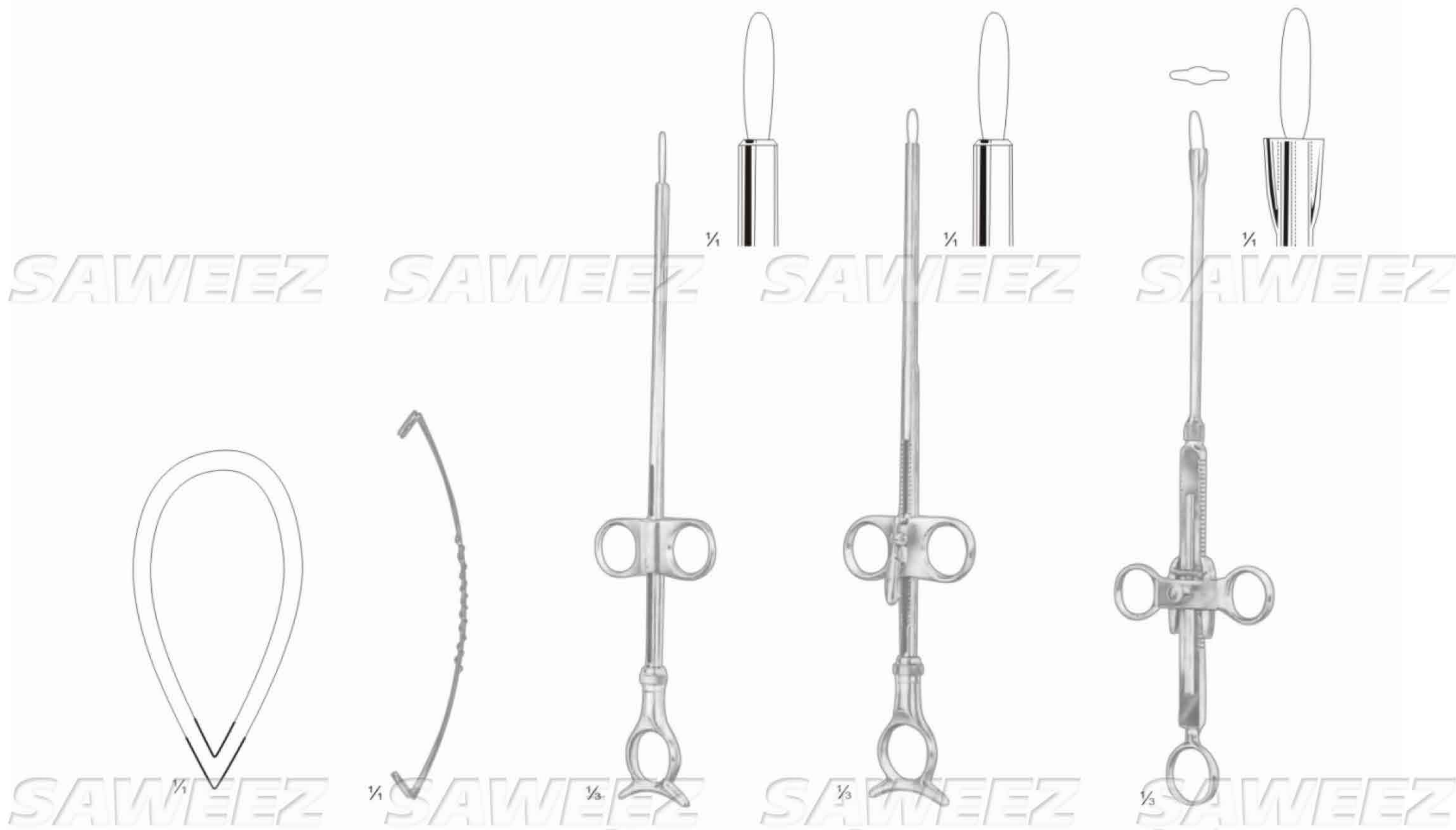


Schnidt
19.0 cm / 7½"

½



¼
SSC-47-11-27 SSC-47-11-28



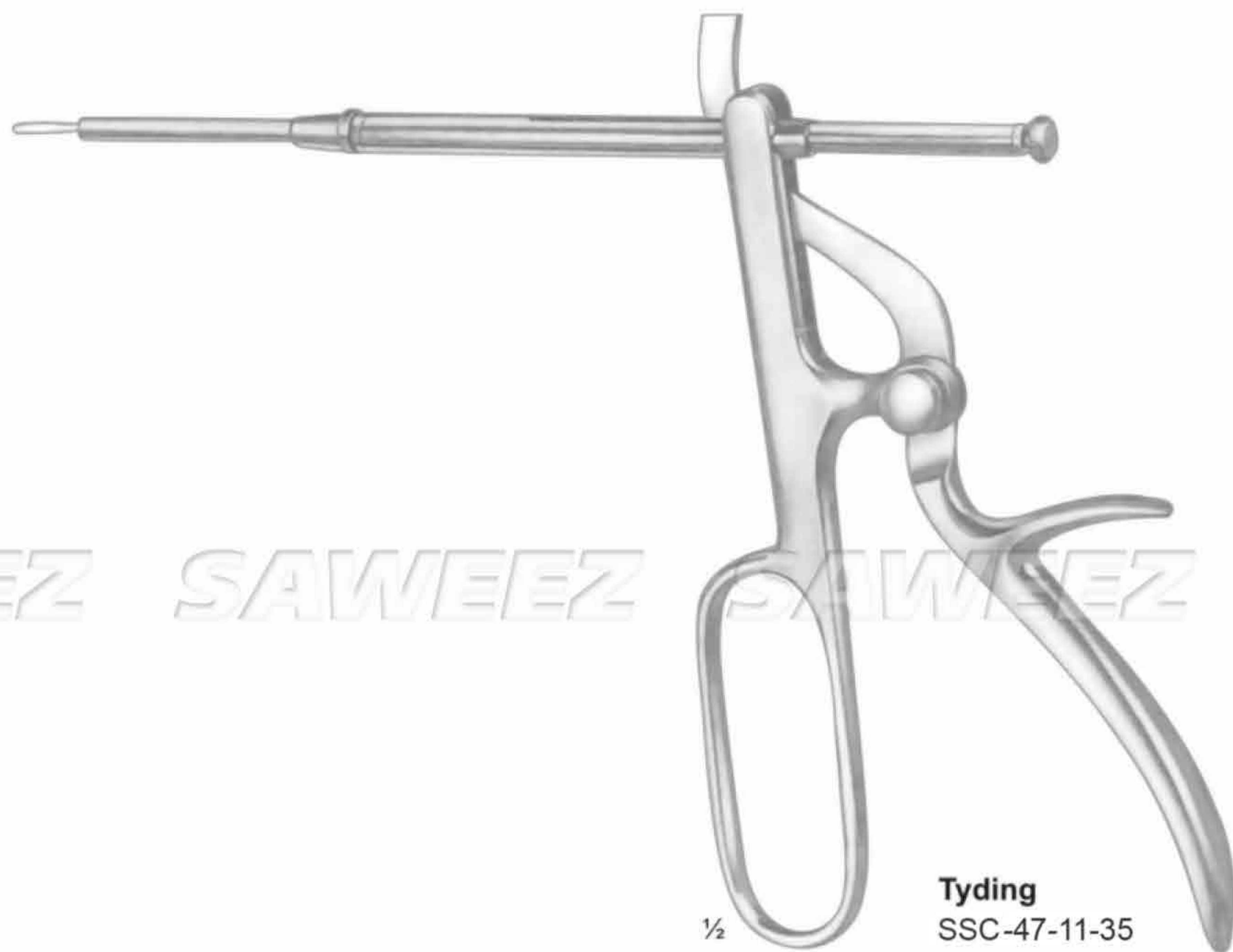
SSC-47-11-29 - 40 mm
SSC-47-11-30 - 50 mm

SSC-47-11-31
0.3 mm ø

Eves
SSC-47-11-32
28.0 cm / 11"

Eves
SSC-47-11-33
28.0 cm / 11"

Bruenings
SSC-47-11-34
28.0 cm / 11"



Tyding
SSC-47-11-35
with 1 straight tip

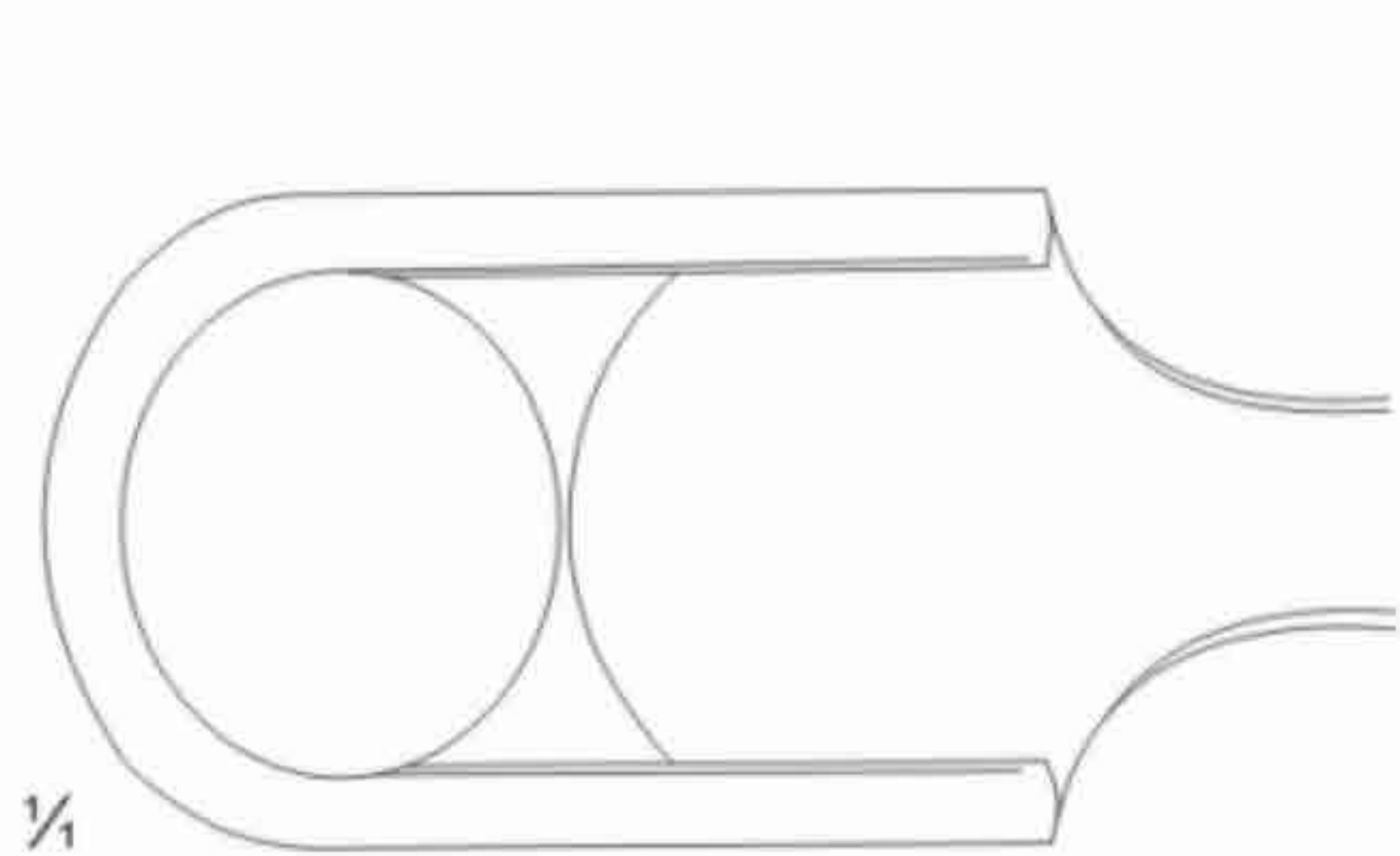


Fig. 1

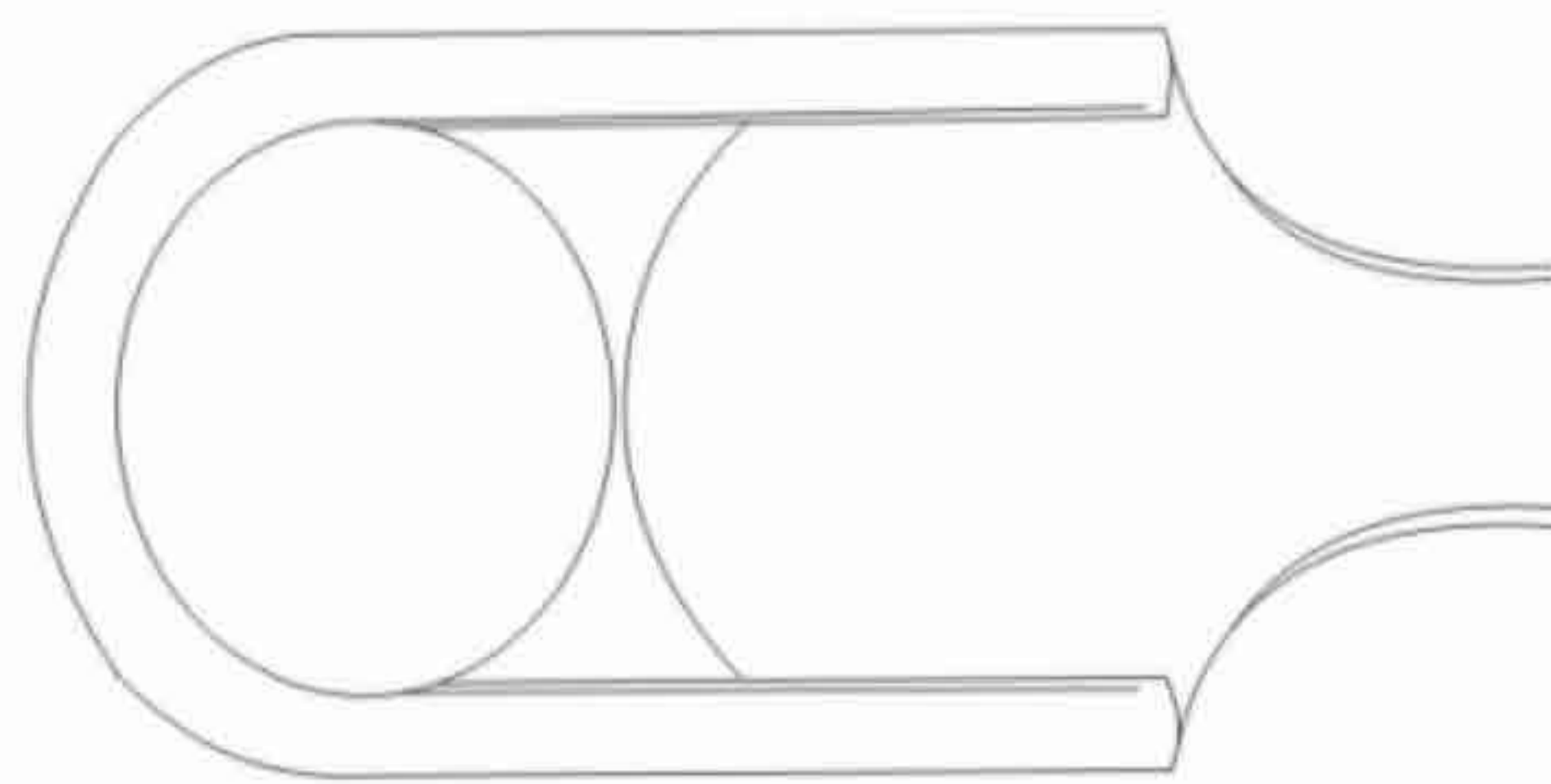


Fig. 2

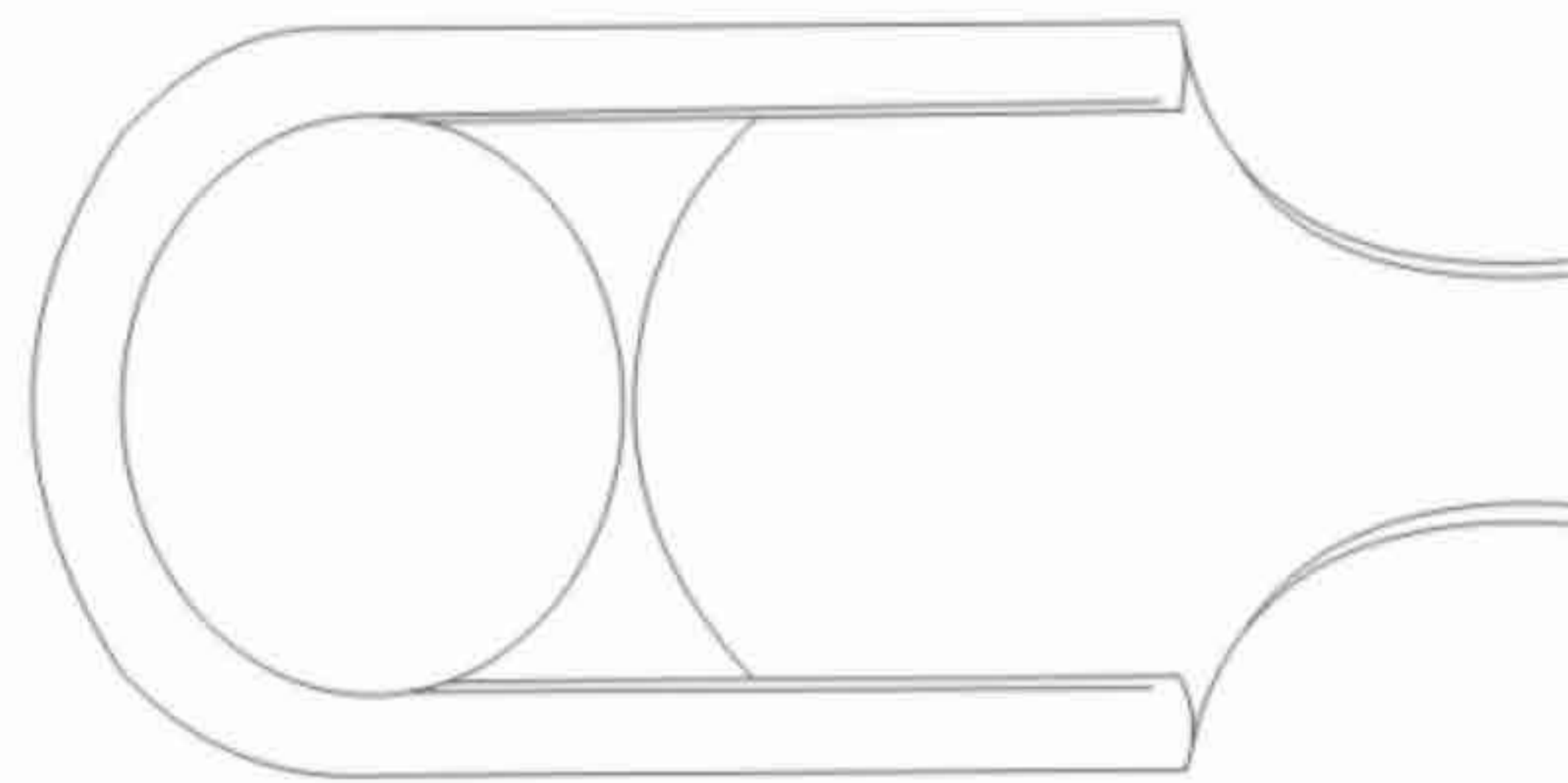
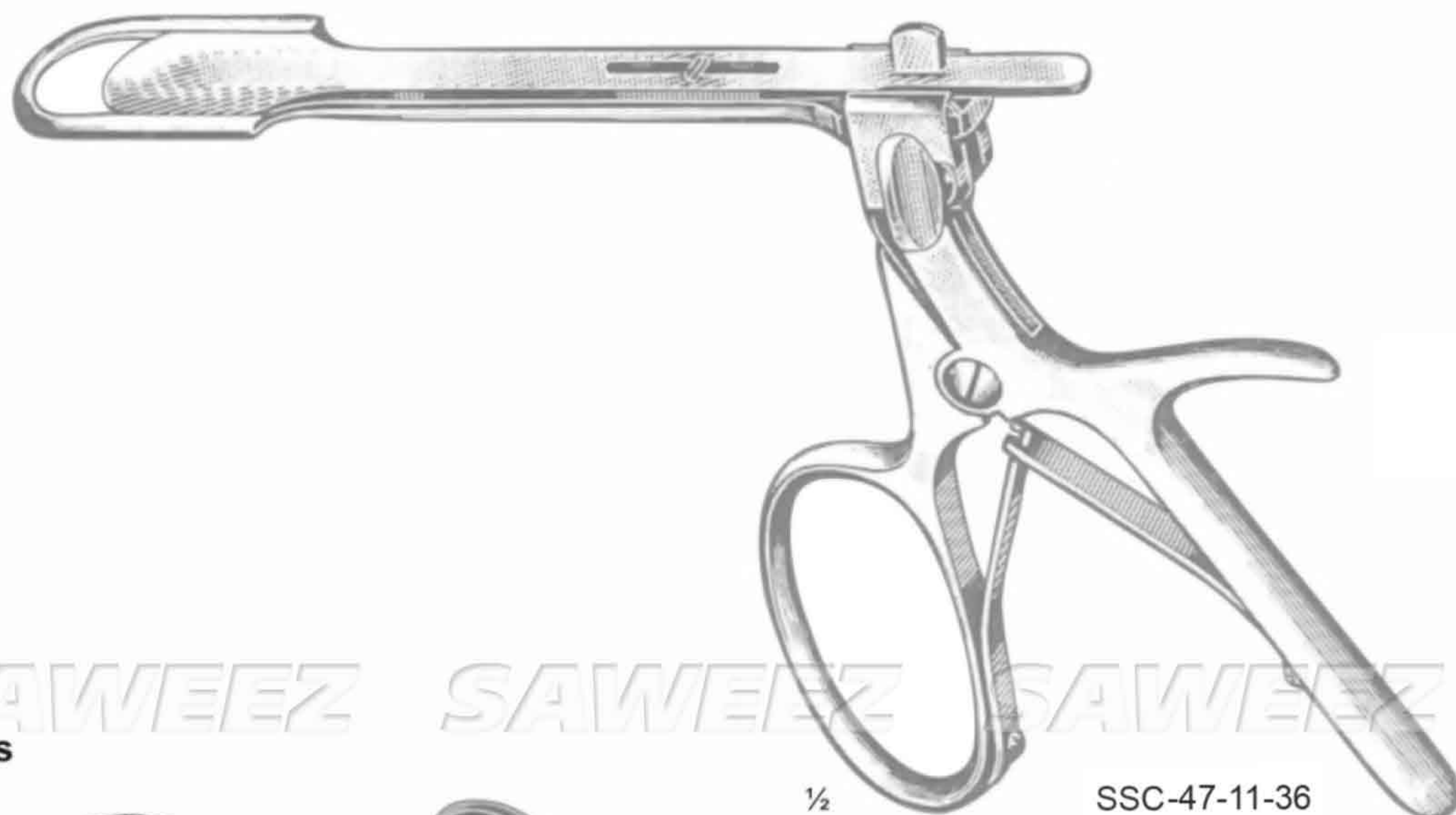


Fig. 3



1/2

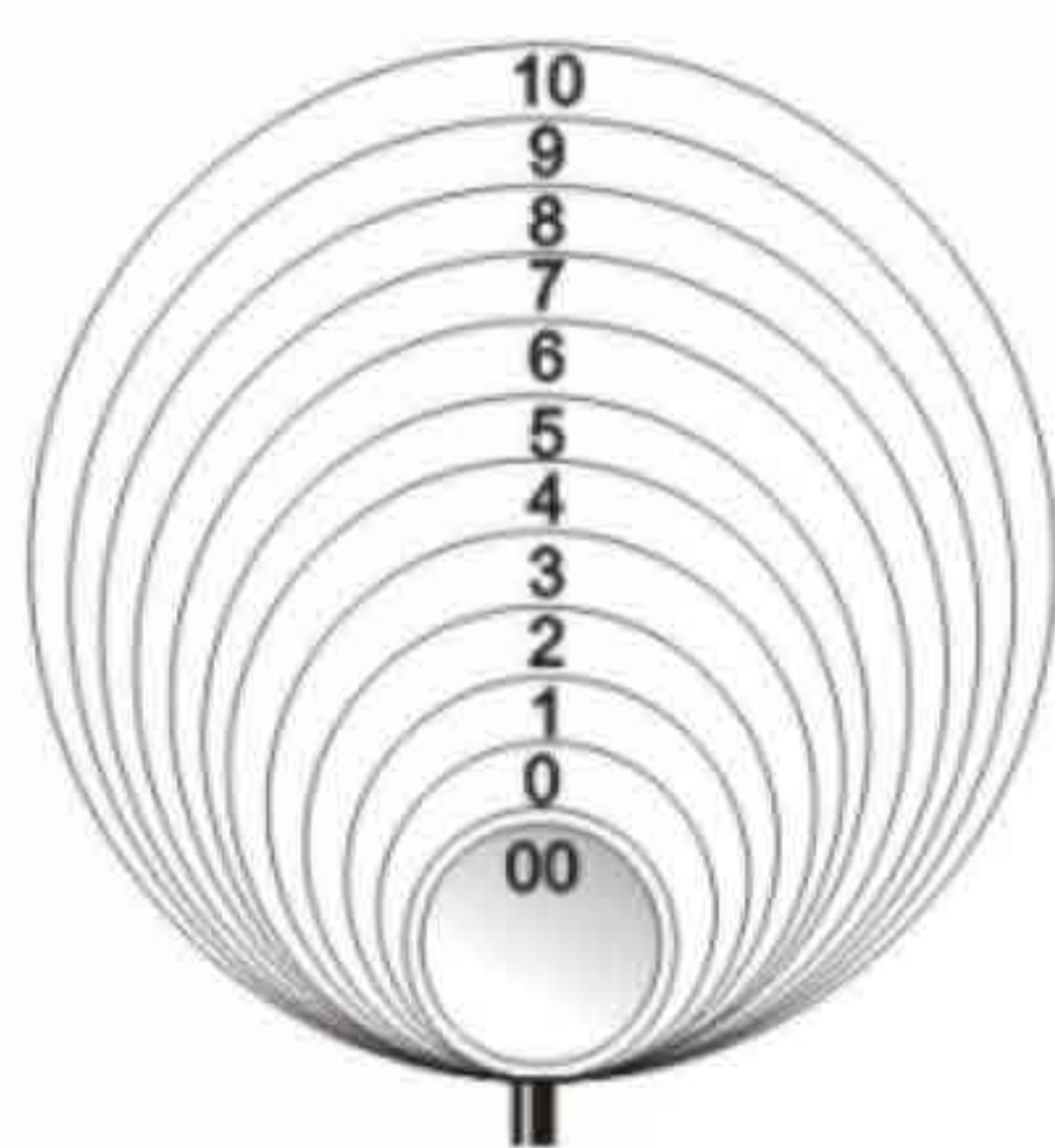
SSC-47-11-36

complete with 3 tip

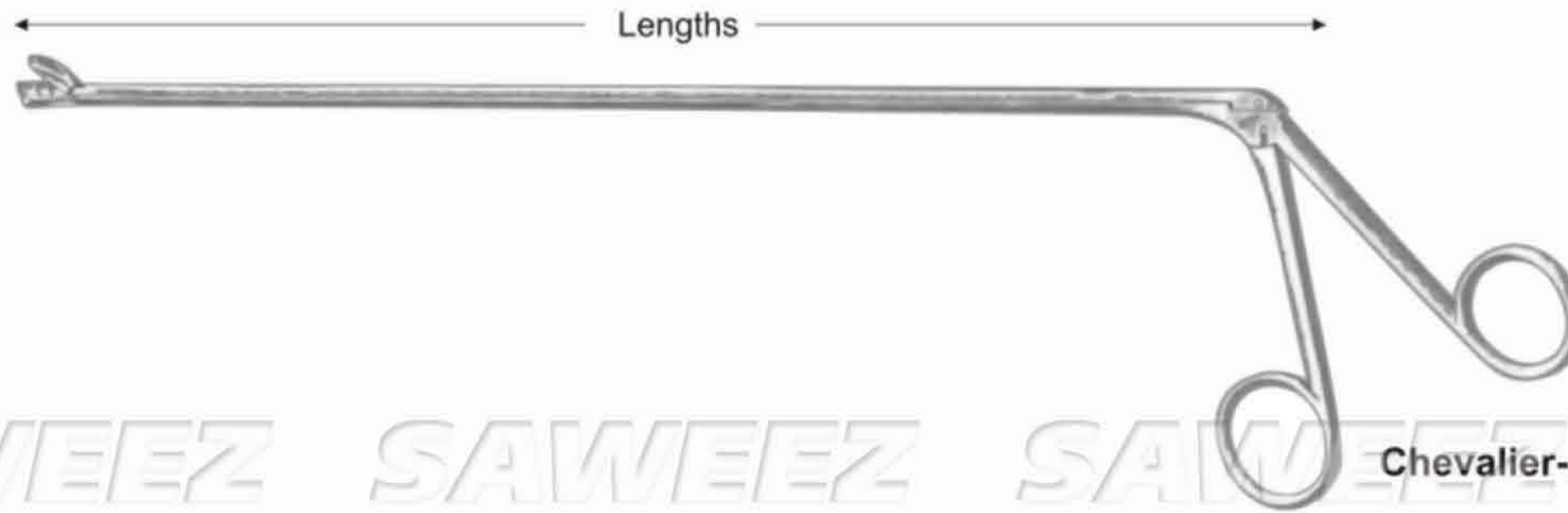


1/2

Laryngeal Mirrors



SSC-47-11-37 Fig.00	=	8 mm ø	SML-47-11-49
SSC-47-11-38 Fig.0	=	10 mm ø	SML-47-11-50
SSC-47-11-39 Fig.1	=	12 mm ø	SML-47-11-51
SSC-47-11-40 Fig.2	=	14 mm ø	SML-47-11-52
SSC-47-11-41 Fig.3	=	16 mm ø	SML-47-11-53
SSC-47-11-42 Fig.4	=	18 mm ø	SML-47-11-54
SSC-47-11-43 Fig.5	=	20 mm ø	SML-47-11-55
SSC-47-11-44 Fig.6	=	22 mm ø	SML-47-11-56
SSC-47-11-45 Fig.7	=	24 mm ø	SML-47-11-57
SSC-47-11-46 Fig.8	=	26 mm ø	SML-47-11-58
SSC-47-11-47 Fig.9	=	28 mm ø	SML-47-11-59
SSC-47-11-48 Fig.10	=	30 mm ø	SML-47-11-60



SAWEEZ SAWEEZ SAWEEZ SAWEEZ

Chevalier-Jackson

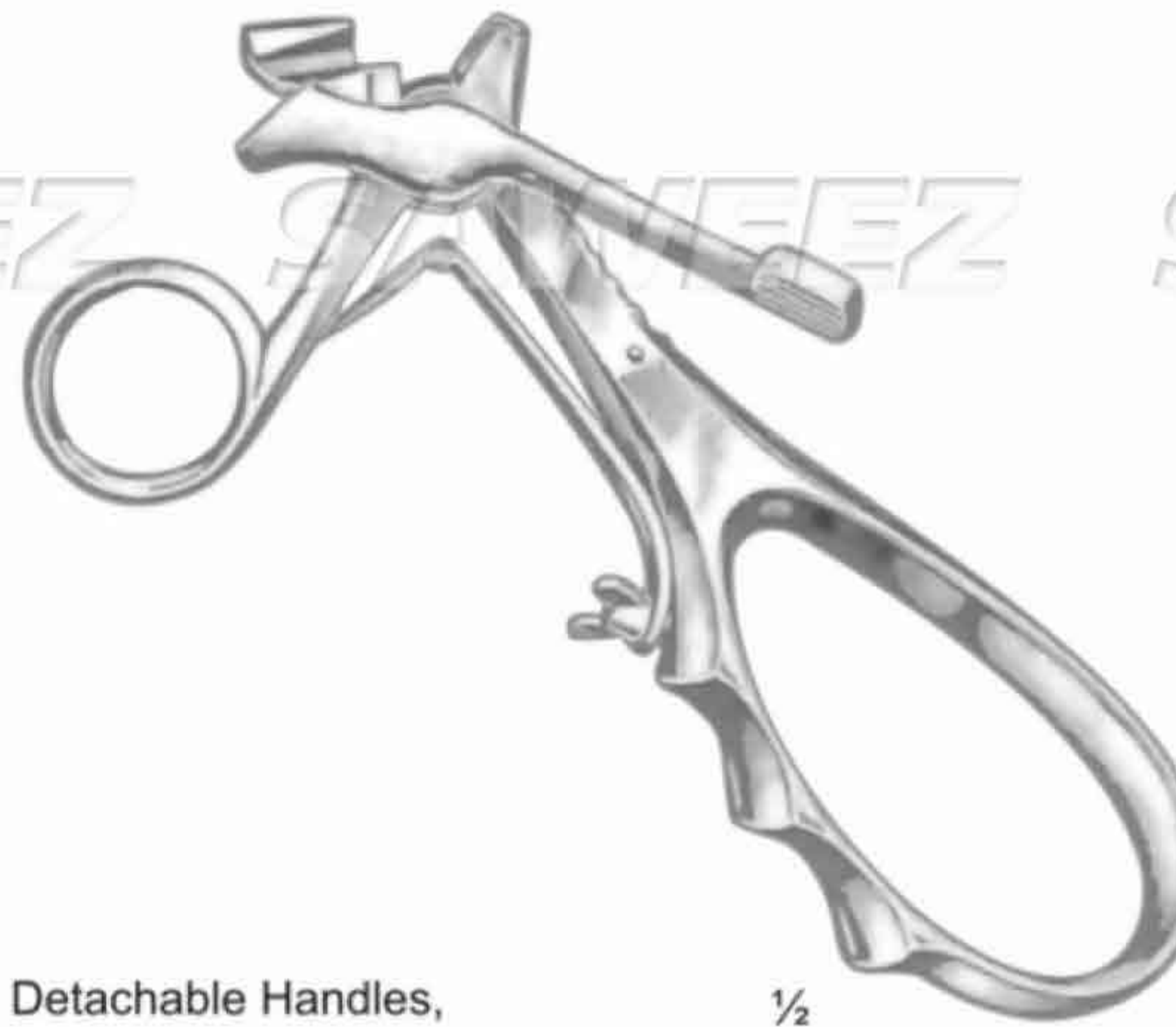
upper jaws Moveable



cm	in	SSC-47-11-61	SSC-47-11-65	SSC-47-11-69	SSC-47-11-73	SSC-47-11-77	SSC-47-11-81	SSC-47-11-85
30	12	SSC-47-11-62	SSC-47-11-66	SSC-47-11-70	SSC-47-11-74	SSC-47-11-78	SSC-47-11-82	SSC-47-11-86
40	16	SSC-47-11-63	SSC-47-11-67	SSC-47-11-71	SSC-47-11-75	SSC-47-11-79	SSC-47-11-83	SSC-47-11-87
50	20	SSC-47-11-64	SSC-47-11-68	SSC-47-11-72	SSC-47-11-76	SSC-47-11-80	SSC-47-11-84	SSC-47-11-88
60	24							



Huber
SSC-47-11-89



Bruenings
SSC-47-11-90

Universal Detachable Handles,
for use with interchangeable tip and tubes



SAWEEZ SAWEEZ SAWEEZ SAWEEZ

straight	lengths	
	cm	in.
SSC-47-11-91	20	8
SSC-47-11-92	30	12
SSC-47-11-93	40	16



Bruenings
SSC-47-11-94
20.0 cm / 8"

Laryngeal Tube for above mentioned handle



Fraenkel
SSC-47-11-95



Seiffert
SSC-47-11-96



Fraenkel
SSC-47-11-97

SAWEEZ SAWEEZ SAWEEZ SAWEEZ



Scheinmann
SSC-47-11-98



Scheinmann
SSC-47-11-99



Bruenings

⊕ SSC-47-12-00

○ SSC-47-12-01

○ SSC-47-12-02

○ SSC-47-12-03



Bruenings



Lange
SSC-47-12-04

⊕ SSC-47-12-05

⊕ SSC-47-12-06



Krause

SAWEEZ SAWEEZ SAWEEZ SAWEEZ



Krause
SSC-47-12-07

⊕ SSC-47-12-08

⊕ SSC-47-12-09

⊕ SSC-47-12-10

⊕ SSC-47-12-11



Cordes



with drawing cut



Schumacher
SSC-47-12-12

SAWEEZ SAWEEZ SAWEEZ SAWEEZ



SSC-47-12-13



SSC-47-12-14



Cordes



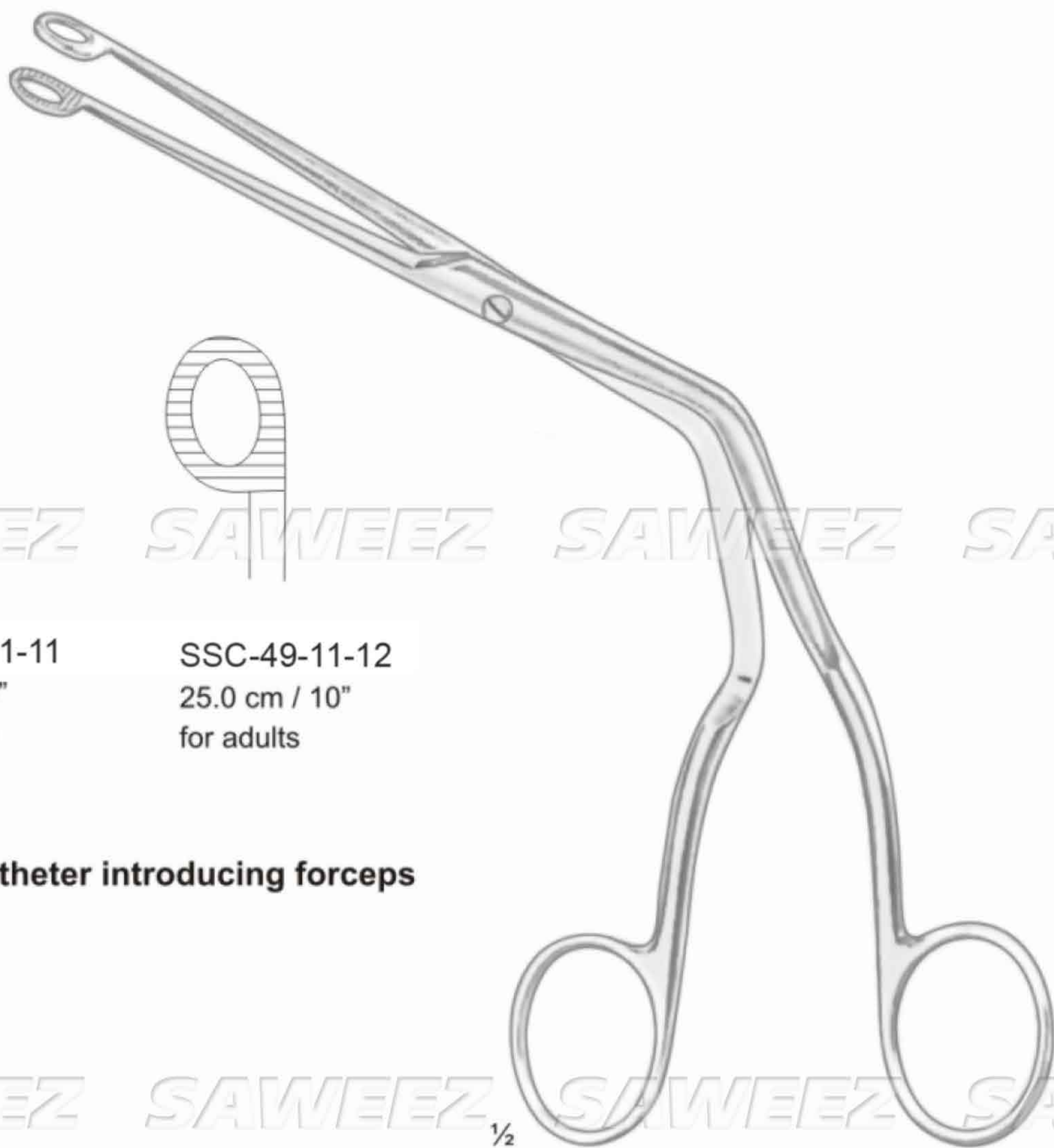
Cordes
SSC-47-12-15



Rosenberg
SSC-47-12-16



SAWEEZ SAWEEZ SAWEEZ SAWEEZ



SAWEEZ SAWEEZ SAWEEZ SAWEEZ

SSC-49-11-11
20.0 cm / 8"
for children

SSC-49-11-12
25.0 cm / 10"
for adults

Magill catheter introducing forceps

SAWEEZ SAWEEZ SAWEEZ SAWEEZ



McIntosh
SSC-49-11-13

Laryngoscope set
consisting of
Battery Handle (without batteries)
& 4 blades



SSC-49-11-15



SSC-49-11-16



SSC-49-11-17



SSC-49-11-18



SSC-49-11-14



McIntosh Fiber Optical

SSC-49-11-19

Laryngoscope set
consisting of
Battery Handle (without batteries)
& 4 blades



SSC-49-11-21



SSC-49-11-22



SSC-49-11-23



SSC-49-11-24



SSC-49-11-20

SAWEEZ SAWEEZ SAWEEZ SAWEEZ

SAWEEZ SAWEEZ SAWEEZ SAWEEZ



McIntosh Fiber Optical
SSC-49-11-25

Laryngoscope set
consisting of
Battery Handle (without batteries)
& 4 blades



SSC-49-11-27



SSC-49-11-28



SSC-49-11-29



SSC-49-11-30



SSC-49-11-26



SSC-49-11-31



SSC-49-11-32



SSC-49-11-33



SSC-49-11-34



SSC-49-11-35



Miller Fiber Optical
SSC-49-11-36

Laryngoscope set
consisting of
Battery Handle (without batteries)
& 4 blades



SSC-49-11-37



SSC-49-11-38



SSC-49-11-39



SSC-49-11-40



SSC-49-11-41



Miller
SSC-49-11-42

Laryngoscope set
consisting of
Battery Handle (without batteries)
& 4 blades



Fiber Optic McCoy
SSC-49-11-43

SAWEEZ SAWEEZ SAWEEZ SAWEEZ

SAWEEZ SAWEEZ SAWEEZ SAWEEZ

SAWEEZ SAWEEZ SAWEEZ SAWEEZ

**Otoscope Fiber Optic (Pocket)**

SSC-51-11-11

2.5 V Halogen Light

Fiber Optic for Obstruction free

Light Sealed System with Insufflator

Fitting for Pneumatic Otoscope,

Otoscope Head Made from Polymid

7 Disposable Polypropyleni Ear Spcula

Colours: Black, Blue, Pink, Green.**Mini Otoscope Fiber Optic (Pocket)**

SSC-51-11-12

2.5 V Halogen Light

Fiber Optic for Obstruction free

Light Sealed System with Insufflator

Fitting for Pneumatic Otoscope,

Otoscope Head Made from Polymid

**Ent Dignostic set**

SSC-51-11-14

Boyonet locking mounts for each instruments head to allow secure connection to battery handle.

Rheostatic ON / OFF Switch.

Otoscope with 3 Ear specula & Nasal Speculam with manual screw opening.

Ophthalmoscope head with lens wheel featuring 25 corective lenses.

Chrome plated bent arm larynx with light.

2 mirrirs 4mm & 5mm.

Disposable tongue depressor with holder.

**Otoscope**

SSC-51-11-13

Boyonet locking mounts for each instruments head to allow secure connection to battery handle.

Rheostatic ON / OFF Switch.

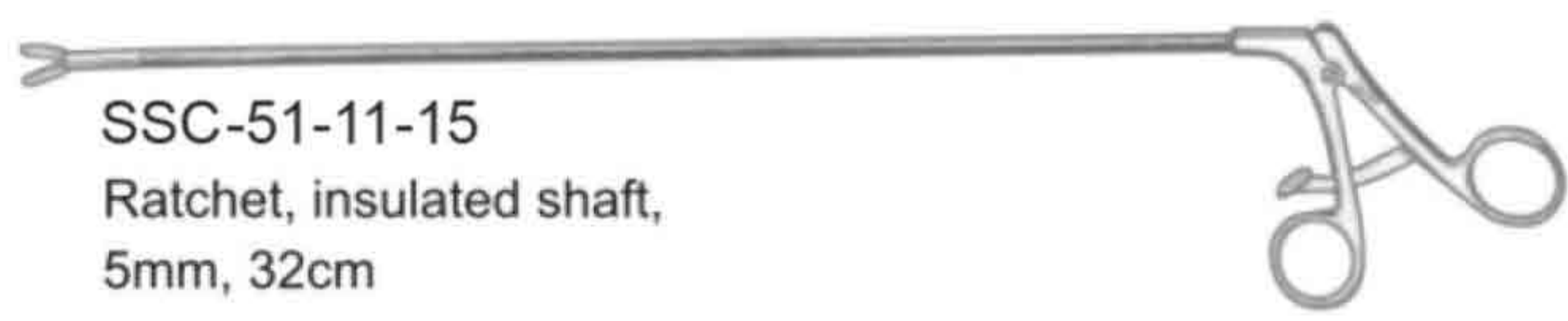
Otoscope with 3 Ear specula.



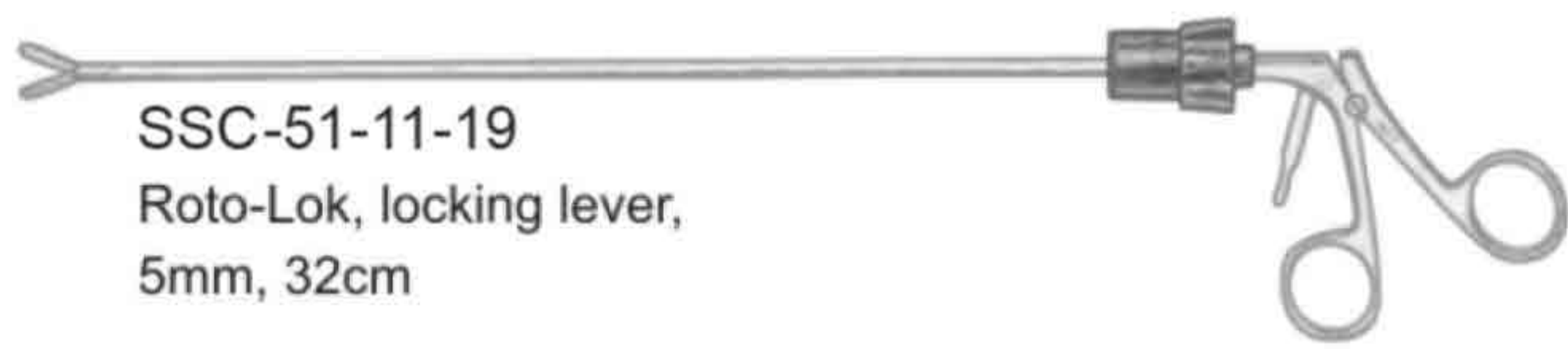
Grasping Forceps
Straight, serrated jaws with proximal recess, double action.



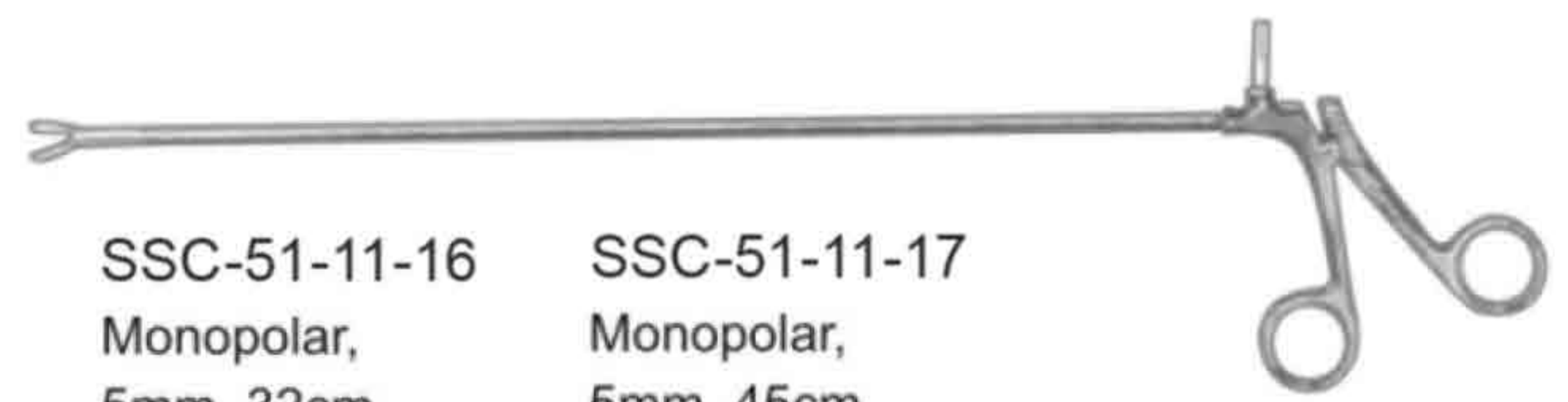
SSC-51-11-18
Roto-Lok, ratchet,
5mm, 32cm



SSC-51-11-15
Ratchet, insulated shaft,
5mm, 32cm



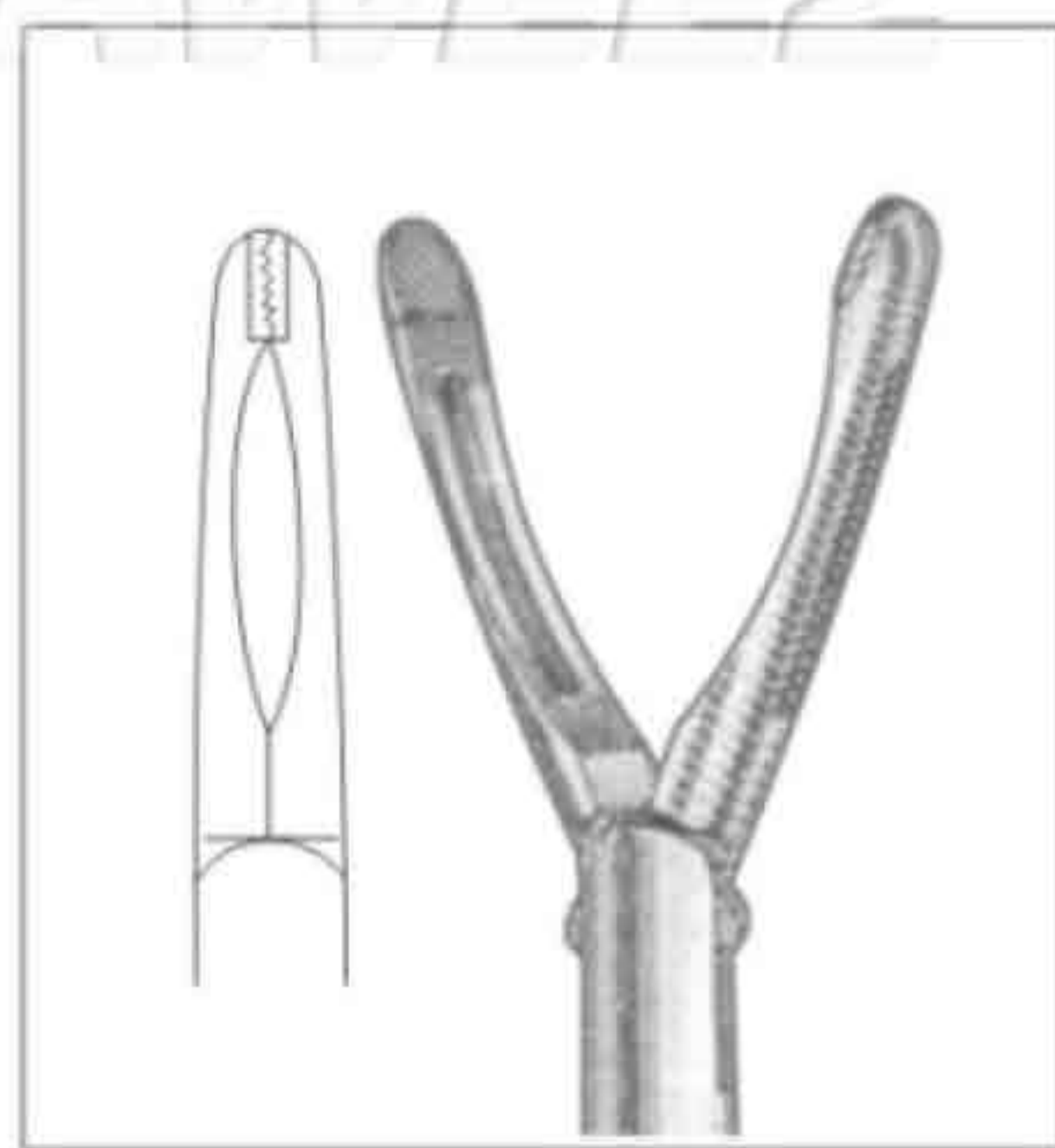
SSC-51-11-19
Roto-Lok, locking lever,
5mm, 32cm



SSC-51-11-16 SSC-51-11-17
Monopolar, Monopolar,
5mm, 32cm 5mm, 45cm



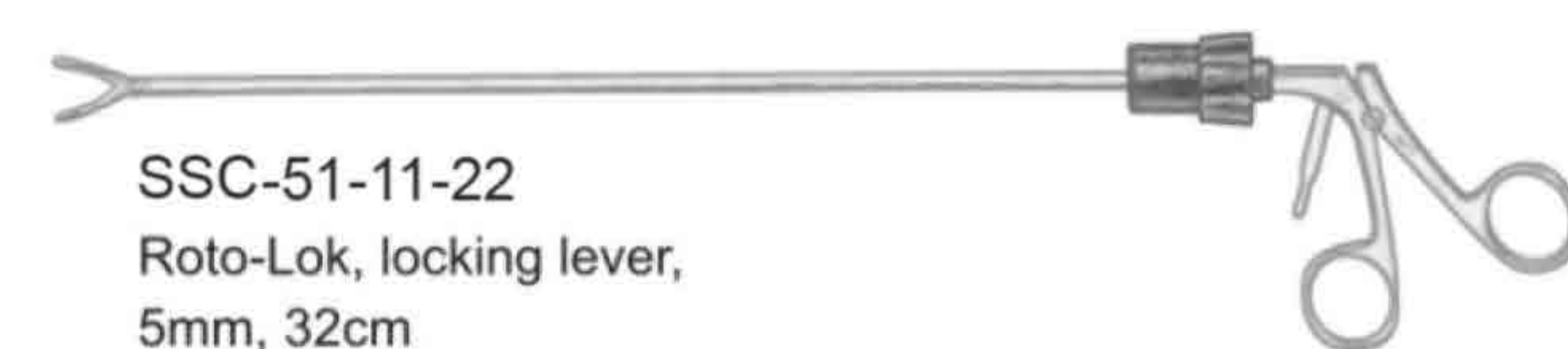
SSC-51-11-20
Roto-Cam, monopolar,
5mm, 32cm



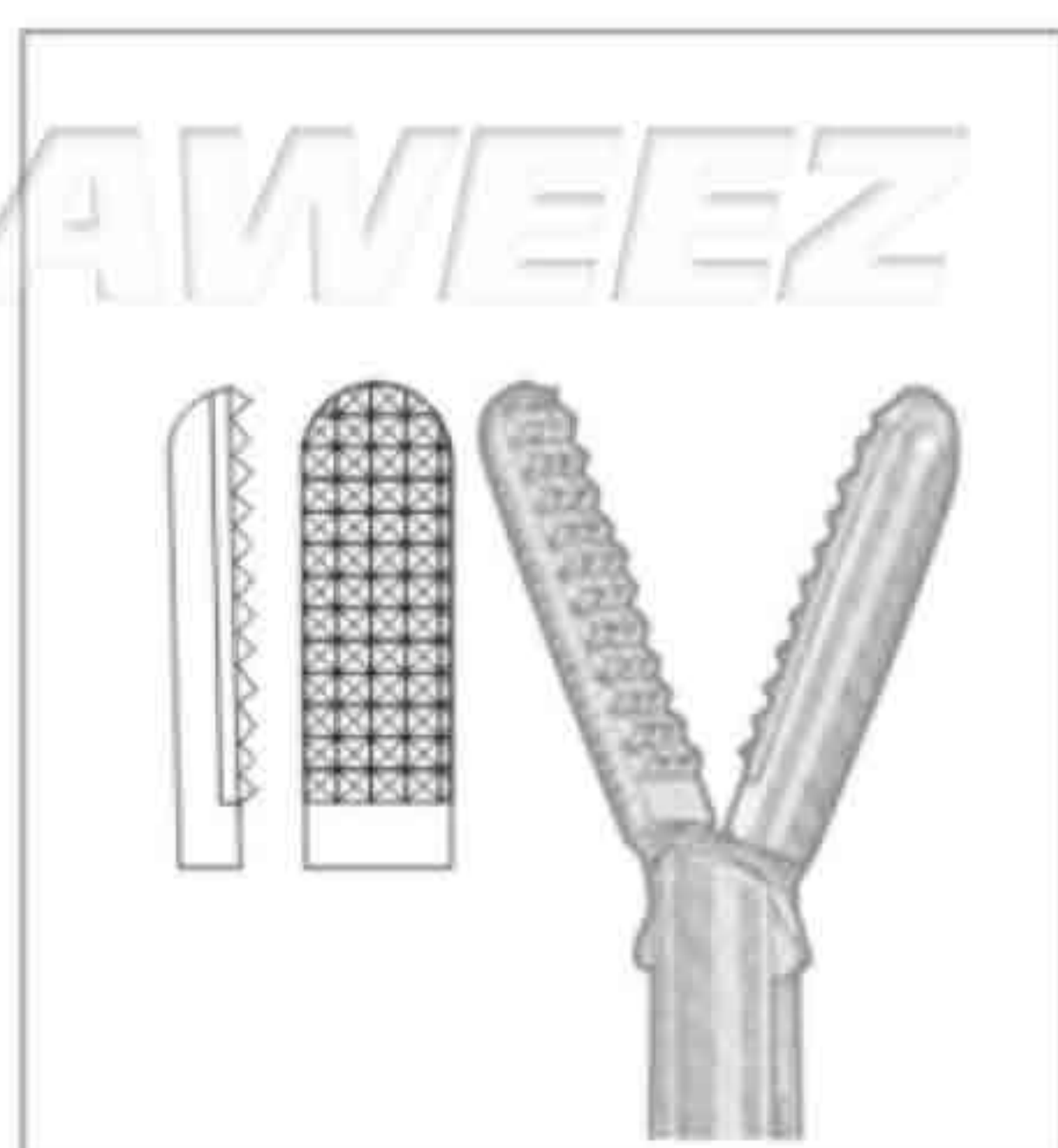
Tc Grasping Forceps
Double action
Carb-Bite tips, 22mm long
jaws maintain firm grasp on
delicate tissue, double action.



SSC-51-11-21
Roto-Lok, ratchet,
5mm, 32cm



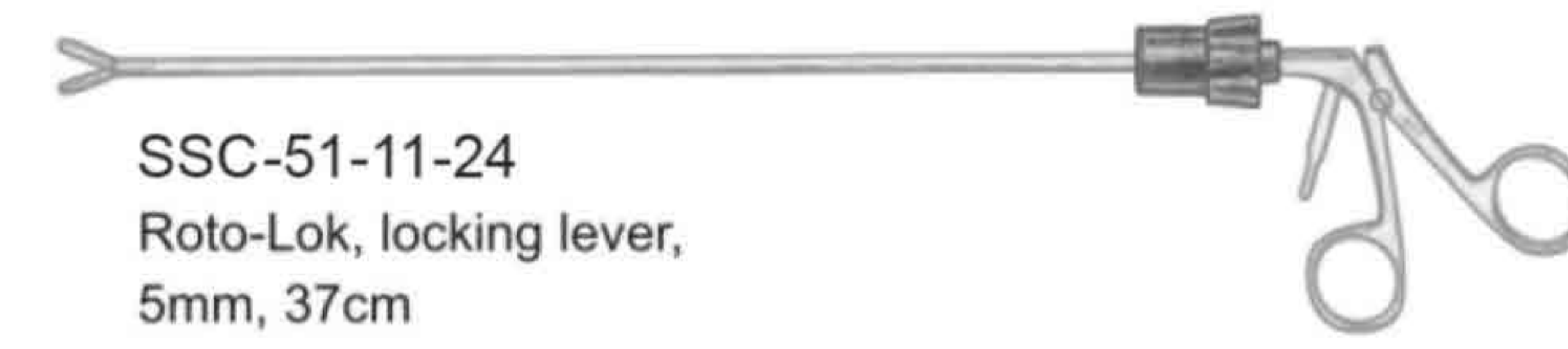
SSC-51-11-22
Roto-Lok, locking lever,
5mm, 32cm



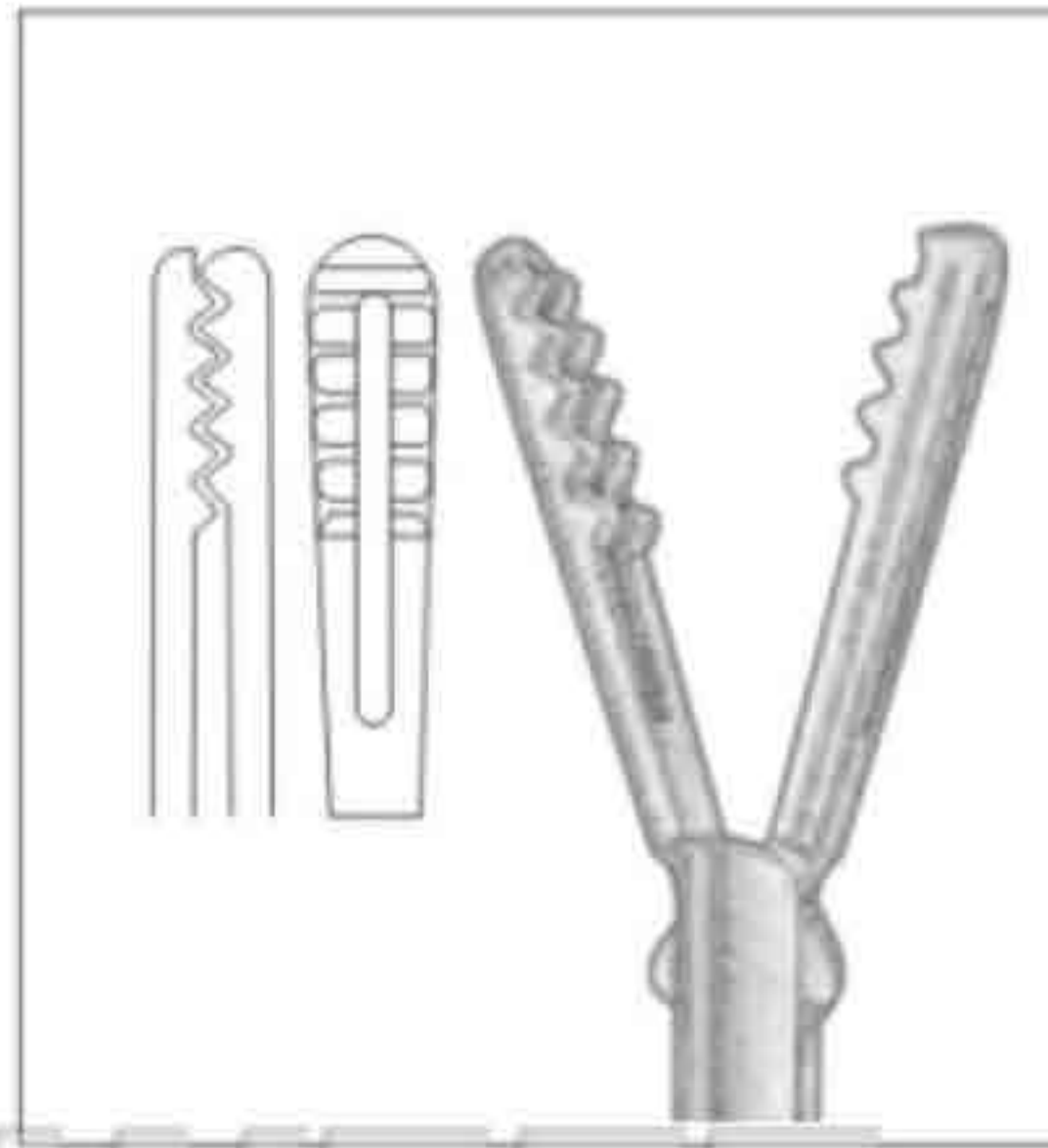
Strong Tc Grasping Forceps
Heavy Carb-Bite inserts
allow jaws to maintain firm
hold on tissue, double action.



SSC-51-11-23
Roto-Lok, ratchet,
5mm, 37cm



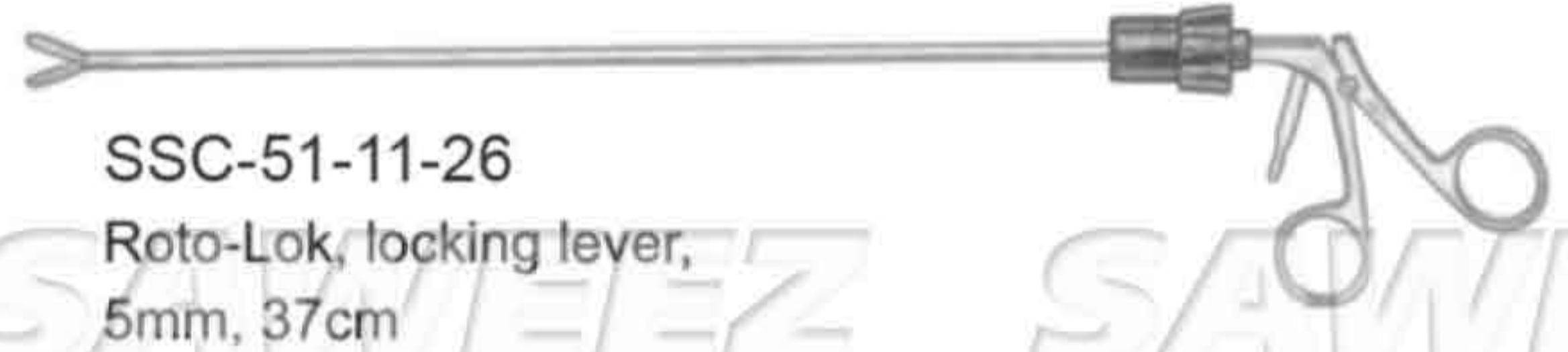
SSC-51-11-24
Roto-Lok, locking lever,
5mm, 37cm



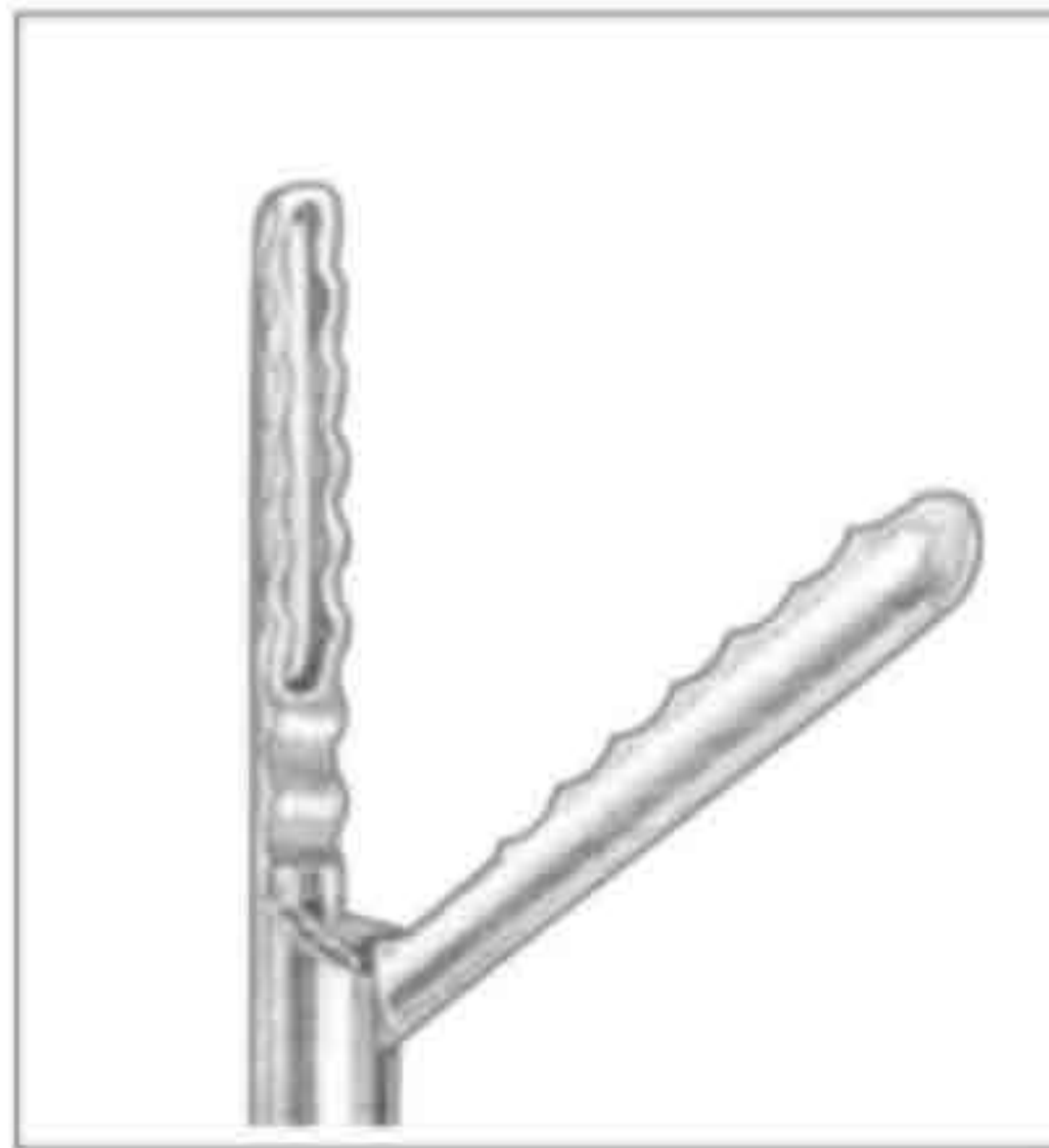
Grabber Forceps
long, fenestrated jaws with interlocking wave-like serrations for strong hold, double action



SSC-51-11-25
Roto-Lok, ratchet,
5mm, 37cm



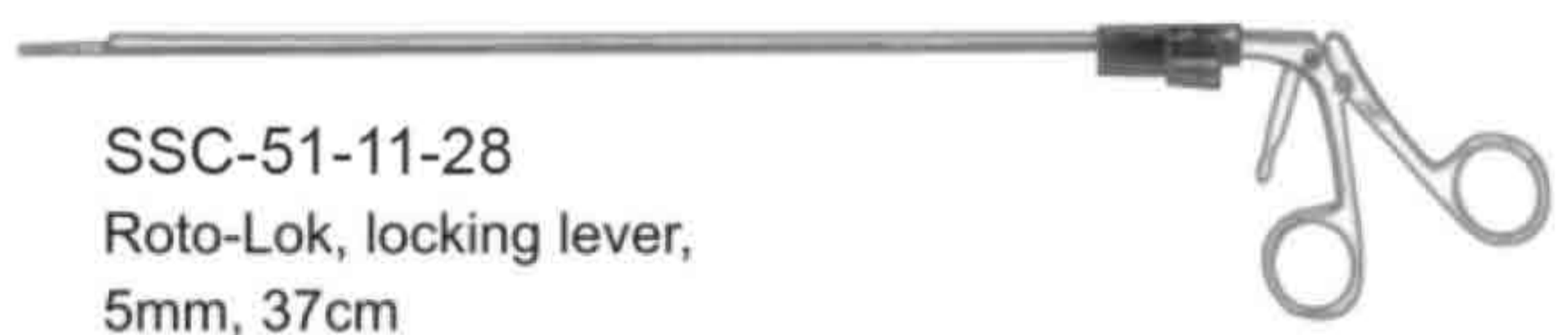
SSC-51-11-26
Roto-Lok, locking lever,
5mm, 37cm



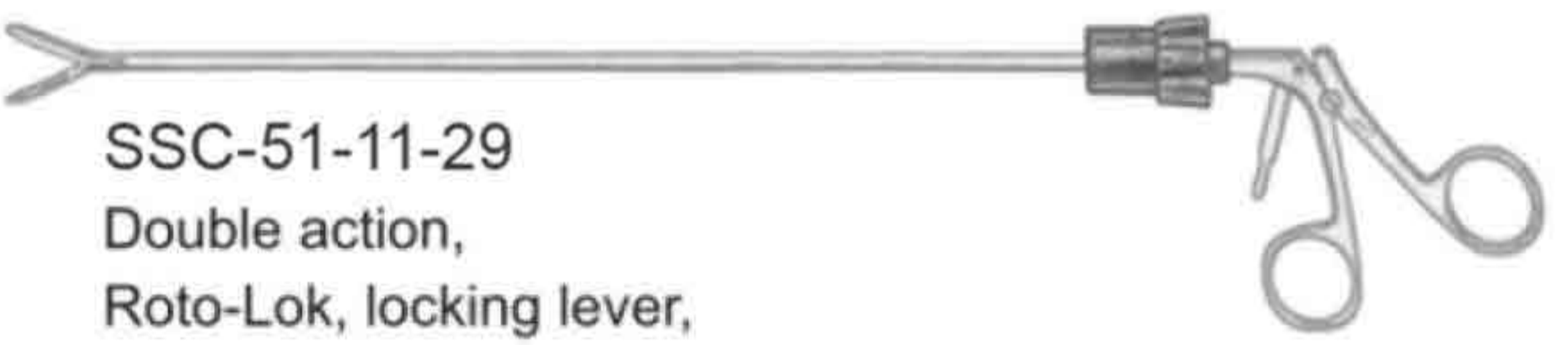
Fundus Grabber Forceps
long, beveled-edge jaws permit a large purchase on tissue and maintain a strong hold.



SSC-51-11-27
Roto-Lok, ratchet,
5mm, 37cm



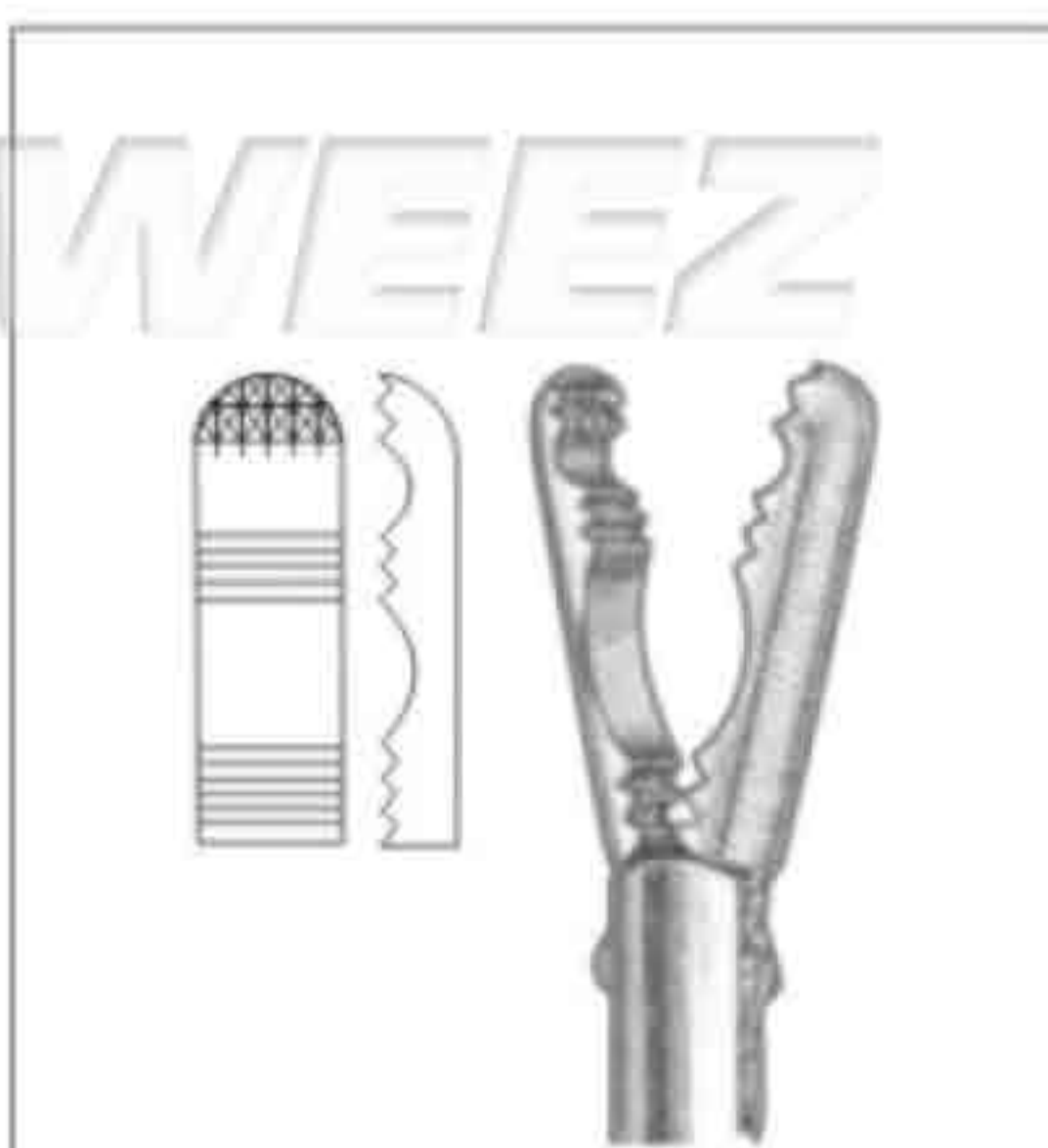
SSC-51-11-28
Roto-Lok, locking lever,
5mm, 37cm



SSC-51-11-29
Double action,
Roto-Lok, locking lever,
5mm, 37cm



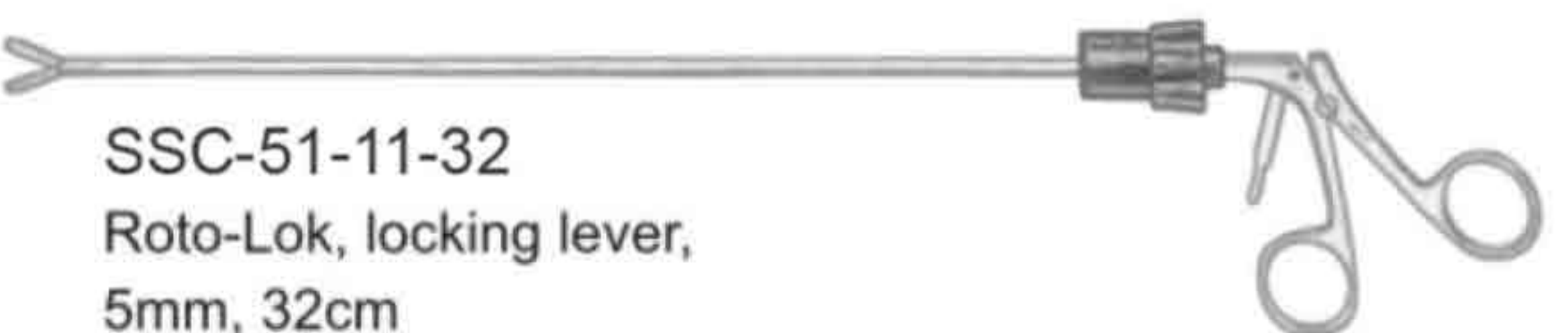
SSC-51-11-30
Double action,
Roto-Lok, ratchet,
5mm, 37cm



Dual-Cup Grabber Forceps
Double cup design increases surface area contact which improves hold on tissue, double action.



SSC-51-11-31
Roto-Lok, ratchet,
5mm, 32cm



SSC-51-11-32
Roto-Lok, locking lever,
5mm, 32cm



Retraction Grasping Forceps

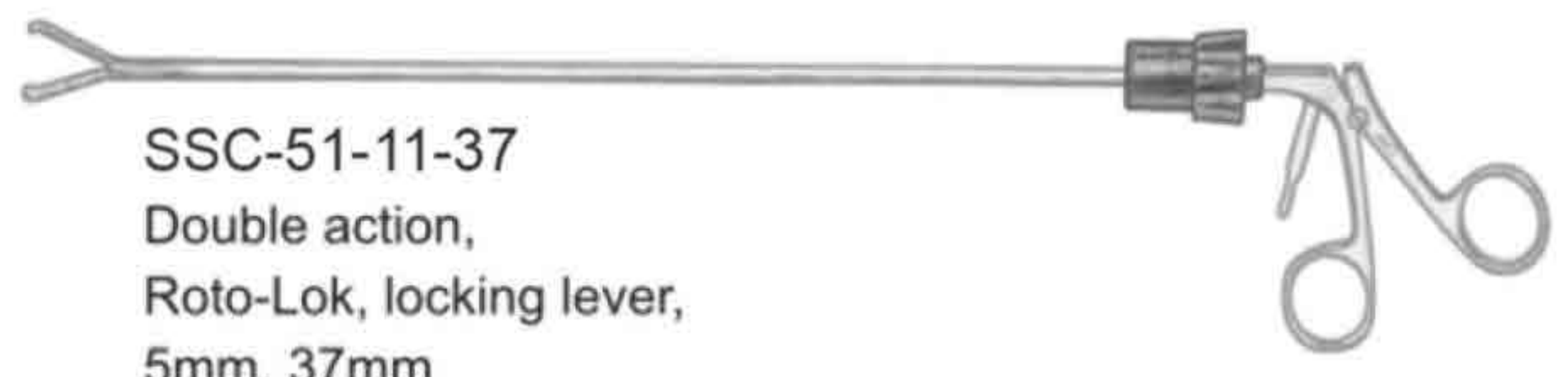
Long-riged jaws with 2 x 3 blunt interdigitating teeth for strong grasp of heavy tissue.



SSC-51-11-35
Roto-Lok, ratchet,
5mm, 37mm



SSC-51-11-36
Roto-Lok, locking lever,
5mm, 37mm



SSC-51-11-37
Double action,
Roto-Lok, locking lever,
5mm, 37mm



SSC-51-11-38
Double action,
Roto-Lok, ratchet,
5mm, 37mm



Atrau-Allis Grasping Forceps

Unique jaw design offers strong atraumatic grasp, double action

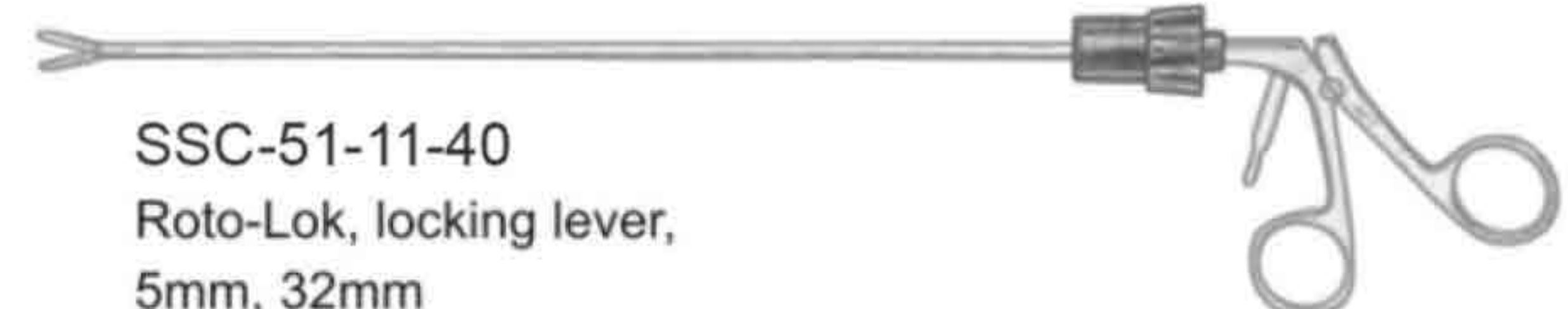


SSC-51-11-39
Roto-Lok, ratchet,
5mm, 32mm



SSC-51-11-33
Ratchet, insulated shaft,
5mm, 32mm

SSC-51-11-34
Ratchet, insulated shaft,
5mm, 45mm



SSC-51-11-40
Roto-Lok, locking lever,
5mm, 32mm



Atrau-Allis LJ Grasping Forceps

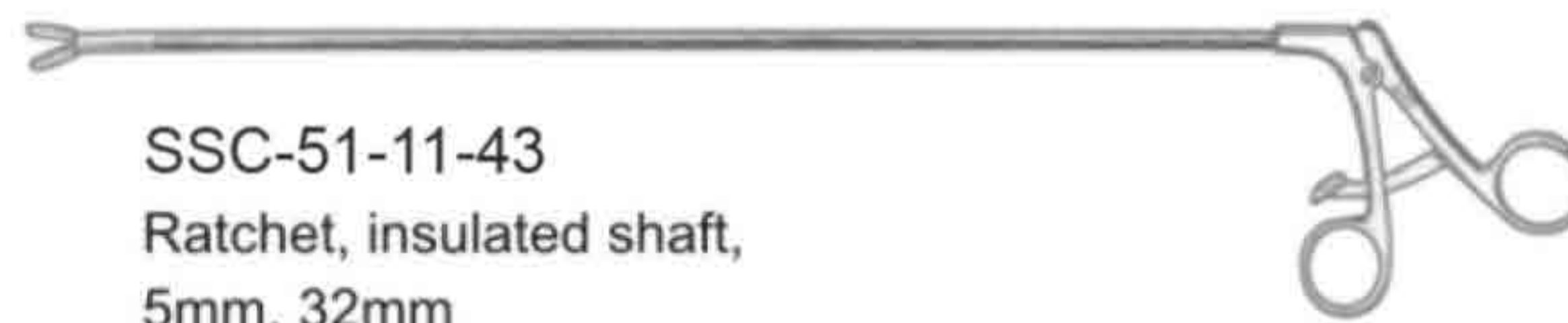
Unique jaw design in 20mm length offers strong atraumatic grasp, double action

SSC-51-11-41
Roto-Lok, ratchet,
5mm, 37mm

SSC-51-11-42
Roto-Lok, locking lever,
5mm, 37mm



Allis Grasping Forceps
Interlocking distal teeth with fine-serrated inner jaws, double action.



SSC-51-11-43
Ratchet, insulated shaft,
5mm, 32mm

SAWEEZ

SAWEEZ

SAWEEZ

SAWEEZ



Retrograde Grasping Forceps
Retrograde, deep-serrated teeth allow for non-slip hold, double action.



SSC-51-11-45
Ratchet,
5mm, 32mm

SAWEEZ

SAWEEZ

SAWEEZ

SAWEEZ



Grasping and Dissecting Forceps
Cup-shaped, toothed jaws, double action.



SSC-51-11-46
Monopolar
5mm, 32mm

SAWEEZ

SAWEEZ

SAWEEZ

SAWEEZ



Grasping and Extracting Forceps
Retrograde, deep-serrated teeth



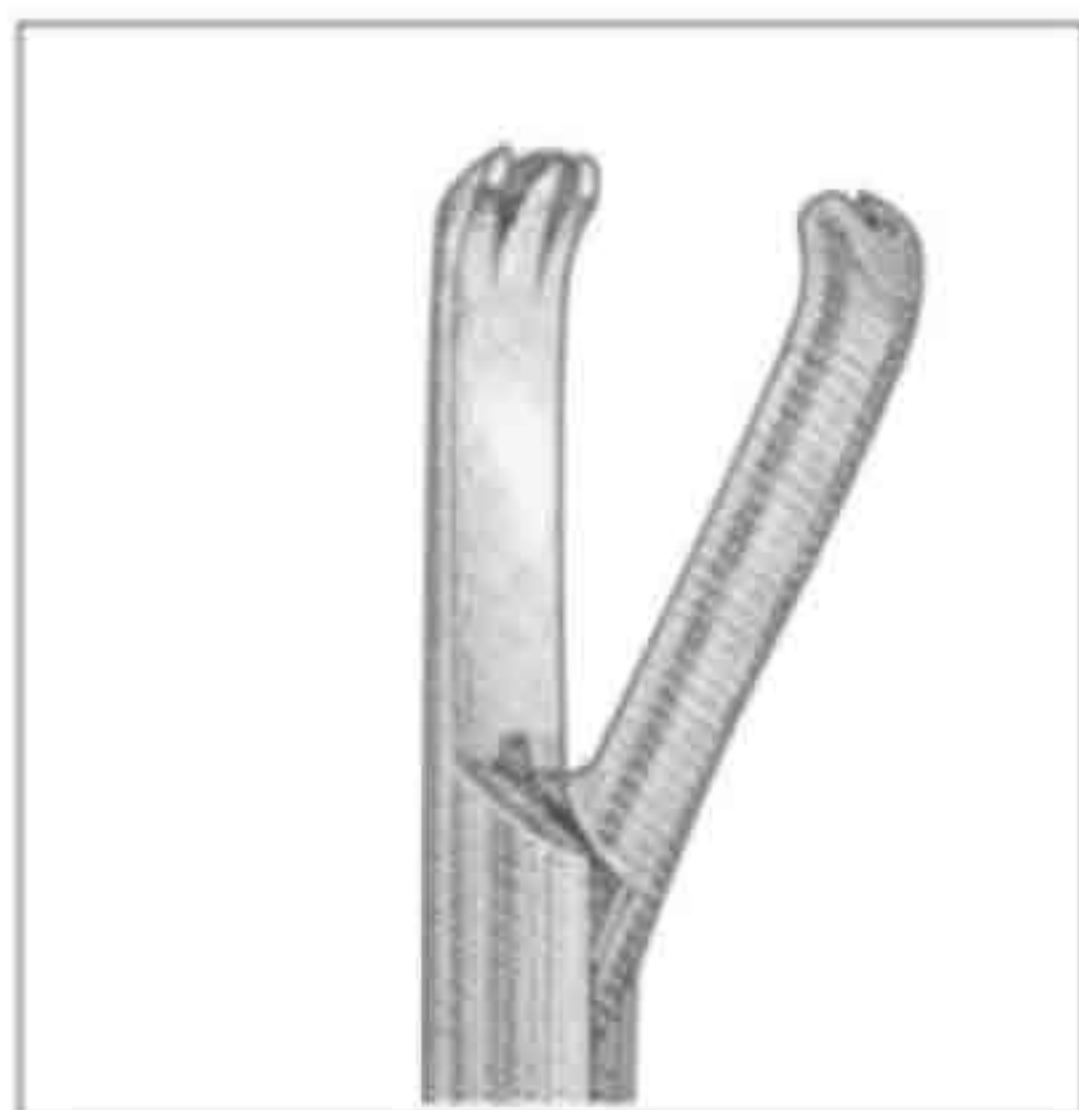
SSC-51-11-47
Spring-loaded
10mm, 32mm



Claw Forceps
2x3 interlocking teeth
for penetrating hold and
extraction of tissue.



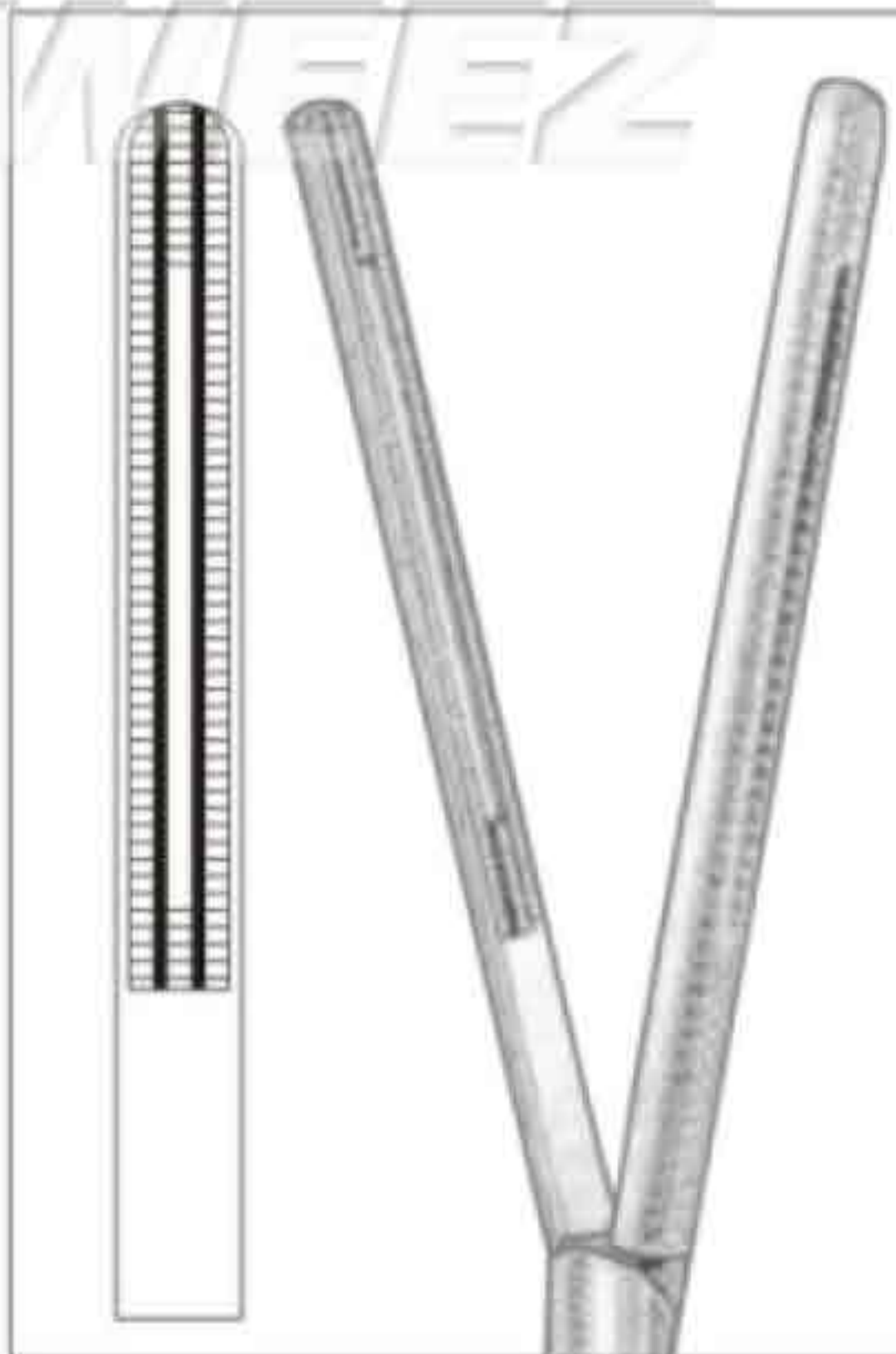
SSC-51-11-48
Spring-loaded
10mm, 32mm



Claw Forceps
2x3 interlocking teeth
for penetrating hold and
extraction of tissue.



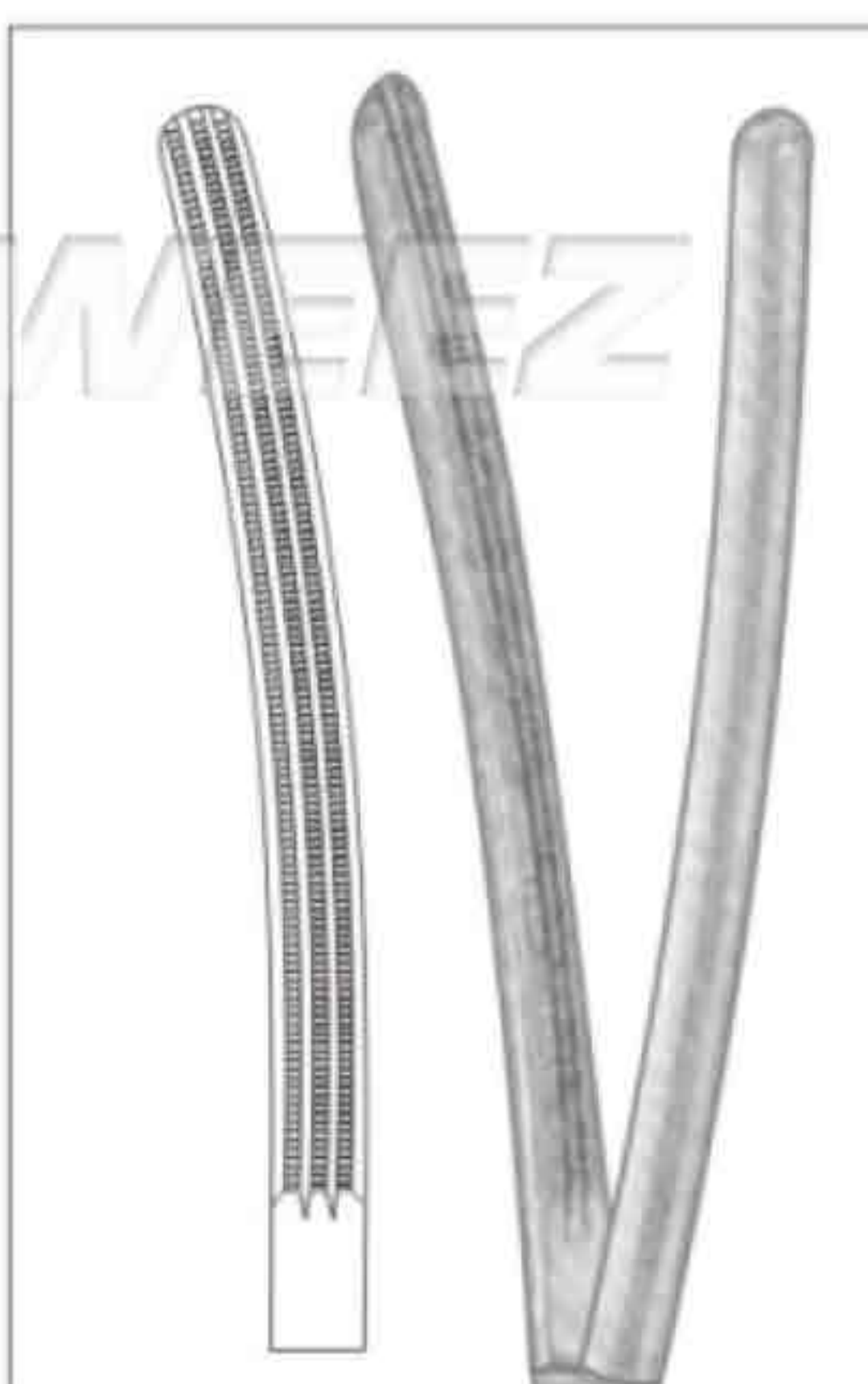
SSC-51-11-49
Spring-loaded
5mm, 32mm



Debakey Forceps
Fenestrated 45mm long jaws
with Debakey-type teeth,
double action.



SSC-51-11-50
Ratchet,
5mm, 32mm



Debakey Forceps
Fenestrated 55mm long jaws
with Debakey-type teeth,
double action.

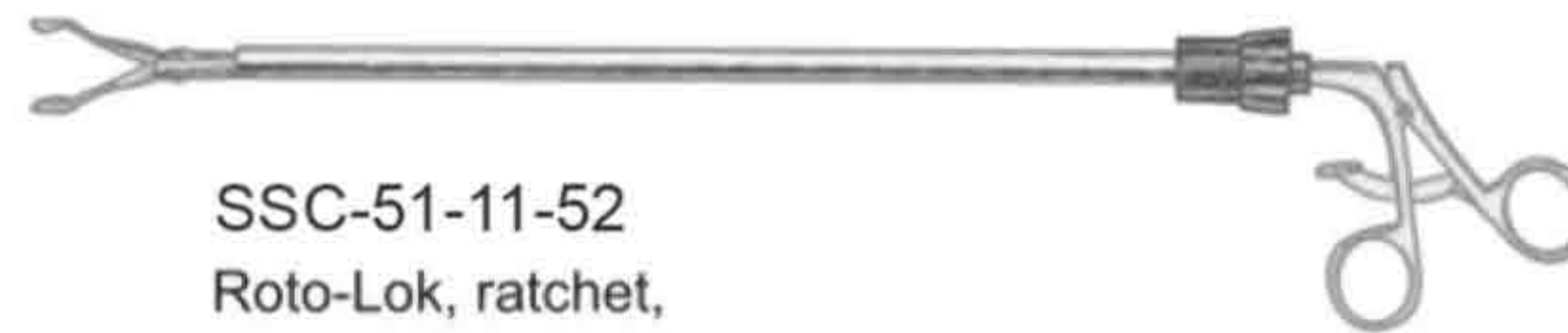


SSC-51-11-51
Roto-Lok, ratchet,
10mm, 37mm



Paddle Babcock Forceps

Flat paddles with fine, straight Serrations for atraumatic hold of delicate tissue, double action.

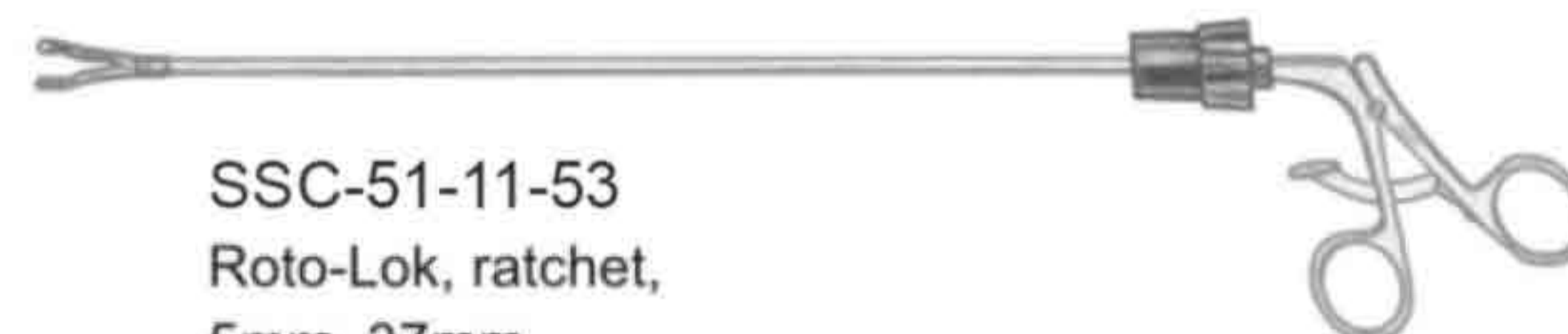


SSC-51-11-52
Roto-Lok, ratchet,
10mm, 37mm

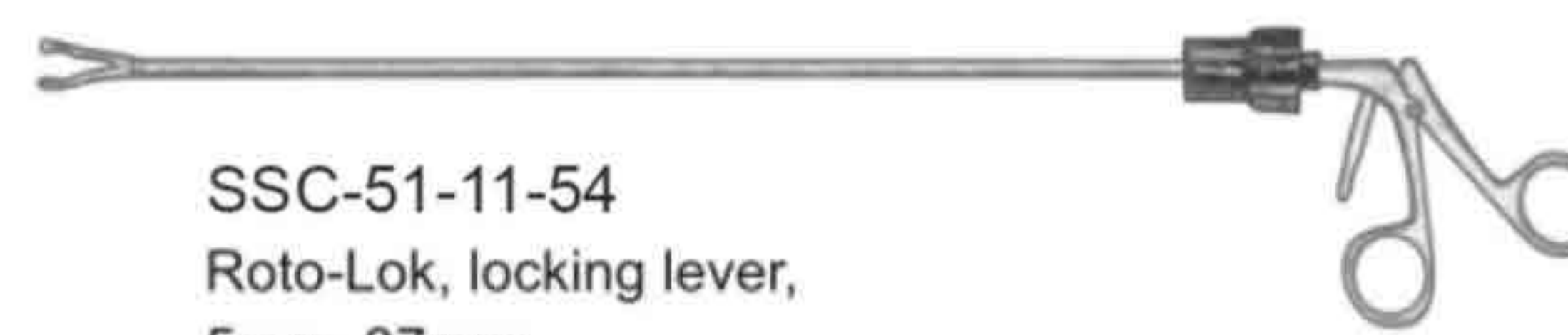


Paddle Babcock Forceps

Flat paddles with fine, straight Serrations for atraumatic hold of delicate tissue, double action.



SSC-51-11-53
Roto-Lok, ratchet,
5mm, 37mm

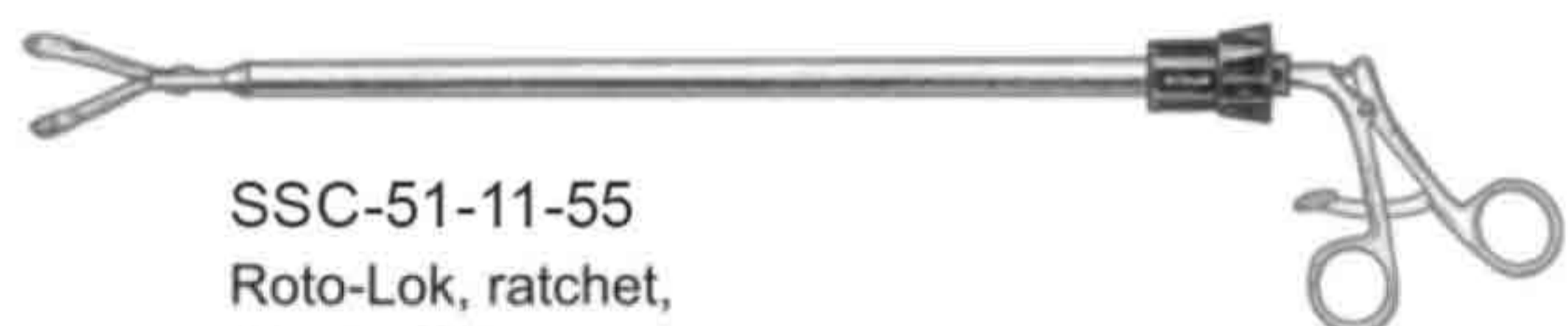


SSC-51-11-54
Roto-Lok, locking lever,
5mm, 37mm

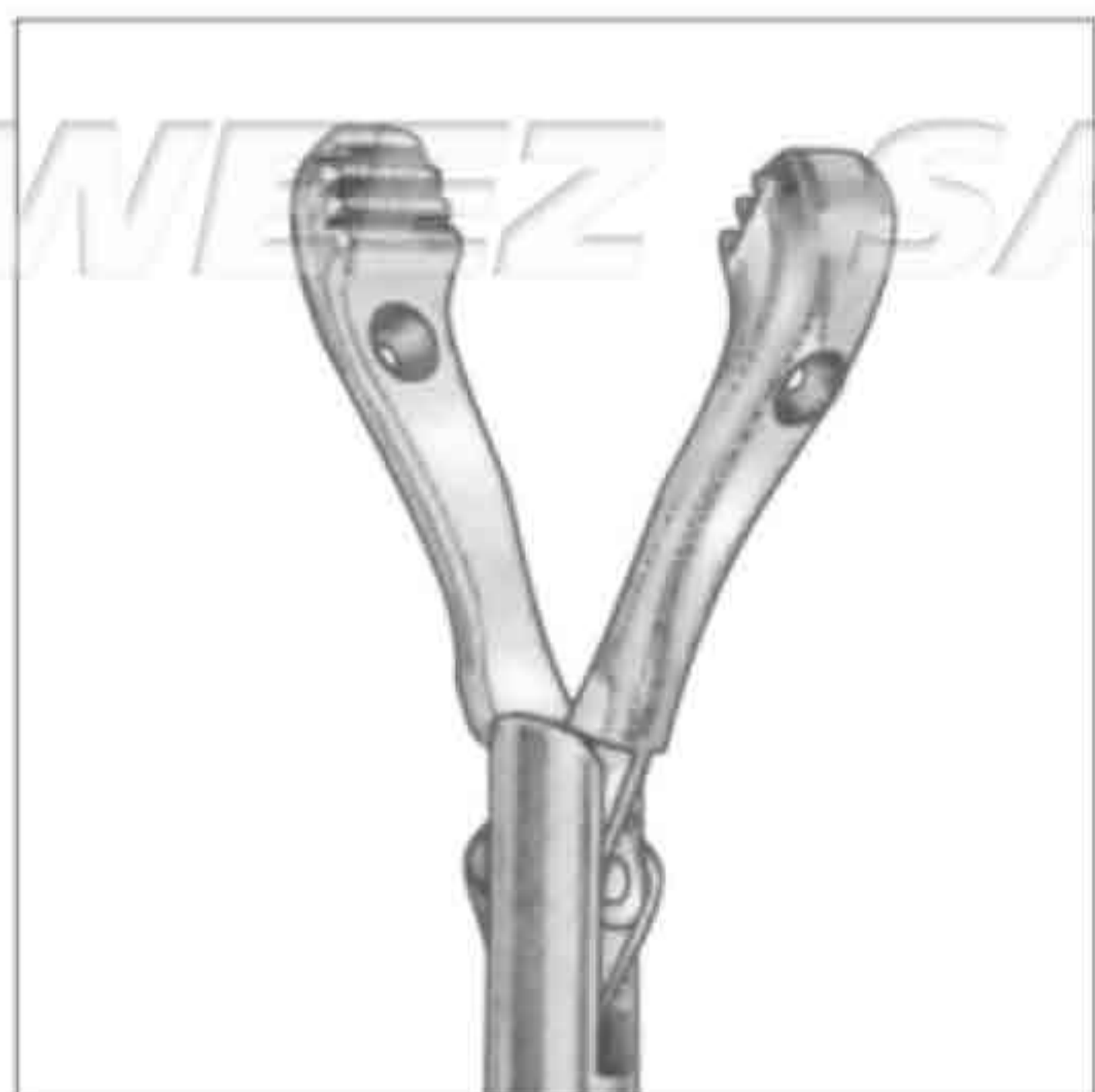


Babcock Forceps

Traditional style Babcock jaws designed with six rows of fine serrations for atraumatic, yet secure grasp of bowel and other delicate tissue, double action.



SSC-51-11-55
Roto-Lok, ratchet,
10mm, 37mm

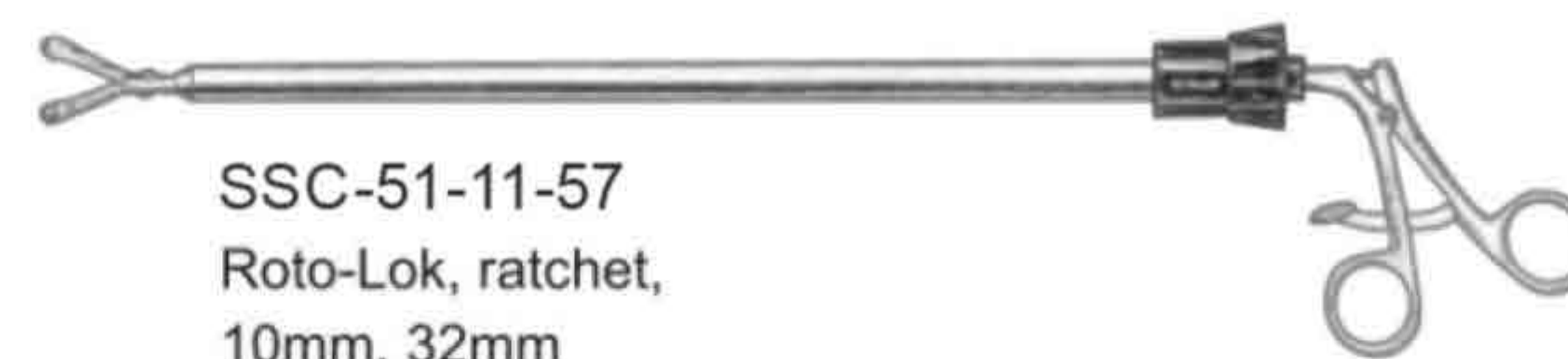


Babcock Forceps

Rounded jaws with 2x3 rows of De-Bakey-type teeth for atraumatic, yet secure grasp of bowel and other delicate tissue, double action



SSC-51-11-56
Ratchet,
10mm, 32mm



SSC-51-11-57
Roto-Lok, ratchet,
10mm, 32mm

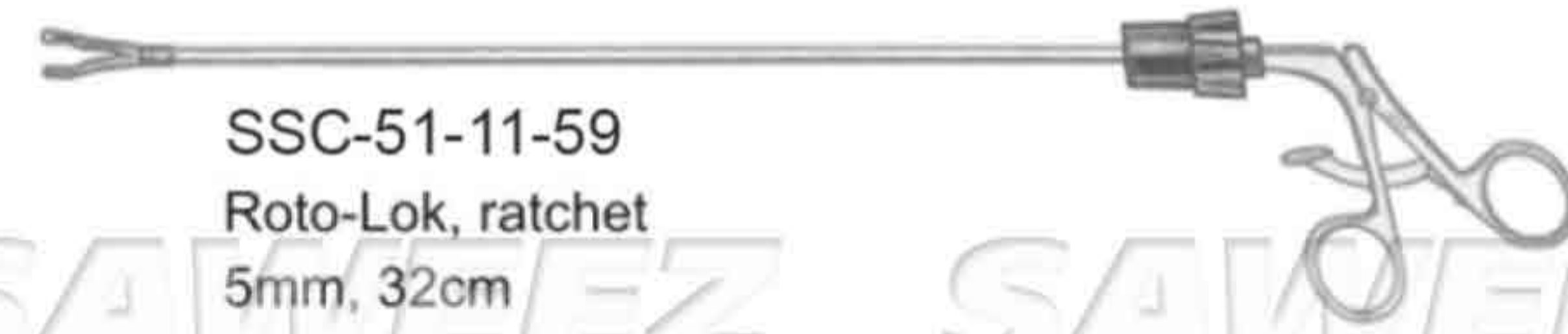


Babcock Forceps

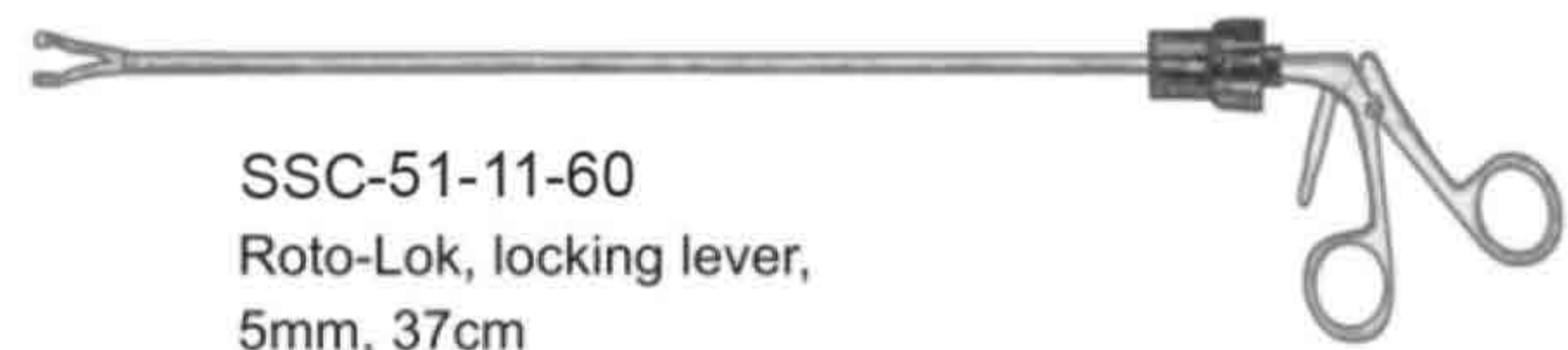
Traditional design for grasping delicate tissue, double action.



SSC-51-11-58
Ratchet
5mm, 32cm



SSC-51-11-59
Roto-Lok, ratchet
5mm, 32cm

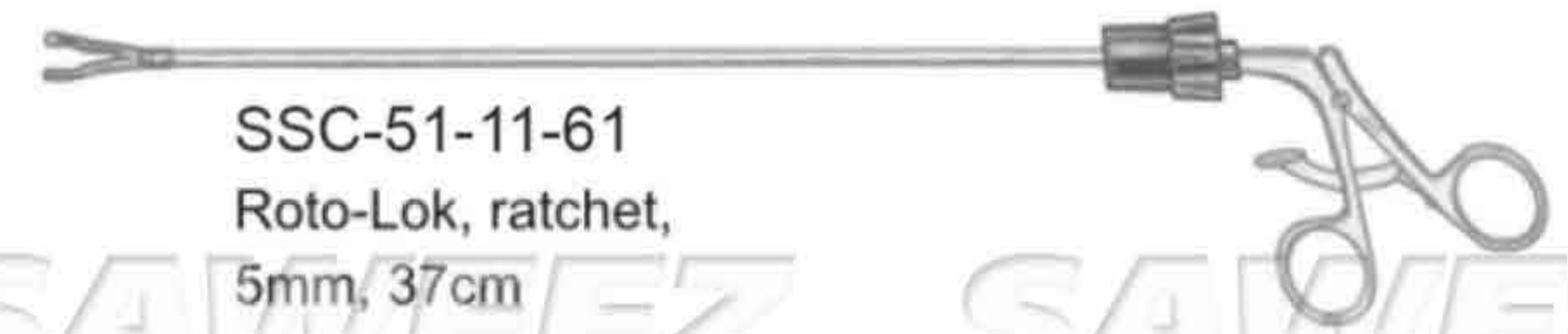


SSC-51-11-60
Roto-Lok, locking lever,
5mm, 37cm

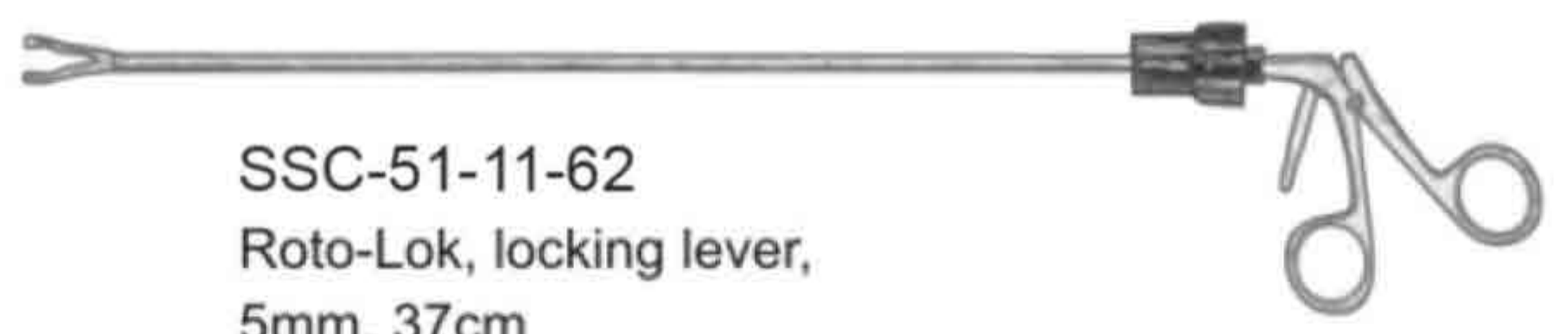


Swanstron Grasping Forceps

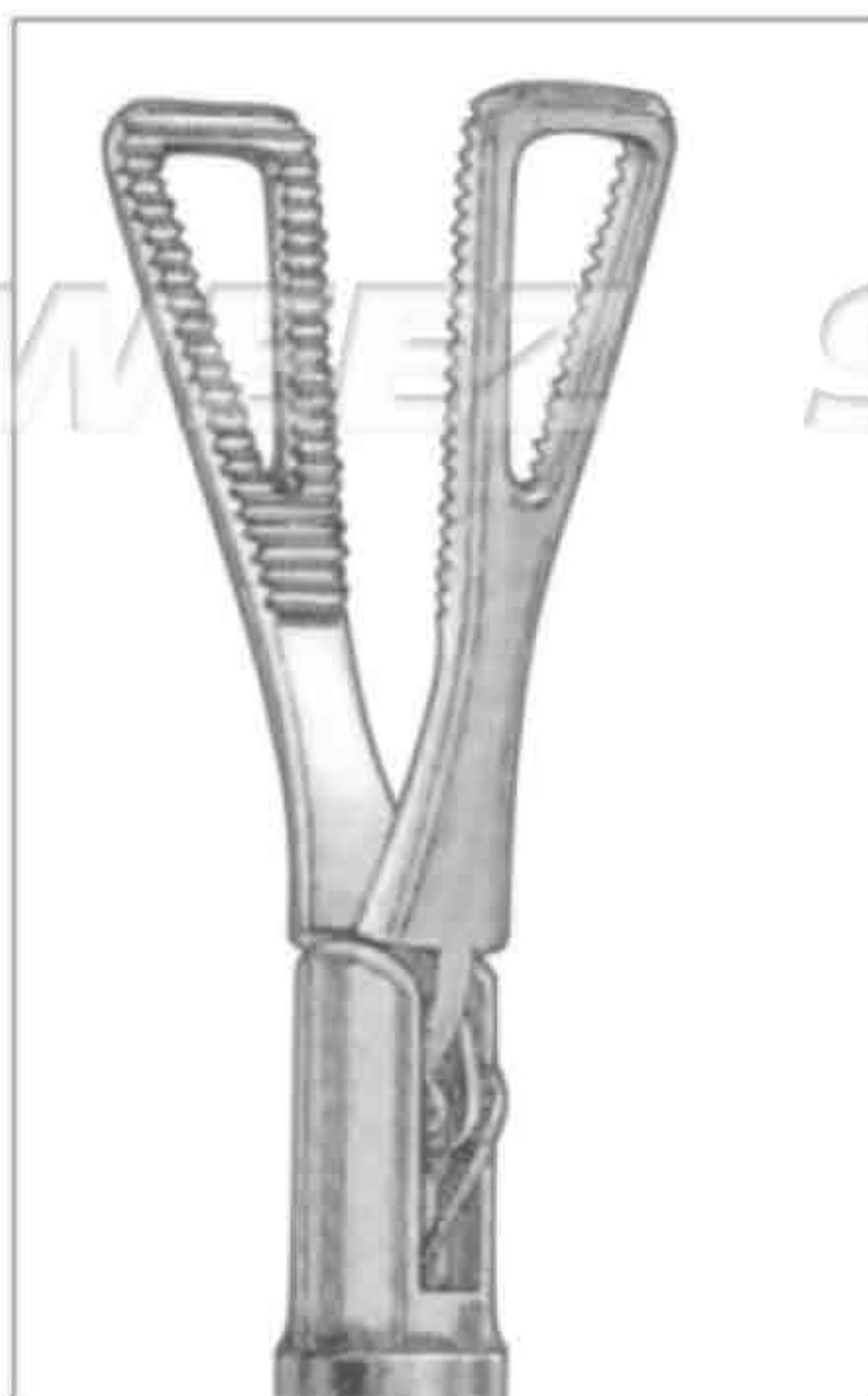
Unique design of 1x2 De-Bakey-type teeth with triangular fenestration provides an effective hold with atraumatic grasp, double action.



SSC-51-11-61
Roto-Lok, ratchet,
5mm, 37cm



SSC-51-11-62
Roto-Lok, locking lever,
5mm, 37cm



Duval Grasping Forceps

Triangular jaws with deep-serrated surfaces for non-slip, firm grasp of tissue, double action.



SSC-51-11-63
Ratchet,
10mm, 32cm



SSC-51-11-64
Roto-Lok ratchet,
10mm, 32cm



Russian Grasping Forceps
40mm long jaws with heavy serration for effective tissue, double action.



SSC-51-11-65
Ratchet,
10mm, 32cm

SAWEEZ

SAWEEZ

SAWEEZ

SAWEEZ



Foerster Sponge Forceps
45mm jaws firmly hold tissue, double action.



SSC-51-11-66
Ratchet,
10mm, 32cm

SAWEEZ

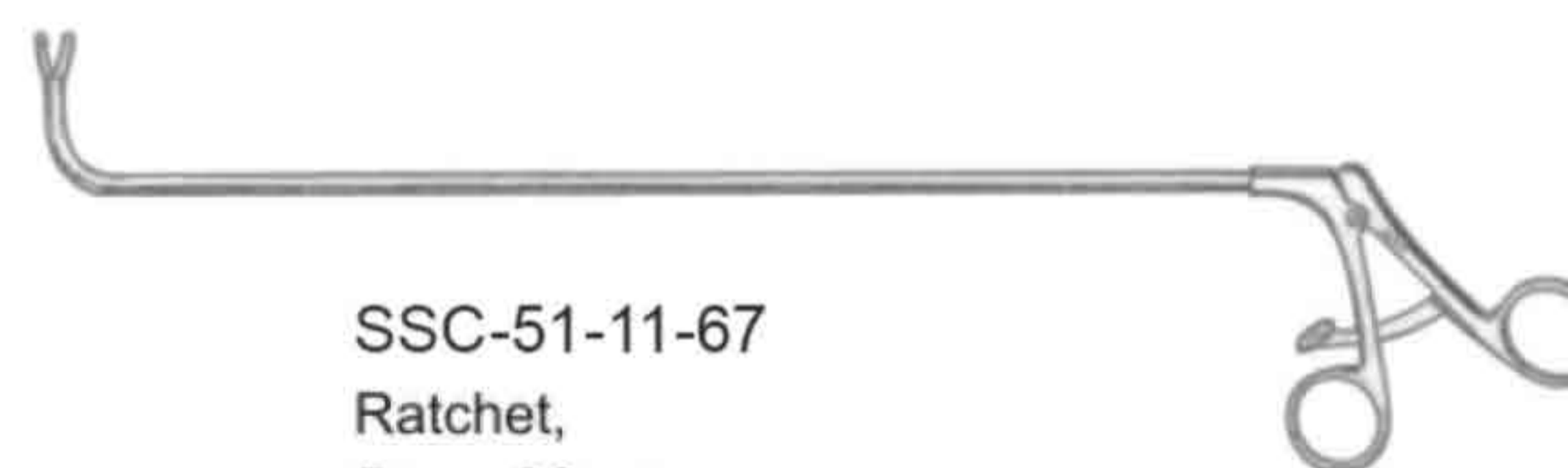
SAWEEZ

SAWEEZ

SAWEEZ



Hunter² Clamps
Right-angle shaft with Atrau-Allis teeth for secure grasp and manipulation of tissue around structures, e.g stomach/esophagus in fundoplication, double action.



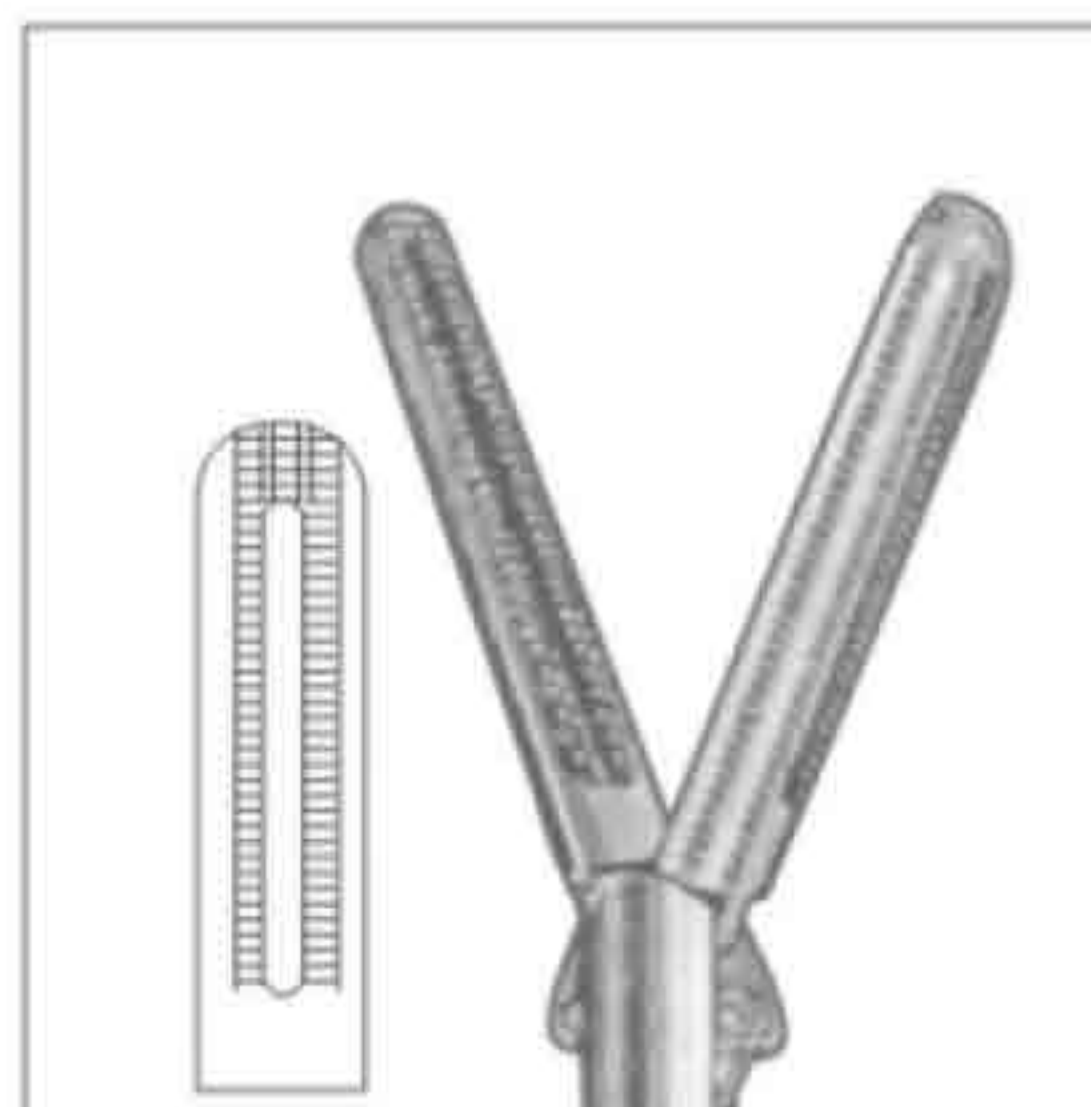
SSC-51-11-67
Ratchet,
5mm, 32cm

SAWEEZ

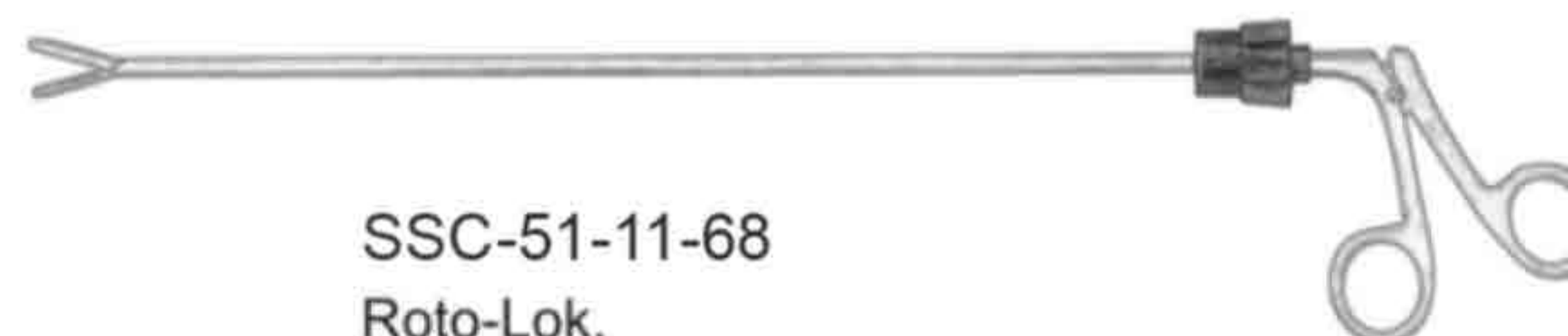
SAWEEZ

SAWEEZ

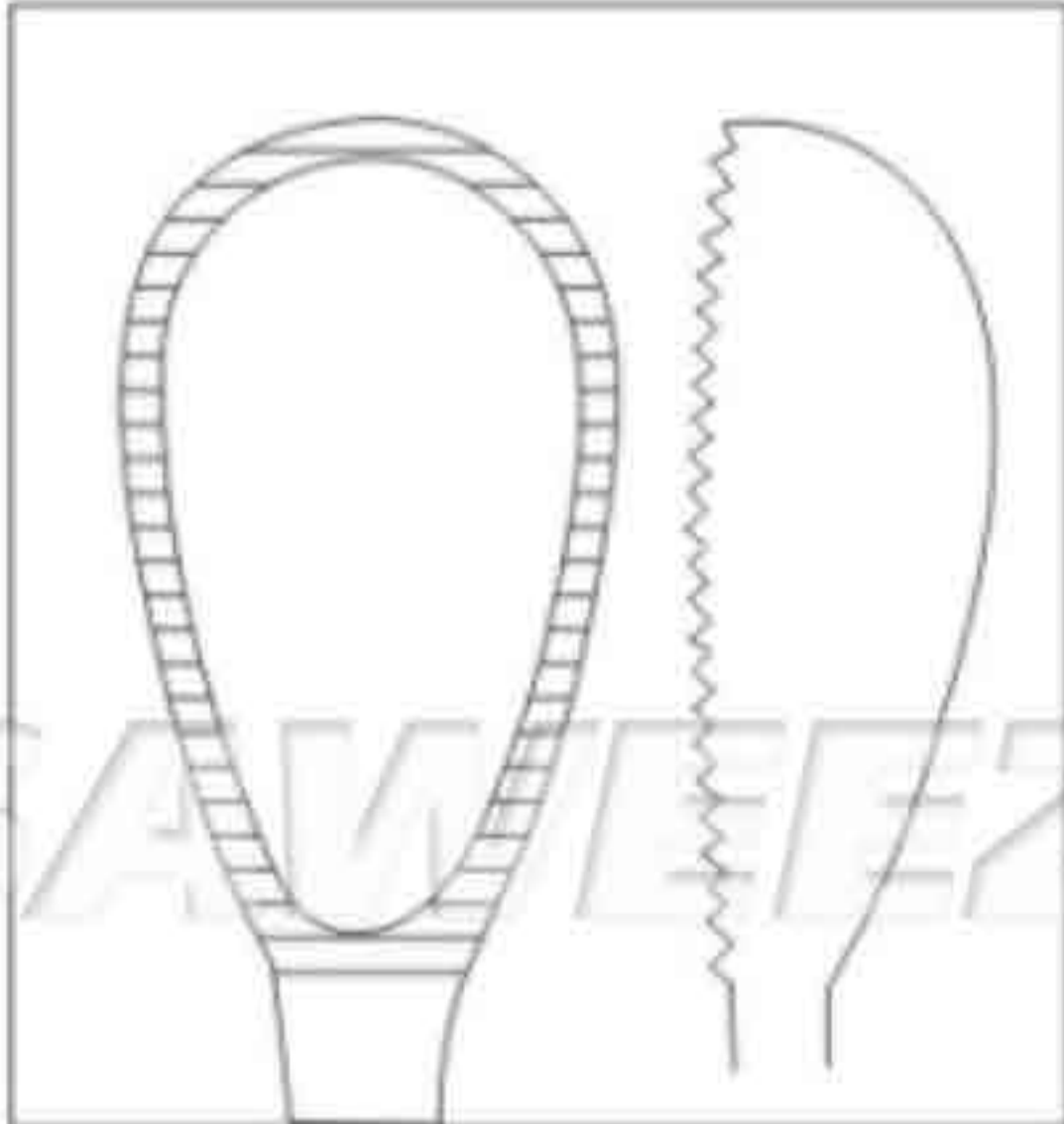
SAWEEZ



Hunter² Bowel Grasper
Fenestrated, 20mm jaws for atraumatic manipulation of delicate tissue, e.g bowel stomach, double action.

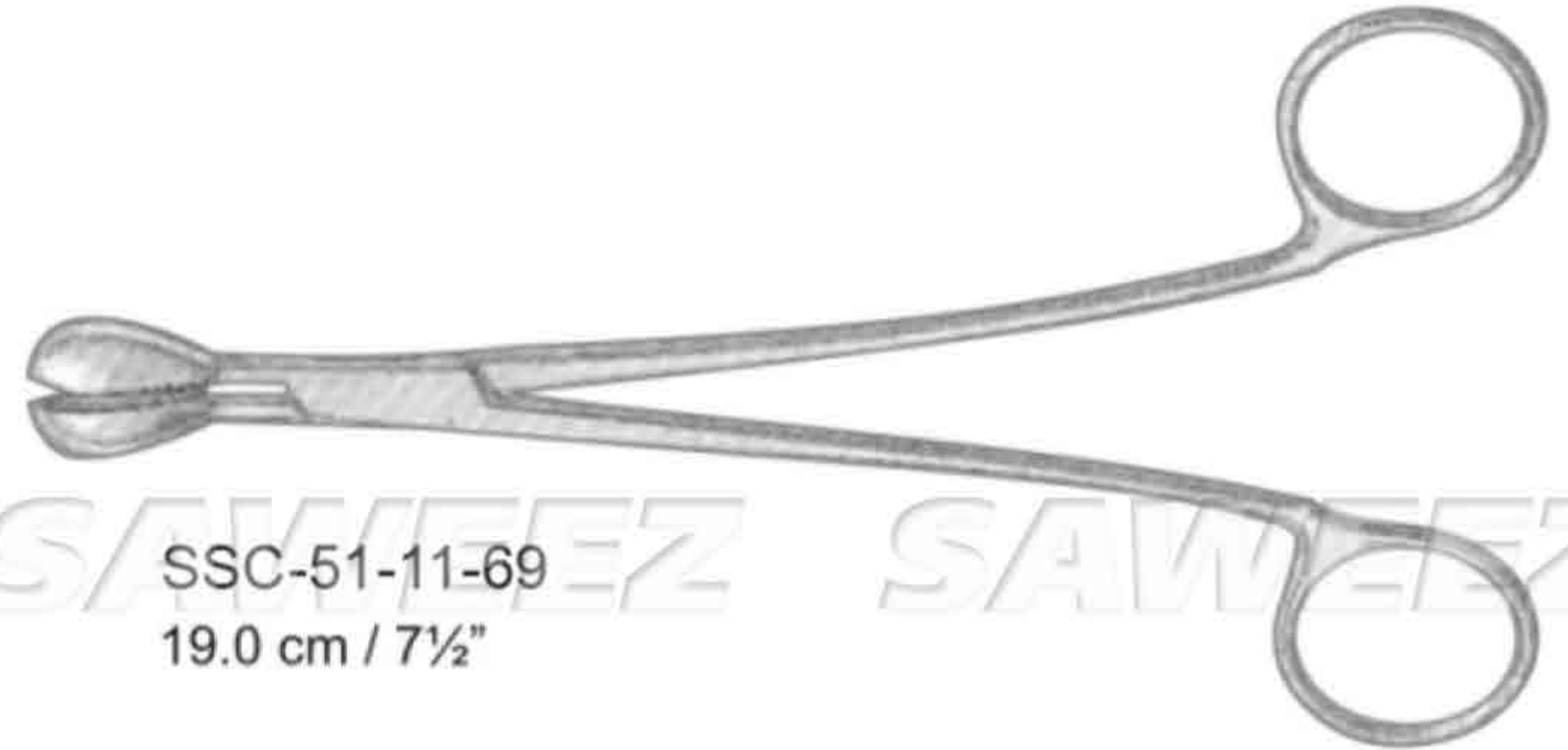


SSC-51-11-68
Roto-Lok,
5mm, 32cm



Stone Extractor

To facilitate stone removal once neck of gallbladder has been externalized.

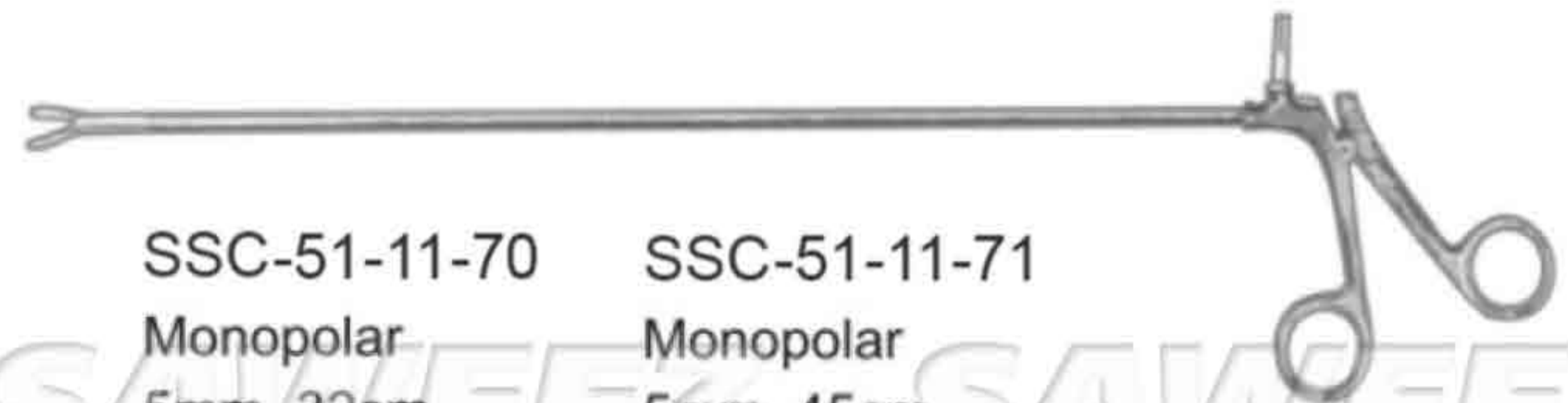


SSC-51-11-69
19.0 cm / 7½"



Stone Extractor

Fenestrated, serrated, oval-shaped jaws that converge at distal end to prevent slippage, double action.



SSC-51-11-70
Monopolar
5mm, 32cm

SSC-51-11-71
Monopolar
5mm, 45cm



Strong Atraumatic Grasping Forceps

Fenestrated, serrated, curved jaws with split-steel construction, for fixation of ovary or manipulation of pelvic tissues.

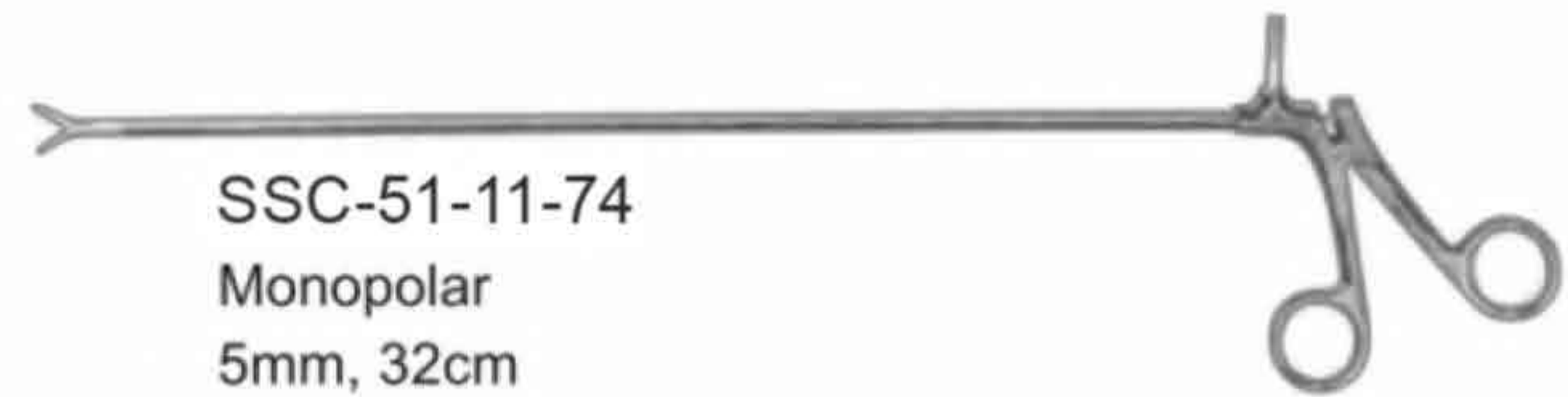


SSC-51-11-72
Spring handle
5mm, 32cm

SSC-51-11-73
Spring handle
5mm, 45cm

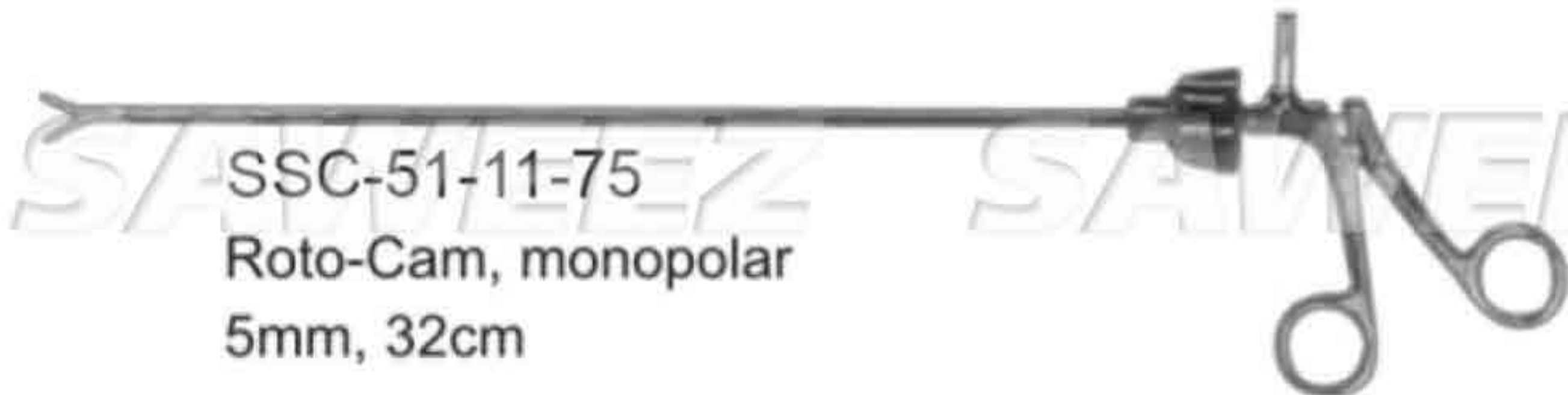
**Micro Dissecting Forceps**

Delicate, fenestrated, serrated jaws for gentle blunt dissection, double action.



SSC-51-11-74

Monopolar
5mm, 32cm

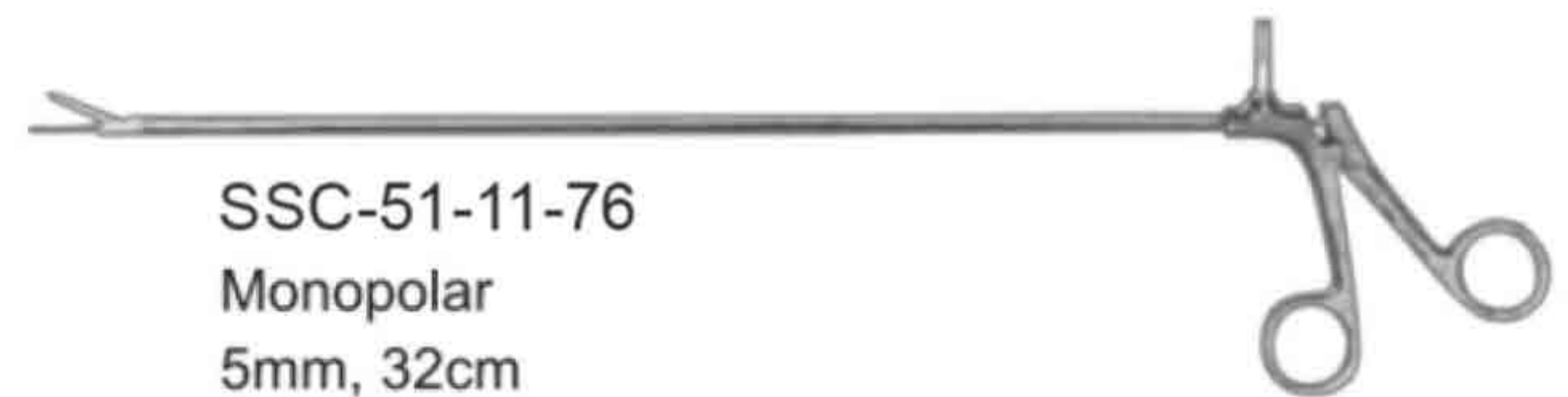


SSC-51-11-75

Roto-Cam, monopolar
5mm, 32cm

**Needle Nose Forceps**

Slender, tapered and fine-serrated jaws.



SSC-51-11-76

Monopolar
5mm, 32cm

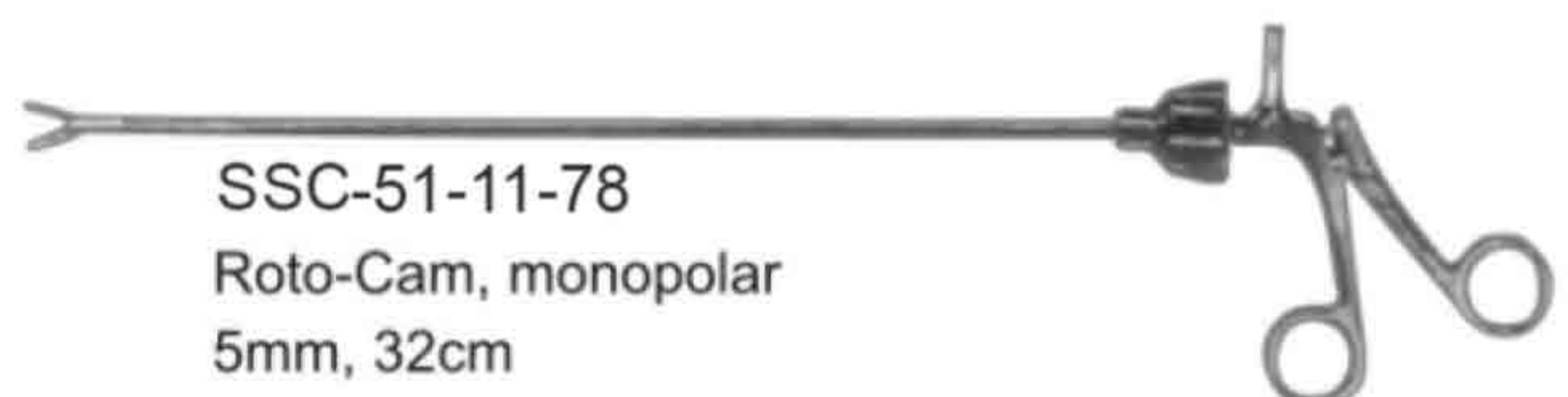
**Tapered Dissecting Forceps**

Tips of serrated, tapered jaws meet at fine point to allow delicate, yet firm, grasp and dissection of thin adventitial tissue, double action.



SSC-51-11-77

Monopolar
5mm, 32cm



SSC-51-11-78

Roto-Cam, monopolar
5mm, 32cm

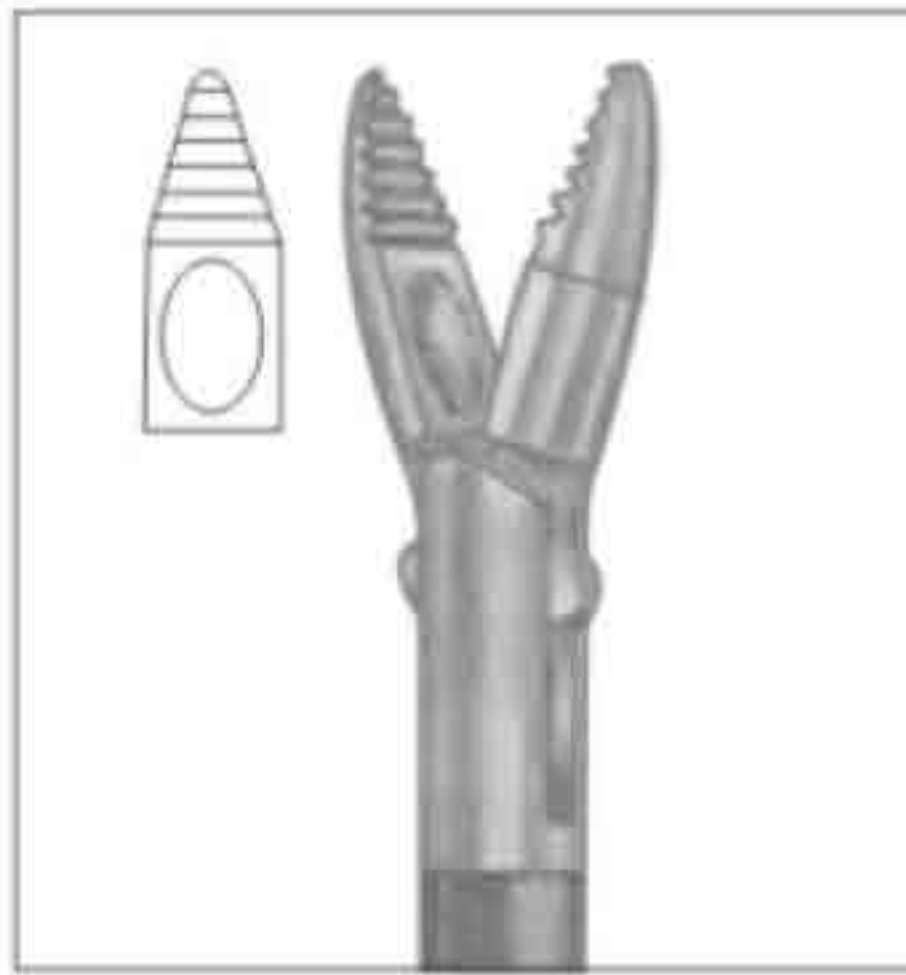
**Micro Grasping Forceps**

3mm small, tapered jaws for dissection of small structures.



SSC-51-11-79

Monopolar
5mm, 32cm



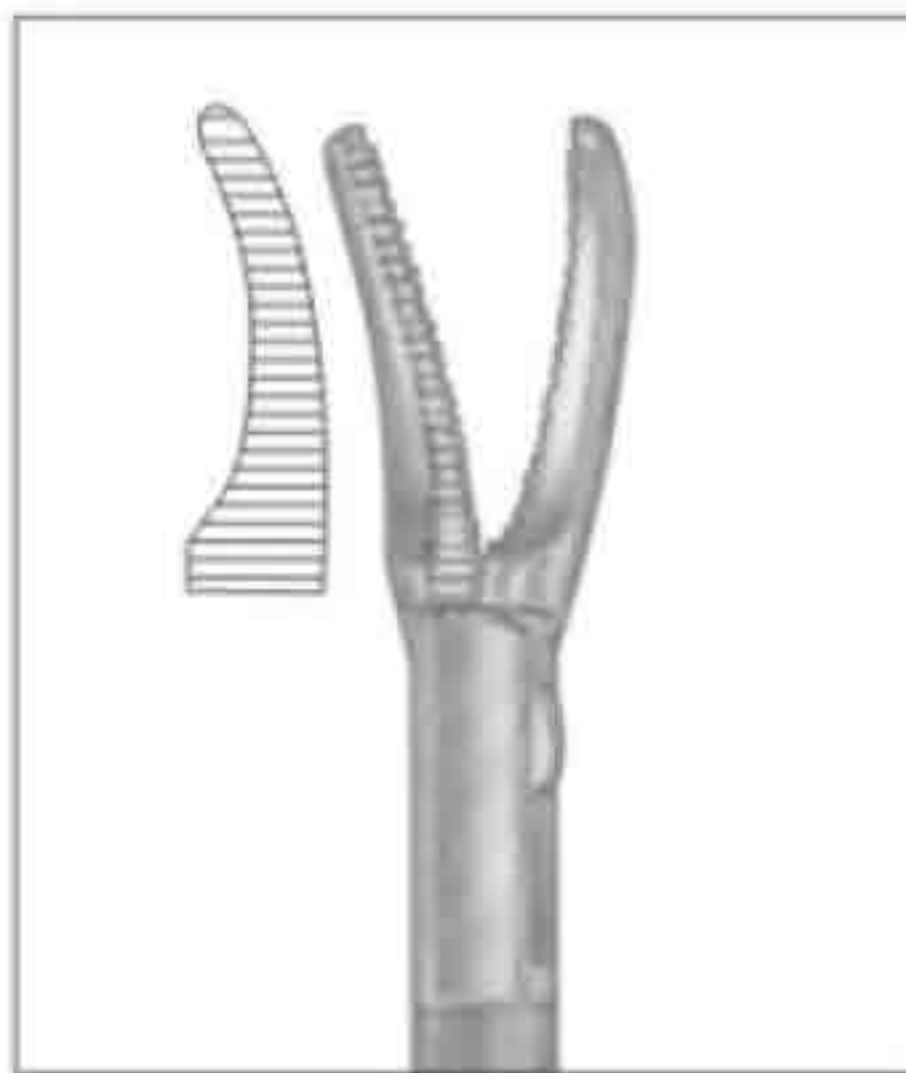
Bullet-Nose Dissecting Forceps

Bullet-shaped, tapered, serrated jaws for dissection, double action.



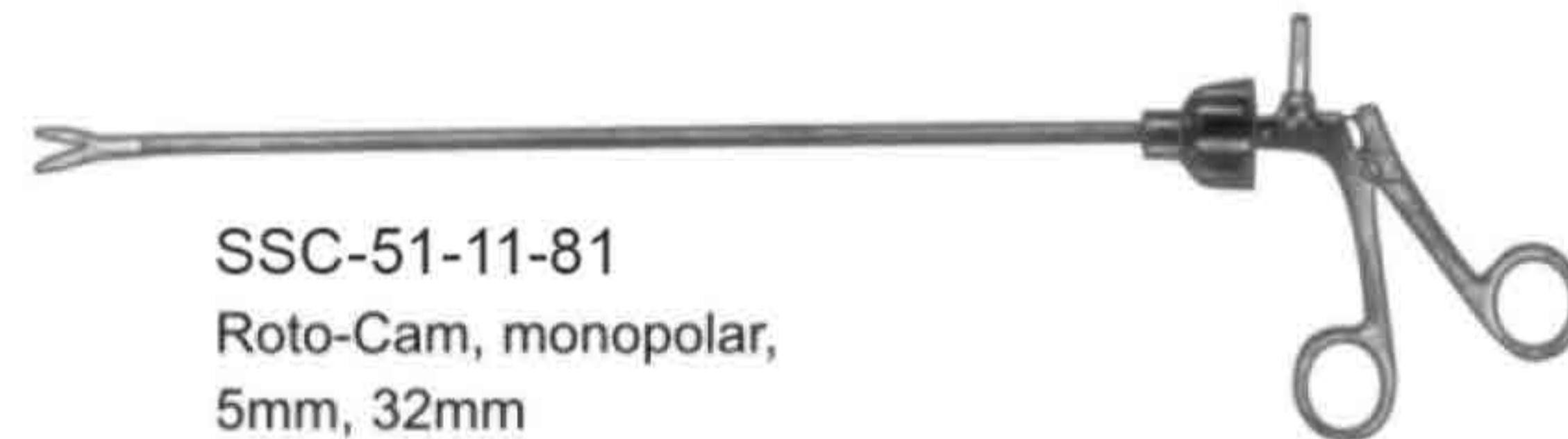
SSC-51-11-80
Roto-Cam, monopolar,
5mm, 32mm

SAWEEZ SAWEEZ SAWEEZ SAWEEZ



Tapered Maryland Dissecting

Curved, finely-tapered, serrated jaws with wide spread, double action.



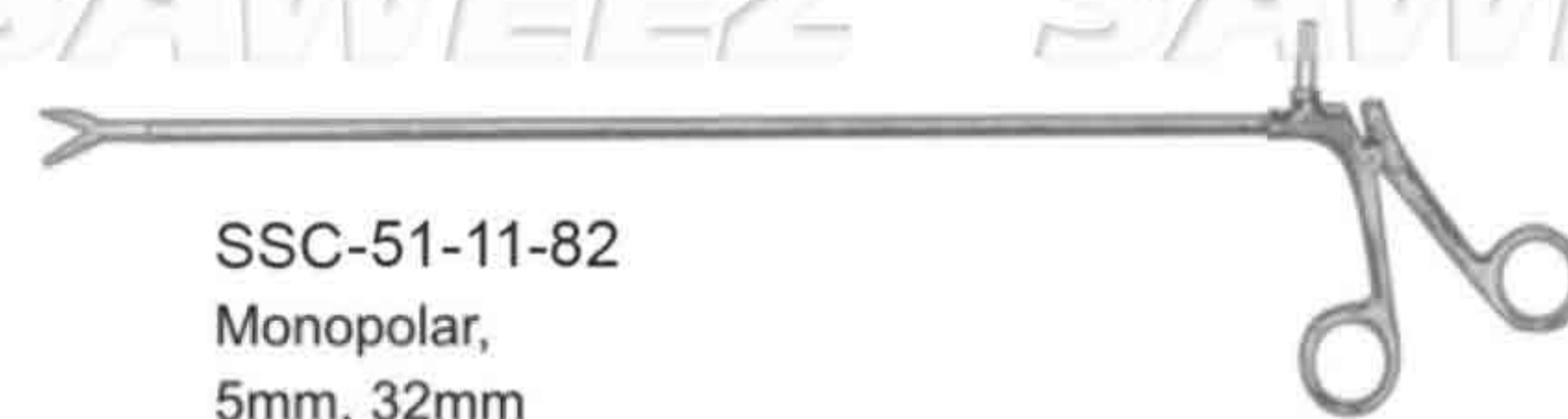
SSC-51-11-81
Roto-Cam, monopolar,
5mm, 32mm

SAWEEZ SAWEEZ SAWEEZ SAWEEZ

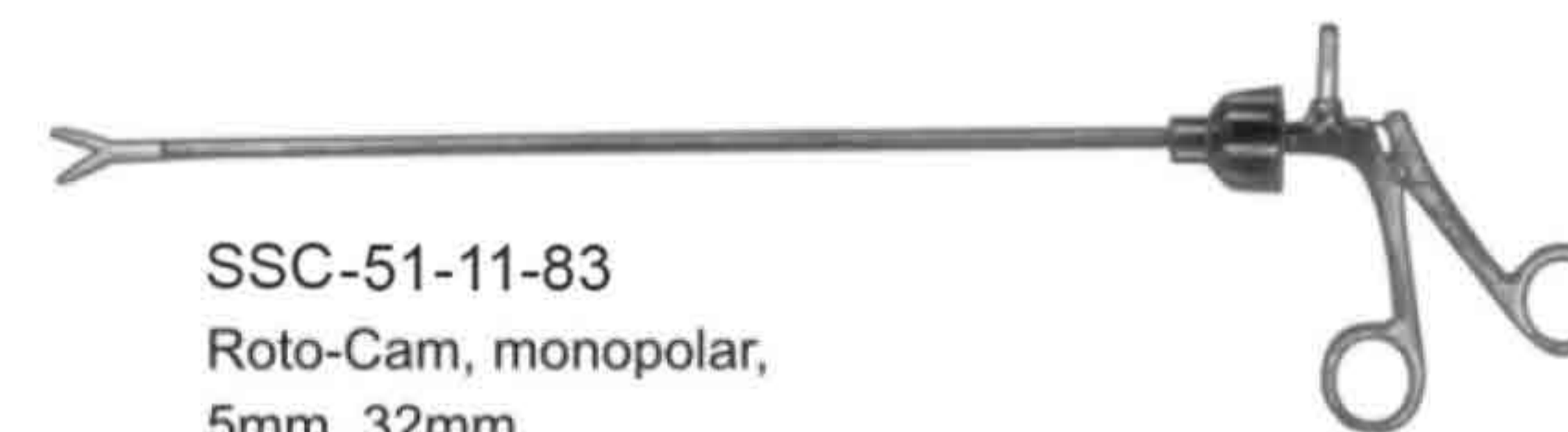


Maryland Dissecting

Curved, tapered, serrated jaws with wide spread, double action.



SSC-51-11-82
Monopolar,
5mm, 32mm



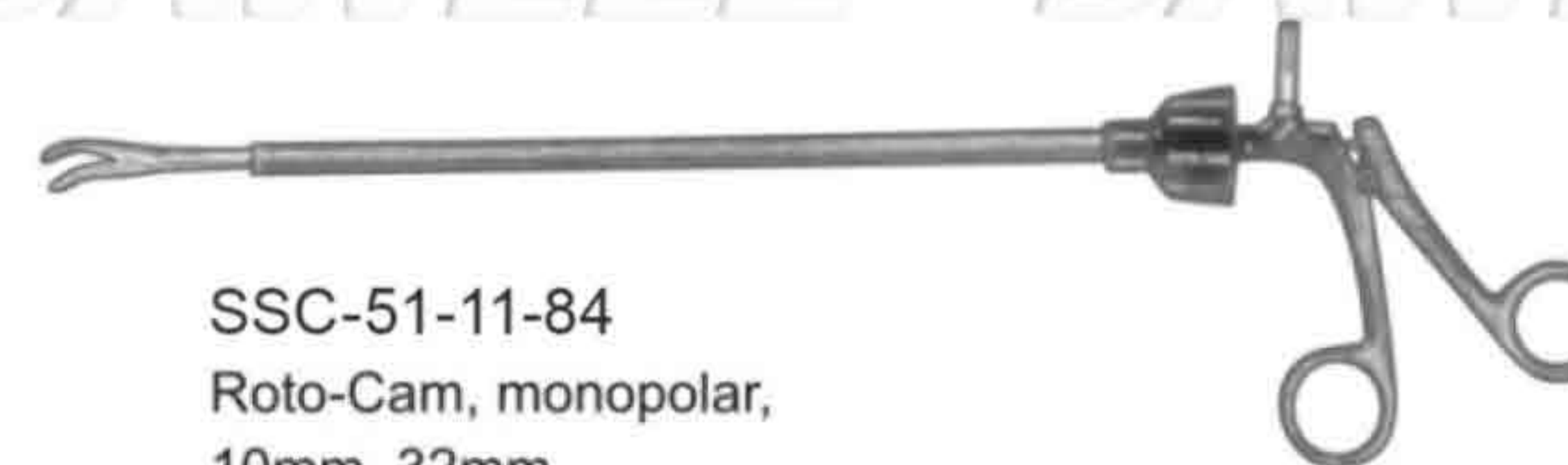
SSC-51-11-83
Roto-Cam, monopolar,
5mm, 32mm

SAWEEZ SAWEEZ SAWEEZ SAWEEZ



Maryland Dissector

Stender, full-curved, long serrated jaws with wide spread, double action.



SSC-51-11-84
Roto-Cam, monopolar,
10mm, 32mm



Mixer Dissecting Forceps

Slender, full-curved, long serrated jaws with wide spread, double action.



SSC-51-11-85
10mm, 32mm

SAWEEZ SAWEEZ SAWEEZ SAWEEZ

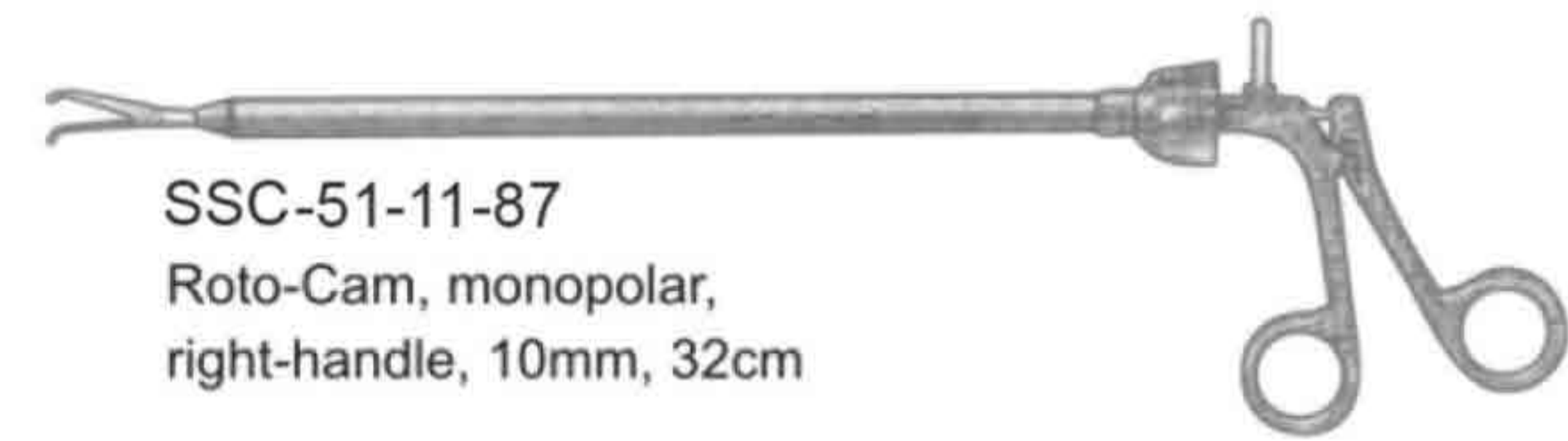


Mixer Spreader-Dissectors

Jaws design offers a true right-angle for dissection around delicate structures; double action. The distinctive ergonomic handle minimize hand fatigue while allowing the surgeon fine control for precise dissection.



SSC-51-11-86
Roto-Cam, monopolar
10mm, 28cm



SSC-51-11-87
Roto-Cam, monopolar,
right-handle, 10mm, 32cm

SAWEEZ SAWEEZ SAWEEZ SAWEEZ

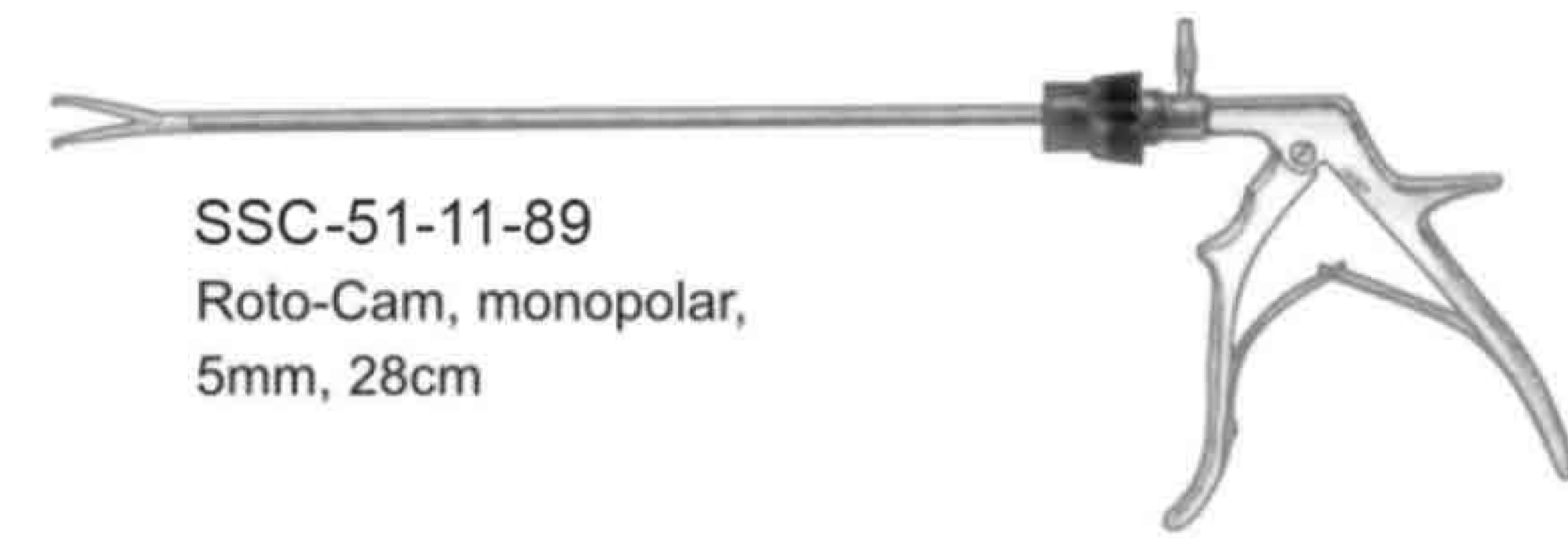


Mixer Spreader-Dissectors

Jaws design offers a true right-angle for dissection around delicate structures; double action. The distinctive ergonomic handle minimize hand fatigue while allowing the surgeon fine control for precise dissection.



SSC-51-11-88
10mm, 28cm



SSC-51-11-89
Roto-Cam, monopolar,
5mm, 28cm



SSC-51-11-90
Roto-Cam, monopolar,
ring-handle, 5mm, 32cm

SAWEEZ SAWEEZ SAWEEZ SAWEEZ

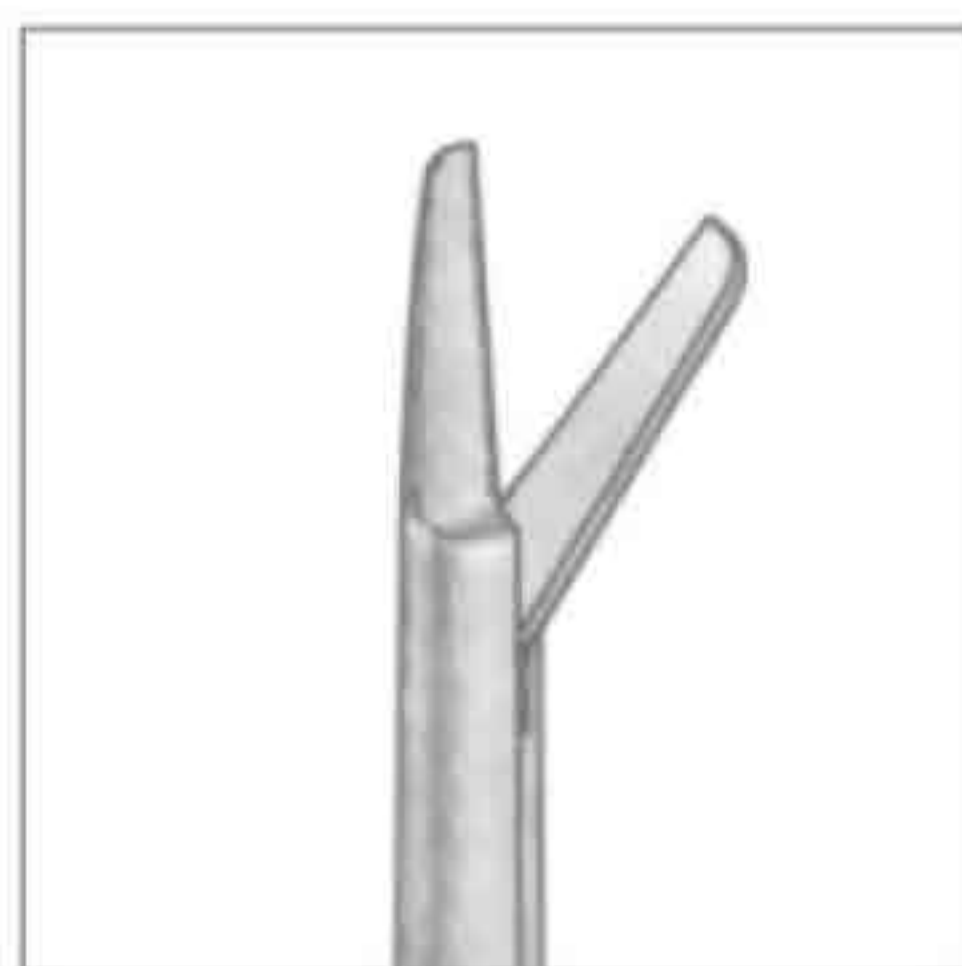


Appel® Spreader-Dissecting Hook

Right-angle tip allows rapid blunt dissection and isolation of structures.



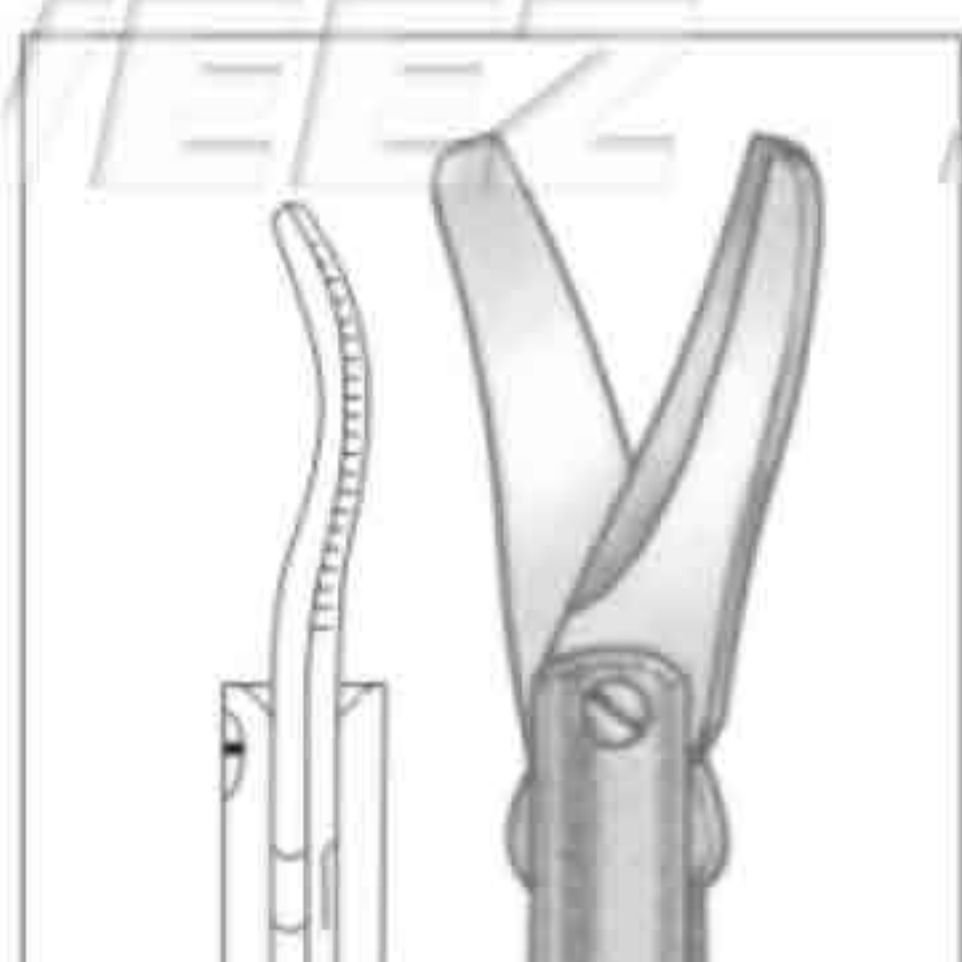
SSC-51-11-91
10mm, 40cm



Supercut Scissors
Razor-sharp upper blade with finely-serrated lower blade allows clean, precise cut without tissue slippage.



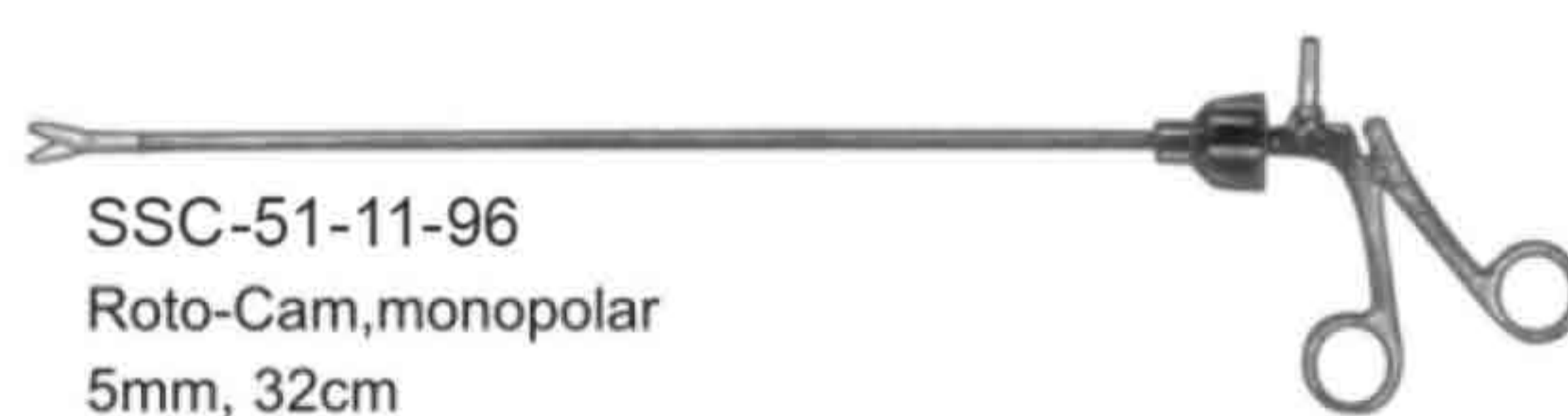
SSC-51-11-92 SSC-51-11-93
5mm, 32cm 5mm, 45cm



Supercut Endo Scissors
Electrosurgical instrument with curved, Supercut blades and precise cutting action offers mechanical cutting, electro-surgical cutting, blunt dissection, electro-surgical coagulation- all in one reusable, cost-effective instrument; double action.



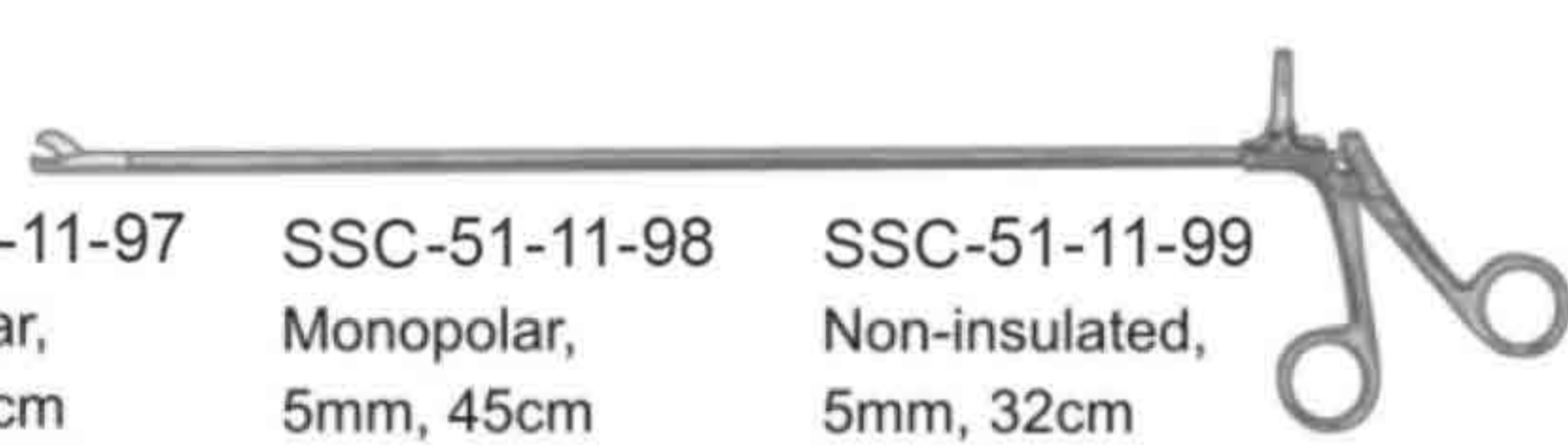
SSC-51-11-94 SSC-51-11-95
Monopolar Monopolar
5mm, 32cm 5mm, 45cm



SSC-51-11-96
Roto-Cam, monopolar
5mm, 32cm



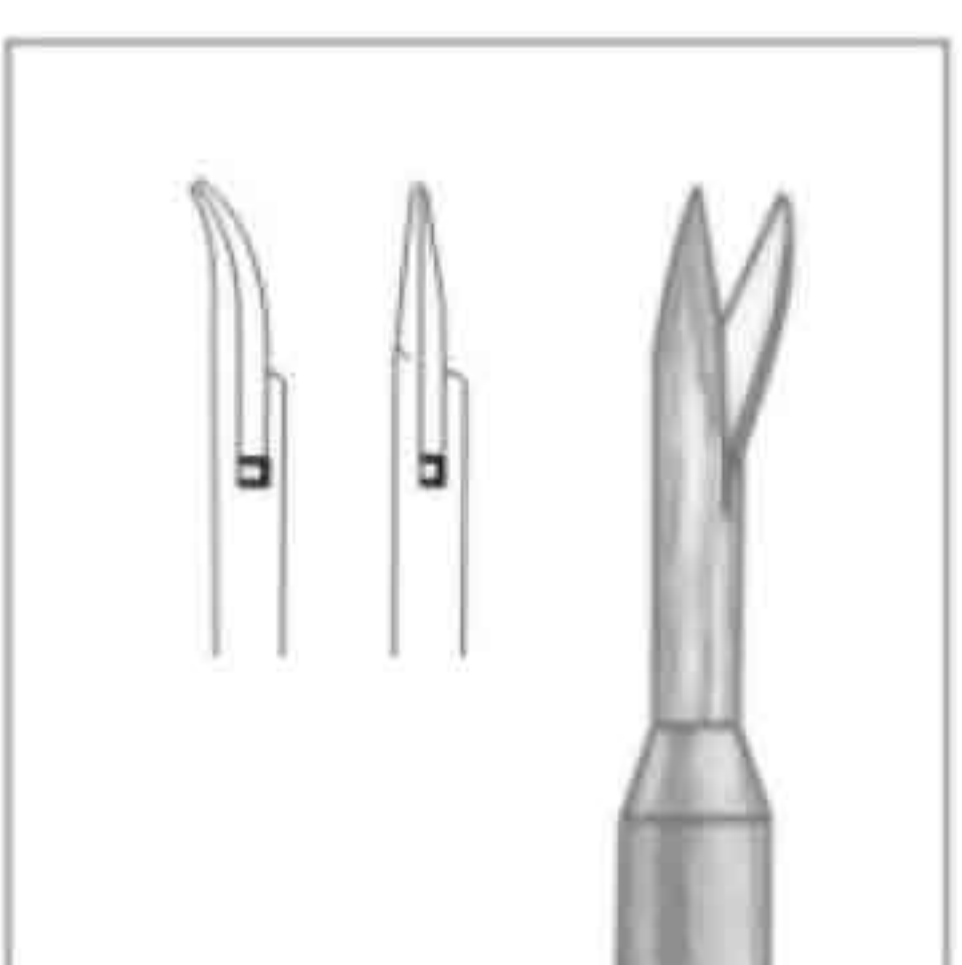
Hook Scissors
Blades designed to lift, isolate and transect tissue.



SSC-51-11-97 SSC-51-11-98 SSC-51-11-99
Monopolar, Monopolar, Non-insulated,
5mm, 32cm 5mm, 45cm 5mm, 32cm



SSC-51-12-00
Roto-Cam, Monopolar,
5mm, 32cm



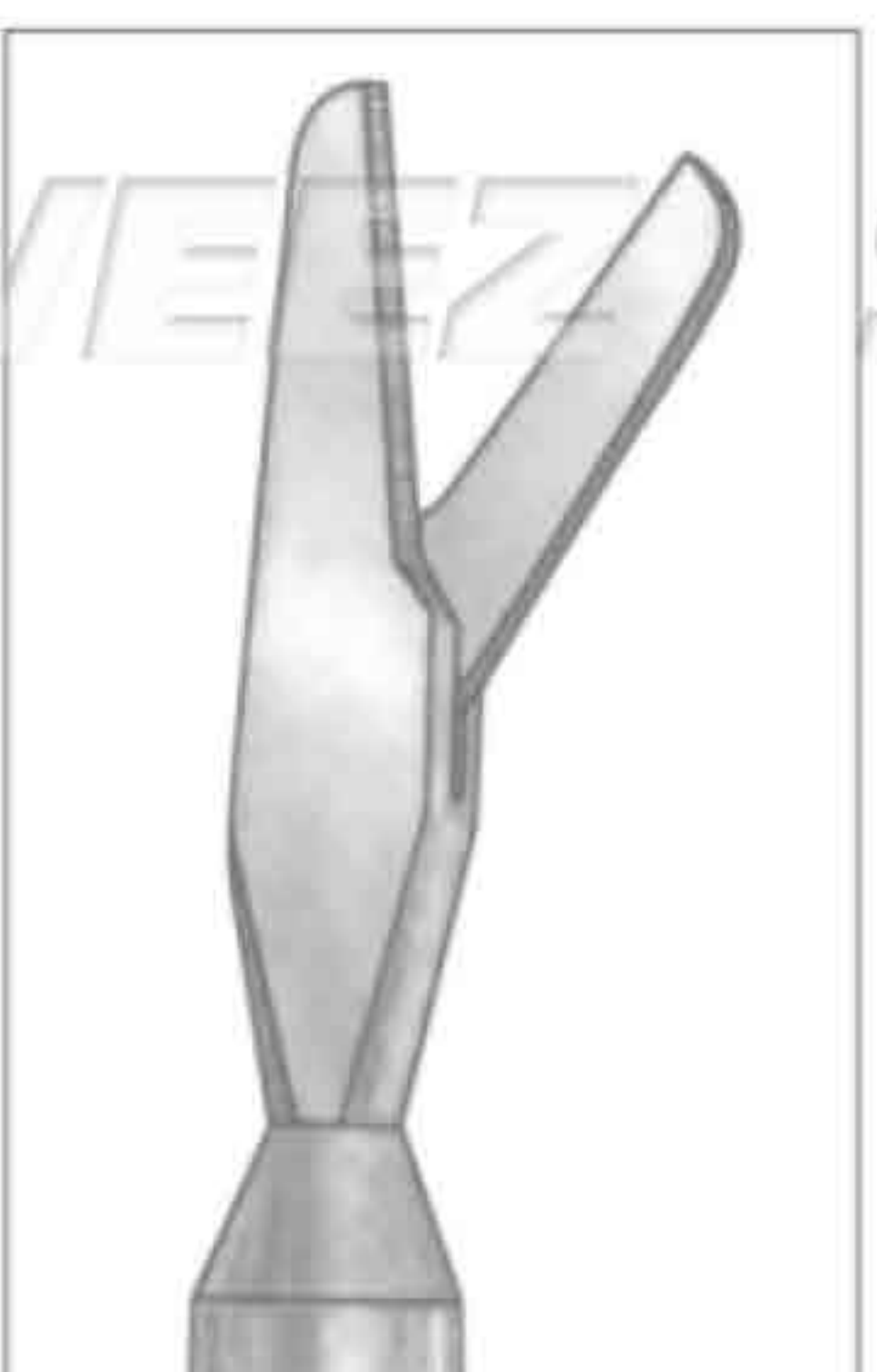
Micro Scissors
Fine, delicate, 3mm blades for small incision.



SSC-51-12-01
Curved Left,
5mm, 32cm



SSC-51-12-02
Straight,
5mm, 32cm



Mayo Operating Scissors
Large, sturdy blades for incising heavy tissue.



SSC-51-12-03
10mm, 32cm

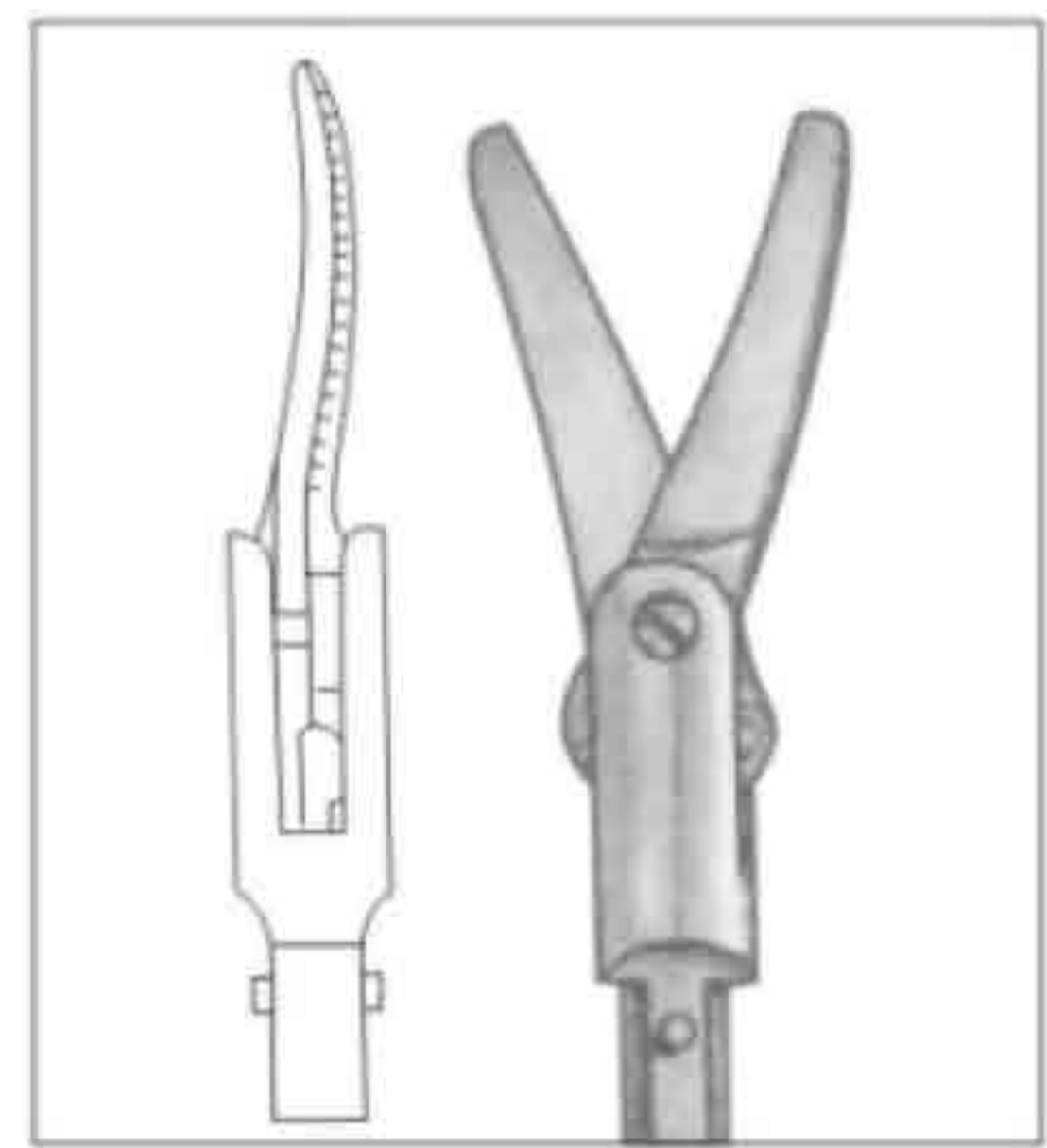


Detach Scissors Insert

SSC-51-12-04
Cleaning brushes, pkg/6

Detach Handle/Shaft

SSC-51-12-05
Roto-Cam, monopolar,
5mm, 32cm



Supercut Detach Scissors

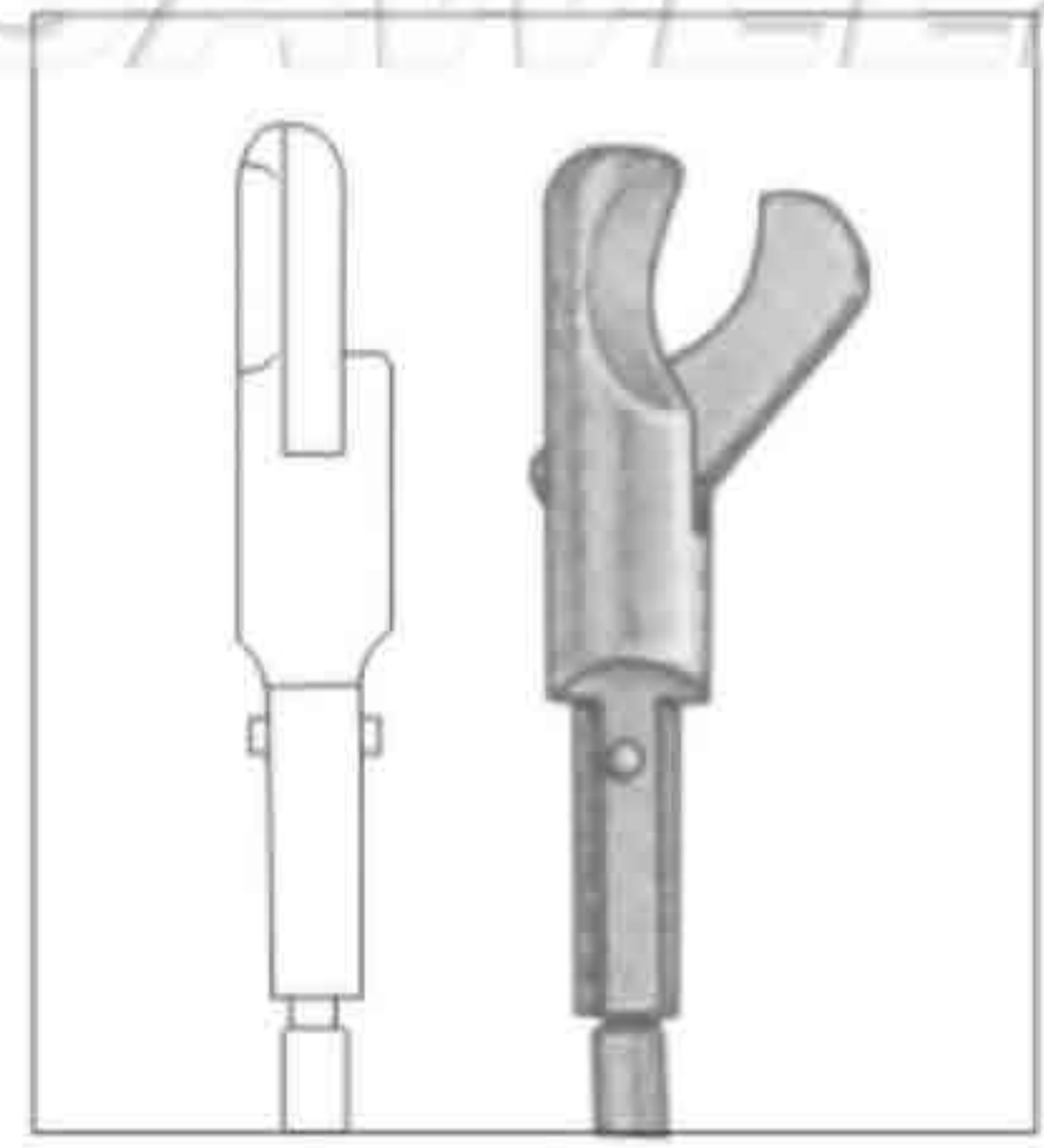
Unique supercut blade has a finely-serrated lower blade that helps prevent tissue slippage, curved blades meet the contour of structures while the blunt-shaped distal tip allows tissue manipulation and cauterization with blades closed, double action.



SSC-51-12-06
Roto-Cam, monopolar,
5mm, 32cm

SSC-51-12-07
Insert 5mm, 32cm

SSC-51-12-08
Insert 5mm, 32cm, pkg/3



Hook Detach Scissors

Classic hook blades designed to lift, isolate and transect tissue.



SSC-51-12-09
Roto-Cam, monopolar,
5mm, 32cm

SSC-51-12-10
Insert 5mm, 32cm

SSC-51-12-11
Insert 5mm, 32cm, pkg/3



Micro Detach Scissors Curved

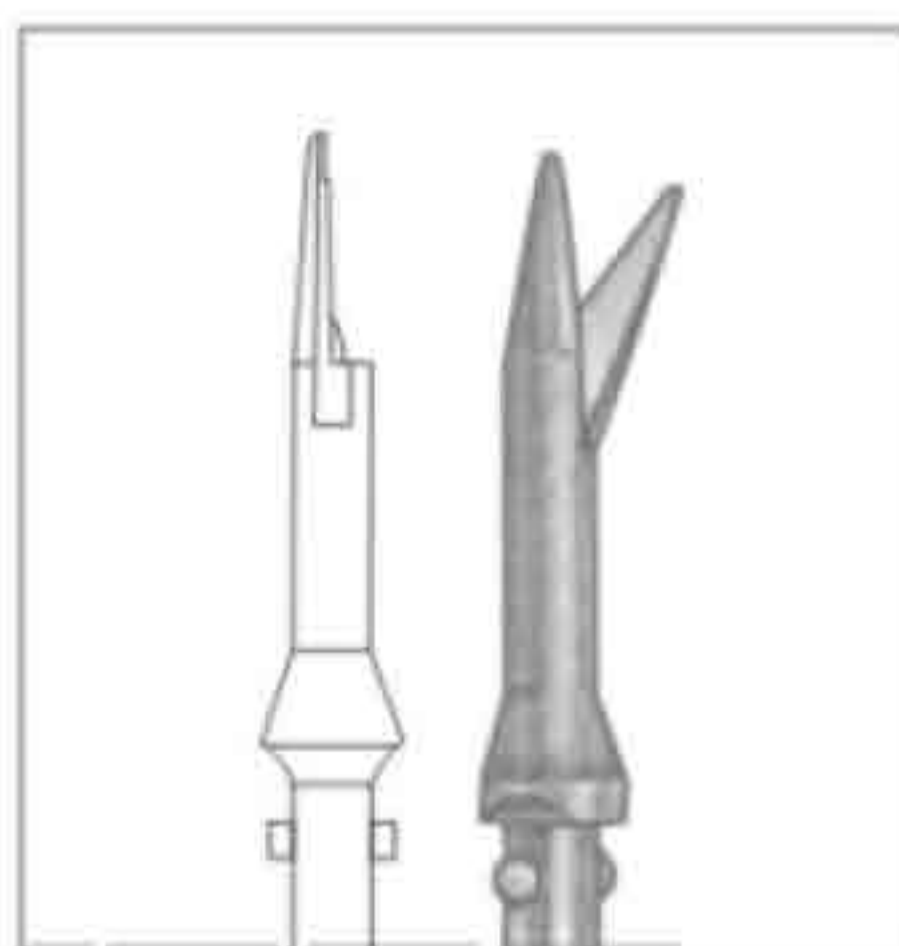
Delicate, sharp-sharp, curved blades.



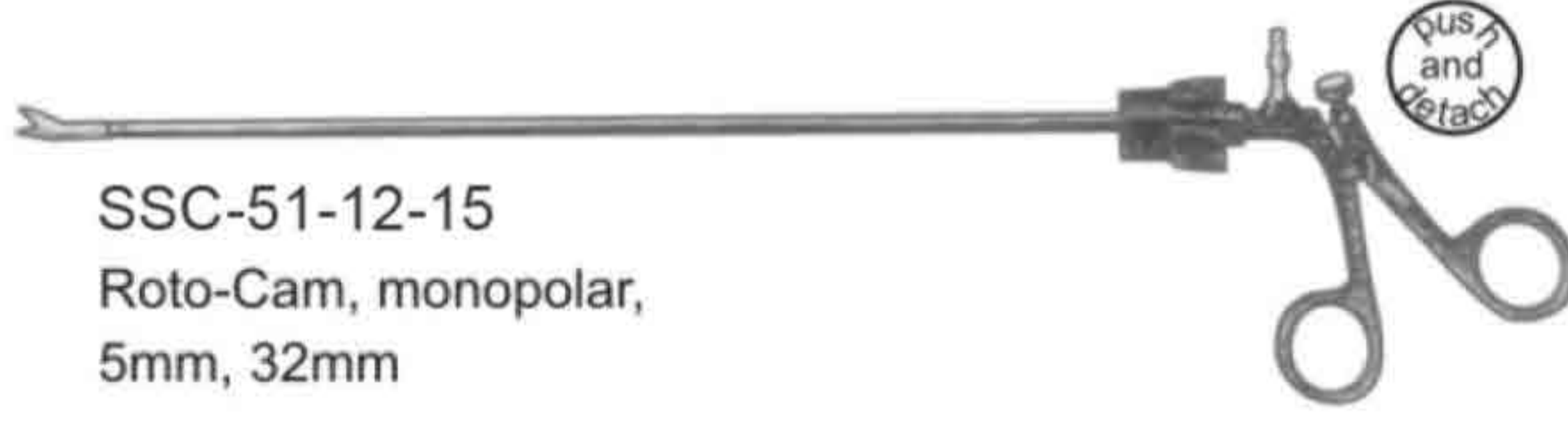
SSC-51-12-12
Roto-Cam, monopolar,
5mm, 32cm

SSC-51-12-13
Insert 5mm, 32cm

SSC-51-12-14
Insert 5mm, 32cm, pkg/3



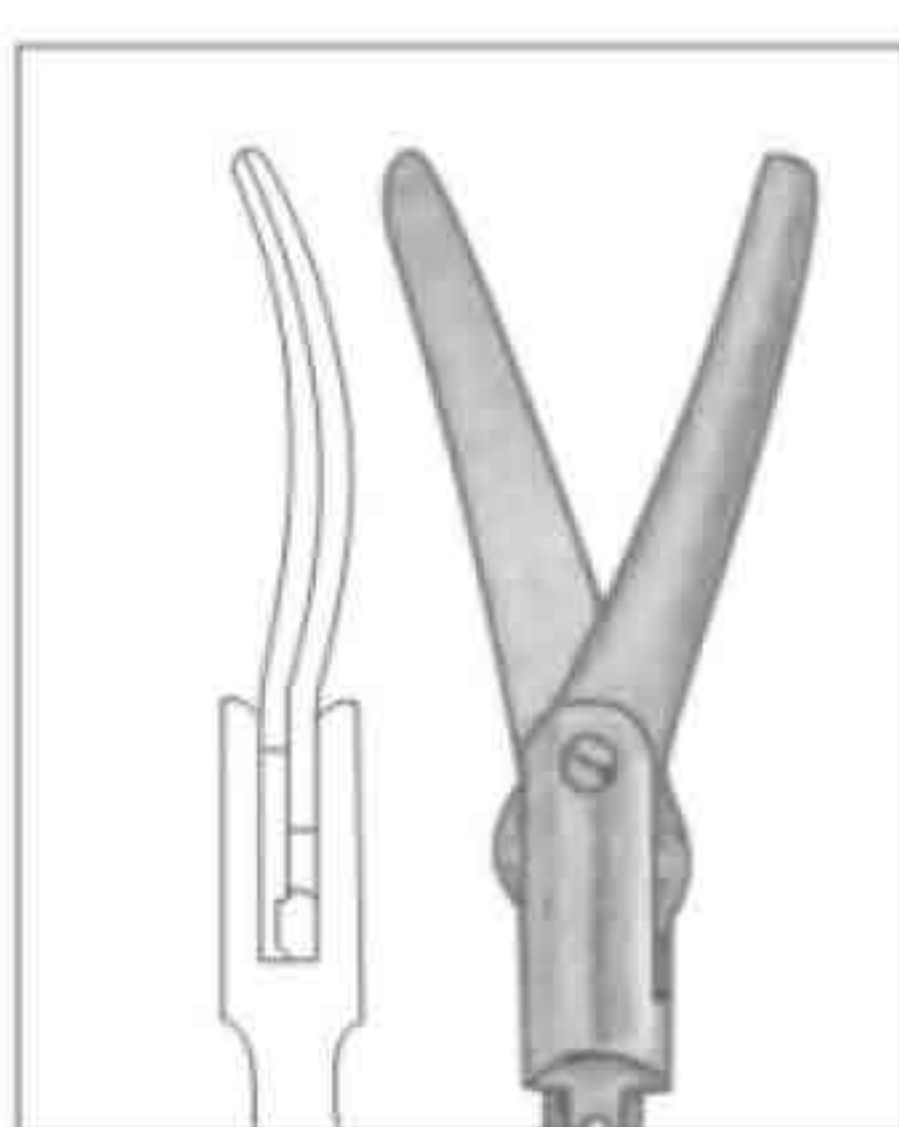
**Micro Detach Scissors
Straight**
Delicate, sharp-sharp,
straight blades



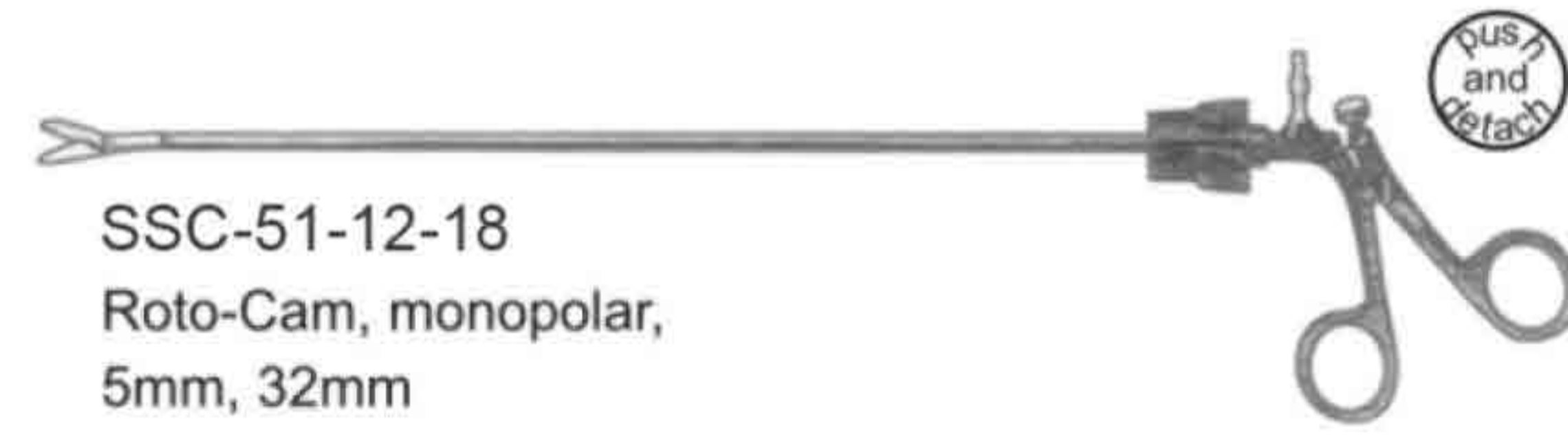
SSC-51-12-15
Roto-Cam, monopolar,
5mm, 32mm

SSC-51-12-16
Insert, 5mm, 32mm

SSC-51-12-17
Insert, 5mm, 32mm, plg/3



Metzenbaum Detach Scissors
Long, curved, tapered
blades with wide spread,
double action



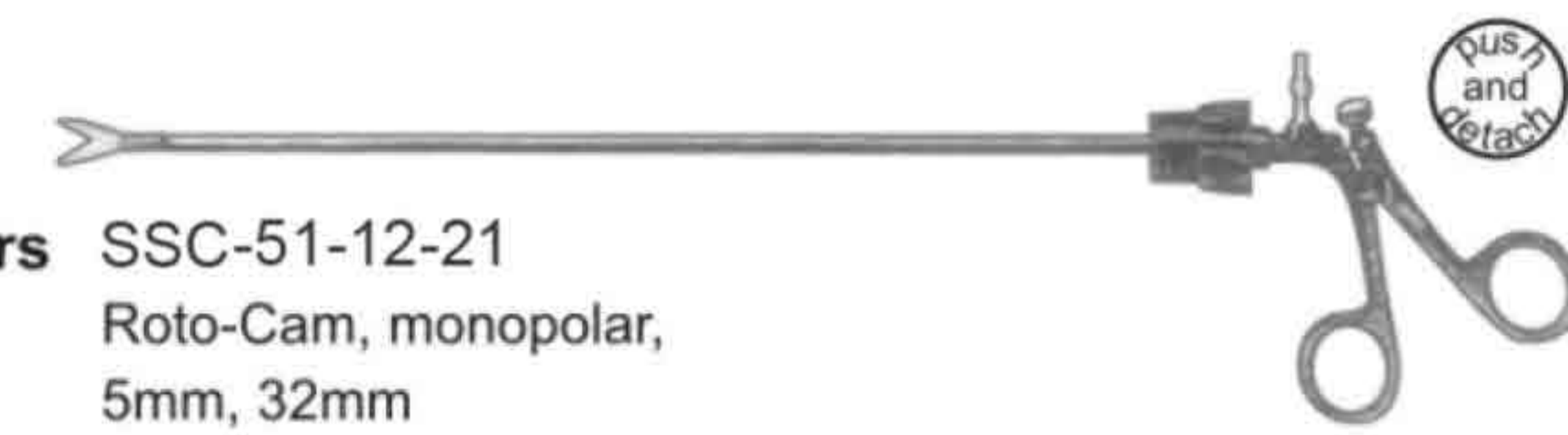
SSC-51-12-18
Roto-Cam, monopolar,
5mm, 32mm

SSC-51-12-19
Insert, 5mm, 32mm

SSC-51-12-20
Insert, 5mm, 32mm, plg/3



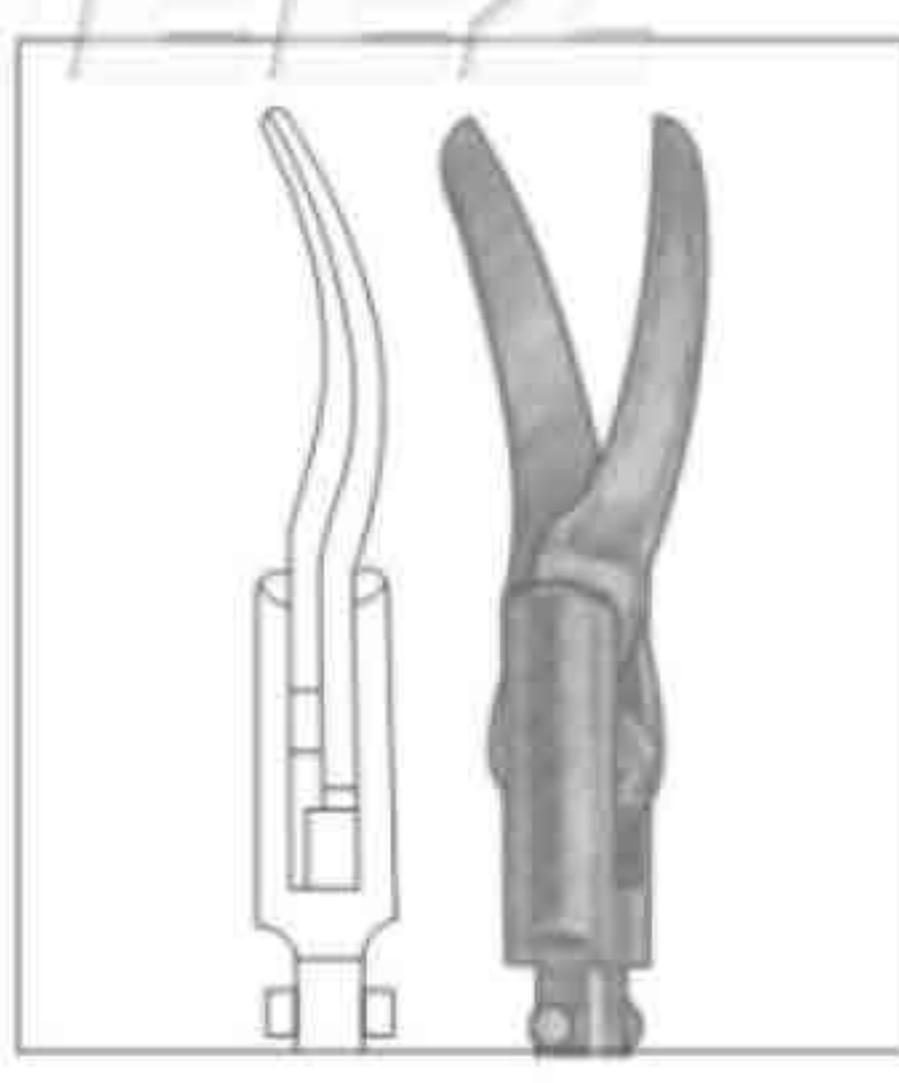
"Baby" Metzenbaum Detach Scissors
Shorter, curved, very tapered
blades reach more narrow
and delicate dissection
areas, double action



SSC-51-12-21
Roto-Cam, monopolar,
5mm, 32mm

SSC-51-12-22
Insert, 5mm, 32mm

SSC-51-12-23
Insert, 5mm, 32mm, plg/3



Mini Detach Scissors
Curved, tapered, delicate
blades, double action



SSC-51-12-24
Roto-Cam, monopolar,
5mm, 32mm

SSC-51-12-25
Insert, 5mm, 32mm

SSC-51-12-26
Insert, 5mm, 32mm, plg/3



Biopsy Forceps

Two sharp teeth, one on each jaw, for biopsy or secure hold of thick-walled tissue.



SSC-51-12-27	SSC-51-12-28
1x1 teeth, spring-loaded, 5mm, 32mm	1x1 teeth, spring-loaded, 5mm, 45mm

SAWEEZ SAWEEZ SAWEEZ SAWEEZ



Biopsy Punches

Serrated lower jaw.



SSC-51-12-29	SSC-51-12-30
Monopolar, 5mm, 32mm	Monopolar, 5mm, 45mm



Hook Biopsy Punches

Frangenheim-type electro-surgical biopsy punch with hook blade.



SSC-51-12-31	SSC-51-12-32
Monopolar, 5mm, 32mm	Monopolar, 5mm, 45mm

SAWEEZ SAWEEZ SAWEEZ SAWEEZ



Biopsy Punches

Single tooth in upper jaw.



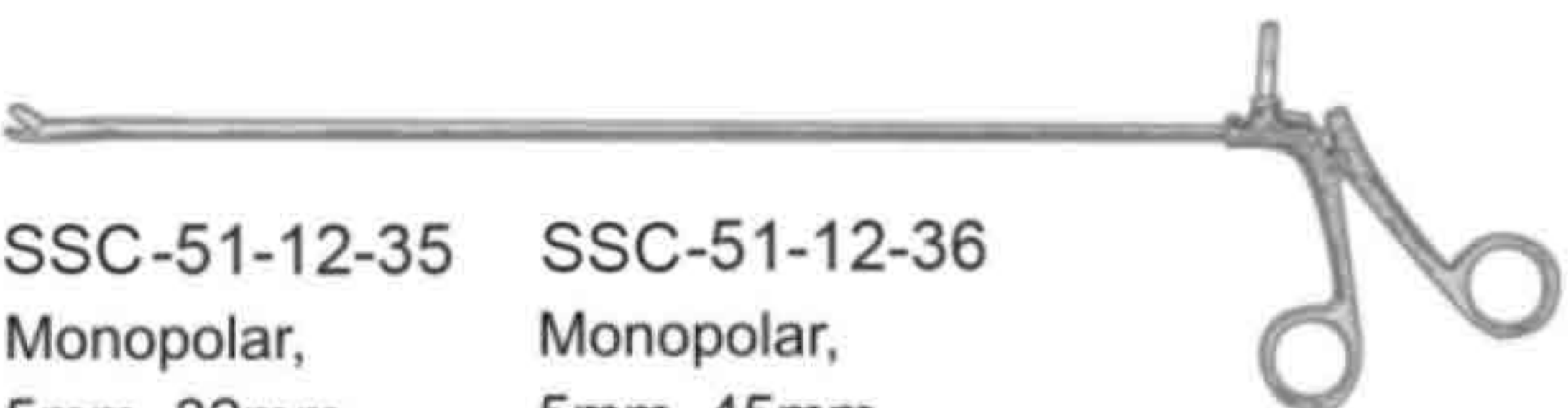
SSC-51-12-33	SSC-51-12-34
Monopolar, 5mm, 32mm	Monopolar, 5mm, 45mm

SAWEEZ SAWEEZ SAWEEZ SAWEEZ

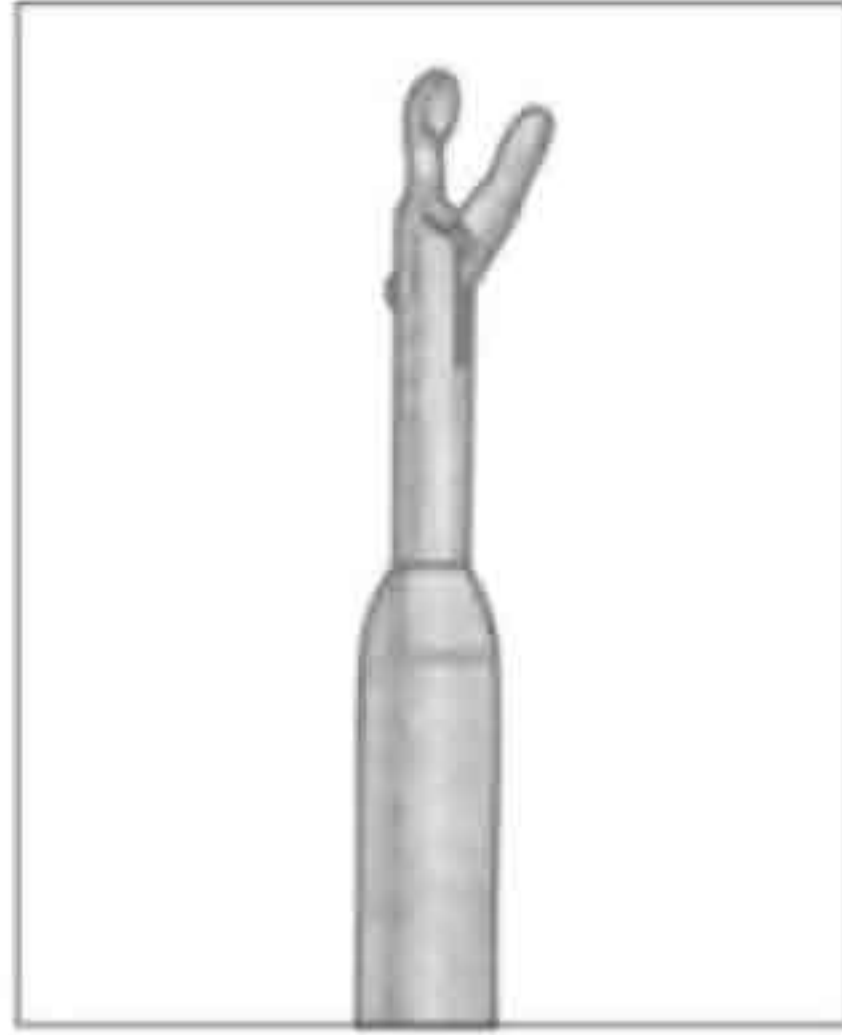


Biopsy Forceps

Oval-shaped fenestrated jaws.



SSC-51-12-35	SSC-51-12-36
Monopolar, 5mm, 32mm	Monopolar, 5mm, 45mm

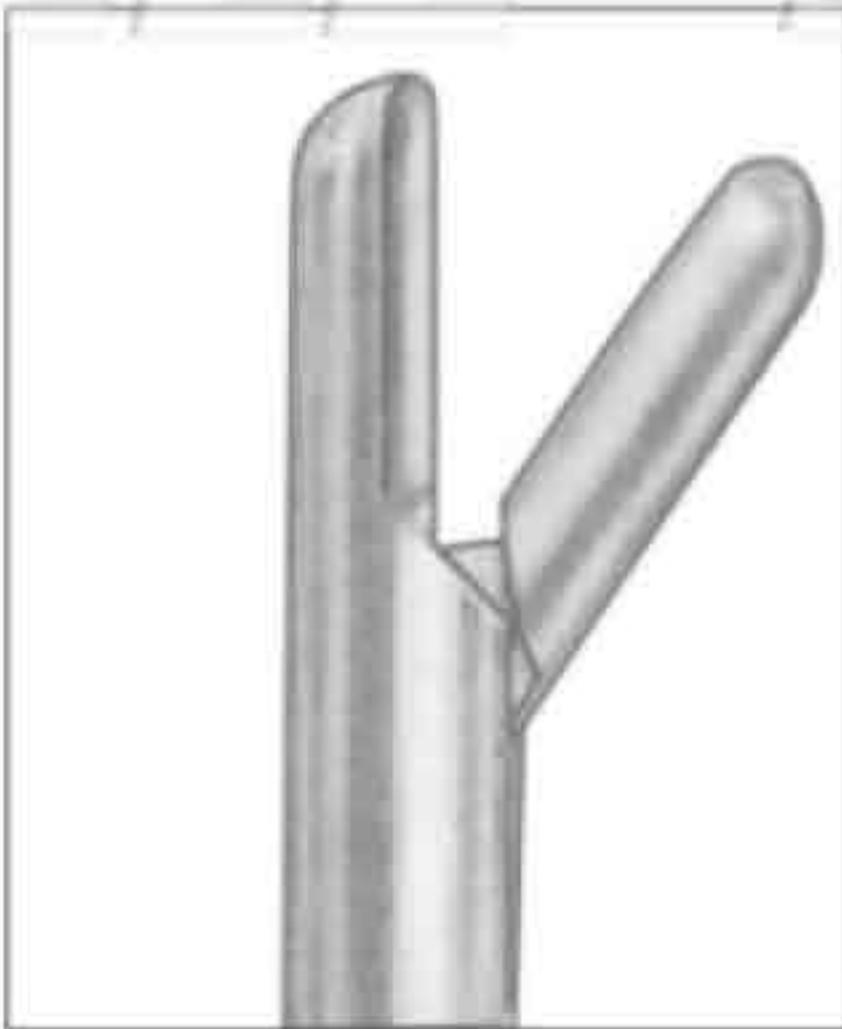
**Micro Biopsy Forceps**

3mm jaws for biopsy of small, delicate tissues.



SSC-51-12-37
Spring-loaded,
5mm, 32cm

SAWEEZ SAWEEZ SAWEEZ SAWEEZ

**Spoon Forceps**

Wide cup-shaped jaws for tissue or stone removal.



SSC-51-12-38
Spring-loaded,
5mm, 32cm

**Cholangiogram Clamp**

Channel for placement of 5Fr or smaller cholangiogram catheter.



SSC-51-12-39
Ratchet,
5mm, 32cm

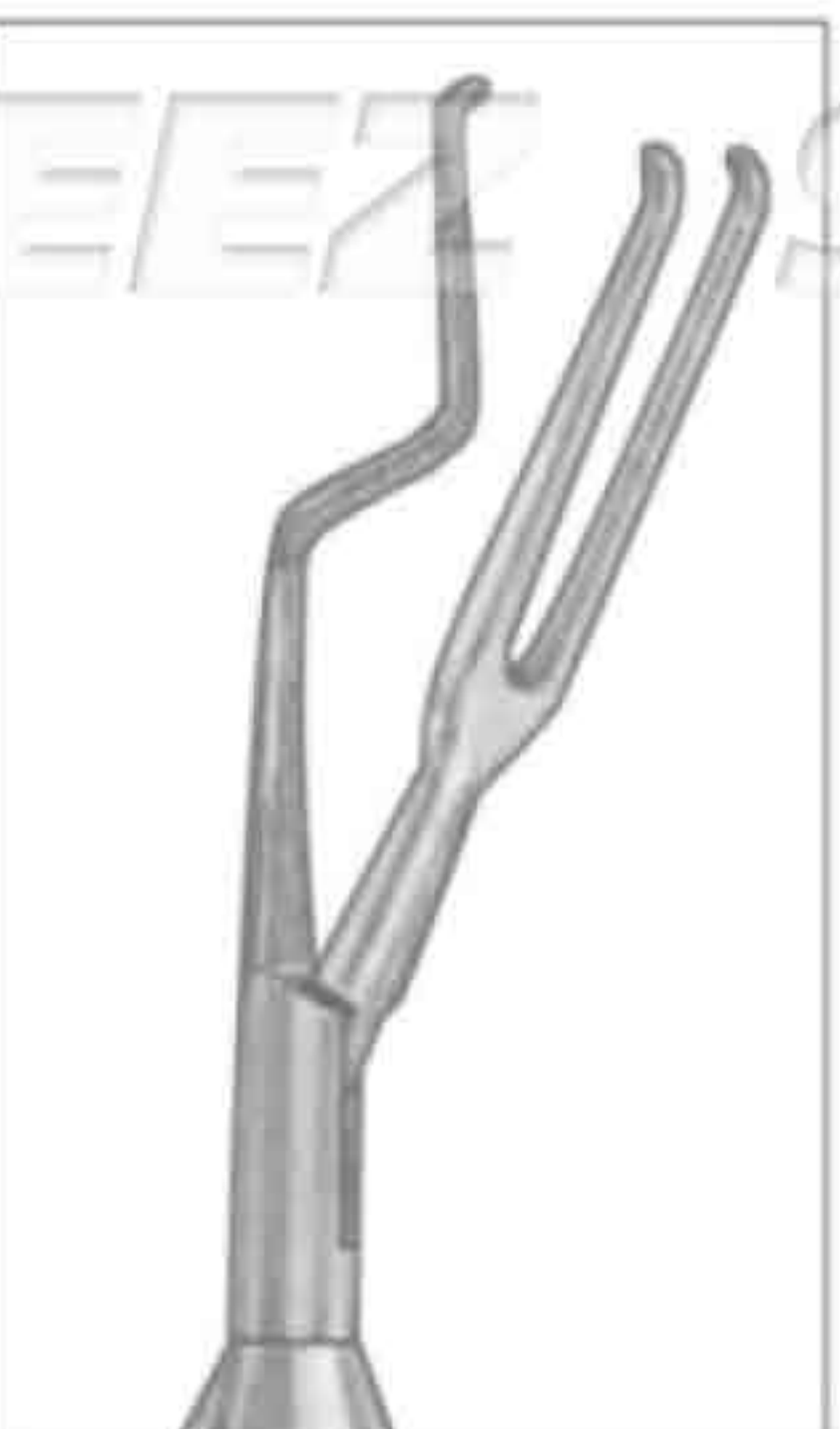
SAWEEZ SAWEEZ SAWEEZ SAWEEZ

**Cholangiogram Guide**

Curved tip for simple placement of cholangiogram catheter.



SSC-51-12-40
5mm, 32cm

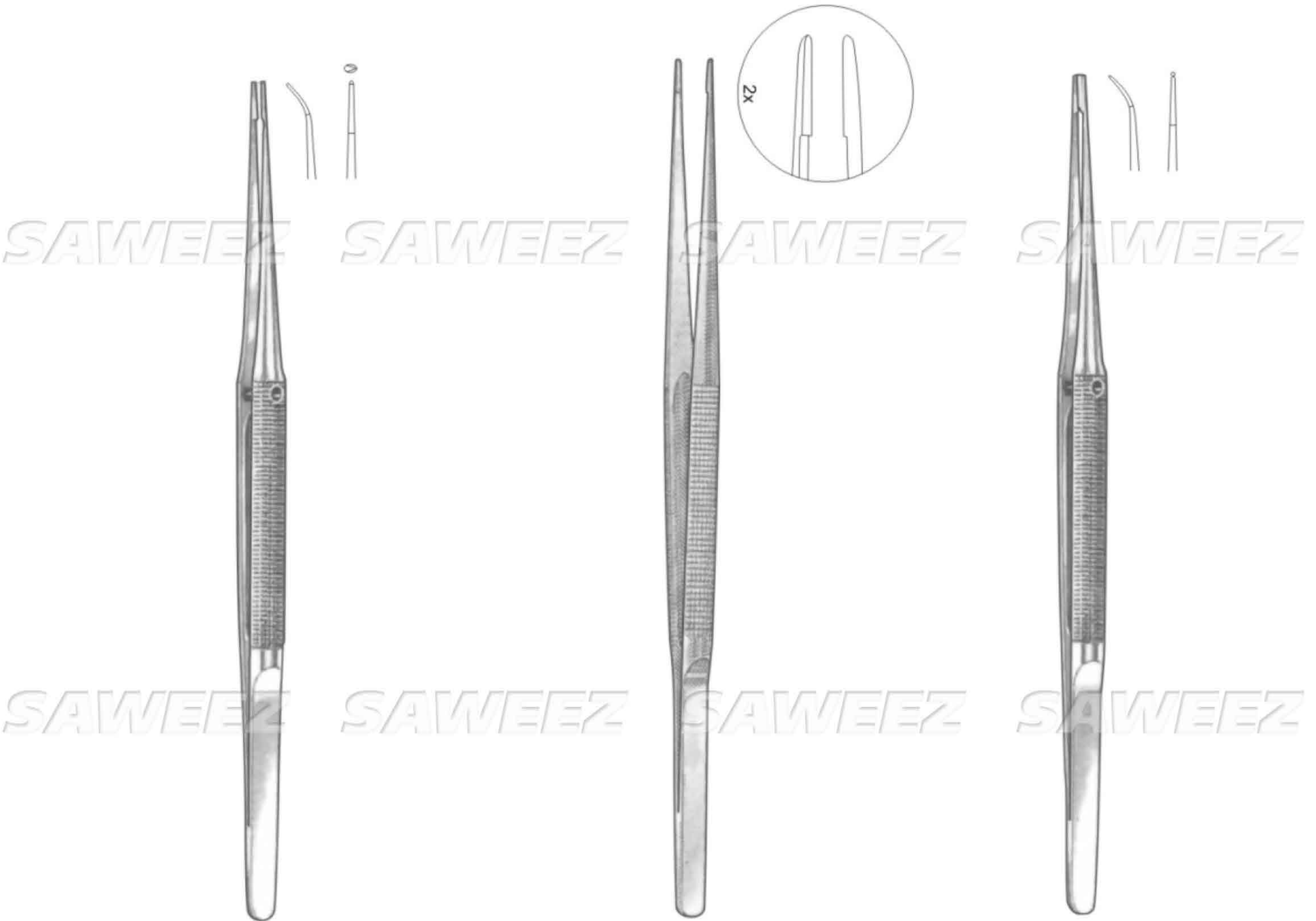
**Bessler/Treat Suture Forceps**

Uniquely designed jaws allow easier grasp and positioning tubular structure for placement of pursue string with straight of curved needle.



SSC-51-12-41
5mm, 32cm

SAWEEZ SAWEEZ SAWEEZ SAWEEZ



Microsurgical Forceps

with platform, round handle, 18.0cm / 7"

- SSC-53-11-11 - Curved 0.4mm micro tip
- SSC-53-11-12 - Curved 0.5mm micro tip ½ teeth
- SSC-53-11-13 - Curved 0.8mm delicate tip
- SSC-53-11-14 - Curved 0.8 delicate tip 1 x 2
- SSC-53-11-15 - Straight 0.4mm micro tip
- SSC-53-11-16 - Straight 0.5mm micro tip 1 x 2 teeth
- SSC-53-11-17 - Straight 0.8mm delicate tip
- SSC-53-11-18 - Straight 0.8mm delicate tip 1 x 2 teeth

Rhoton Type Suture Tying Forceps

SSC-53-11-19

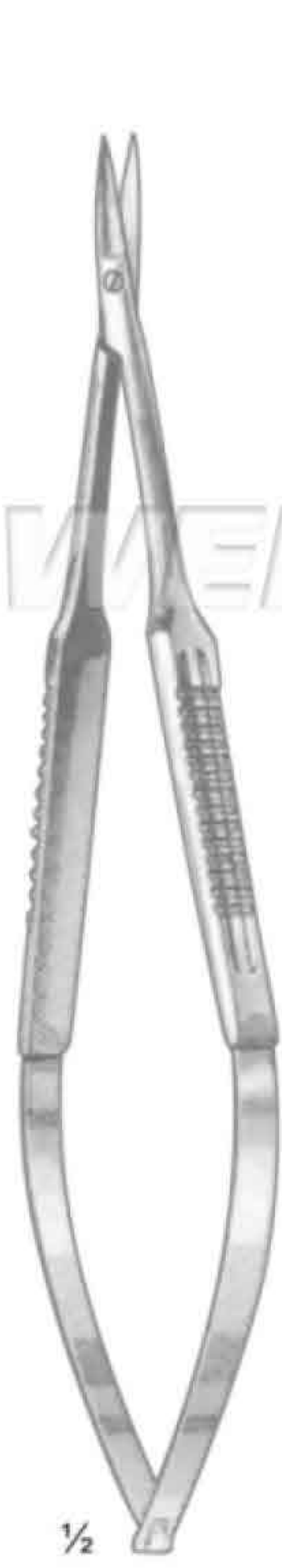
with platform, round handle.

18.0cm / 7" Straight

Micro Suture Tying Forceps

with platform, round handle,
15.0cm / 6"

- SSC-53-11-20 Curved
- SSC-53-11-21 Straight



SSC-53-11-22 serrated



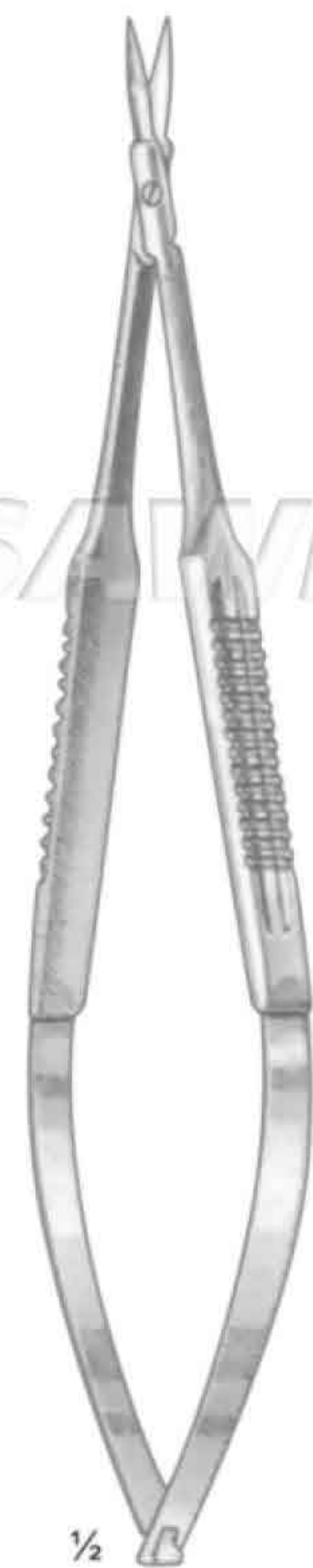
SSC-53-11-23



SSC
SSC-53-11-24 serrated



SSC-53-11-25



SSC-53-11-26



SSC-53-11-27

Microsurgical Scissors
Wide handle, 15.0cm / 6"
regular blade

Microsurgical Scissors
Wide handle, 15.0cm / 6"
micro blade



SSC-53-11-28



SSC-53-11-29



SSC-53-11-30
angle to side, 60°

Microsurgical Scissors
Round handle, 18.0cm / 7"
regular blade



SSC-53-11-31



SSC-53-11-32



Microsurgical Scissors
Round handle, bayonet
shape, 21.0cm / 8 1/4"
regular blade

SAWEEZ SAWEEZ SAWEEZ SAWEEZ



Microsurgical Needle Holders
round handle, 15.0cm / 6"

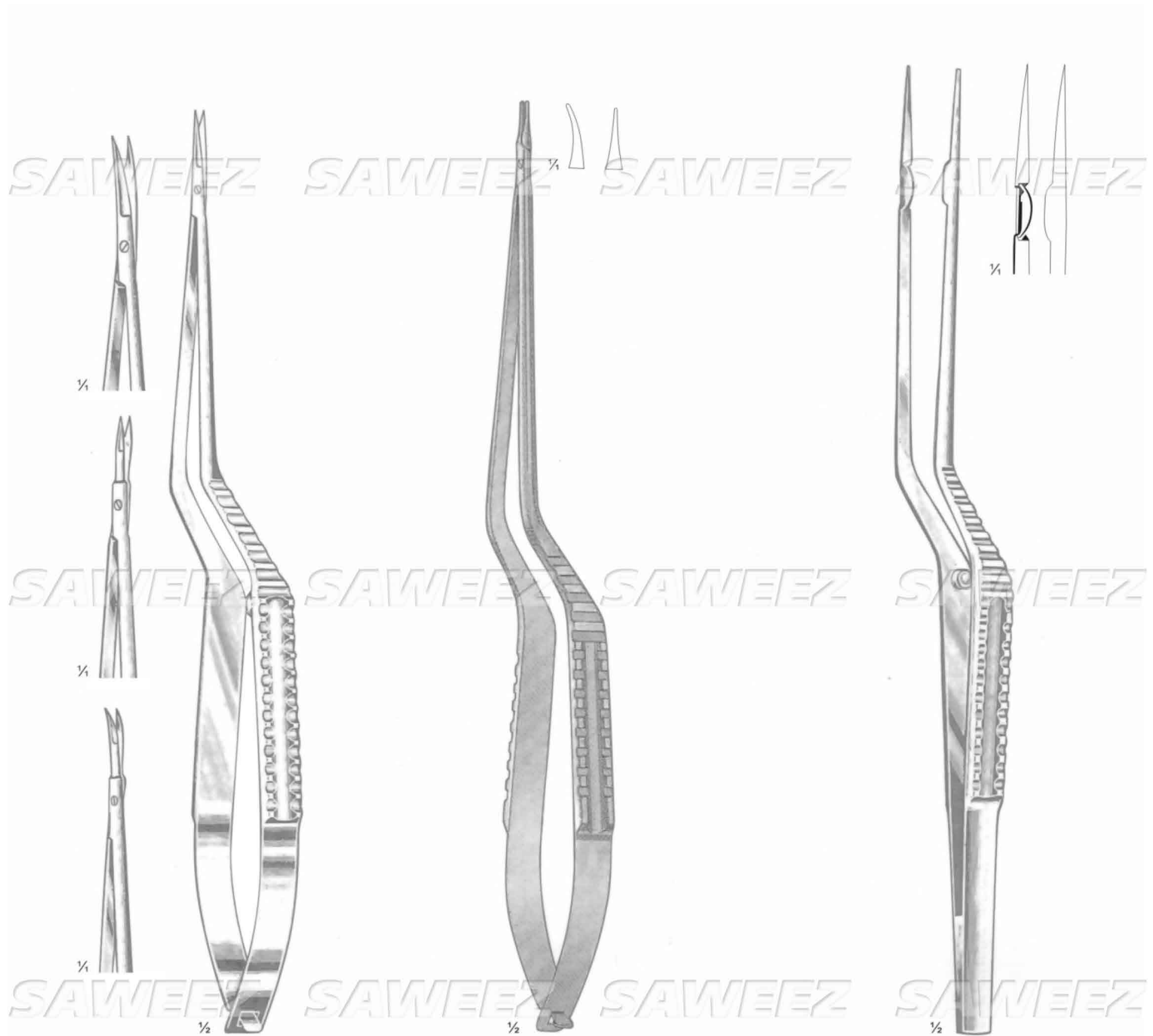
- SSC-53-11-33 Straight jaw
- SSC-53-11-34 Curved jaw
- SSC-53-11-35 Straight jaw, catch
- SSC-53-11-36 Curved jaw, catch

Microsurgical Needle Holders
with handle, 15.0cm / 6"

- SSC-53-11-37 Straight jaw
- SSC-53-11-38 Curved jaw

Microsurgical Needle Holders
round handle, 18.0cm / 7"

- SSC-53-11-39 Straight jaw, micro tip
- SSC-53-11-40 Straight jaw, micro tip, catch
- SSC-53-11-41 Straight jaw, delicate tip
- SSC-53-11-42 Straight jaw, delicate tip, catch
- SSC-53-11-43 Curved jaw, micro tip
- SSC-53-11-44 Curved jaw, micro tip, catch
- SSC-53-11-45 Curved jaw, delicate tip
- SSC-53-11-46 Curved jaw, delicate tip, catch



Yasargil Scissors
bayonet handle, 22.0cm / 8³/₄"

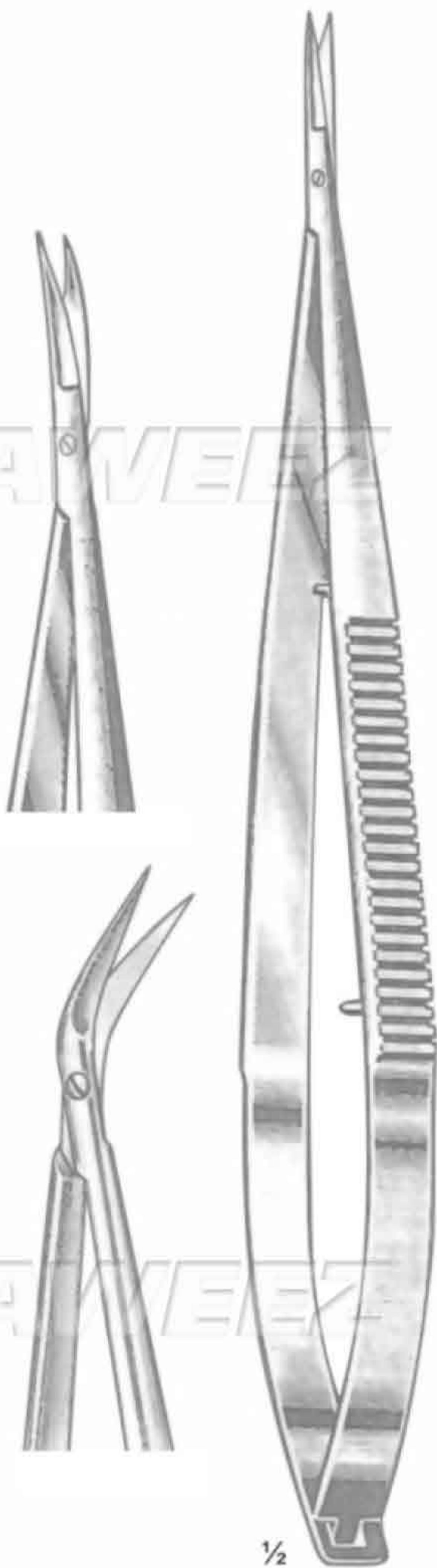
- SSC-53-11-47 Straight, regular blade
- SSC-53-11-48 Curved, regular blade
- SSC-53-11-49 Straight, regular blade
- SSC-53-11-50 Curved, regular blade

Yasargil Needle Holders
bayonet handle, 22.0cm / 8³/₄"

- SSC-53-11-51 Straight jaw
- SSC-53-11-52 Curved jaw

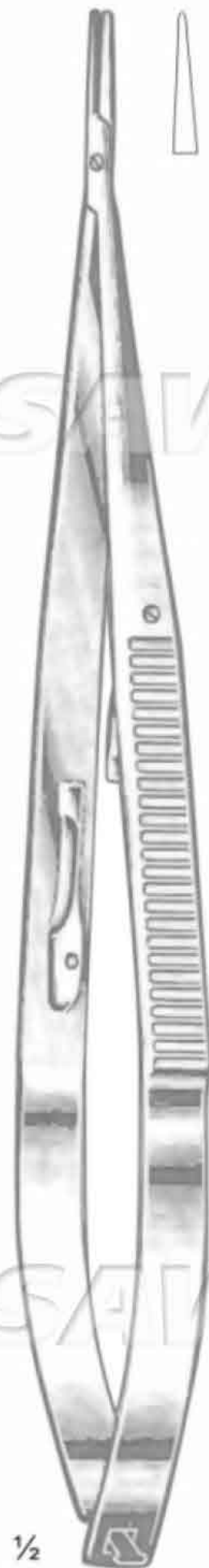
Yasargil Forceps
bayonet handle, 22.0cm / 8³/₄"

- SSC-53-11-53 Blunt tip
- SSC-53-11-54 Sharp tip



Jacobson Scissors
straight handle, 18.5cm / 7 1/4"

- SSC-53-11-55 Straight blade
- SSC-53-11-56 Curved blade
- SSC-53-11-57 Angled on edge



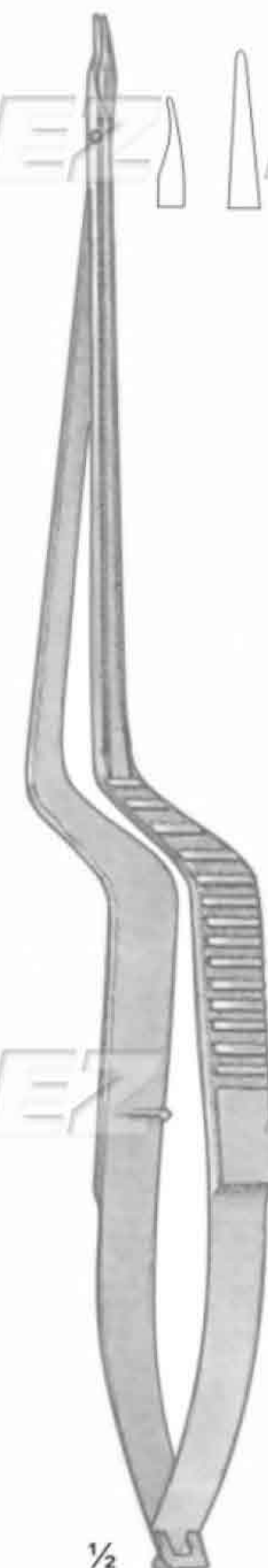
Jacobson Needle Holders
straight handle, 18.5cm / 7"

- SSC-53-11-63 without catch
- SSC-53-11-64 with catch



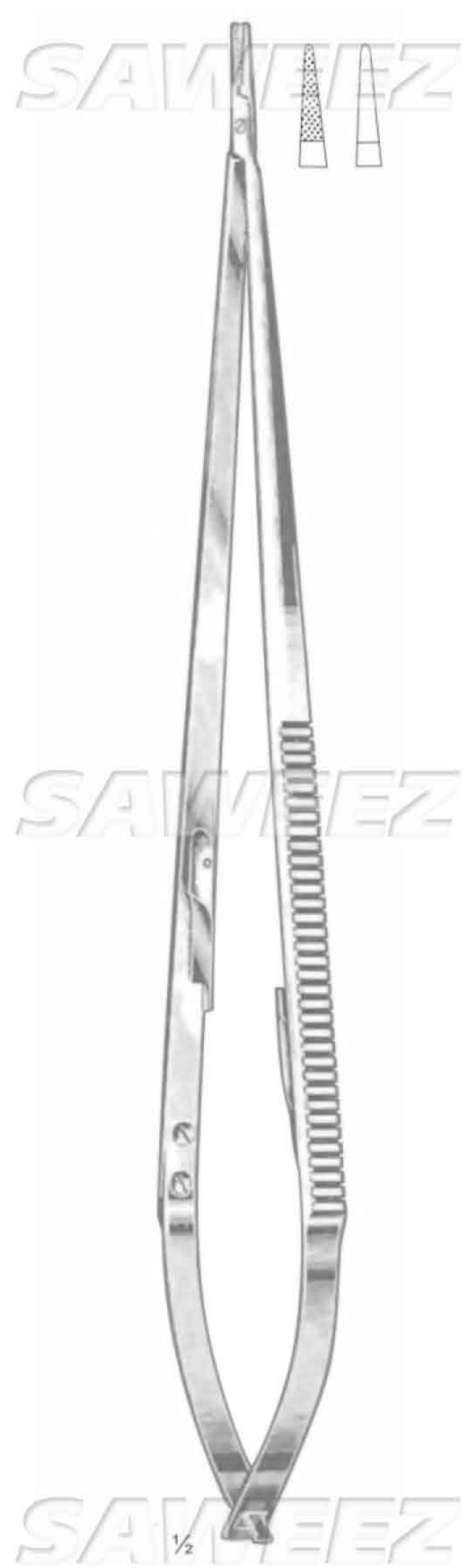
Jacobson Scissors
bayonet handle, 18.5cm / 7 1/4"

- SSC-53-11-58 Straight, regular blade
- SSC-53-11-59 Curved, regular blade
- SSC-53-11-60 Angled on edge, regular blade
- SSC-53-11-61 Straight, micro blade
- SSC-53-11-62 Curved, micro blade



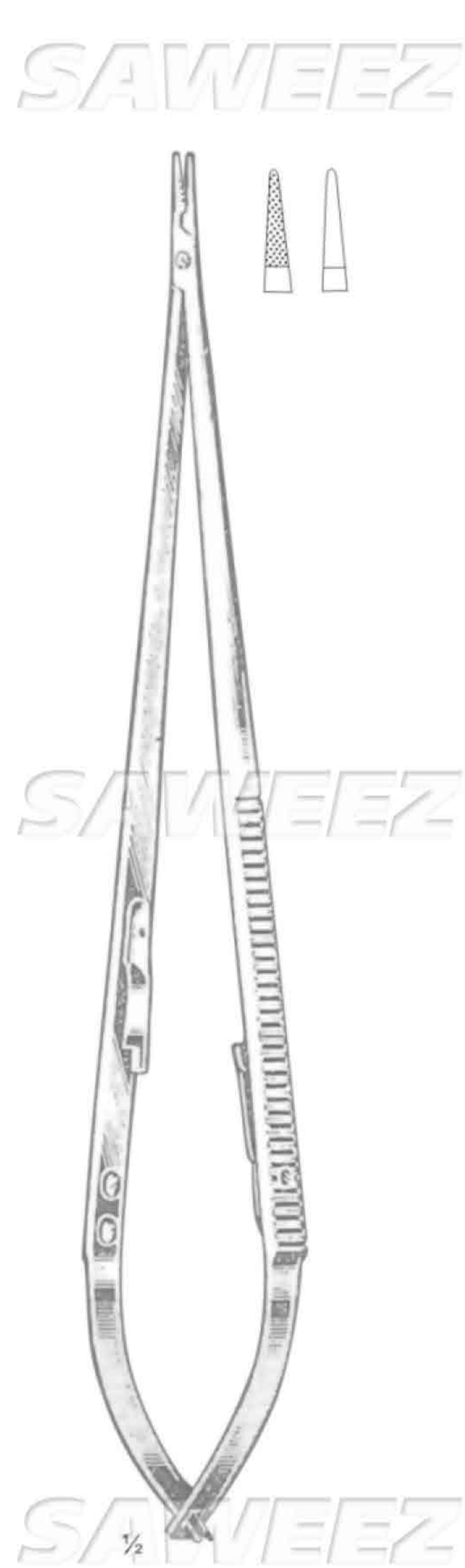
Jacobson Needle Holders
straight handle, without catch
18.0cm / 7"

- SSC-53-11-65 Straight jaw
- SSC-53-11-66 Fine curved jaw



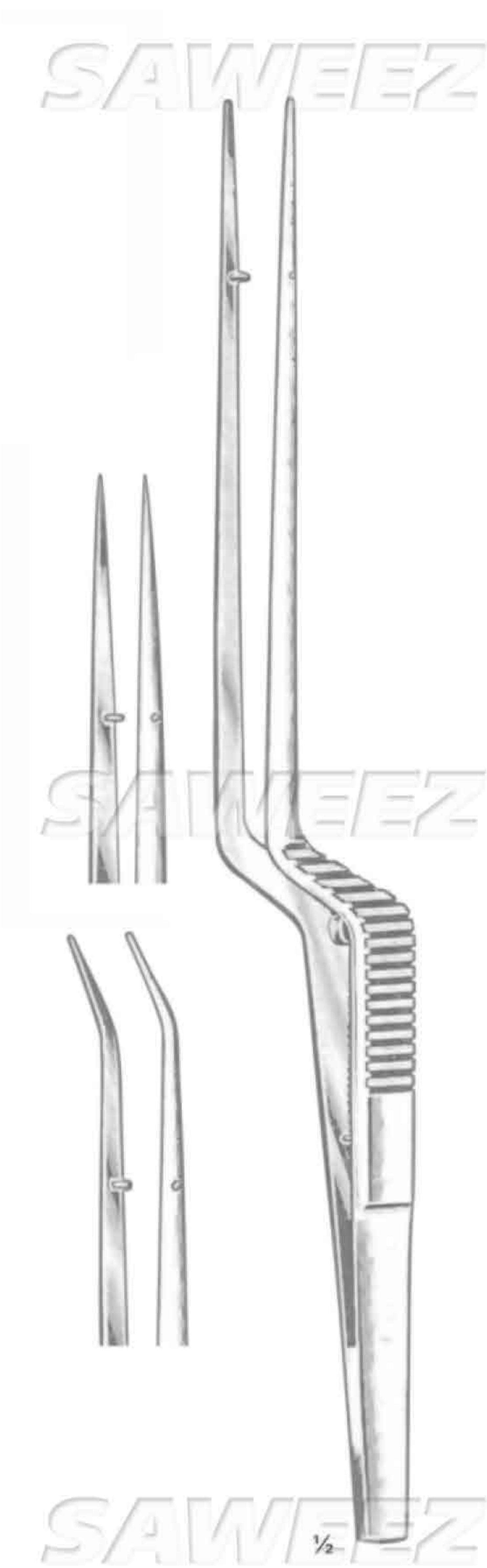
Microsurgical Needle Holders
18.0cm / 7" Carb-Bite Jaws

SSC-53-11-67 Smooth
SSC-53-11-68 Serrated



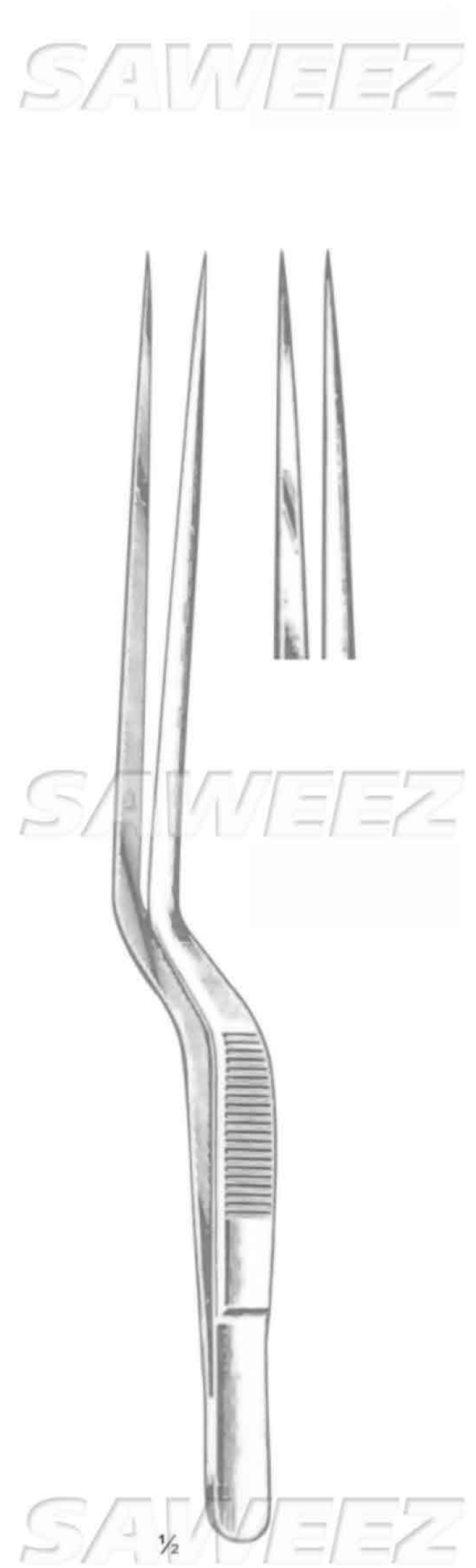
Microsurgical Needle Holders
21.5cm / 8½" Carb-Bite Jaws

SSC-53-11-69 Smooth
SSC-53-11-70 Serrated



Jacobson Forceps
bayonet handle, 16.0 cm / 6¼"
sharp tips

SSC-53-11-71



Jacobson Forceps
bayonet handle, 18.5 cm / 7¼"
sharp tips

SSC-53-11-72 Blunt tips
SSC-53-11-73 Sharp tips
SSC-53-11-74 Angled blunt tips

**Eye Dressing Forceps**

SSC-55-11-11

10.0 cm / 4", delicate,
serrated, straight,
0.7mm wide at tip**Eye Dressing Forceps**

SSC-55-11-12

10.0 cm / 4",
serrated, straight,
0.8mm wide at tip**Eye Dressing Forceps**

SSC-55-11-13

9.9 cm / 3⁷/₈", delicate,
serrated, half curved
0.7mm wide at tip**Eye Dressing Forceps**

SSC-55-11-14

9.9 cm / 3⁷/₈",
serrated, half curved
0.8mm wide at tip**Eye Dressing Forceps**

SSC-55-11-15

9.7 cm / 3³/₈", delicate,
serrated, full curved
0.7mm wide at tip**Eye Dressing Forceps**

SSC-55-11-16

9.7 cm / 3³/₈",
serrated, full curved
0.8mm wide at tip**Iris Forceps**

SSC-55-11-17

10.0 cm / 4", delicate,
serrated, 1x2 teeth,
0.7mm wide at tip**Iris Forceps**

SSC-55-11-18

10.0 cm / 4",
serrated, 1x2 teeth,
0.8mm wide at tip**Iris Forceps**

SSC-55-11-19

9.9 cm / 3⁷/₈", delicate,
half curved, 1x2 teeth
0.7mm wide at tip**Iris Forceps**

SSC-55-11-20

9.9 cm / 3⁷/₈",
half curved, 1x2 teeth
0.8mm wide at tip**Iris Forceps**

SSC-55-11-21

9.7 cm / 3³/₈", delicate,
full curved, 1x2 teeth
0.7mm wide at tip**Iris Forceps**

SSC-55-11-22

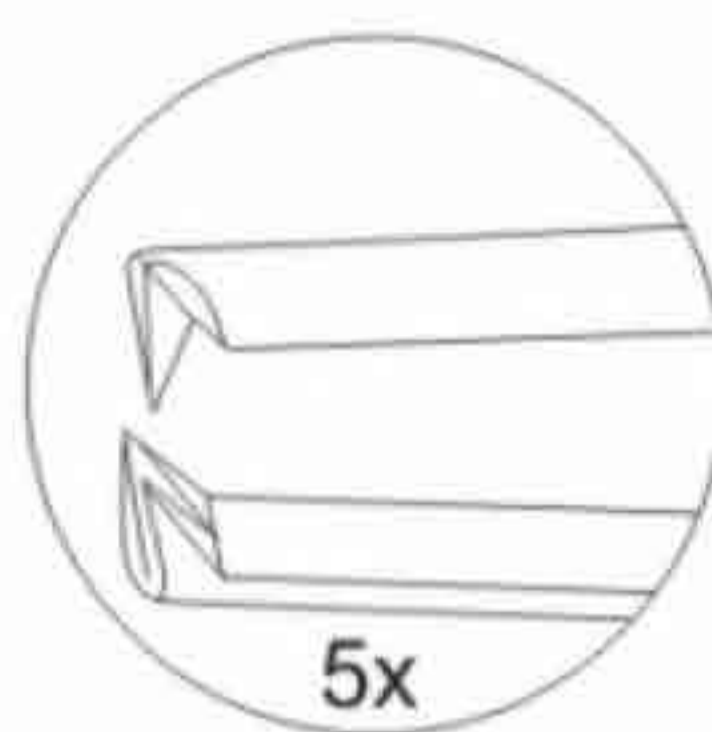
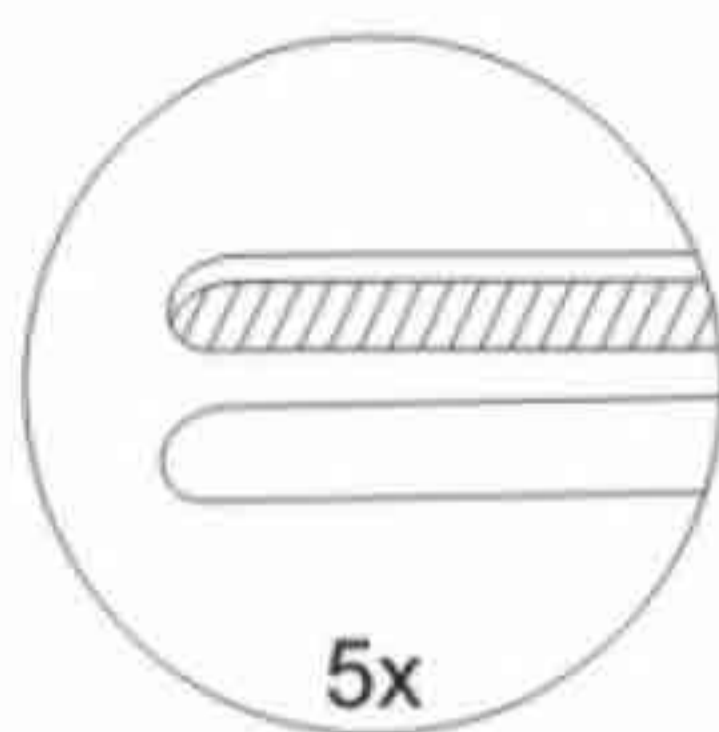
9.7 cm / 3³/₈",
full curved, 1x2 teeth
0.8mm wide at tip



Von Graefe Iris Forceps

7.2 cm / 2¾", straight, 0.7mm tip

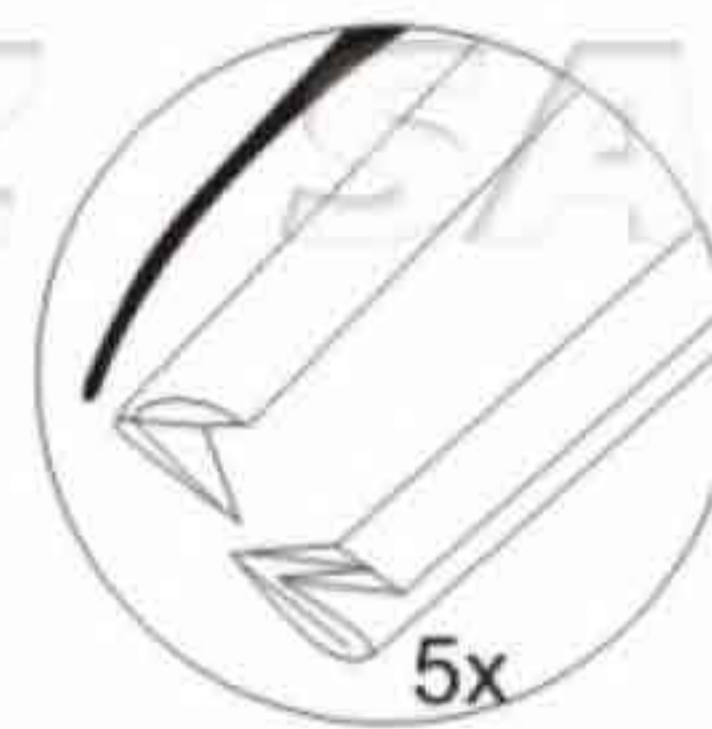
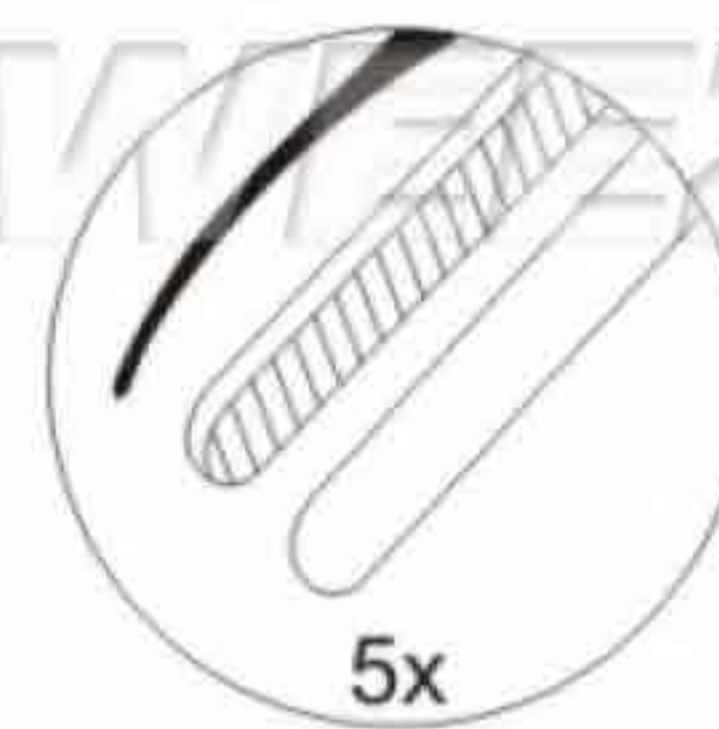
- SSC-55-11-23 Serrated
- SSC-55-11-24 1 x 2 teeth



Von Graefe Iris Forceps

7.2 cm / 2¾", straight, 0.7mm tip

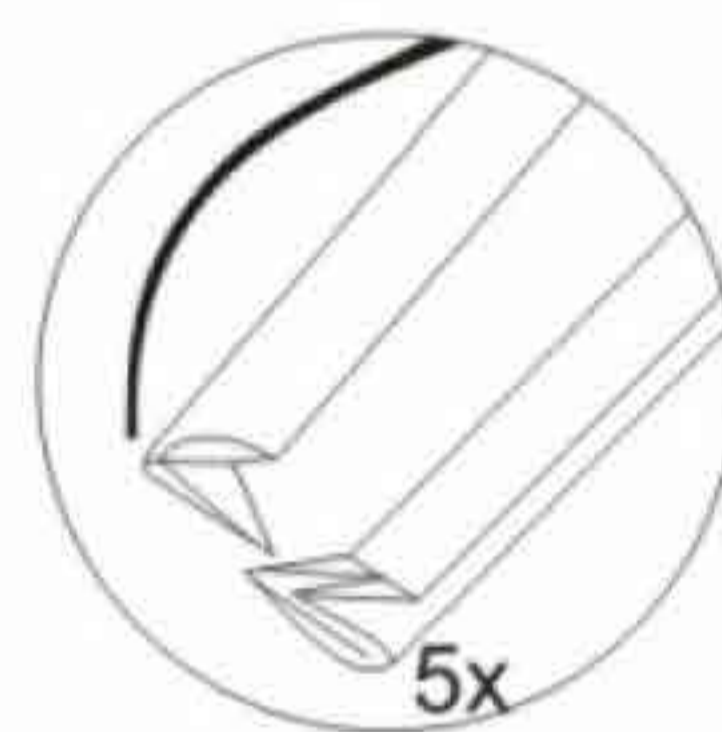
- SSC-55-11-25 Serrated
- SSC-55-11-26 1 x 2 teeth



Gill Iris Forceps

7.5 cm / 3", curved, 0.5mm tip,
1 x 2 teeth

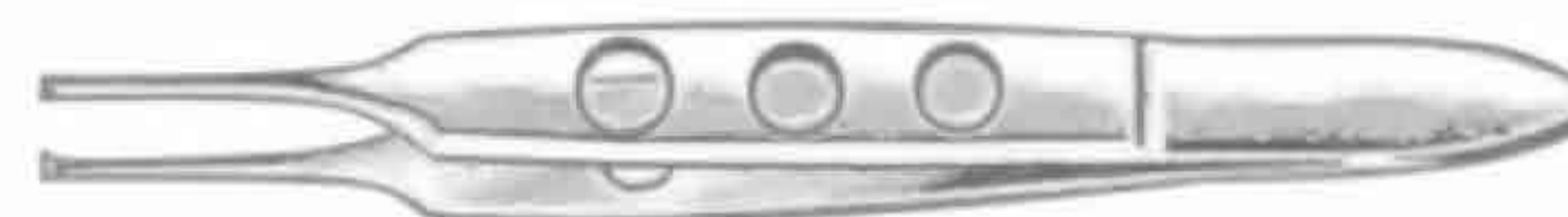
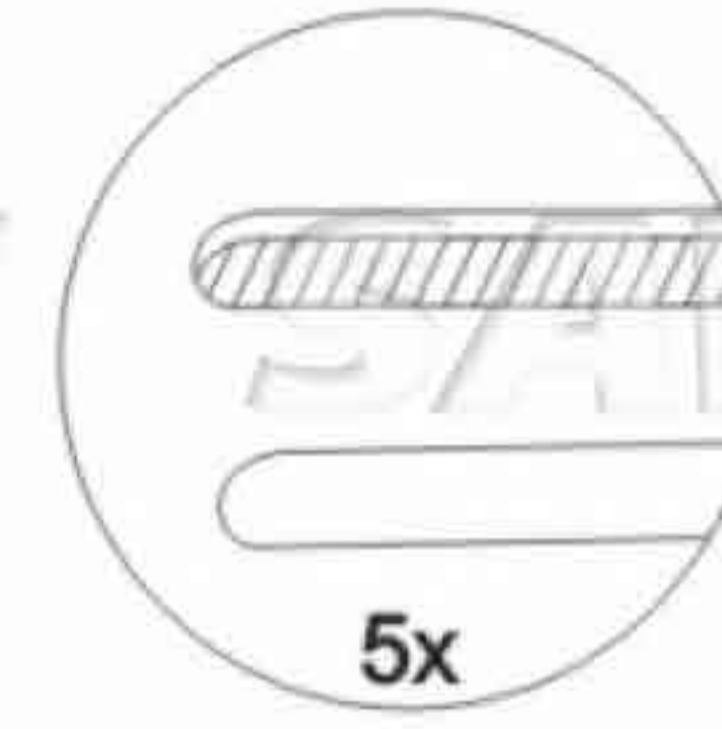
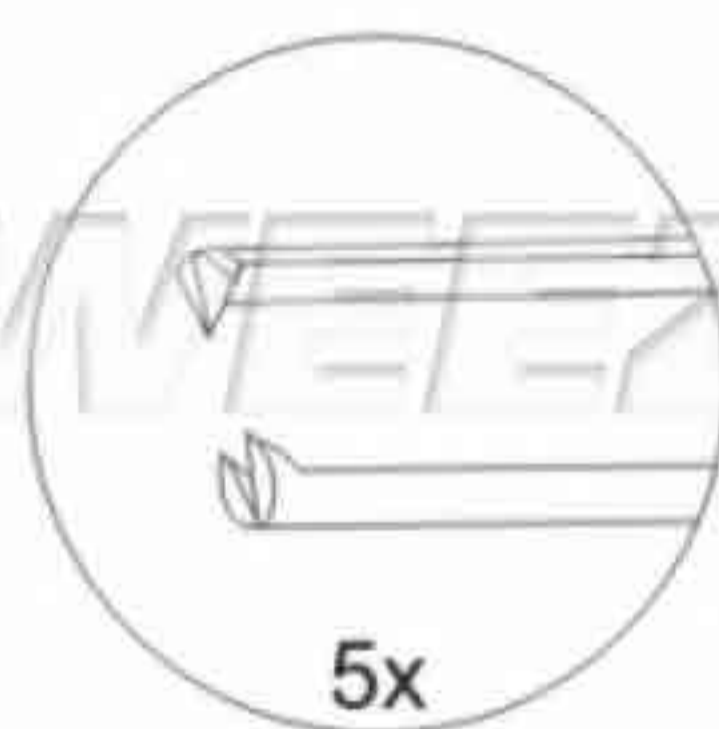
SSC-55-11-27



Bishop Harmon Iris Forceps

8.9 cm / 3½"

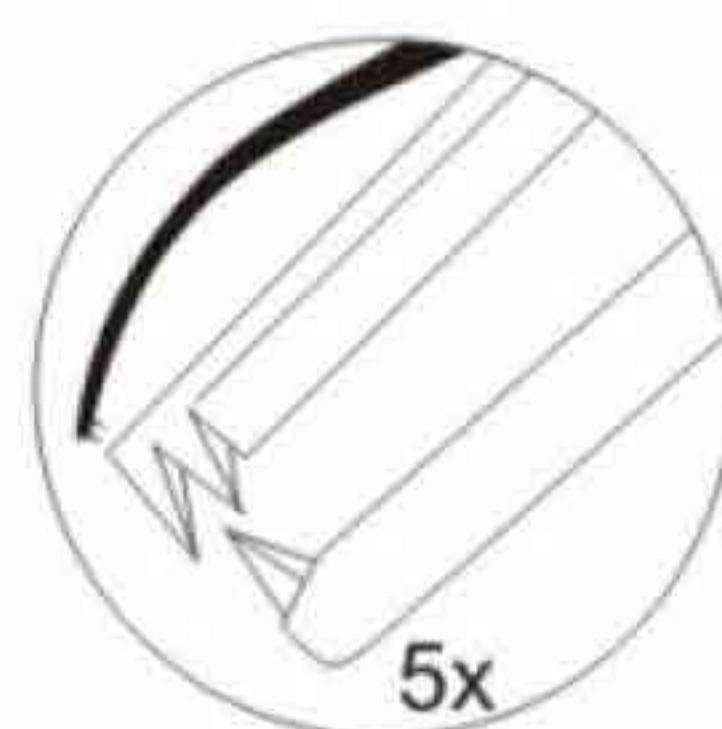
- SSC-55-11-28 - 0.6mm, 1 x 2 teeth
- SSC-55-11-29 - 0.4mm, 1 x 2 teeth, extra delicate
- SSC-55-11-30 - 0.3mm, 1 x 2 teeth, micro surgery
- SSC-55-11-31 - 0.6mm, serrated



Gill Iris Forceps

7.5 cm / 3", curved, 0.6mm tip,
1 x 2 teeth down

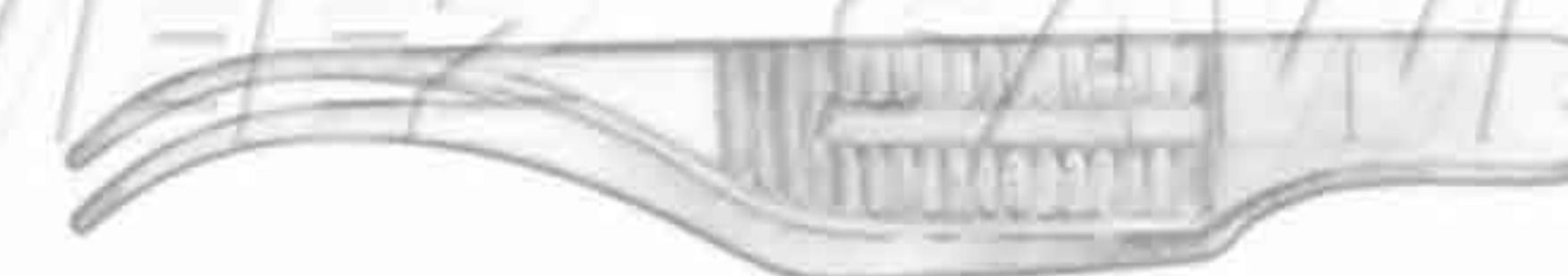
SSC-55-11-32



Gill Iris Forceps

7.5 cm / 3", curved,
cross-serrated

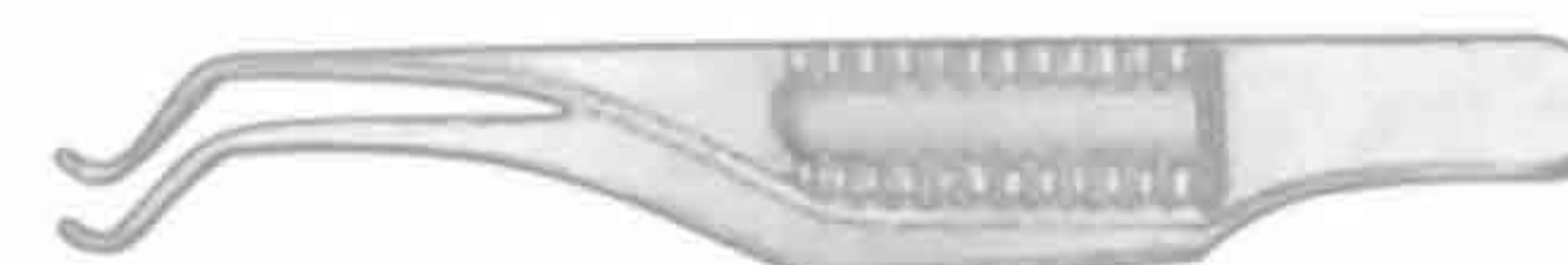
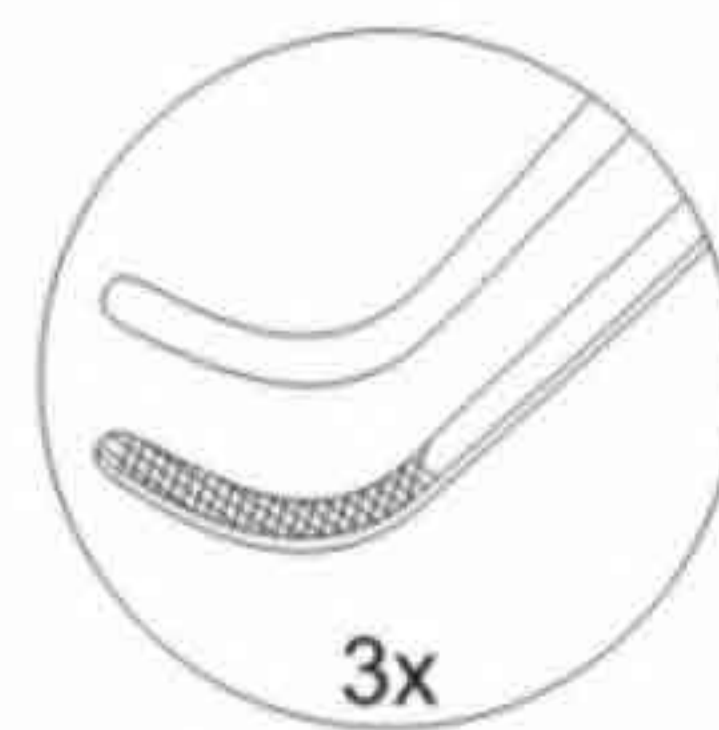
SSC-55-11-33



Botvin Iris Forceps

7.5 cm / 3", bayonet-shaped,
cross-serrated

SSC-55-11-34

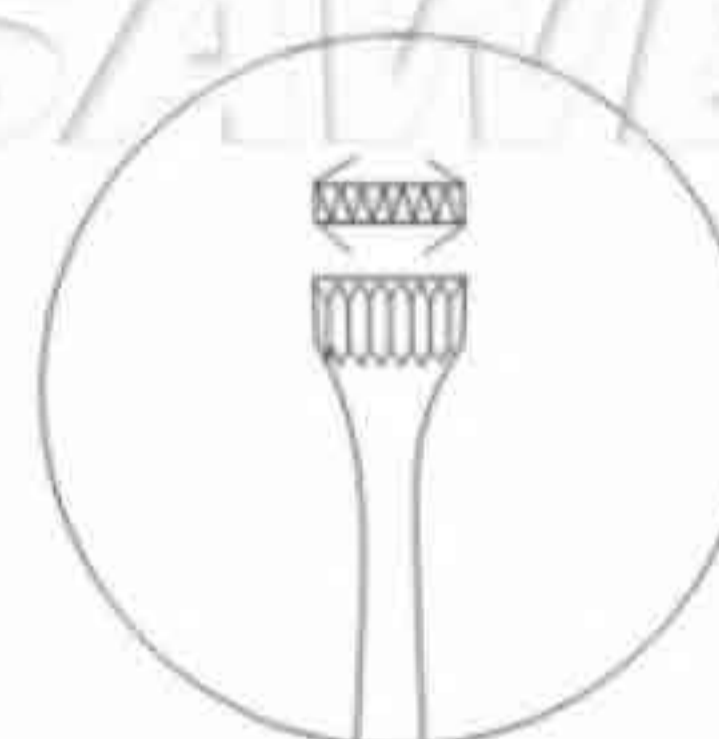




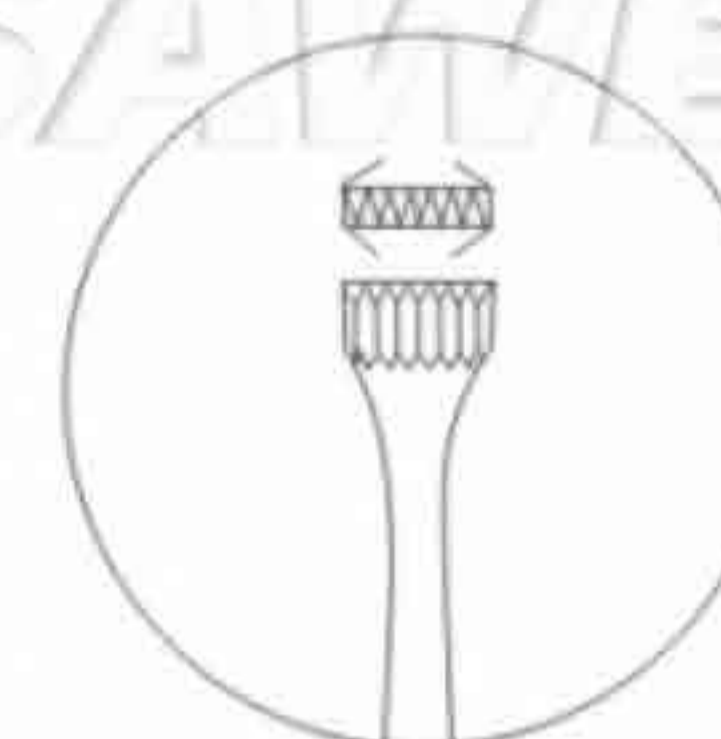
Elsching Fixation Forceps
10.6 cm / 4 $\frac{1}{16}$ "
1 x 2 teeth
SSC-55-11-35



Thorpe Conjunctival Fixation Forceps
9.5 cm / 3 $\frac{3}{4}$ "
2 x 3 teeth with tying platform
SSC-55-11-36



Von Graefe Fixation Forceps
11.4 cm / 4 $\frac{1}{2}$ "
with catch, 4.5mm jaws
SSC-55-11-37



Von Graefe Fixation Forceps
11.4 cm / 4 $\frac{1}{2}$ "
plain, 4.5mm jaws
SSC-55-11-38



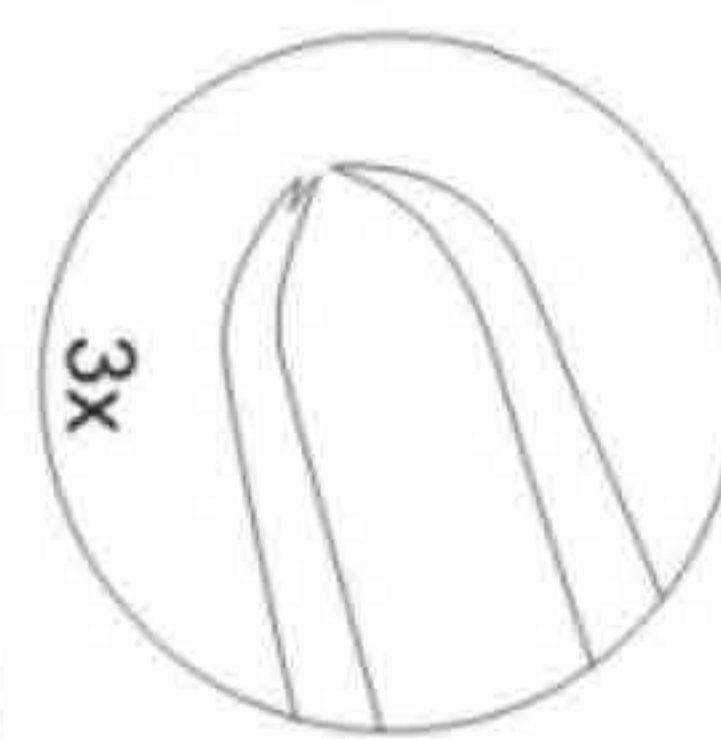
Lester Fixation Forceps
9.7 cm / 3 $\frac{7}{8}$ "
2 x 3 teeth
SSC-55-11-39



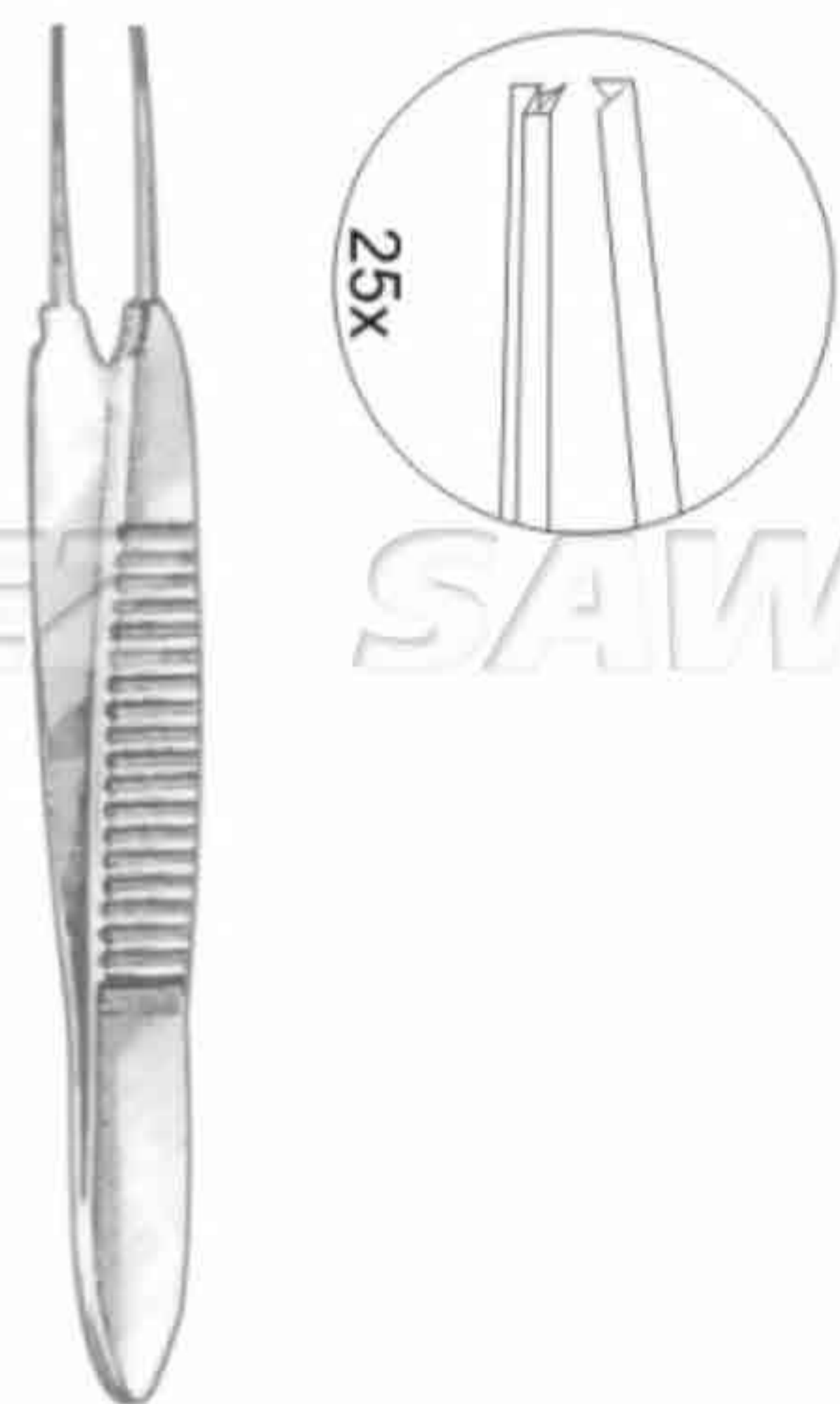
Lester Fixation Forceps
9.7 cm / 3 $\frac{7}{8}$ "
1 x 2 teeth
SSC-55-11-40



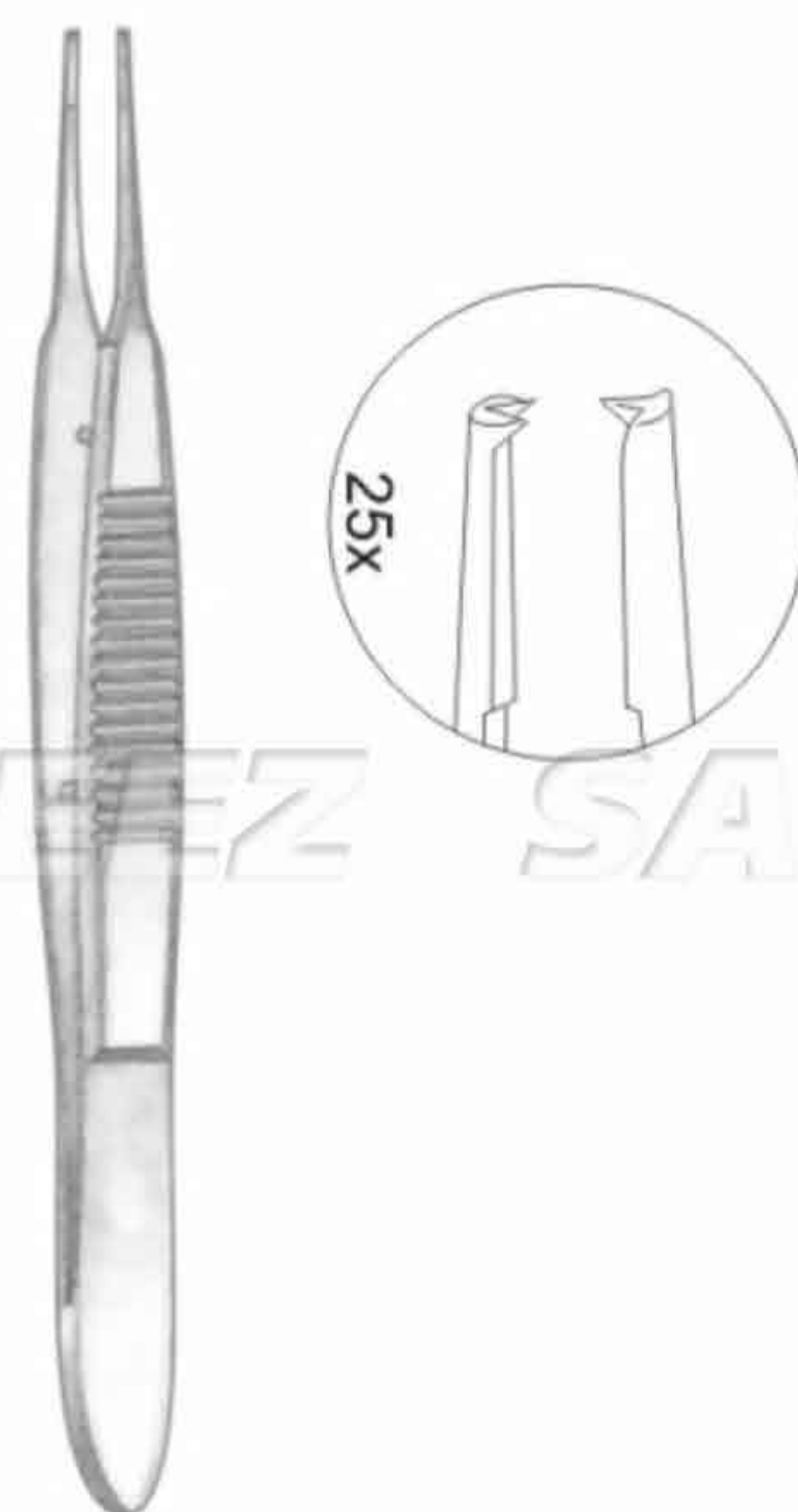
Green Fixation Forceps
10.2 cm / 4"
10mm jaws with fine teeth
SSC-55-11-41



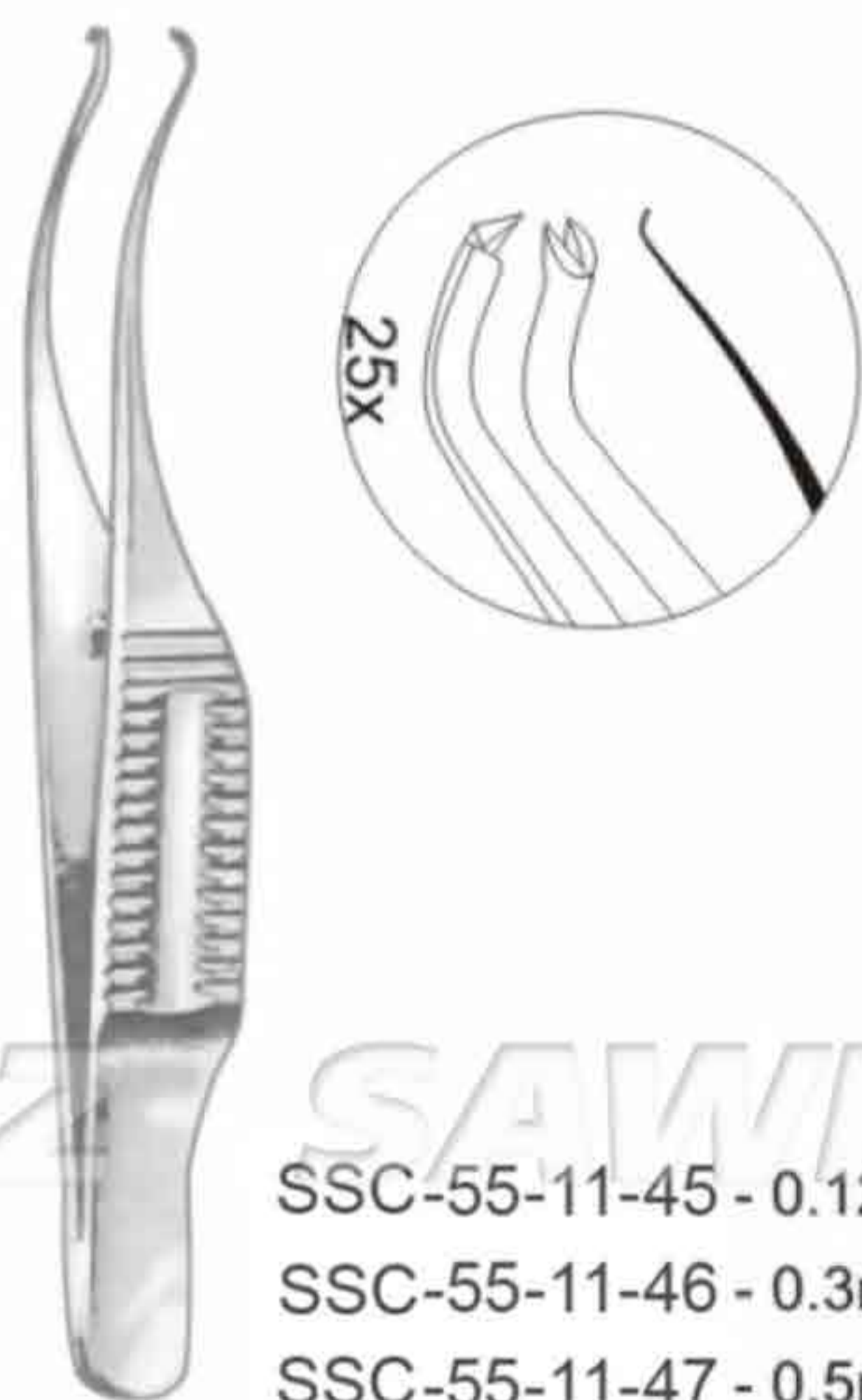
Bracken Fixation Forceps
10.8 cm / 4 $\frac{1}{4}$ "
1 x 2 teeth
SSC-55-11-42



Bonn Iris Forceps
 7.0 cm / 2¾"
 0.12mm teeth
 original pattern,
 without tying platform
 SSC-55-11-43

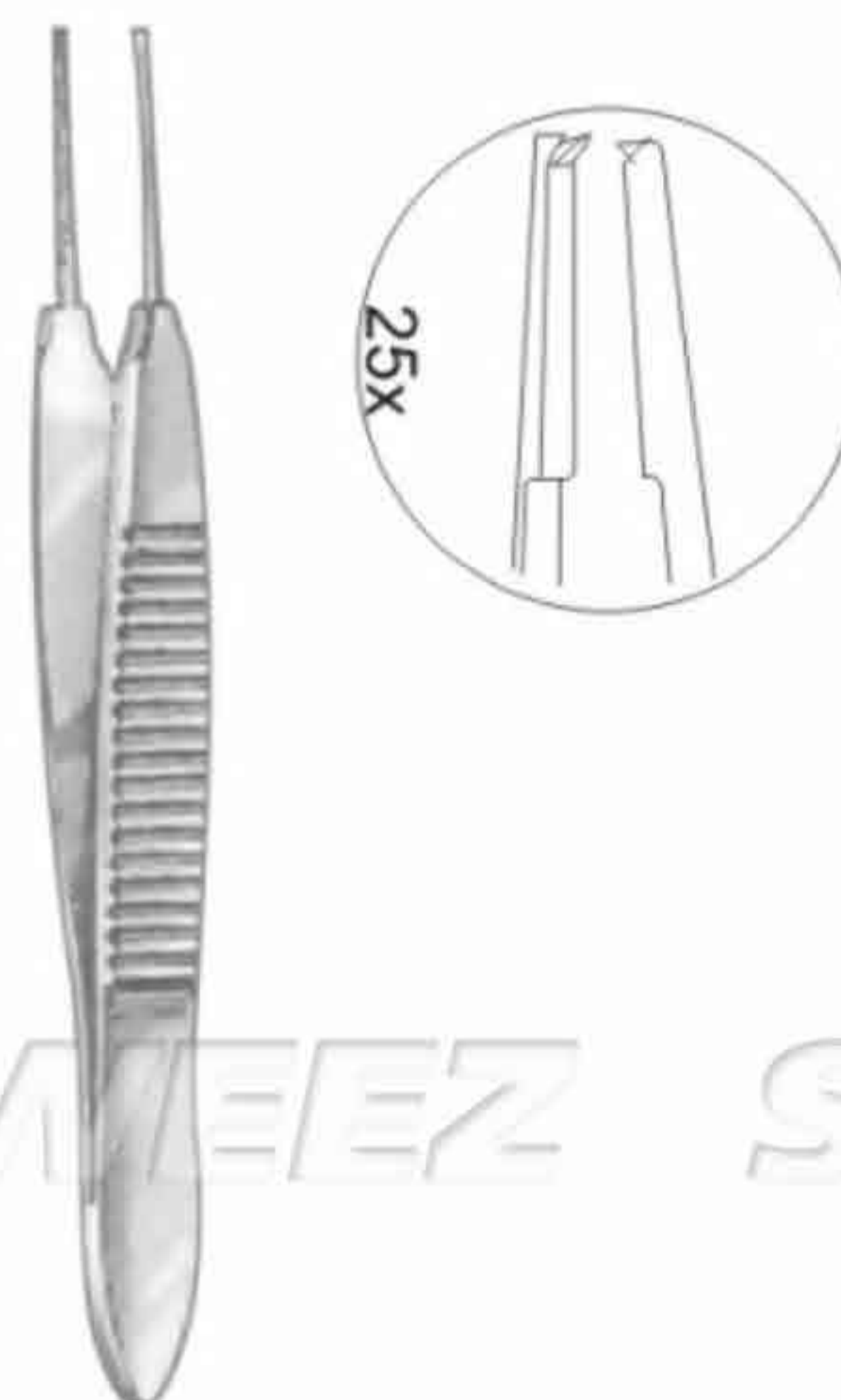


Bonn Suture Forceps
 9.5 cm / 3¾"
 0.12mm teeth
 5mm tying platform
 SSC-55-11-44

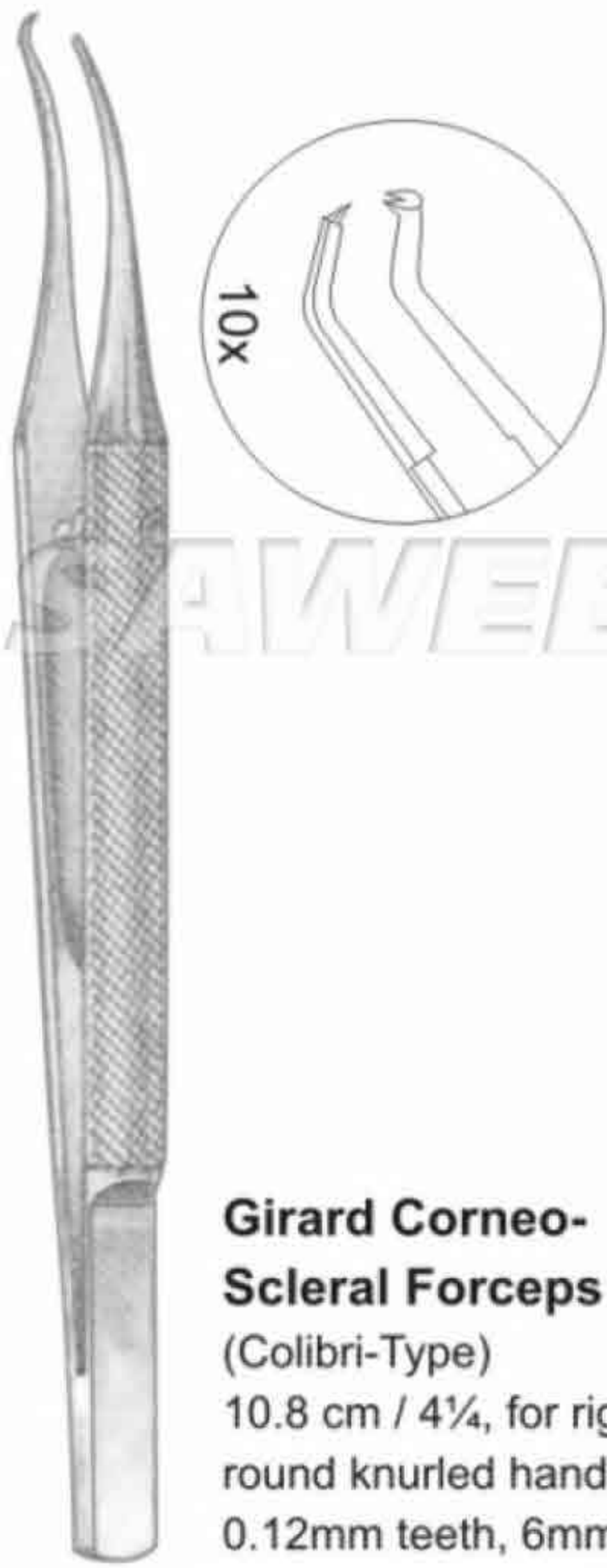


Stoutman-Barraquer Utility Forceps (Colibri-Type)
 5 cm / 2 1/8" teeth at 45° angle,
 4mm tying platform

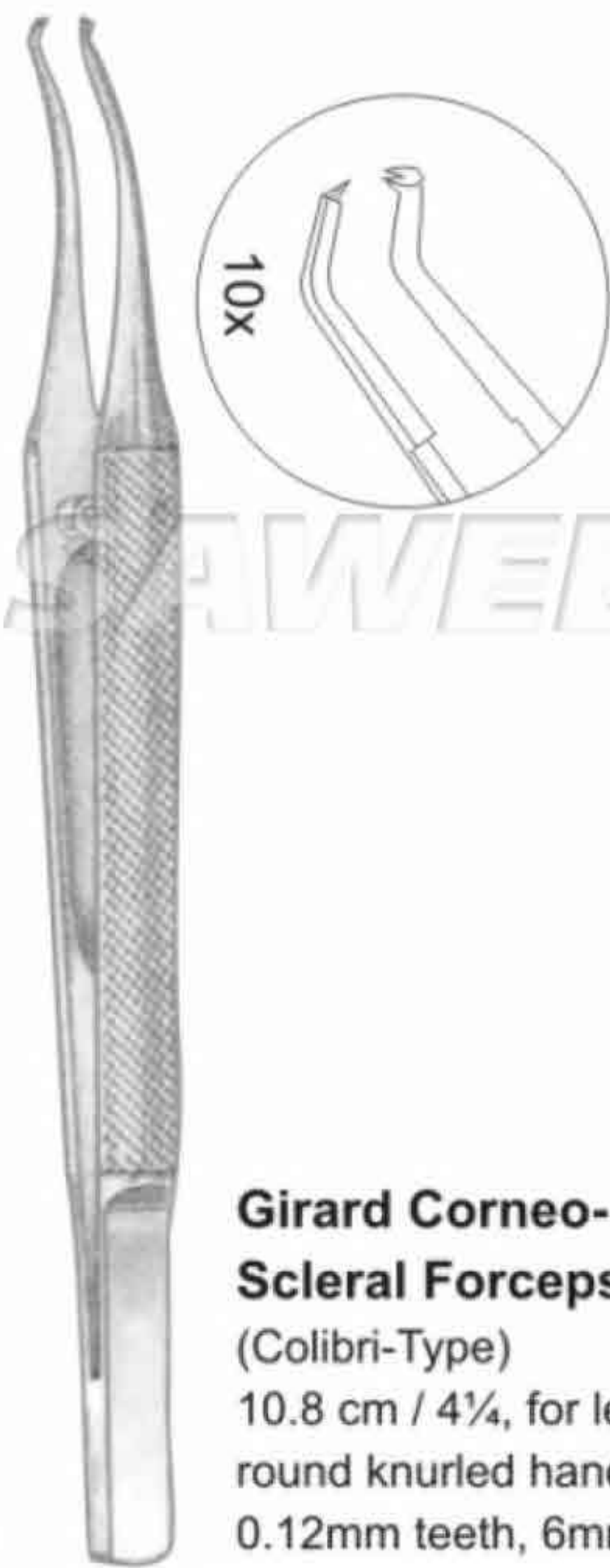
- SSC-55-11-45 - 0.12mm teeth
- SSC-55-11-46 - 0.3mm teeth
- SSC-55-11-47 - 0.5mm teeth



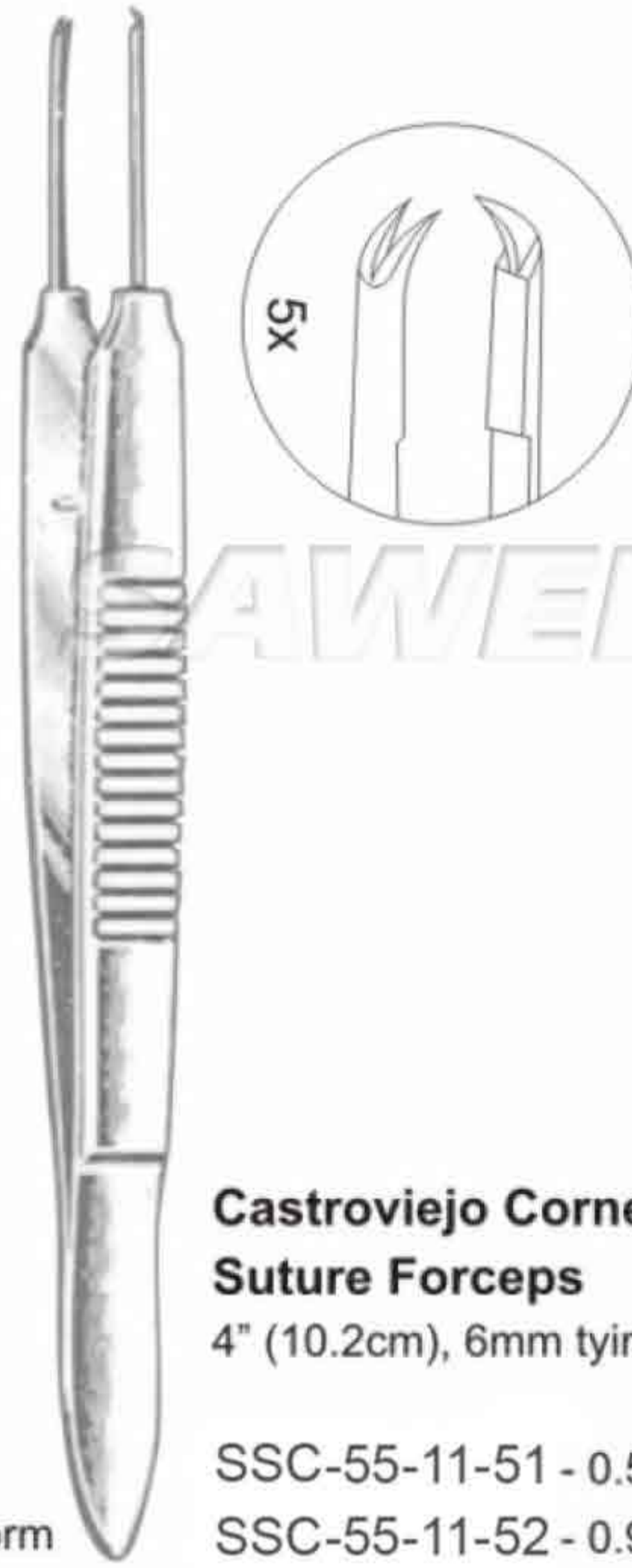
Bonn Iris Forceps
 7.0 cm / 3¾"
 0.12mm teeth
 4mm tying platform
 SSC-55-11-48



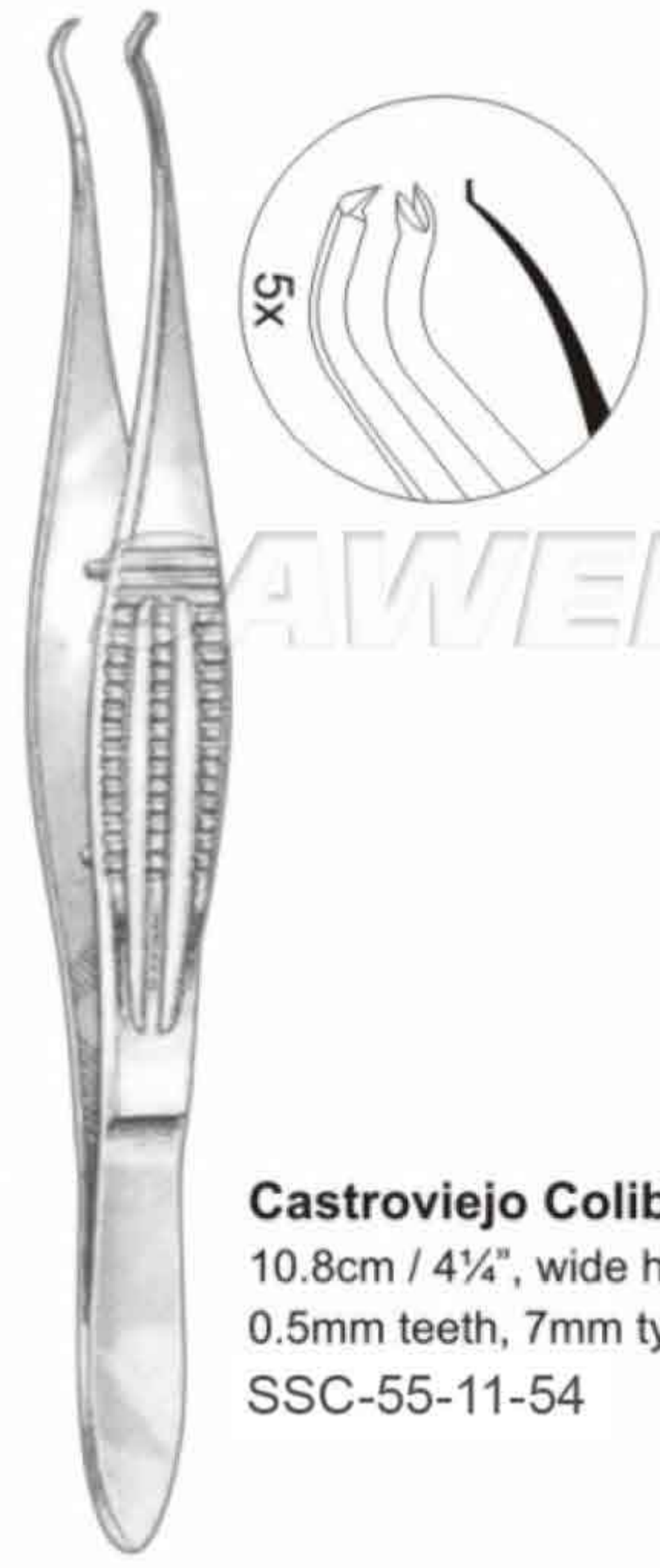
Girard Corneo-Scleral Forceps
(Colibri-Type)
10.8 cm / 4¼", for right hand,
round knurled handle,
0.12mm teeth, 6mm tying platform
SSC-55-11-49



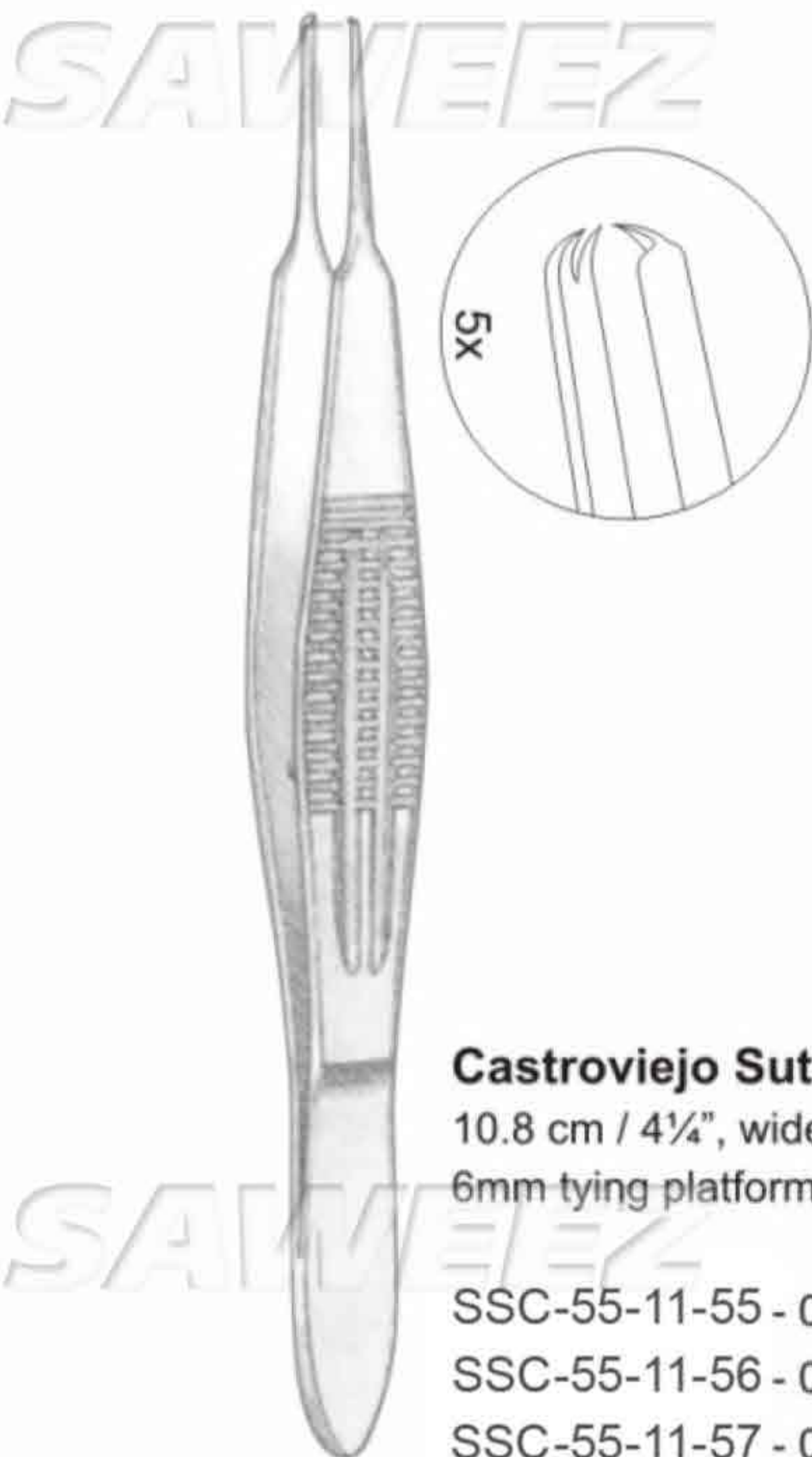
Girard Corneo-Scleral Forceps
(Colibri-Type)
10.8 cm / 4¼", for left hand,
round knurled handle,
0.12mm teeth, 6mm tying platform
SSC-55-11-50



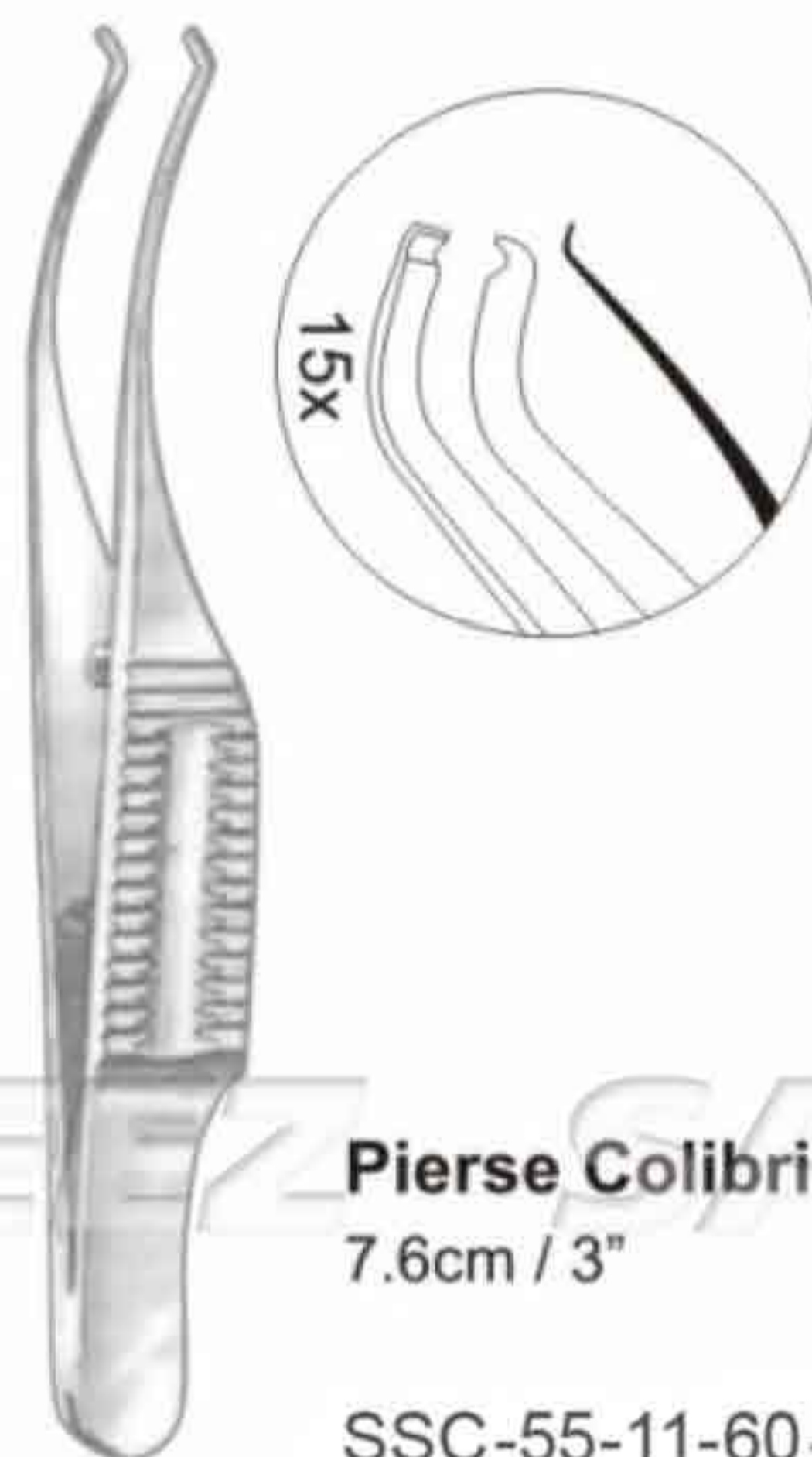
Castroviejo Corneo-Scleral Suture Forceps
4" (10.2cm), 6mm tying platform
SSC-55-11-51 - 0.5mm teeth
SSC-55-11-52 - 0.9mm teeth
SSC-55-11-53 - 1.5mm teeth



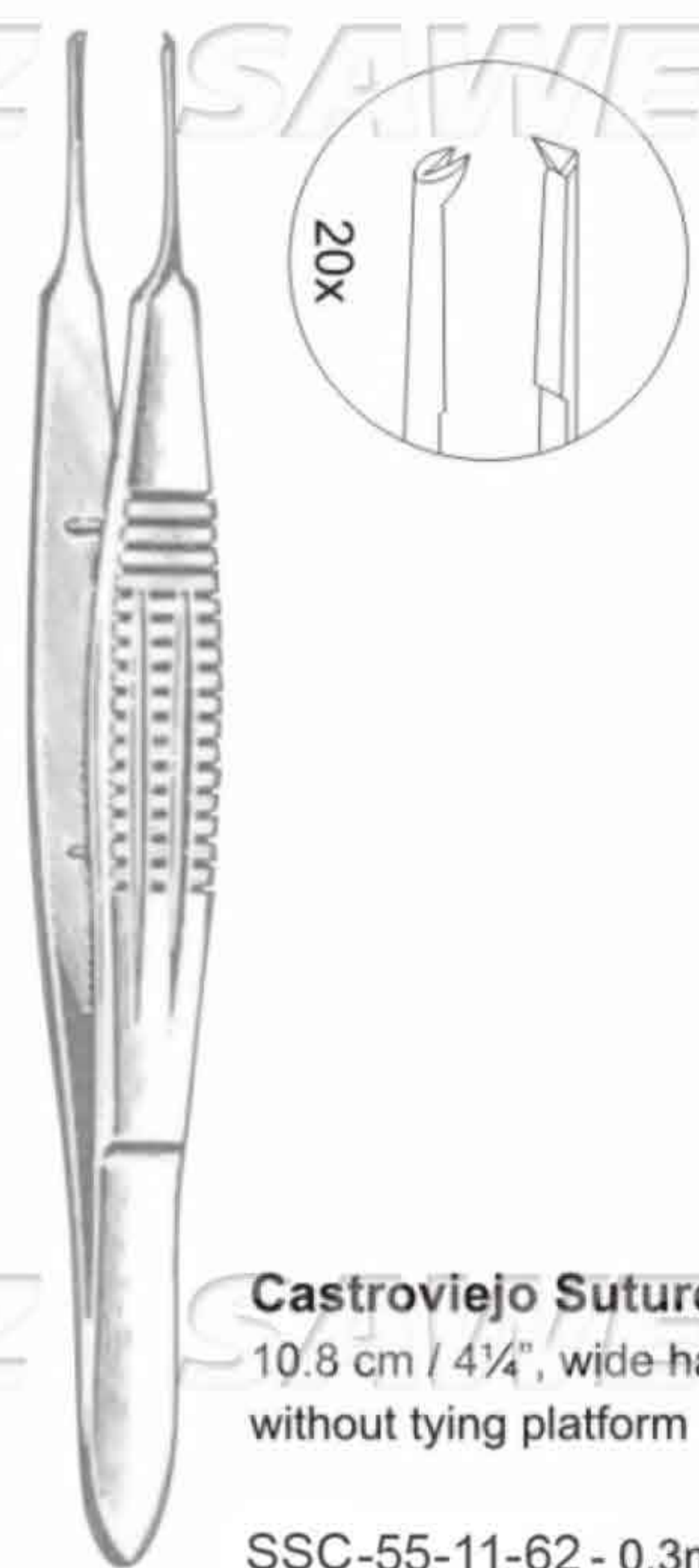
Castroviejo Colibri Forceps
10.8cm / 4¼", wide handle,
0.5mm teeth, 7mm tying platform
SSC-55-11-54



Castroviejo Suture Forceps
10.8 cm / 4¼", wide handle,
6mm tying platform
SSC-55-11-55 - 0.12mm teeth
SSC-55-11-56 - 0.3mm teeth
SSC-55-11-57 - 0.5mm teeth
SSC-55-11-58 - 0.9mm teeth
SSC-55-11-59 - 1.5mm teeth



Pierser Colibri Forceps
7.6cm / 3"
SSC-55-11-60 - 0.1mm teeth
SSC-55-11-61 - 0.3mm teeth



Castroviejo Suture Forceps
10.8 cm / 4¼", wide handle,
without tying platform
SSC-55-11-62 - 0.3mm teeth
SSC-55-11-63 - 0.5mm teeth



Jewelers Style Forceps

Style 1: fine
SSC-55-11-64



Jewelers Style Forceps

Style 3: very fine
SSC-55-11-65



Jewelers Style Forceps

Style 3C: very fine
SSC-55-11-66



Jewelers Style Forceps

Style 4: very fine
SSC-55-11-67



Jewelers Style Forceps

Style 5: very fine
SSC-55-11-68

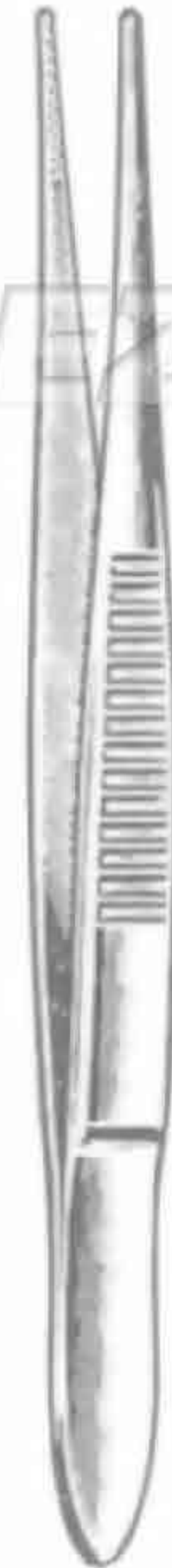


Jewelers Style Forceps

Style 7: very fine, curved
SSC-55-11-69



Nugent Utility Forceps
10.8 cm / 4¼", 45° angled jaws
SSC-55-11-70 - Smooth
SSC-55-11-71 - Cross-serrated

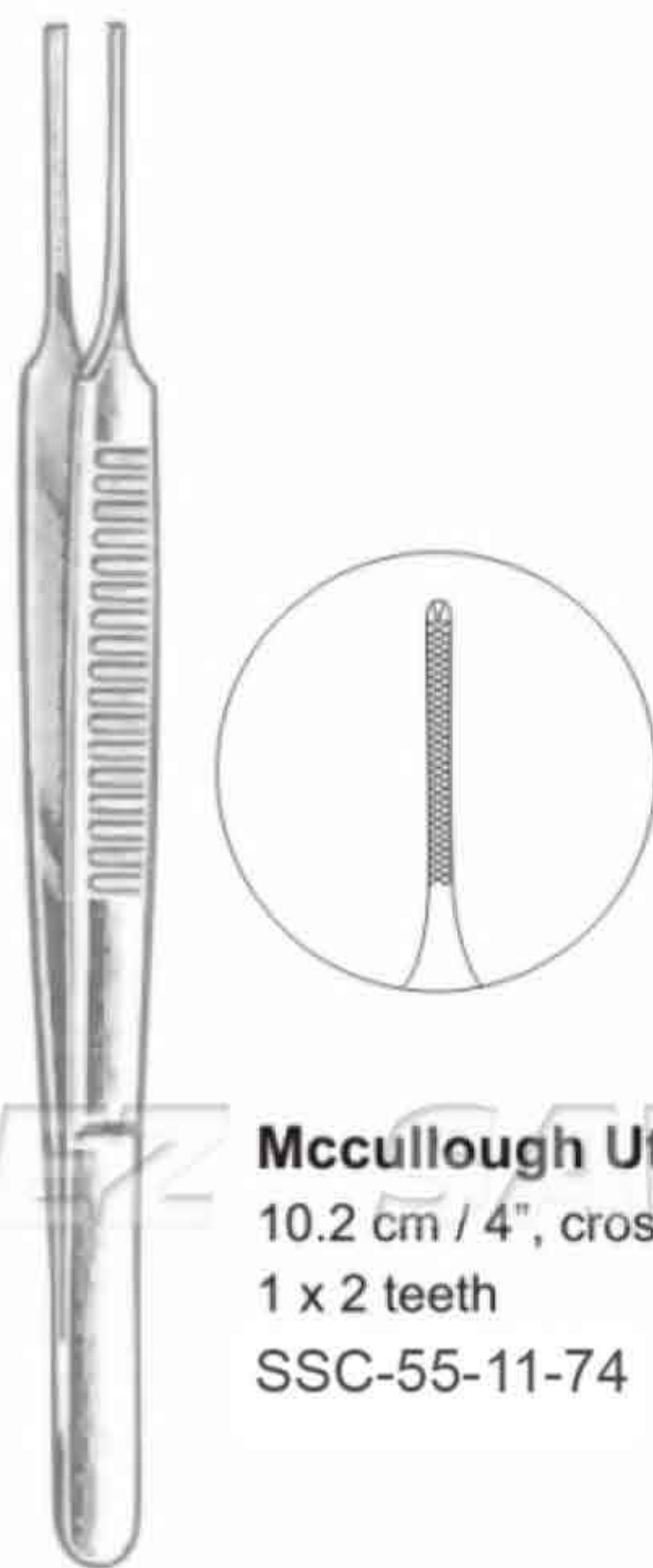


Wills Hospital Utility Forceps
10.2 cm / 4", 4cross rated
SSC-55-11-72

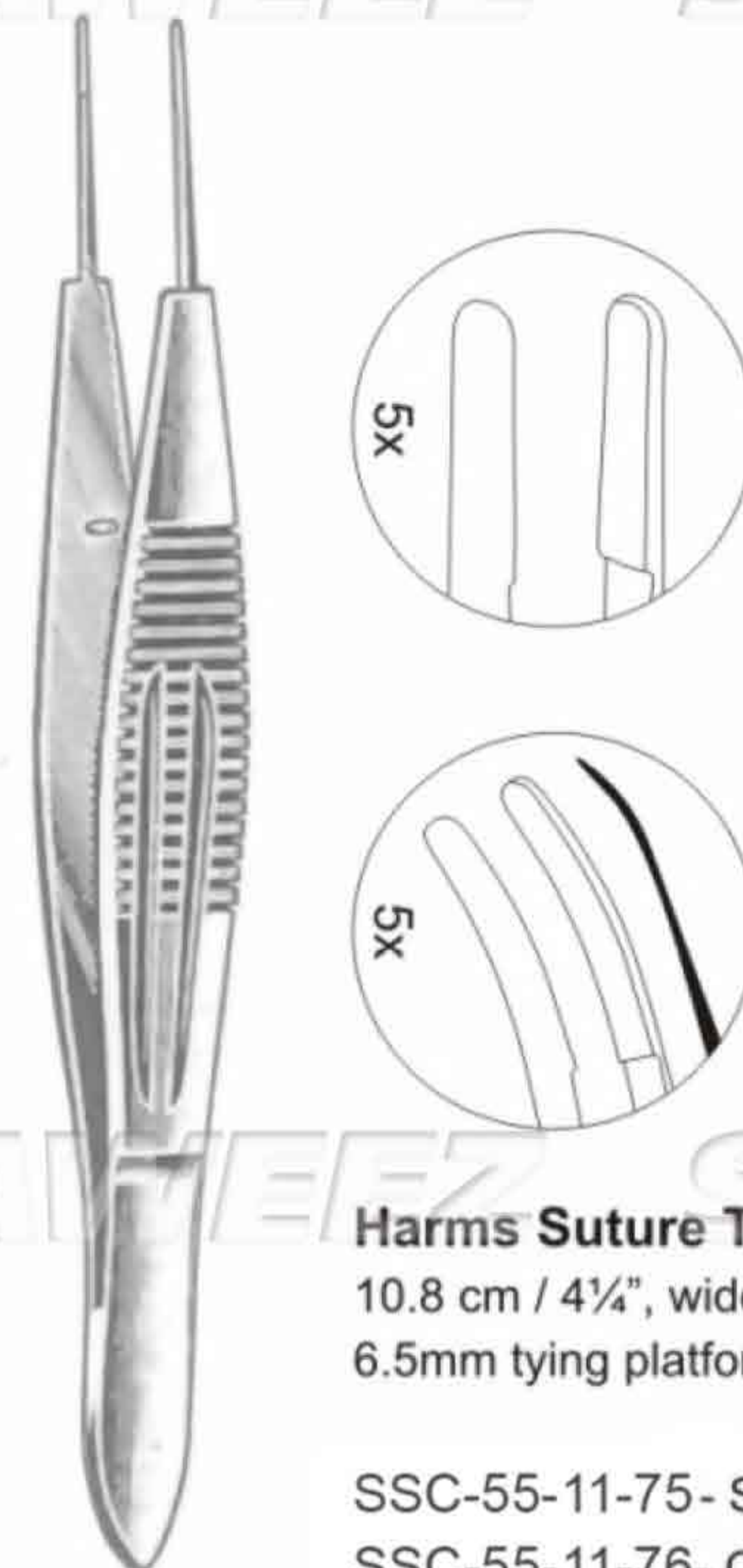


Mccullough Utility Forceps
10.2 cm / 4", cross-serrated
SSC-55-11-73

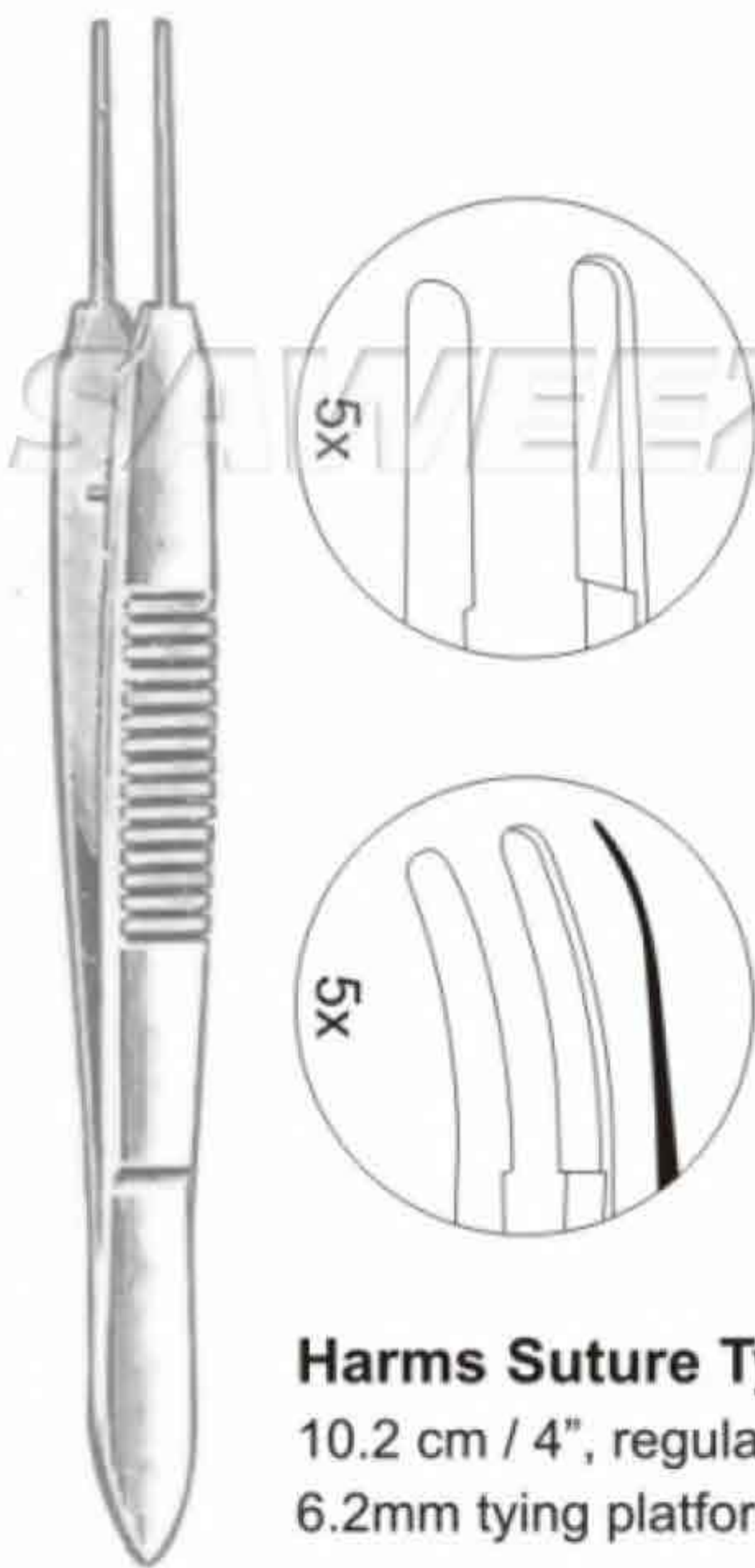
SAWEEZ SAWEEZ SAWEEZ SAWEEZ



Mccullough Utility Forceps
10.2 cm / 4", cross-serrated
1 x 2 teeth
SSC-55-11-74

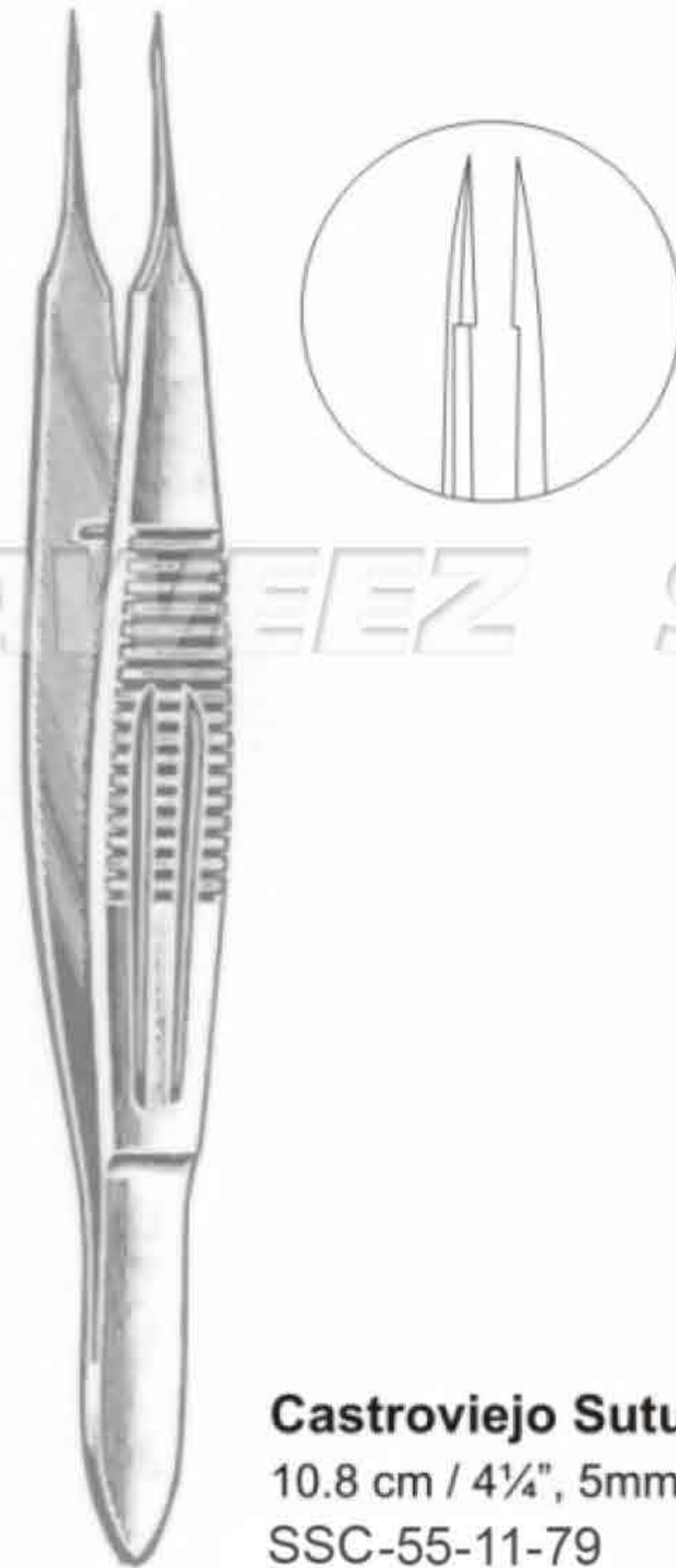


Harms Suture Tying Forceps
10.8 cm / 4¼", wide handle,
6.5mm tying platform
SSC-55-11-75 - Straight
SSC-55-11-76 - Curved

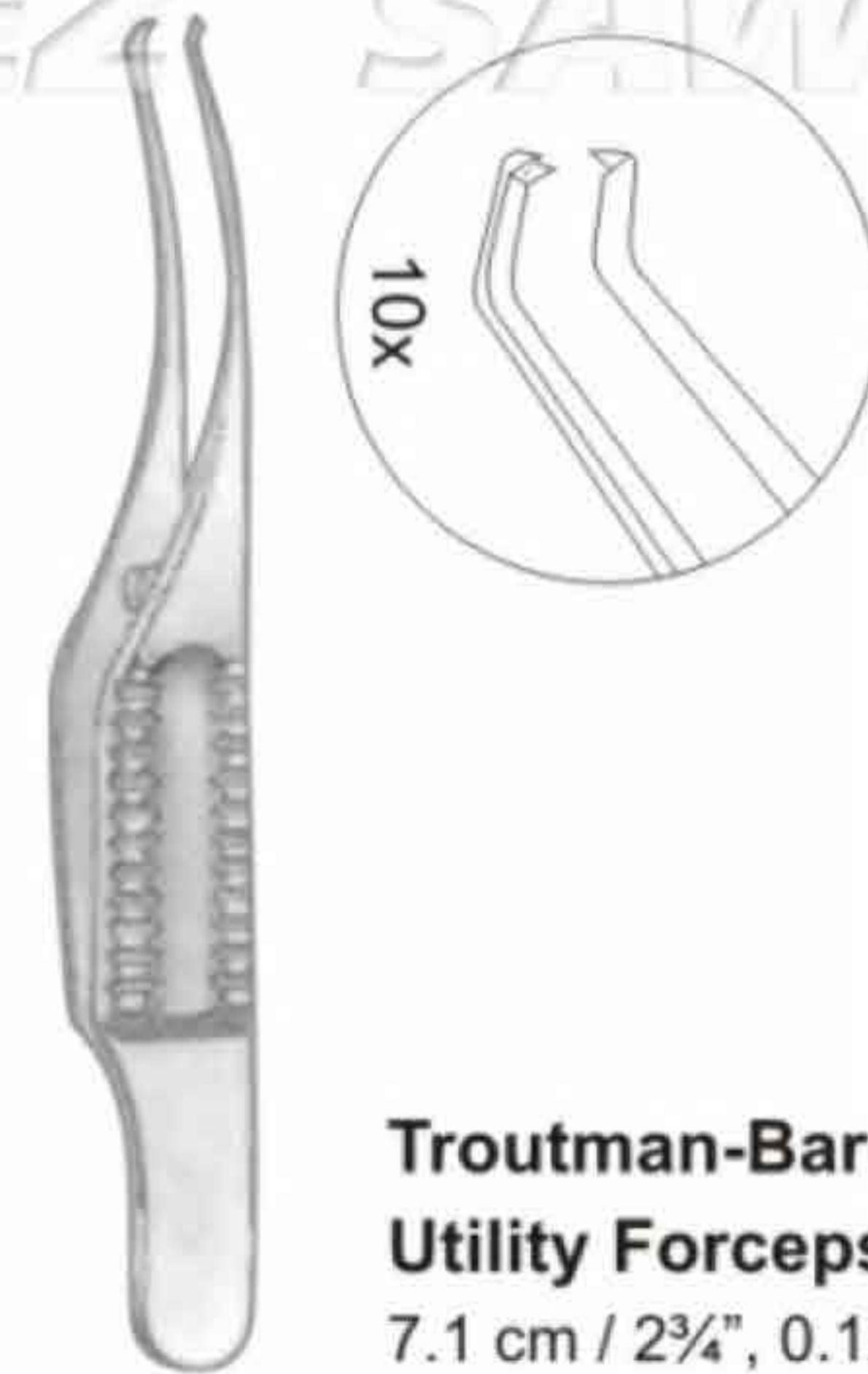


Harms Suture Tying Forceps
10.2 cm / 4", regular handle,
6.2mm tying platform

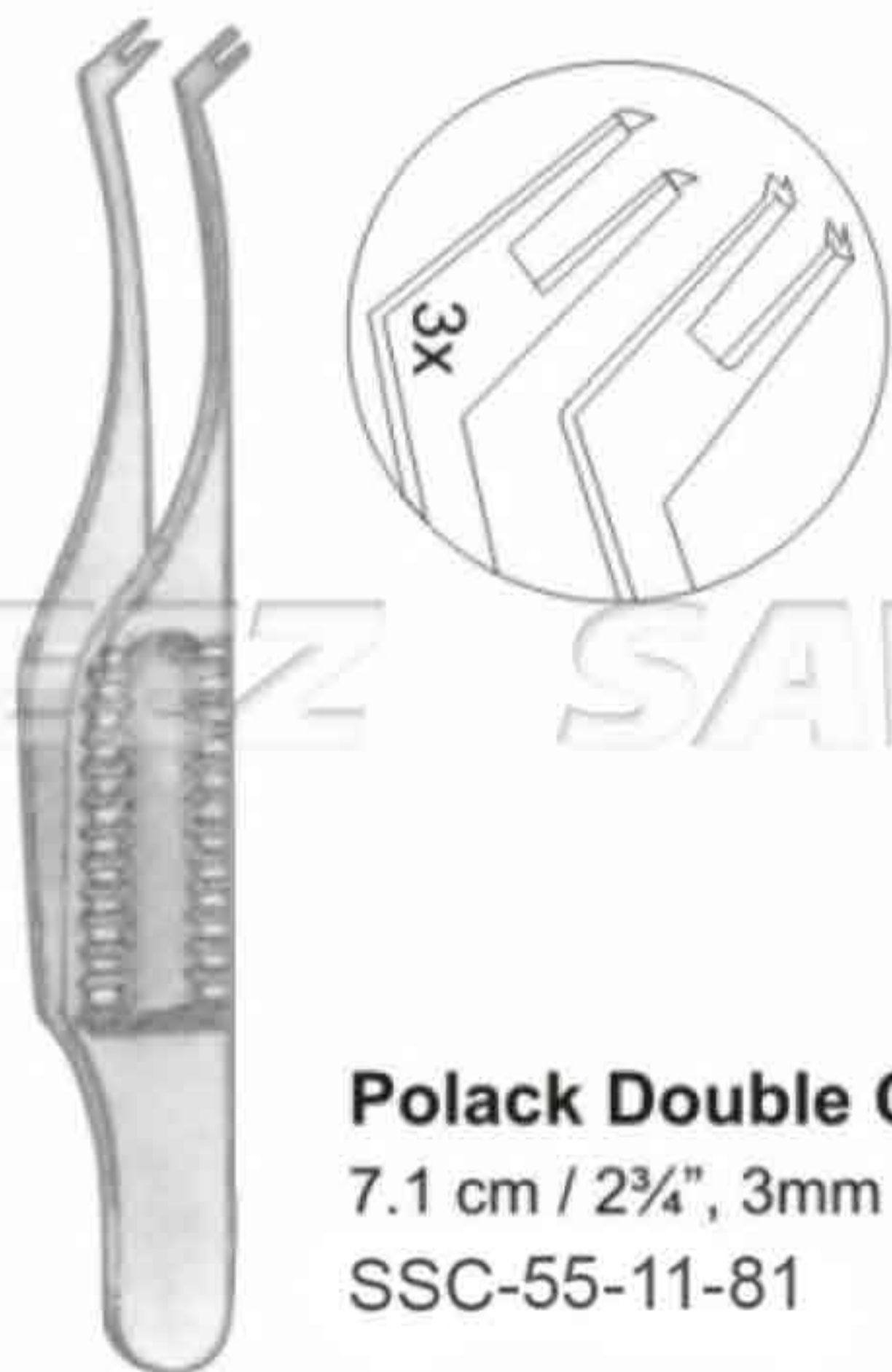
SSC-55-11-77 - Straight
SSC-55-11-78 - Curved



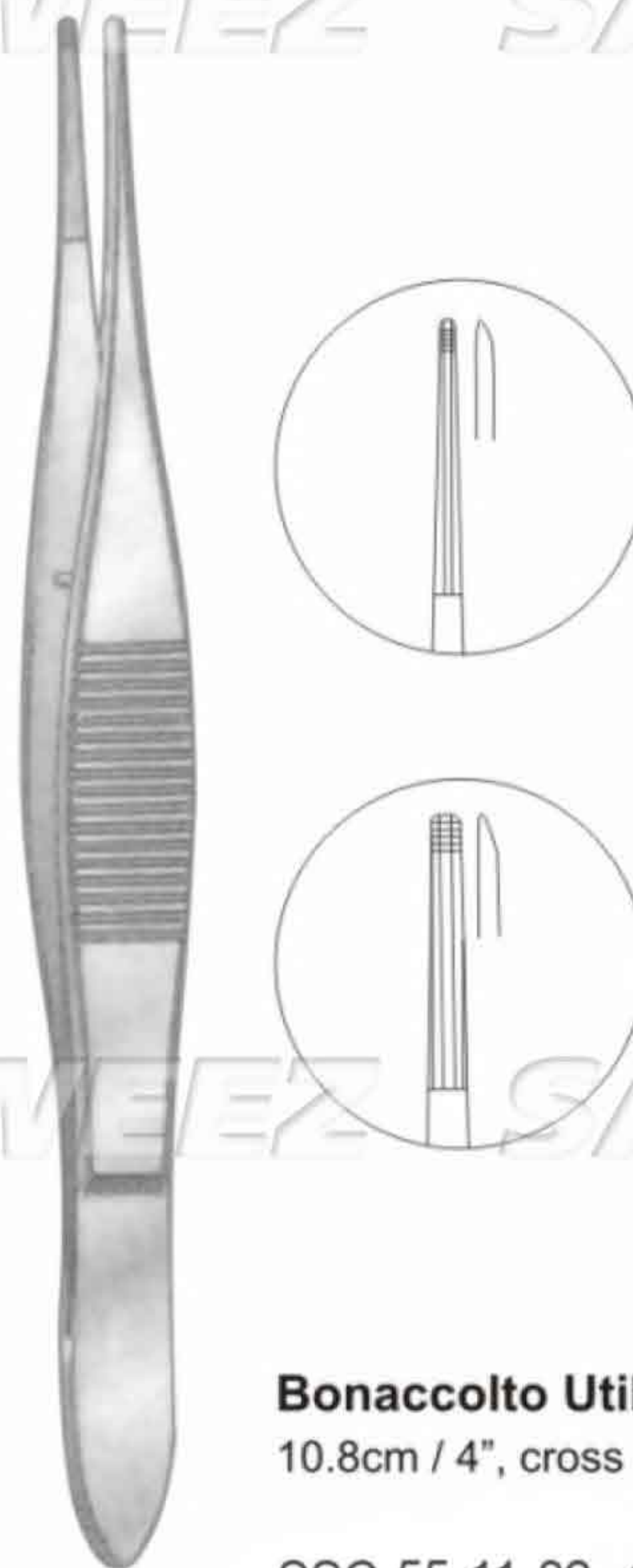
Castroviejo Suture Tying Forceps
10.8 cm / 4¼", 5mm tying platform
SSC-55-11-79



Troutman-Barraquer Corneal Utility Forceps (Colibri-Type)
7.1 cm / 2¾", 0.12mm teeth
SSC-55-11-80

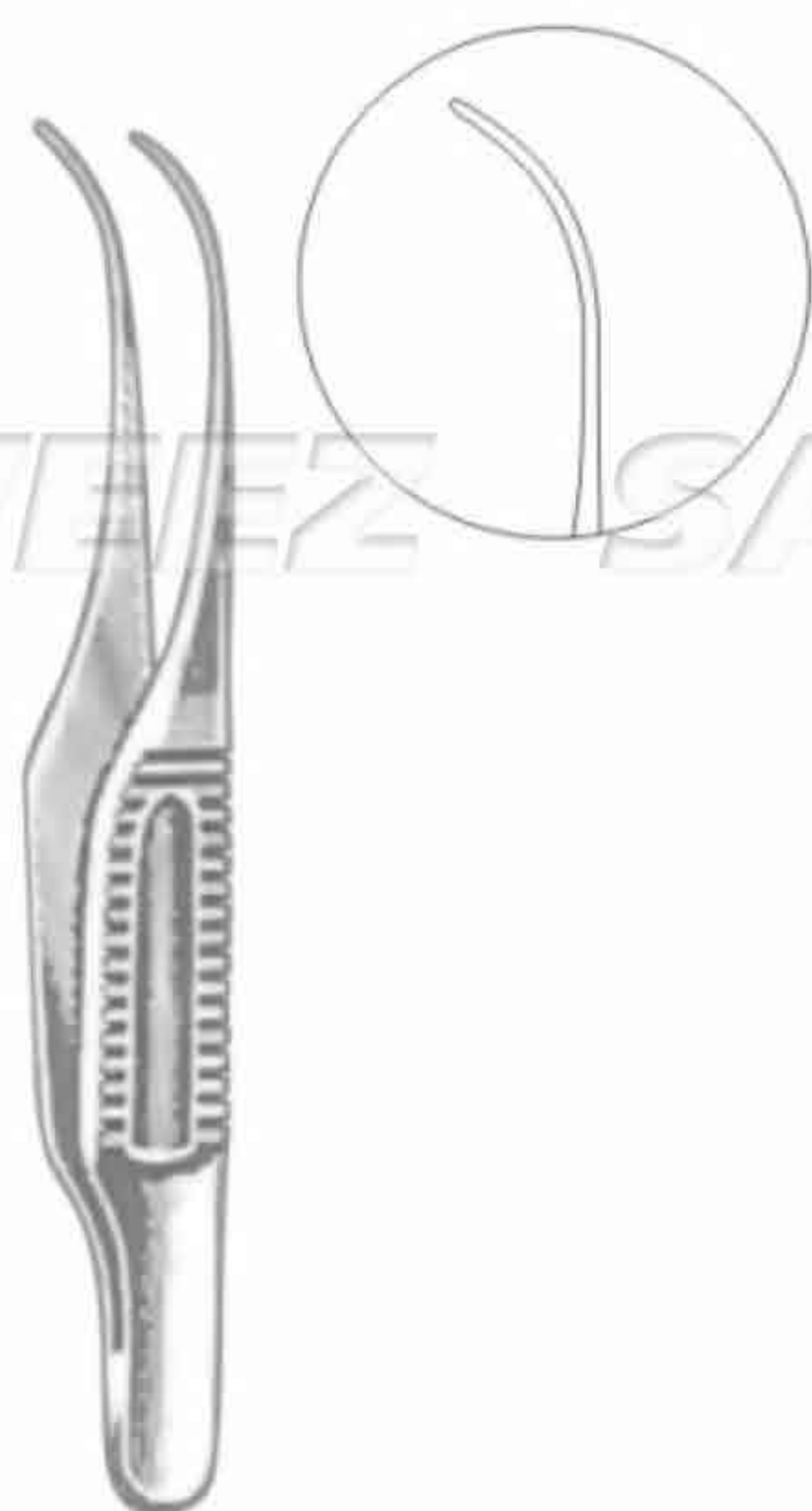


Polack Double Corneal Forceps (Colibri-Type)
7.1 cm / 2¾", 3mm long tips with 1 x 2 teeth
SSC-55-11-81

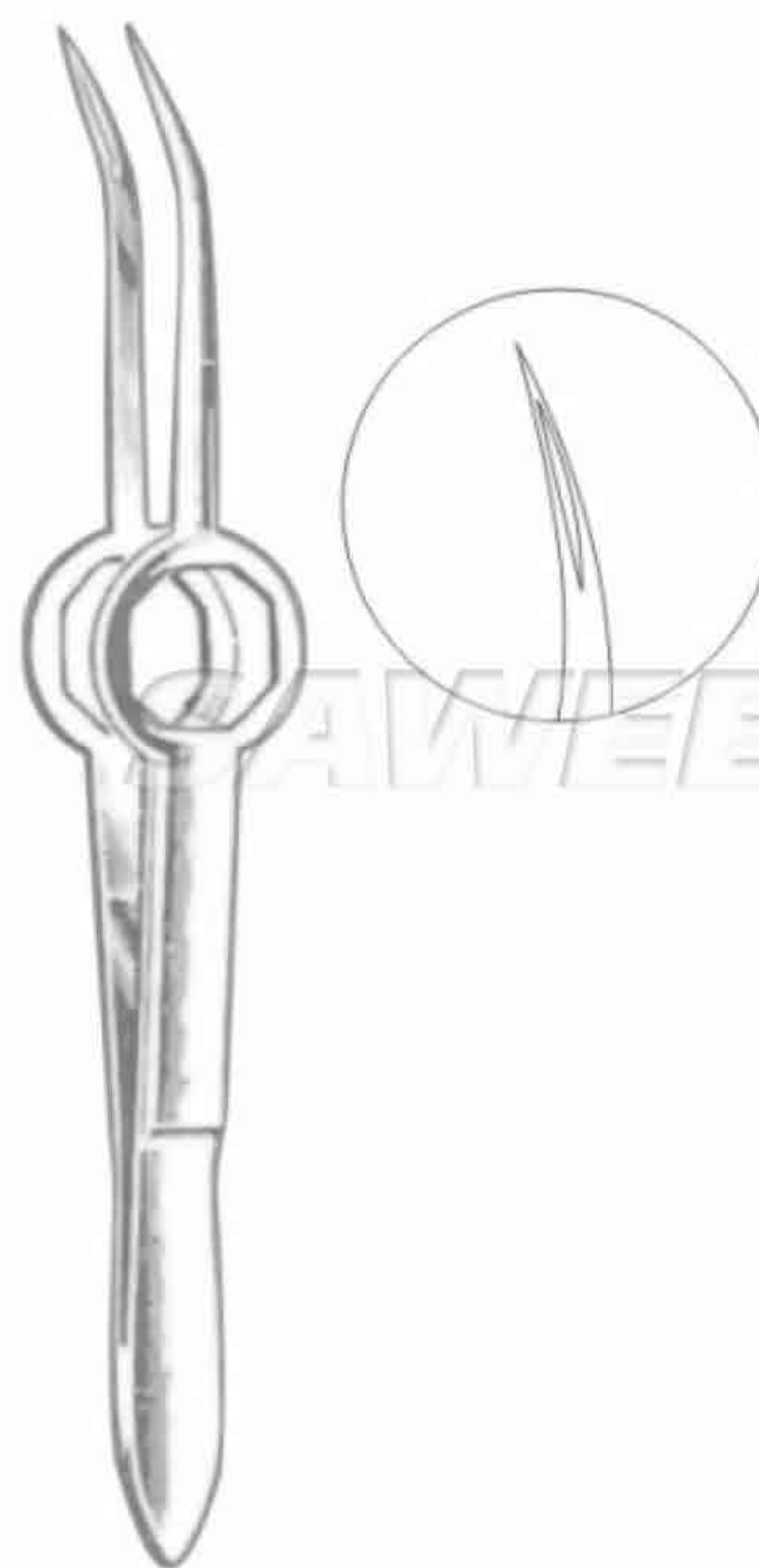


Bonaccolto Utility Forceps
10.8cm / 4", cross serrated

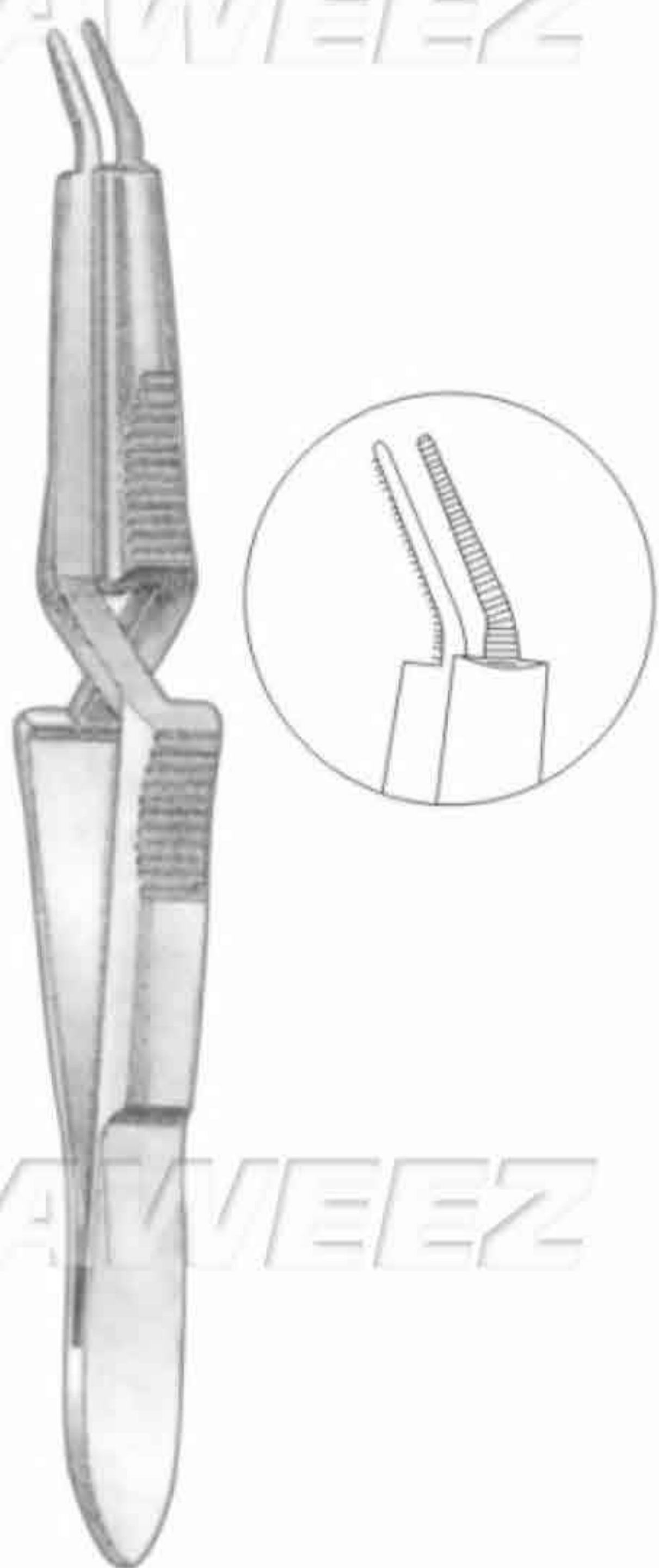
SSC-55-11-82- 1.2mm wide platform
SSC-55-11-83- 1.7mm wide platform



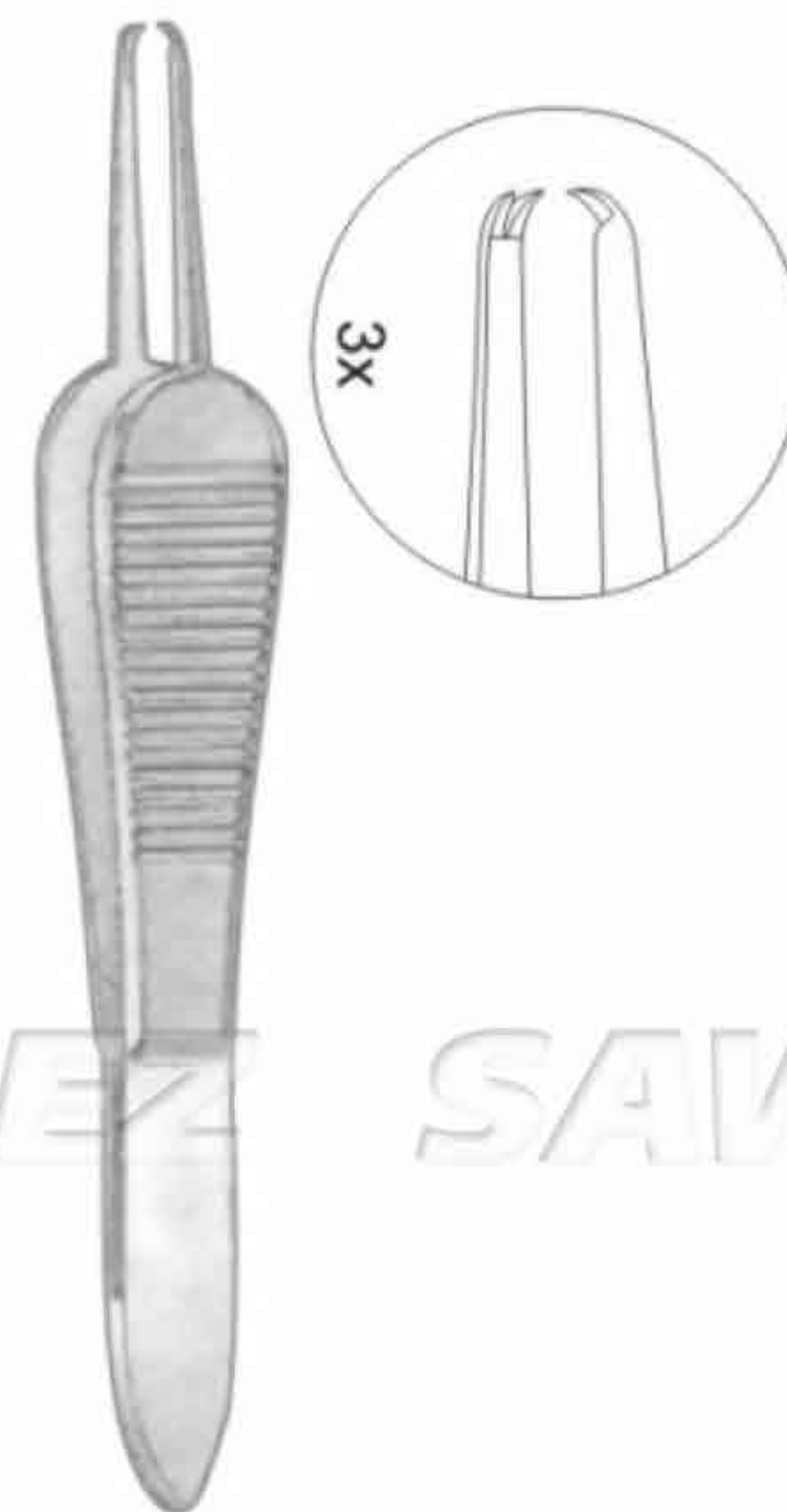
Chandler Iris Forceps
7.6 cm / 3"
SSC-55-11-84



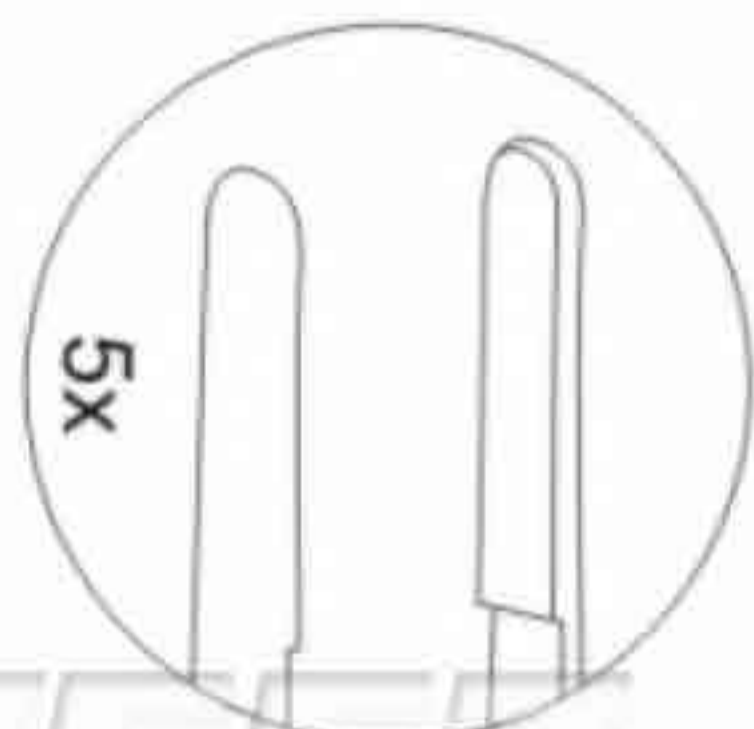
Schaaf Foreign Body Forceps
8.9 cm / 3½"
SSC-55-11-85



Watzke Sleeve Spreading Forceps
11.4 cm / 4½", cross-action,
10mm serrated angled tips
SSC-55-11-86



Sauer Suture Forceps
8.9 cm / 3½", 1x2 teeth
SSC-55-11-87



Mcpherson Suture Tying Forceps

8.9 cm / 3½", straight,
4.5mm tying platform
SSC-55-11-88



Mcpherson Suture Tying Forceps

8.9 cm / 3½", angled,
4.5mm tying platform
SSC-55-11-89



Mcpherson Micro Corneal Forceps

8.9 cm / 3½", straight, 1x2 teeth,
4.5mm tying platform
SSC-55-11-90



Mcpherson Micro Corneal Forceps

8.9 cm / 3½", angled,
1x2 teeth, 4.5mm tying platform
SSC-55-11-91



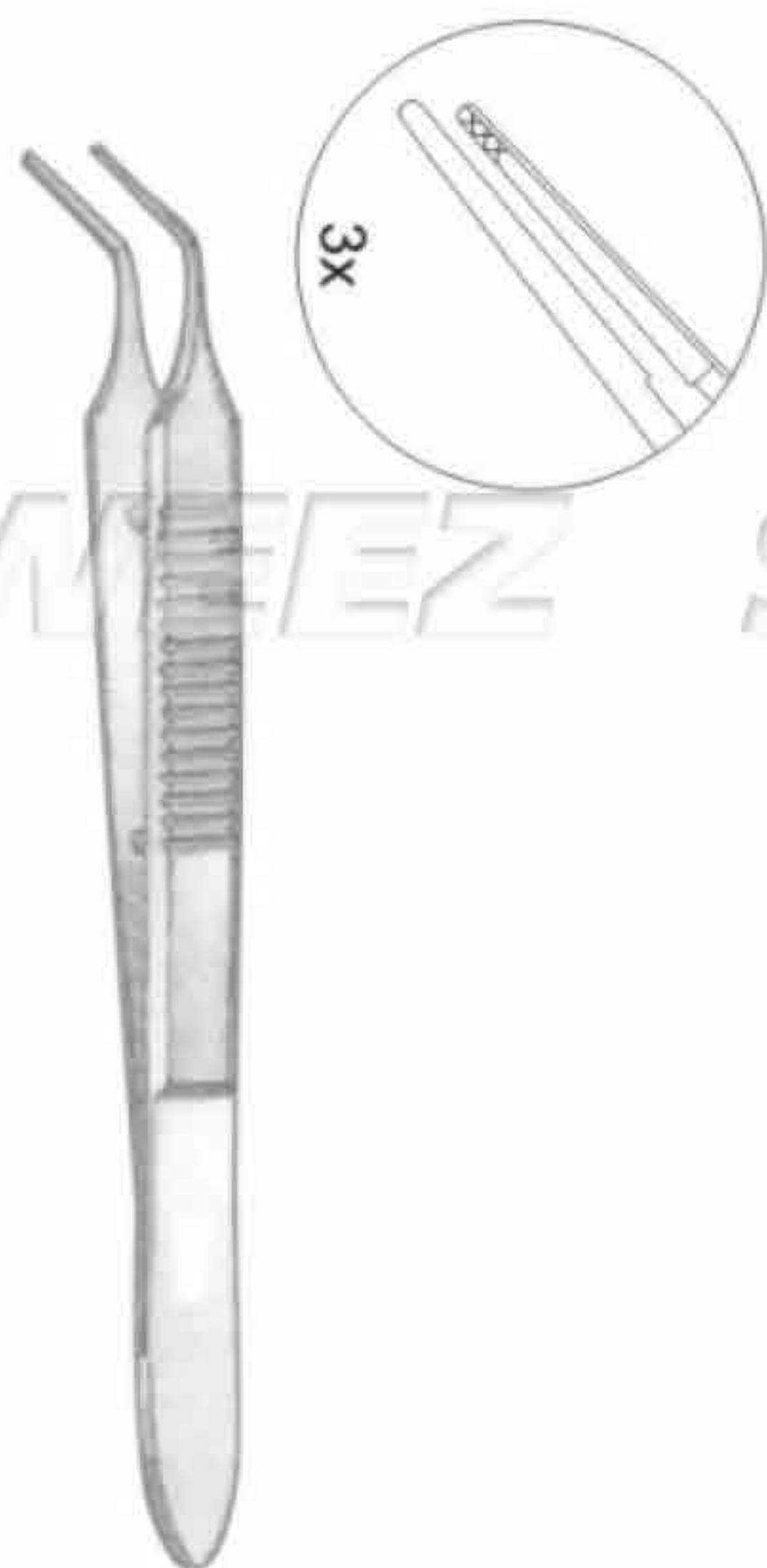
Kelman-Mcpherson Suture Tying Forceps

8.6 cm / 3⅜", angled,
7mm tying platform
SSC-55-11-92



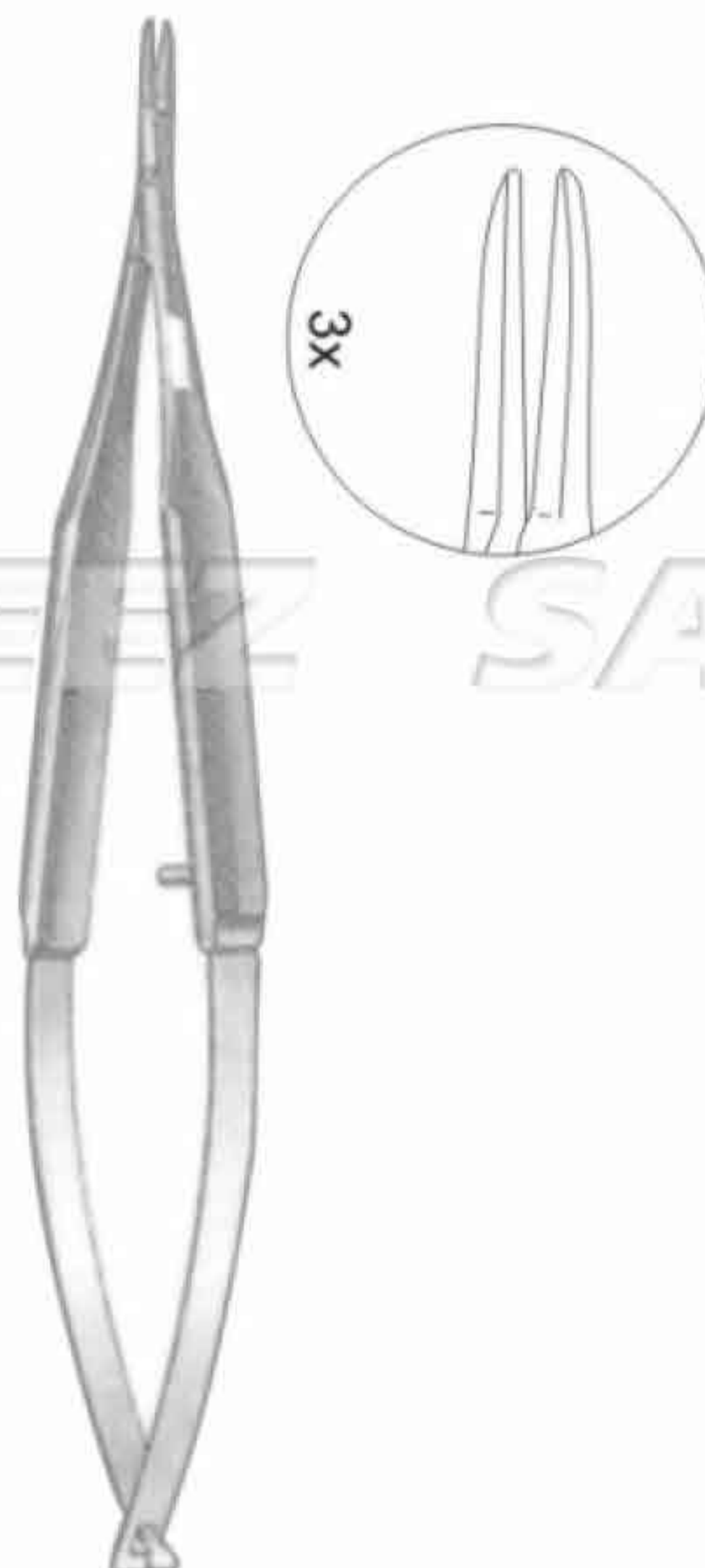
Kelman-Mcpherson Micro Corneal Forceps

8.6 cm / 3⅜", angled,
1x2 teeth, 7mm tying platform
SSC-55-11-93



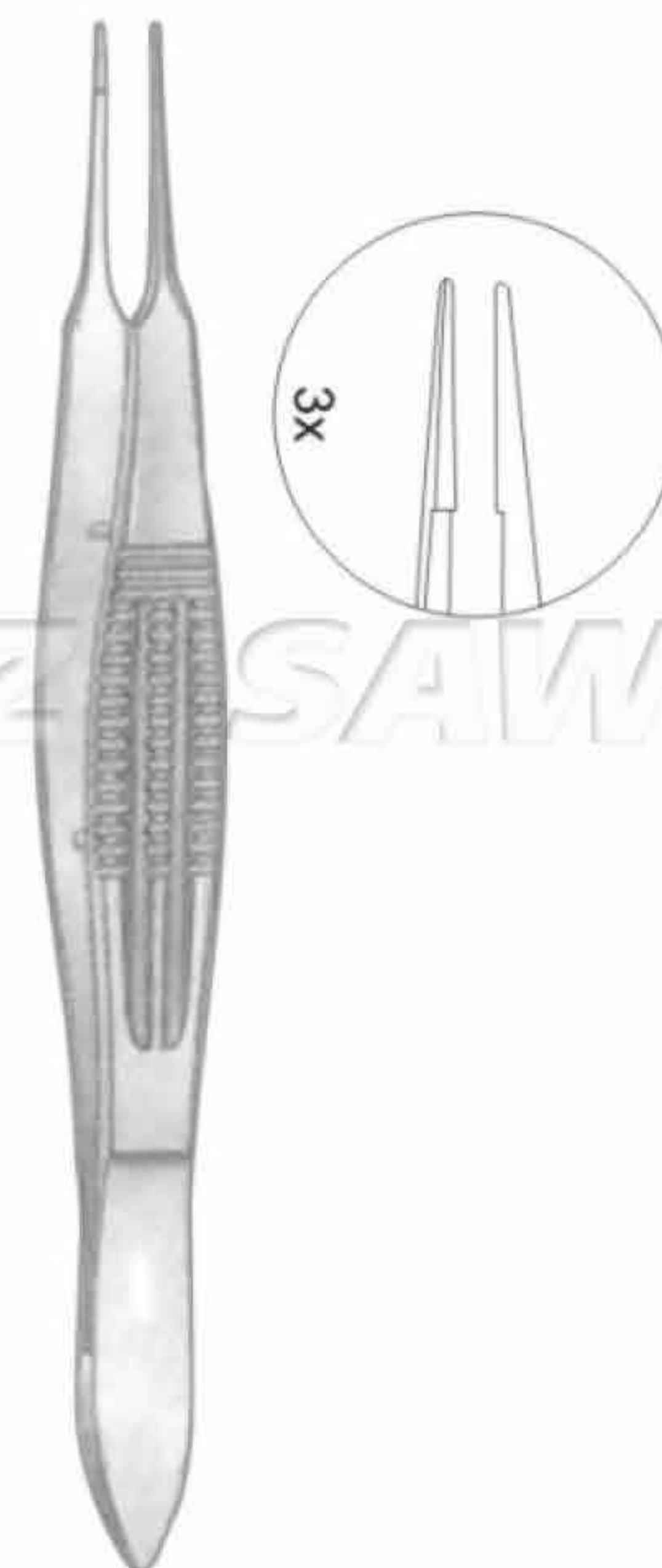
Sheets-Mcpherson Tying Forceps

8.3cm / 3¼", 45° angled jaws,
1mm cross-serrated tips,
10.5mm tying platform
SSC-55-11-94



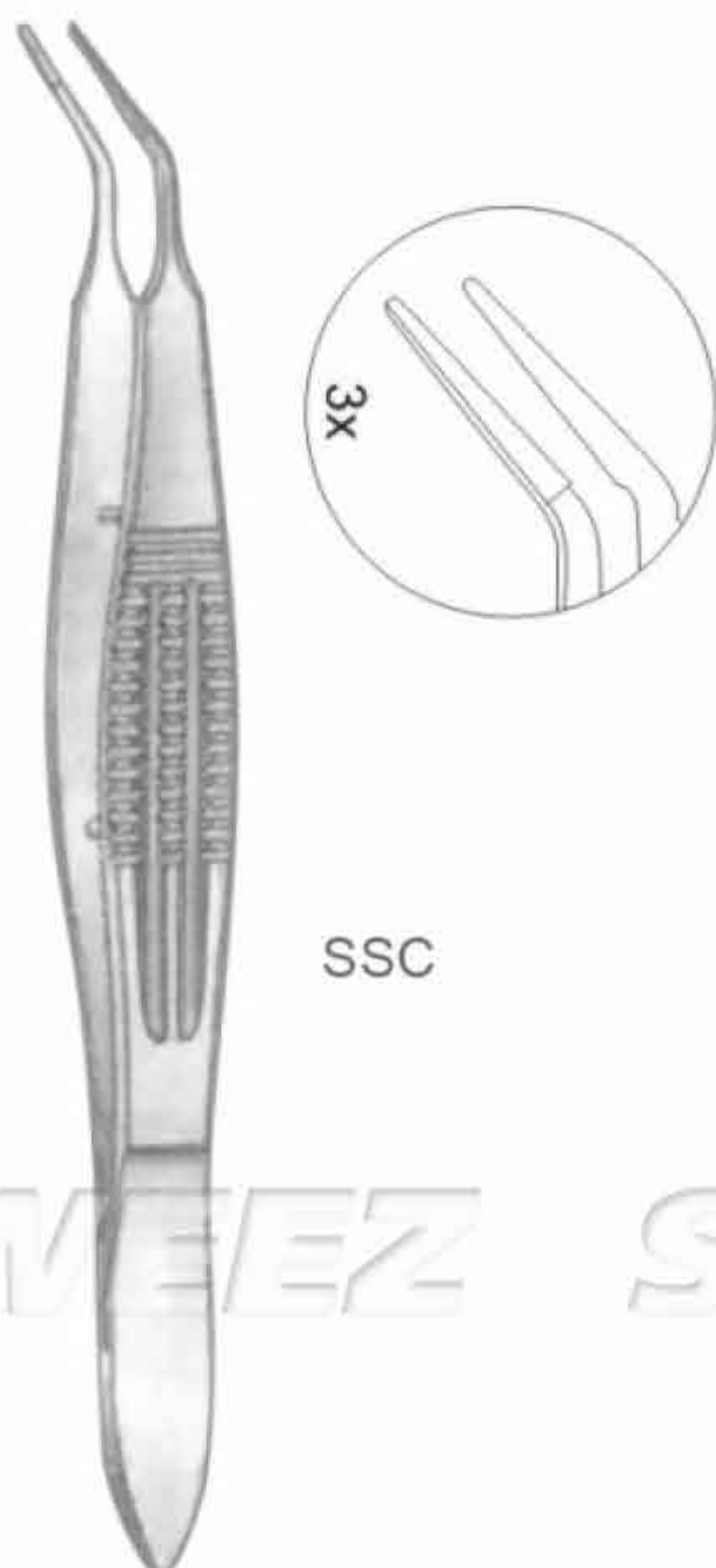
Sinsky Tying Forceps

11.1cm / 4¾", straight,
7mm tying platform
SSC-55-11-95



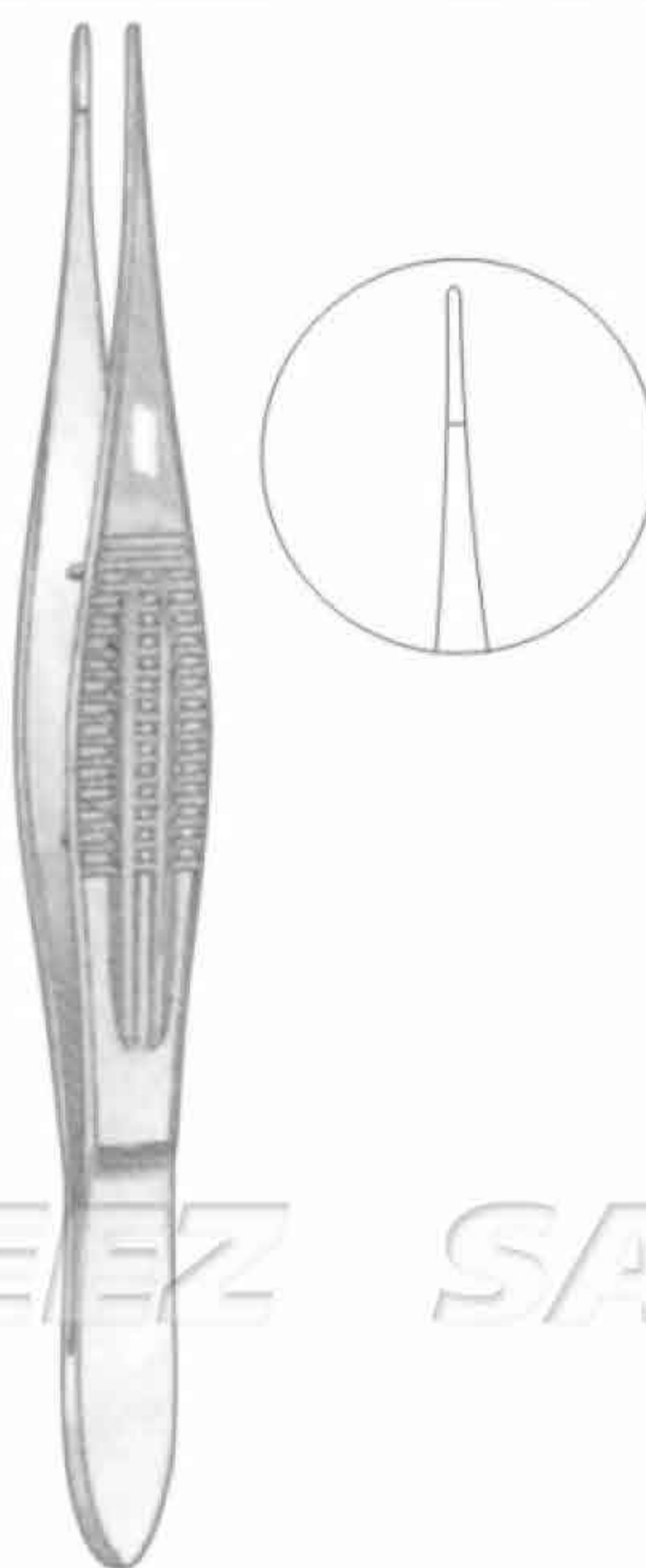
Shepard Tying Forceps

10.8cm / 4¼", straight,
wide handle, 4mm tying
platform
SSC-55-11-96



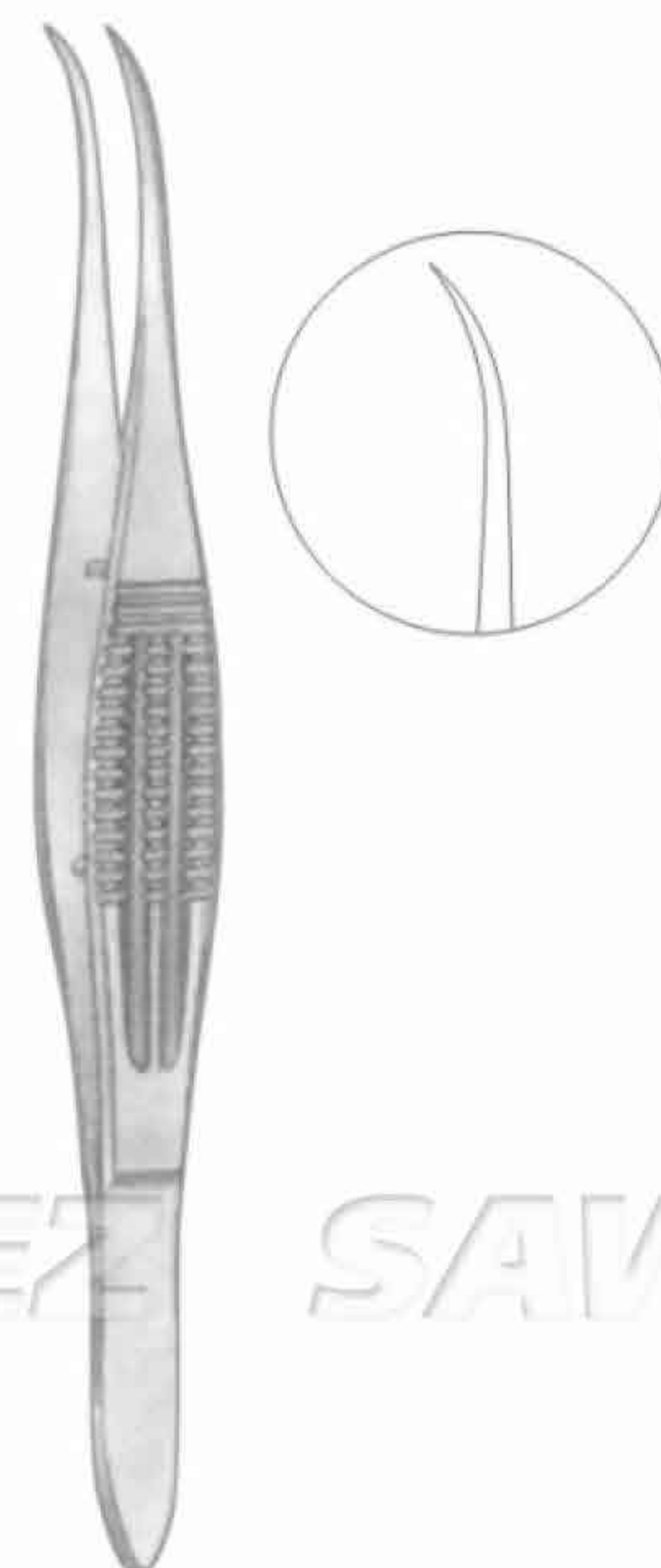
Shepard Tying Forceps

10.8cm / 4¼", 45° angle,
wide handle,
4mm tying platform
SSC-55-11-97



Tying Forceps

10.8cm / 4¼",
wide handle,
4mm tying platform
SSC-55-11-98



Fine Tying Forceps

10.8cm / 4¼",
wide handle,
curved tips with tying surface
SSC-55-11-99



Ziegler Cilia Forceps
8.6cm / 3 1/4"
SSC-55-12-00



Littauer Cilia Forceps
8.3cm / 3 1/4"
SSC-55-12-01



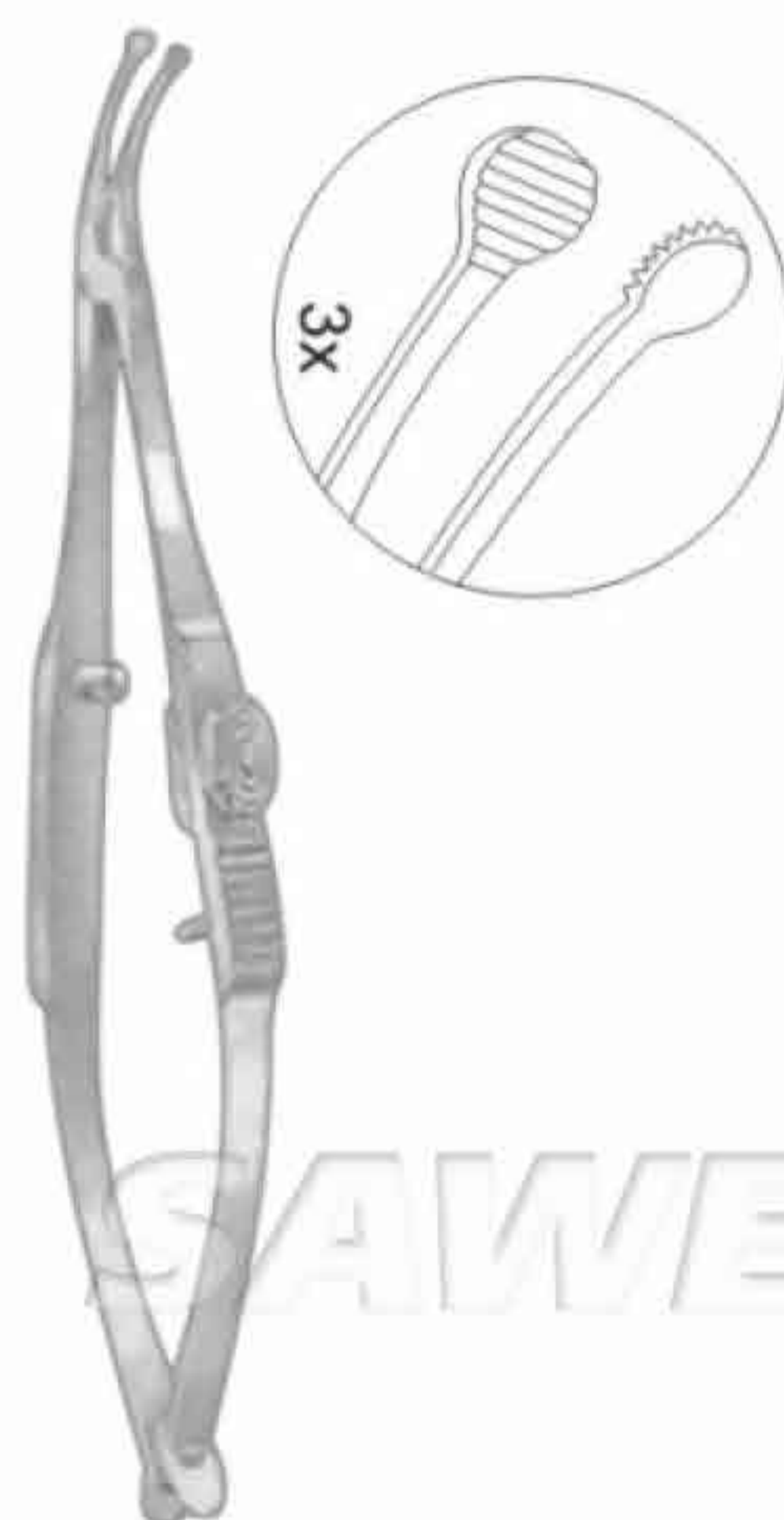
Douglas Cilia Forceps
8.9cm / 3 1/2"
SSC-55-12-02



Gradle Cilia Forceps
9.8 cm / 3 7/8"
2mm wide platform
SSC-55-12-03



Barraquer Cilia Forceps
10.2 cm / 4"
6mm long platform
SSC-55-12-04



Shepard Intraocular Lens Forceps
9.2 cm / 3 5/8", curved shafts,
slide lock,
1.5mm upper and
2mm lower serrated jaws
SSC-55-12-05



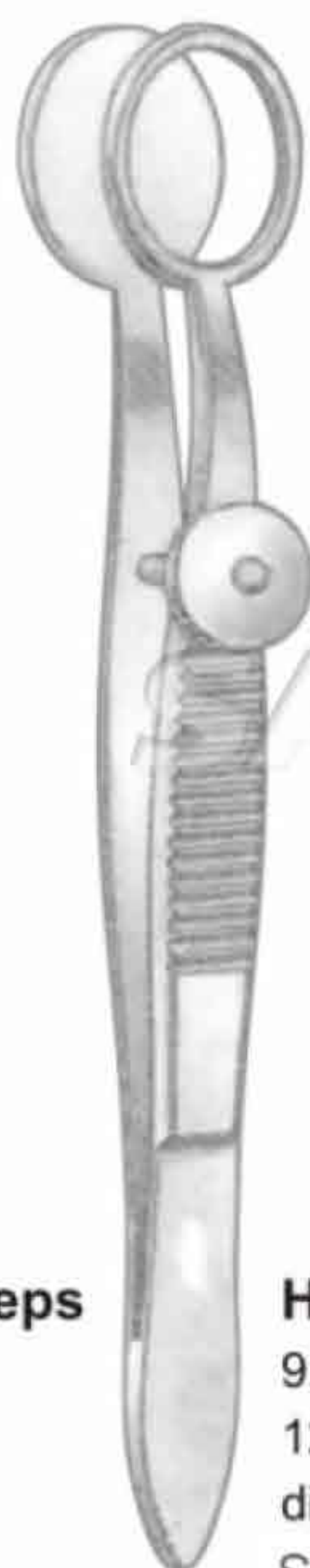
Clayman Lens Forceps
12.0 cm / 4 1/2", curved shafts,
3mm angled tips
SSC-55-12-06



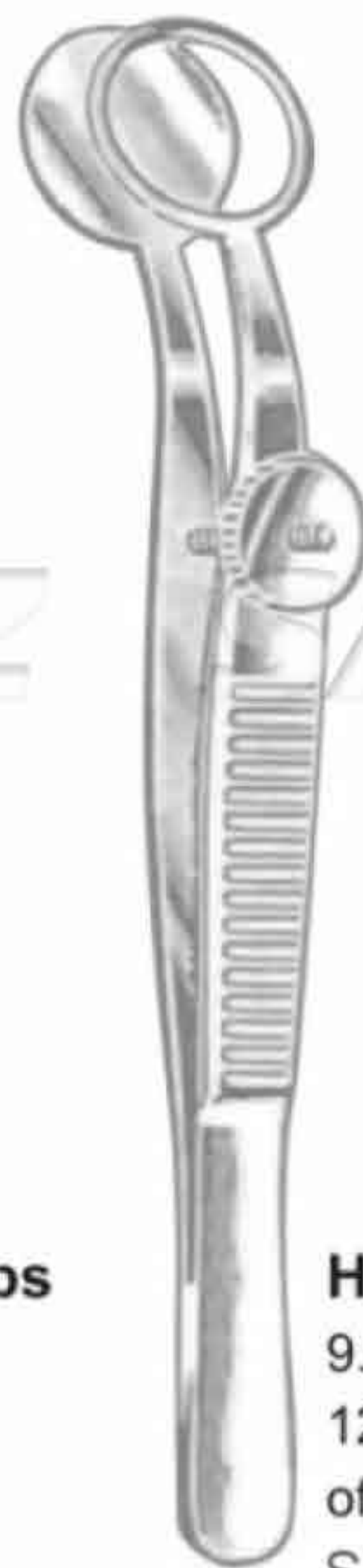
Thornton Intraocular Lens Forceps
8.6 cm / 3 3/8",
11mm angled jaws 45°
SSC-55-12-07



Lambert Chalazion Forceps
9.2 cm / 3 $\frac{3}{8}$ ",
8mm inside diameter
of fenestrated jaw
SSC-55-12-08



Heath Chalazion Forceps
9.5 cm / 3 $\frac{3}{4}$ ",
12mm x 14mm inside
diameter of fenestrated jaw
SSC-55-12-09



Hunt Chalazion Forceps
9.5 cm / 3 $\frac{3}{4}$ ",
12mm inside diameter
of fenestrated jaw
SSC-55-12-10



Desmarres Chalazion Forceps
8.9 cm / 3 $\frac{1}{2}$ "
SSC-55-12-11 11mm x 17mm inside
diameter of
fenestrated jaw
SSC-55-12-12 11.5mm x 22.5mm
inside diameter of
fenestrated jaw
SSC-55-12-13 16.5mm x 28mm
inside diameter of
fenestrated jaw



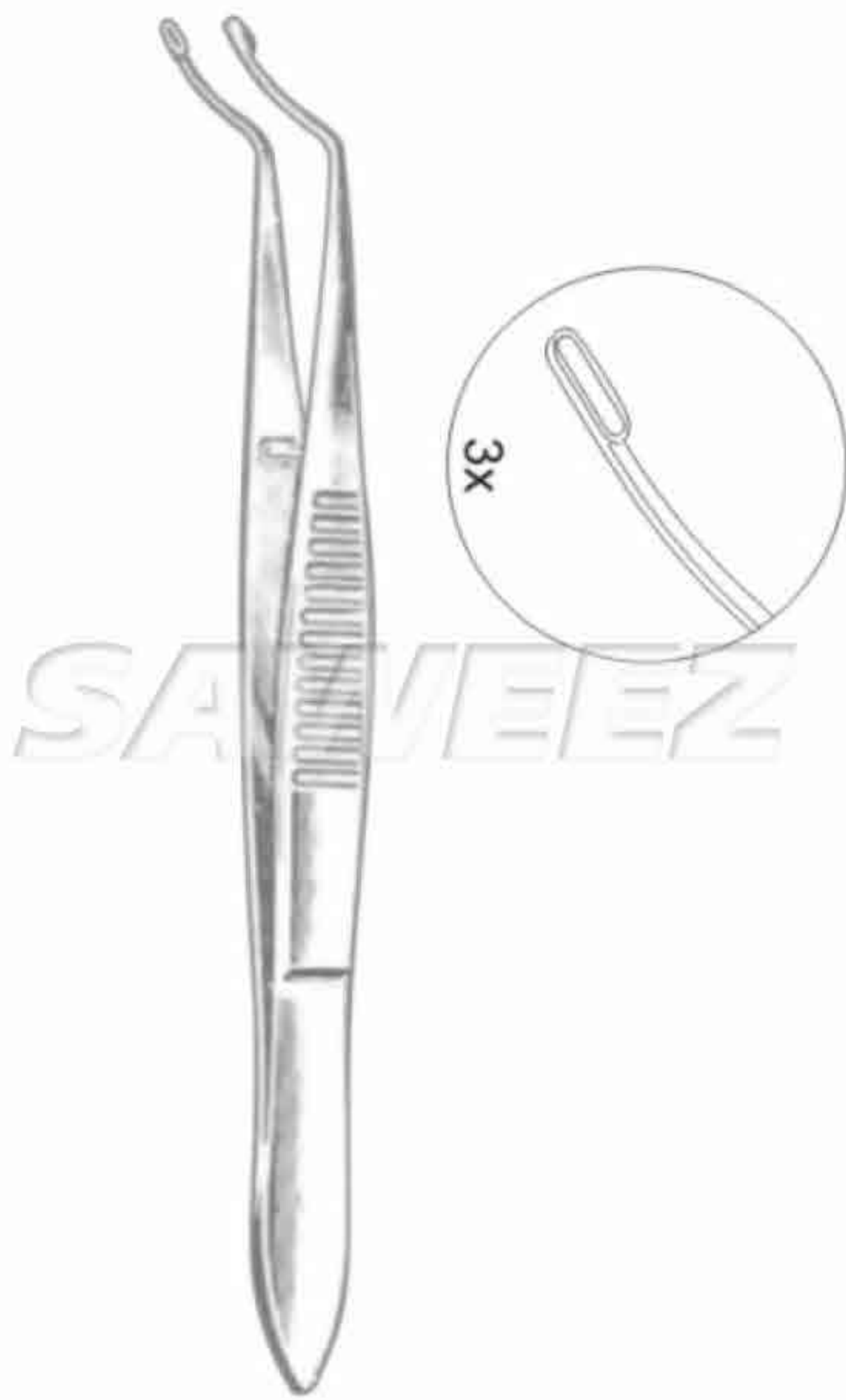
Lordan Chalazion Forceps
9.5 cm / 3 $\frac{3}{4}$ ",
7.5x12mm inside dimensions
of fenestrated jaw
SSC-55-12-14



Francis Chalazion Forceps
9.5 cm / 3 $\frac{3}{4}$ ",
12x14mm inside diameter
of fenestrated jaw
SSC-55-12-15



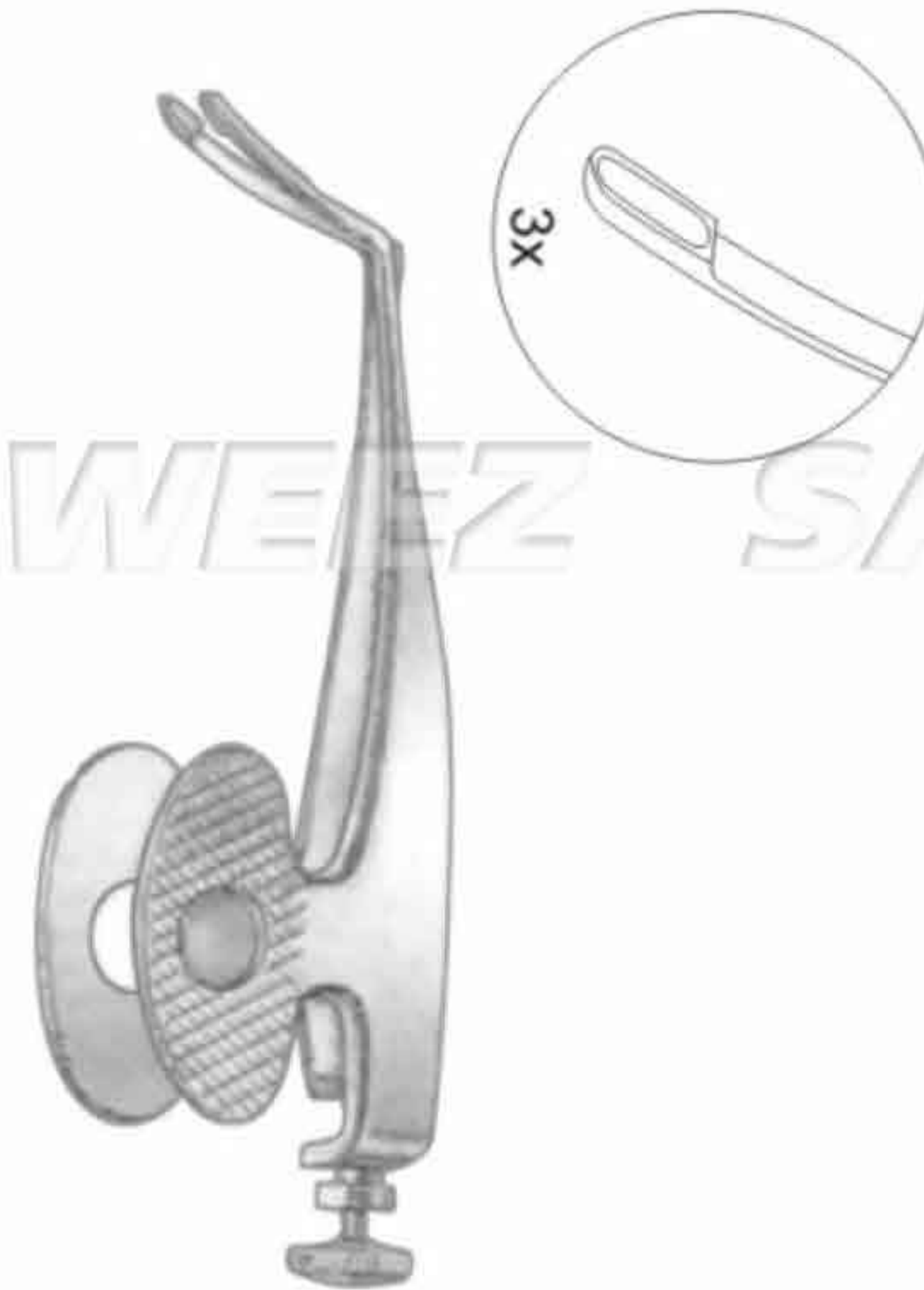
Snellen Entropium Forceps
8.9 cm / 3 $\frac{1}{2}$ ", 35mm
wide solid plate
SSC-55-12-16 - Left
SSC-55-12-17 - Right (Illustrated)



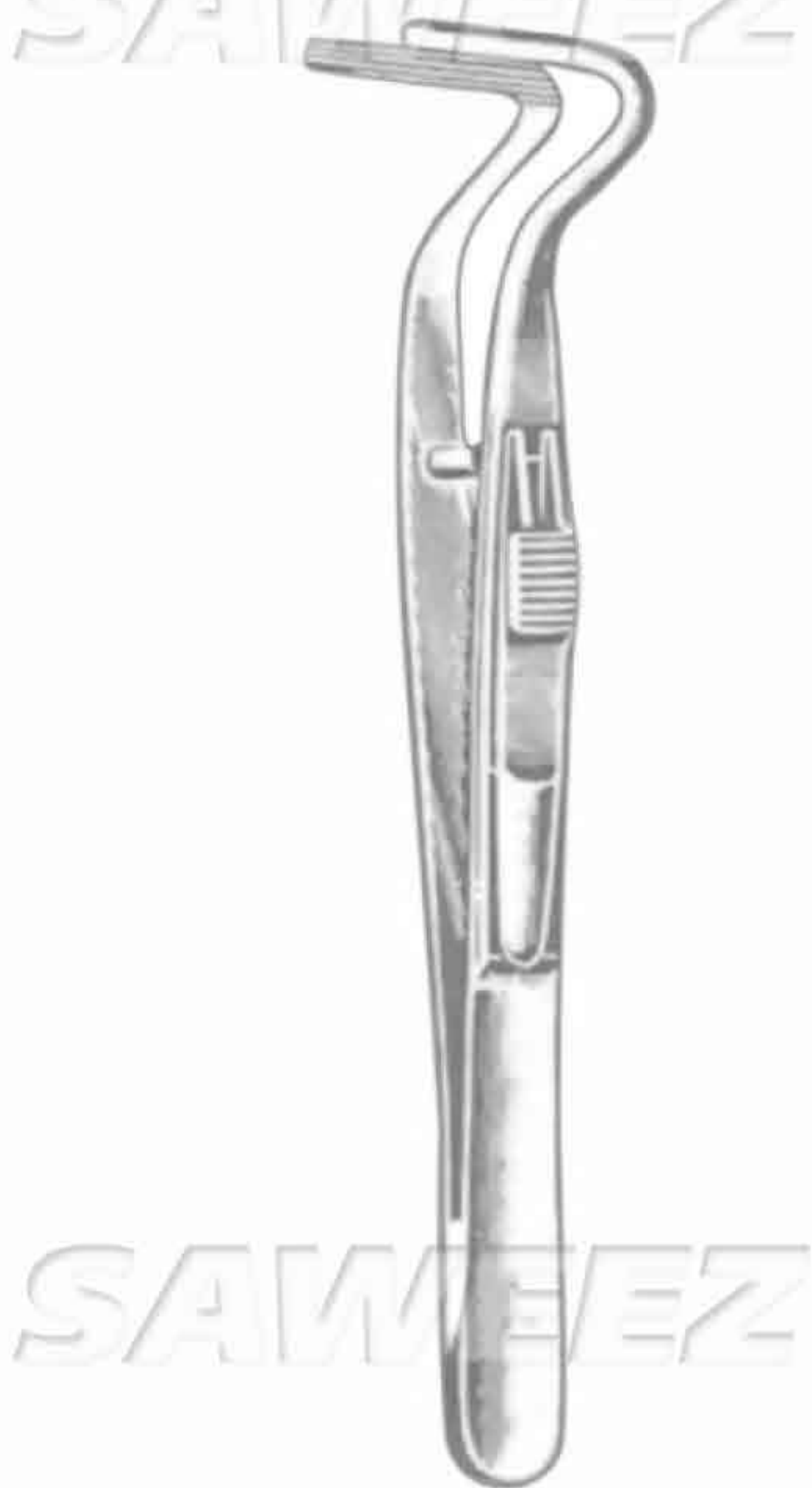
Arruga Capsule Forceps
10.2 cm / 4"
SSC-55-12-18



Castroviejo Capsule Forceps
10.2 cm / 4", cross action
SSC-55-12-19



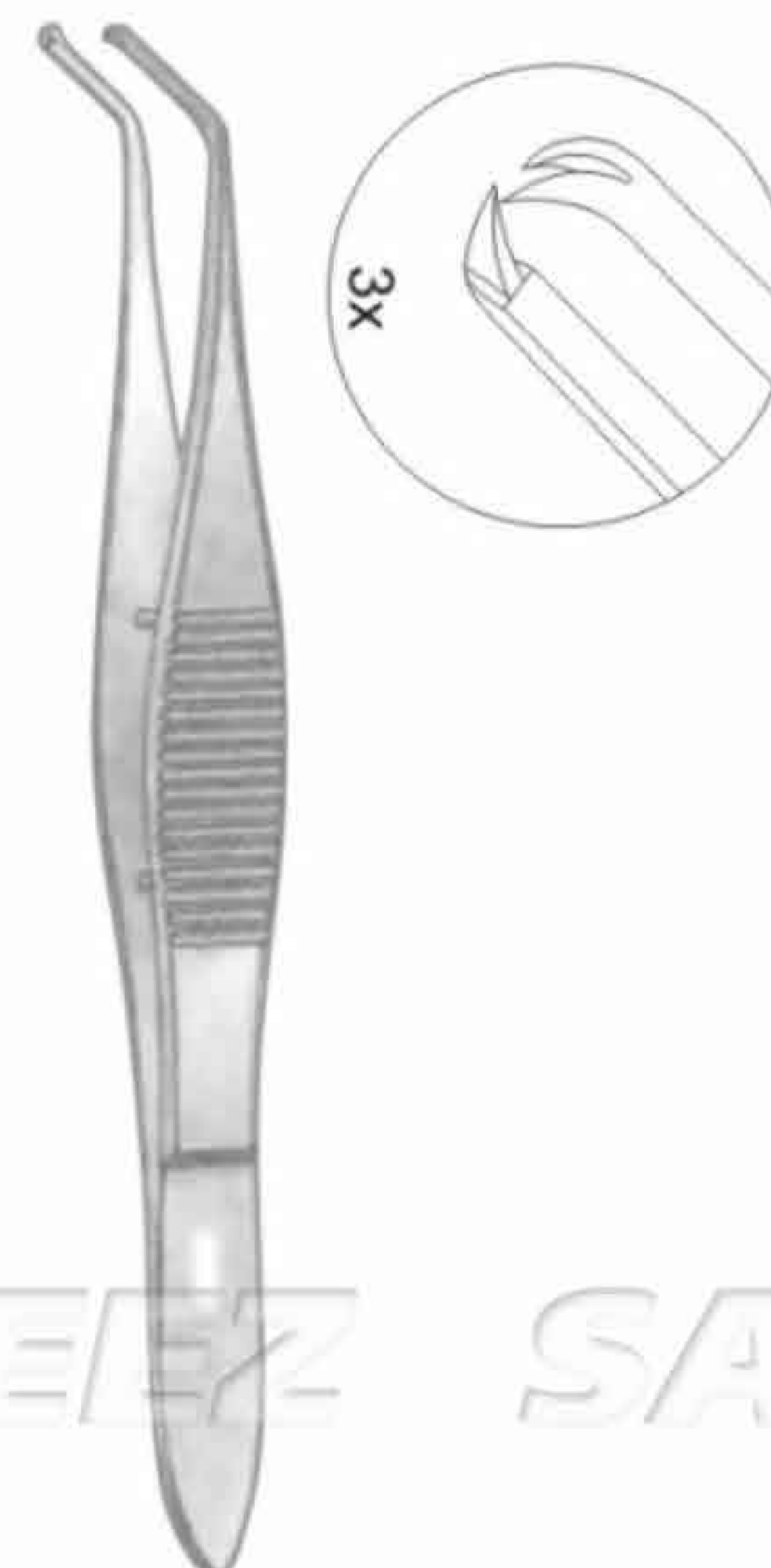
Capsule Fragment and Clot Forceps
5.6 cm / 2¼", 2mm platform and
microscopic cups on inner jaw surface
SSC-55-12-20



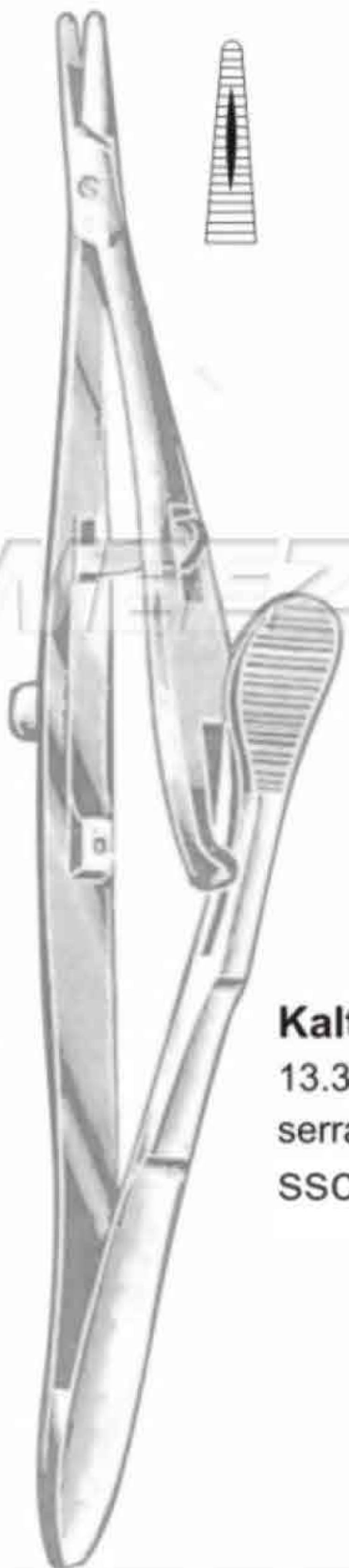
Beerke Ptosis Clamp
10.2 cm / 4", 20mm jaw
SSC-55-12-21



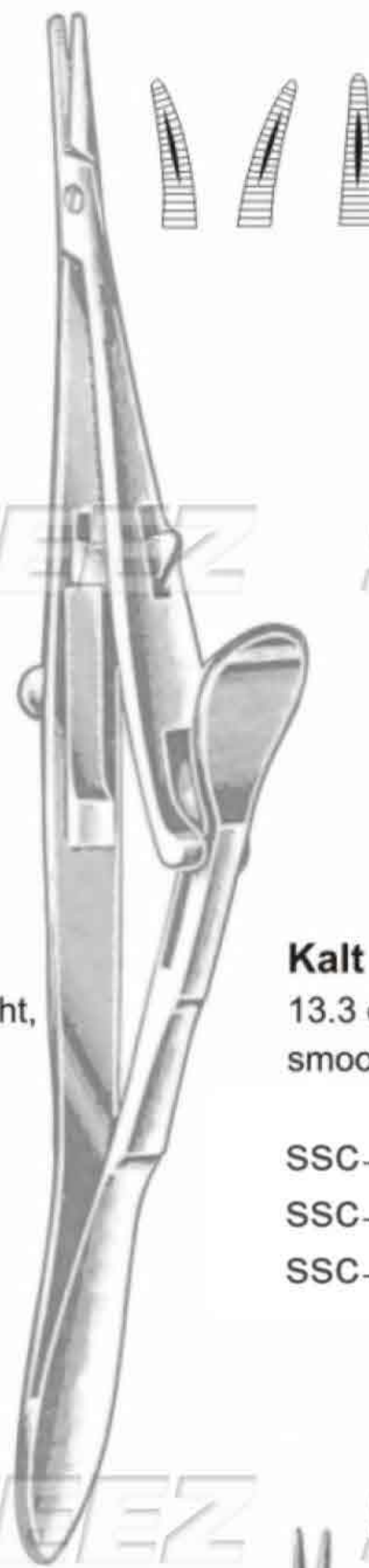
Jameson Muscle Recession Forceps
10.2 cm / 4"
SSC-55-12-22 Left, 12mm jaws, (illustrated)
SSC-55-12-23 Left, 7mm jaws
SSC-55-12-24 Right, 12mm jaws
SSC-55-12-25 Right, 7mm jaws



Troutman Superior Rectus Forceps
10.5 cm / 4⅞",
45° angle, 10mm from tip to bend
SSC-55-12-26



Kalt Needle Holder
13.3 cm / 5¼", 12mm jaws, straight,
serrated thumb plate with lock
SSC-55-12-27



Kalt Needle Holders
13.3 cm / 5¼", 10mm jaws,
smooth, thumb plate with lock
SSC-55-12-28 Straight
SSC-55-12-29 Curved right
SSC-55-12-30 Curved left



Castroviejo Needle Holders
14.0 cm / 5½", 10mm smooth jaws,
flat serrated handle with lock
SSC-55-12-31 Straight
SSC-55-12-32 Curved



Castroviejo Needle Holders
13.0 cm / 5", 9mm smooth jaws,
wide serrated handle
SSC-55-12-33 Straight without lock
SSC-55-12-34 Curved without lock
SSC-55-12-35 Straight with lock
SSC-55-12-36 Curved with lock





Barraquer Needle Holders
13.3 cm / 5¼", 9mm curved jaws,
round knurled handle

- SSC-55-12-37 With lock
- SSC-55-12-38 Without lock



Barraquer Needle Holders
10.2 cm / 4", 10mm smooth jaws,
round knurled handle

- SSC-55-12-39 Straight, without lock
- SSC-55-12-40 Straight, with lock
- SSC-55-12-41 Curved, without lock
- SSC-55-12-42 Curved, with lock



Mcpherson Needle Holders
10.2 cm / 4", 10mm smooth jaws,
flat serrated handle

- SSC-55-12-43 Straight, without lock
- SSC-55-12-44 Straight, with lock
- SSC-55-12-45 Curved, without lock
- SSC-55-12-46 Curved, with lock



Anis Needle Holders
13.0 cm / 5", 8mm smooth jaws,
round knurled handle without lock

- SSC-55-12-47 Straight
- SSC-55-12-48 Curved



Anis Needle Holders
13.0 cm / 5", 8mm smooth jaws,
round knurled handle with lock

- SSC-55-12-49 Straight
- SSC-55-12-50 Curved



Cohan Miniature Needle Holders
10.4 cm / 4⅞", 8mm
smooth curved jaws,
round knurled handle

- SSC-55-12-51 without lock
- SSC-55-12-52 with lock



Troutman Needle Holders
11.7 cm / 4⅝", 10mm
smooth curved jaws,
round serrated handle
without lock

- SSC-55-12-53



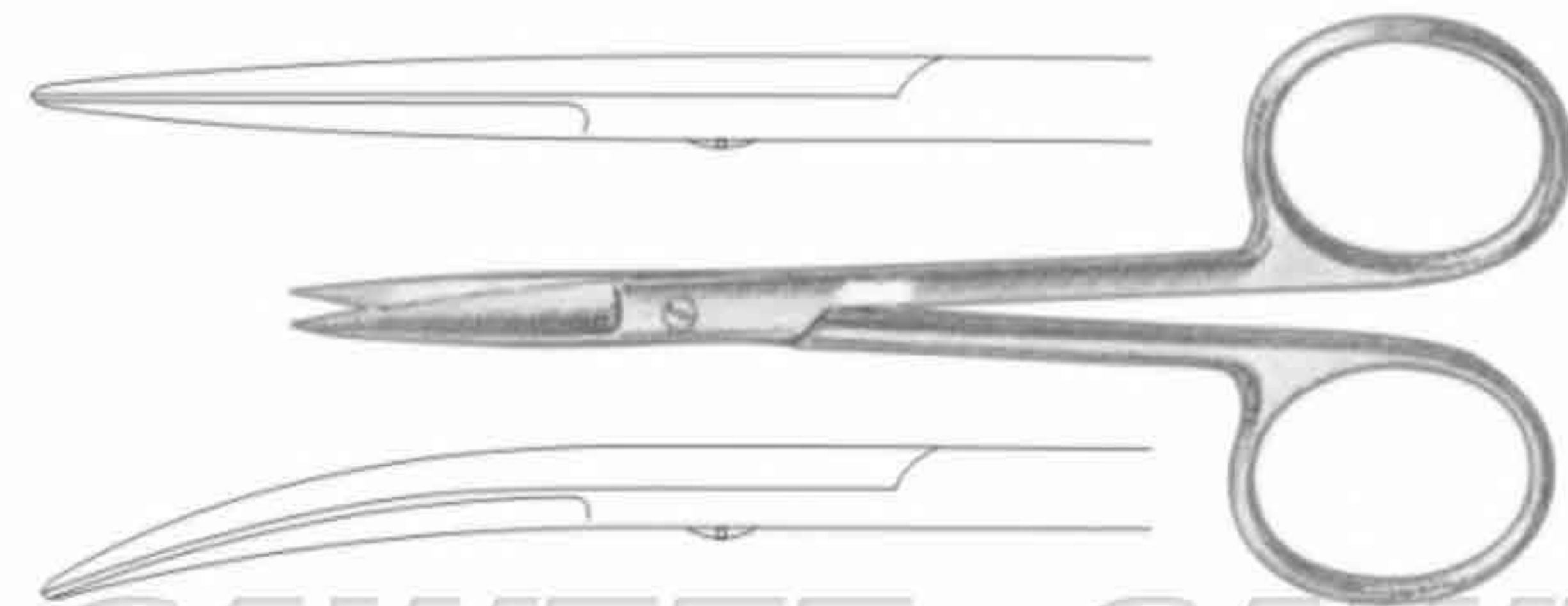
Knapp Iris Scissors

10.1 cm / 4", 25mm blades

SSC-55-12-54 Straight, sharp-sharp

SSC-55-12-55 Curved, sharp-sharp

SAWEEZ SAWEEZ



SAWEEZ SAWEEZ

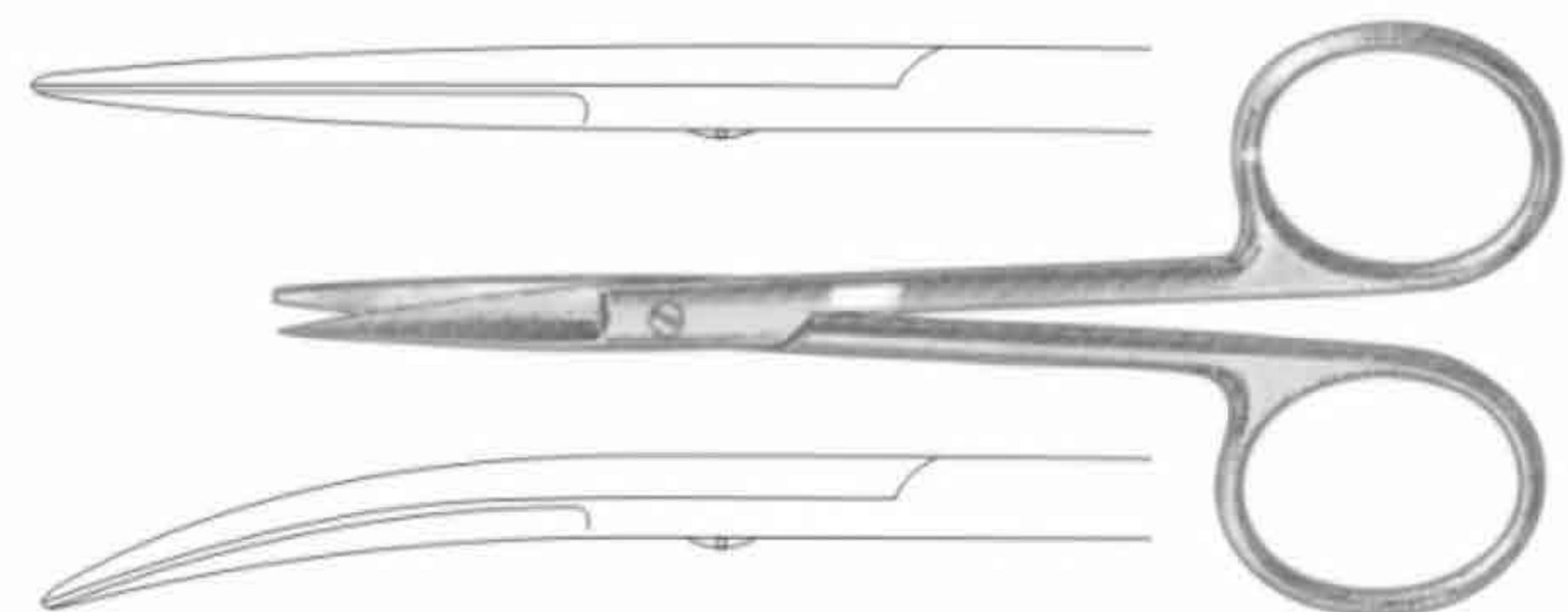
Knapp Iris Scissors

10.1 cm / 4", 25mm blades

SSC-55-12-56 Straight, sharp-blunt

SSC-55-12-57 Curved, sharp-blunt

SAWEEZ SAWEEZ



SAWEEZ SAWEEZ

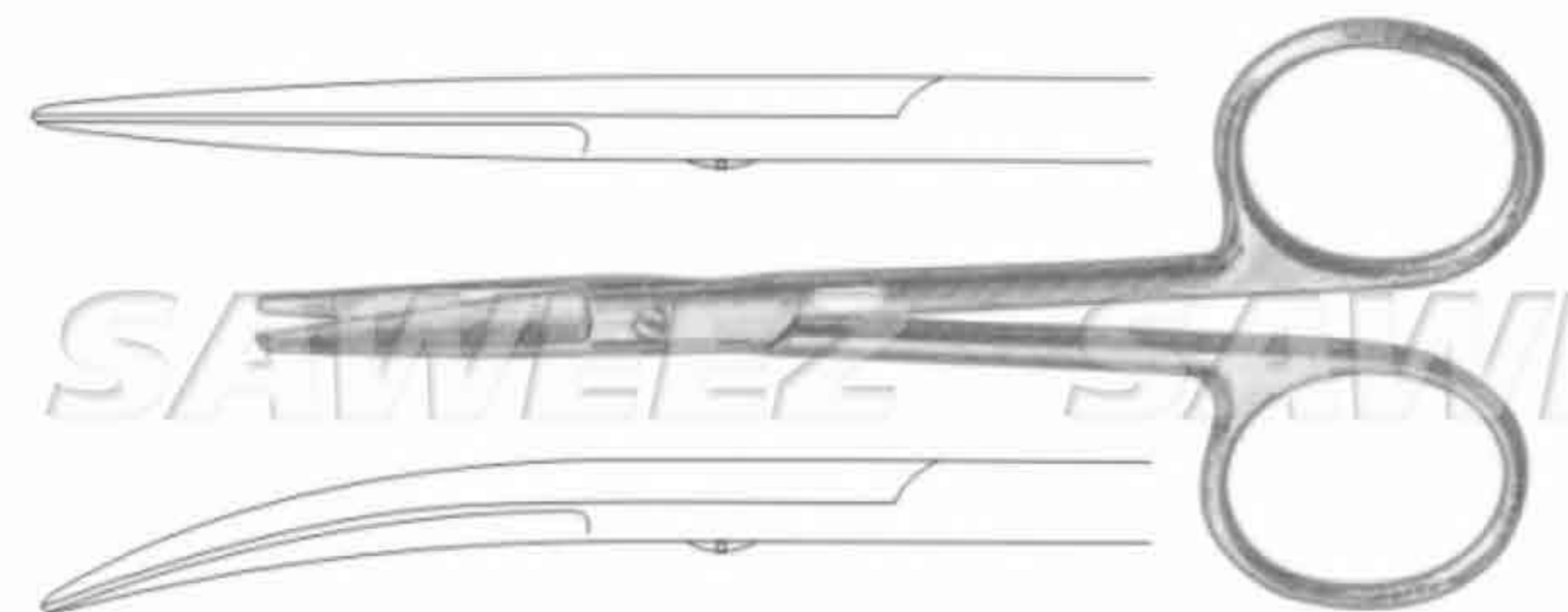
Knapp Iris Scissors

10.1 cm / 4", 25mm blades

SSC-55-12-58 Straight, blunt-blunt

SSC-55-12-59 Curved, blunt-blunt

SAWEEZ SAWEEZ



SAWEEZ SAWEEZ

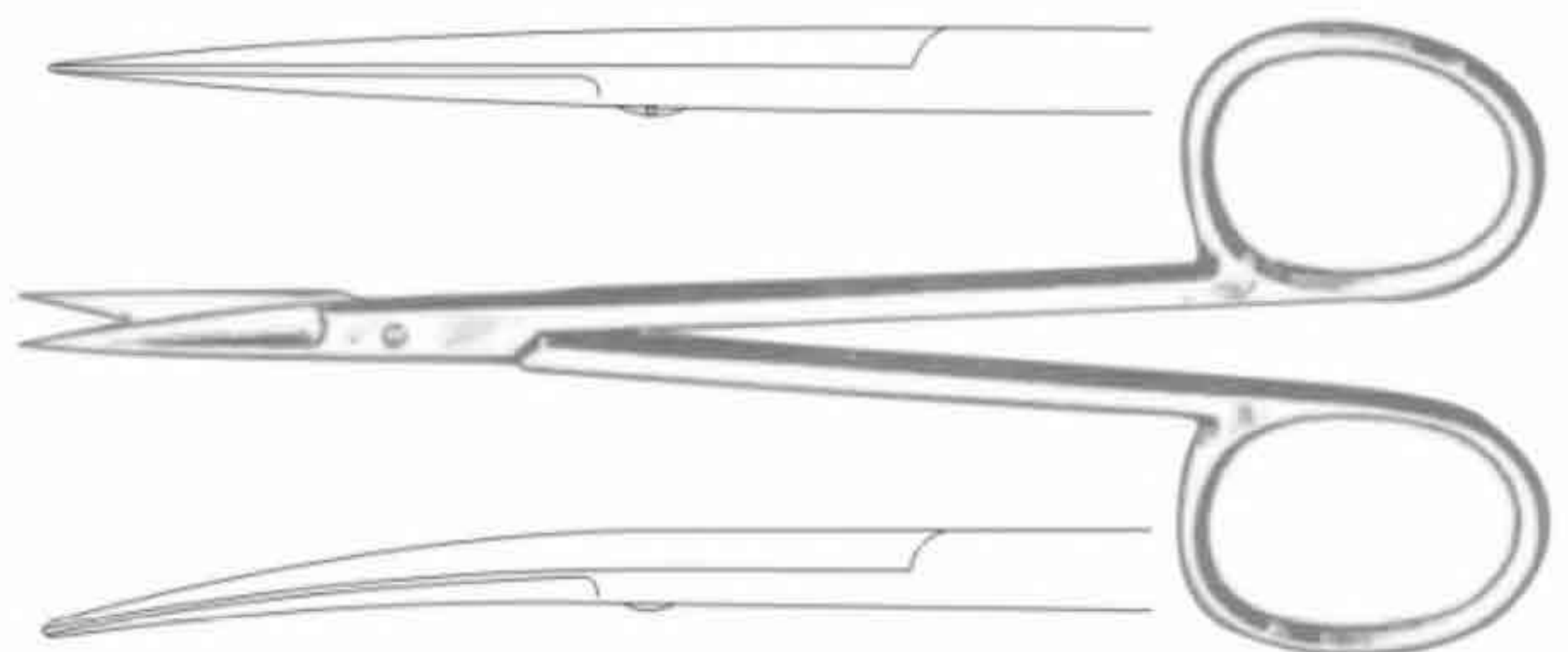
Iris Scissors

11.4 cm / 4½", 25mm blades

SSC-55-12-60 Straight, sharp-blunt

SSC-55-12-61 Curved, blunt-blunt

SAWEEZ SAWEEZ



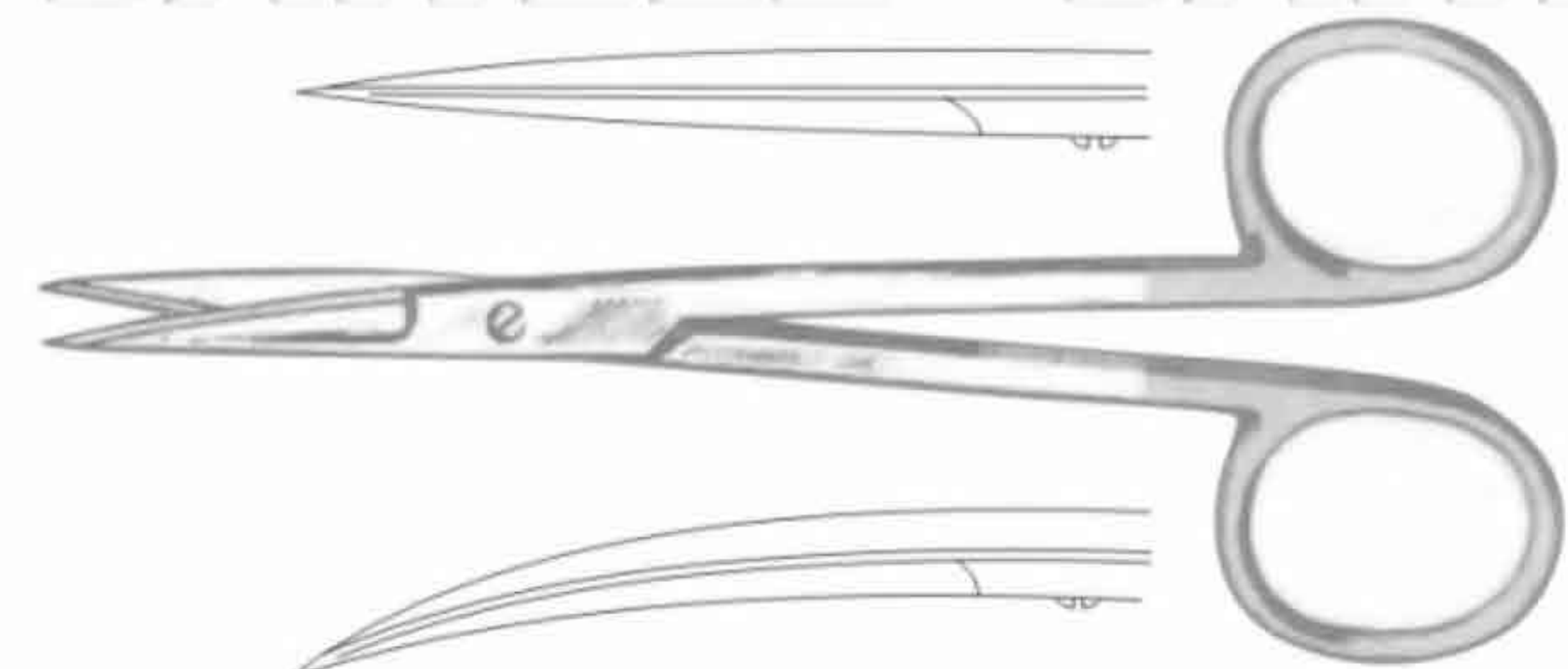
SAWEEZ SAWEEZ

Iris Scissors

11.4 cm / 4½", carb-edge, 25mm blades

SSC-55-12-62 Straight

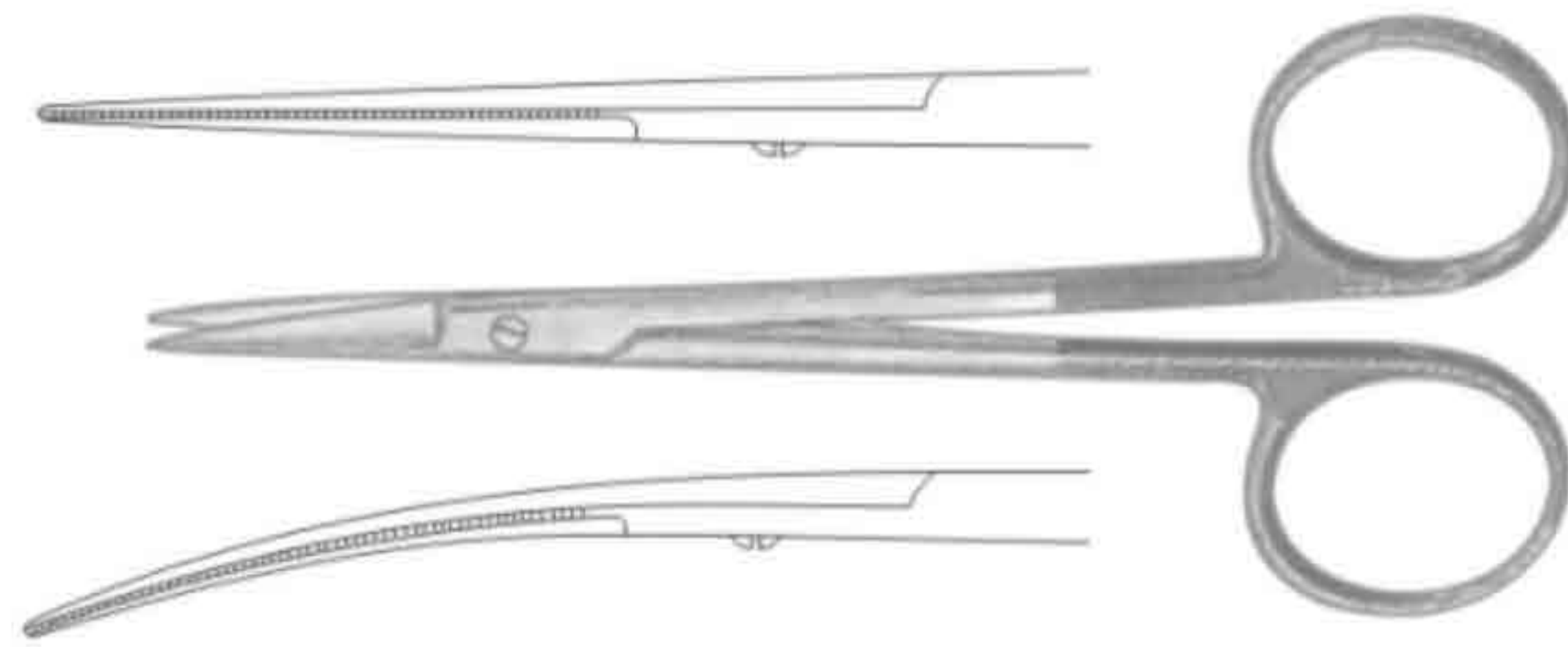
SSC-55-12-63 Curved





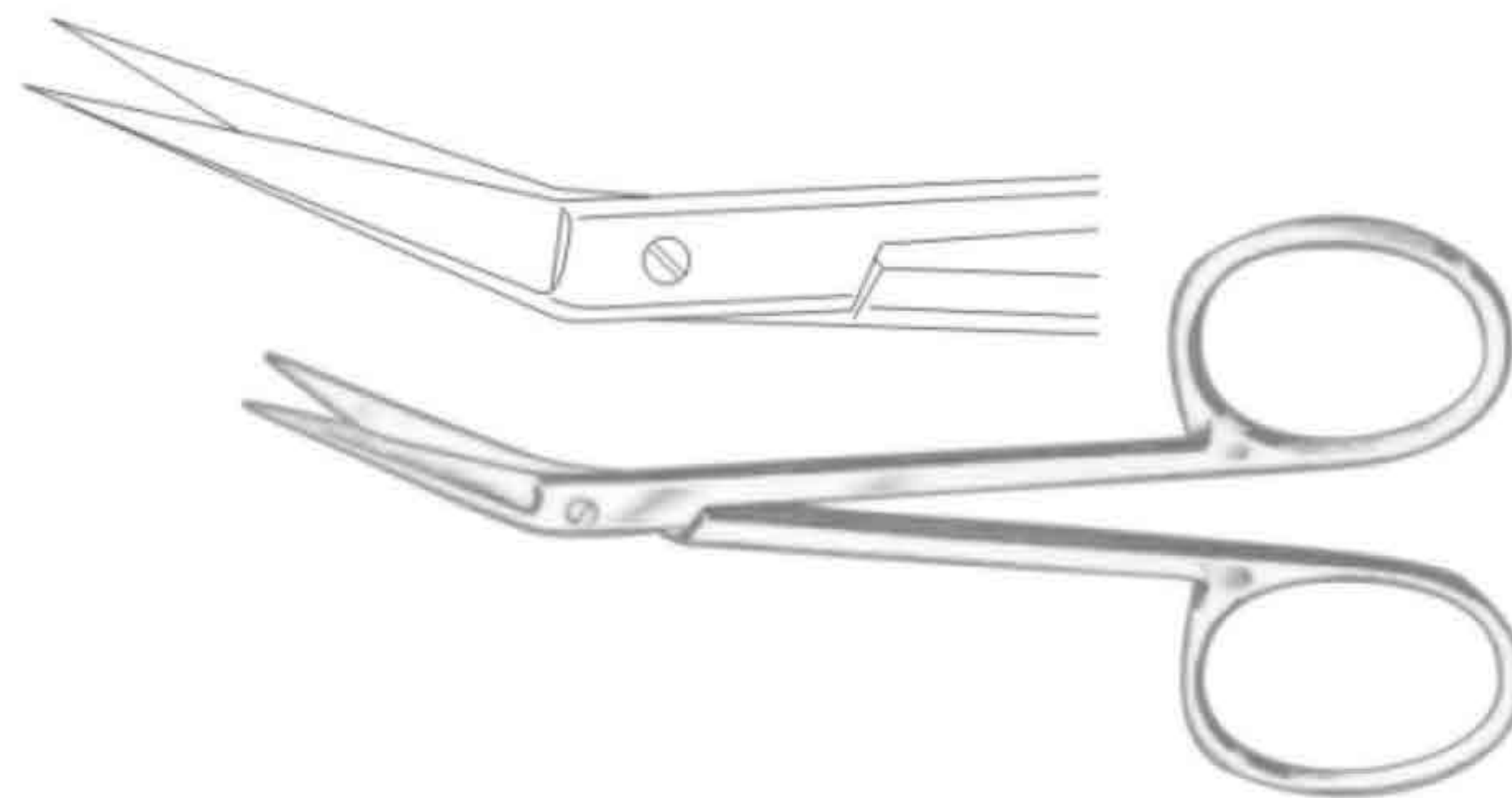
Supercut Iris Scissors
11.4 cm / 4½", 25mm blades

SSC-55-12-64 Straight
SSC-55-12-65 Curved



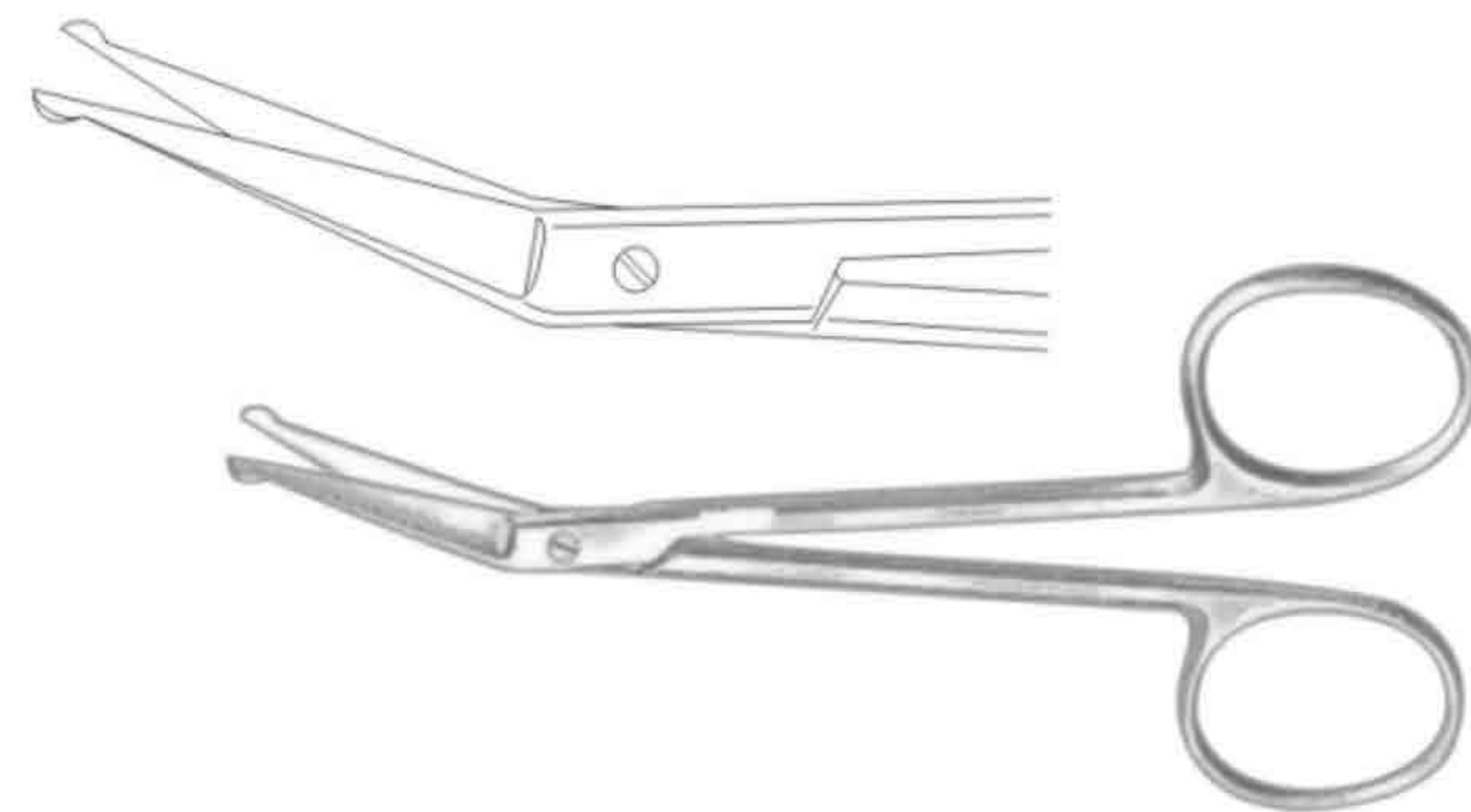
SAWEEZ SAWEEZ SAWEEZ SAWEEZ

Iris Scissors
11.4 cm / 4½", angled over edge,
25mm blades
SSC-55-12-66



SAWEEZ SAWEEZ SAWEEZ SAWEEZ

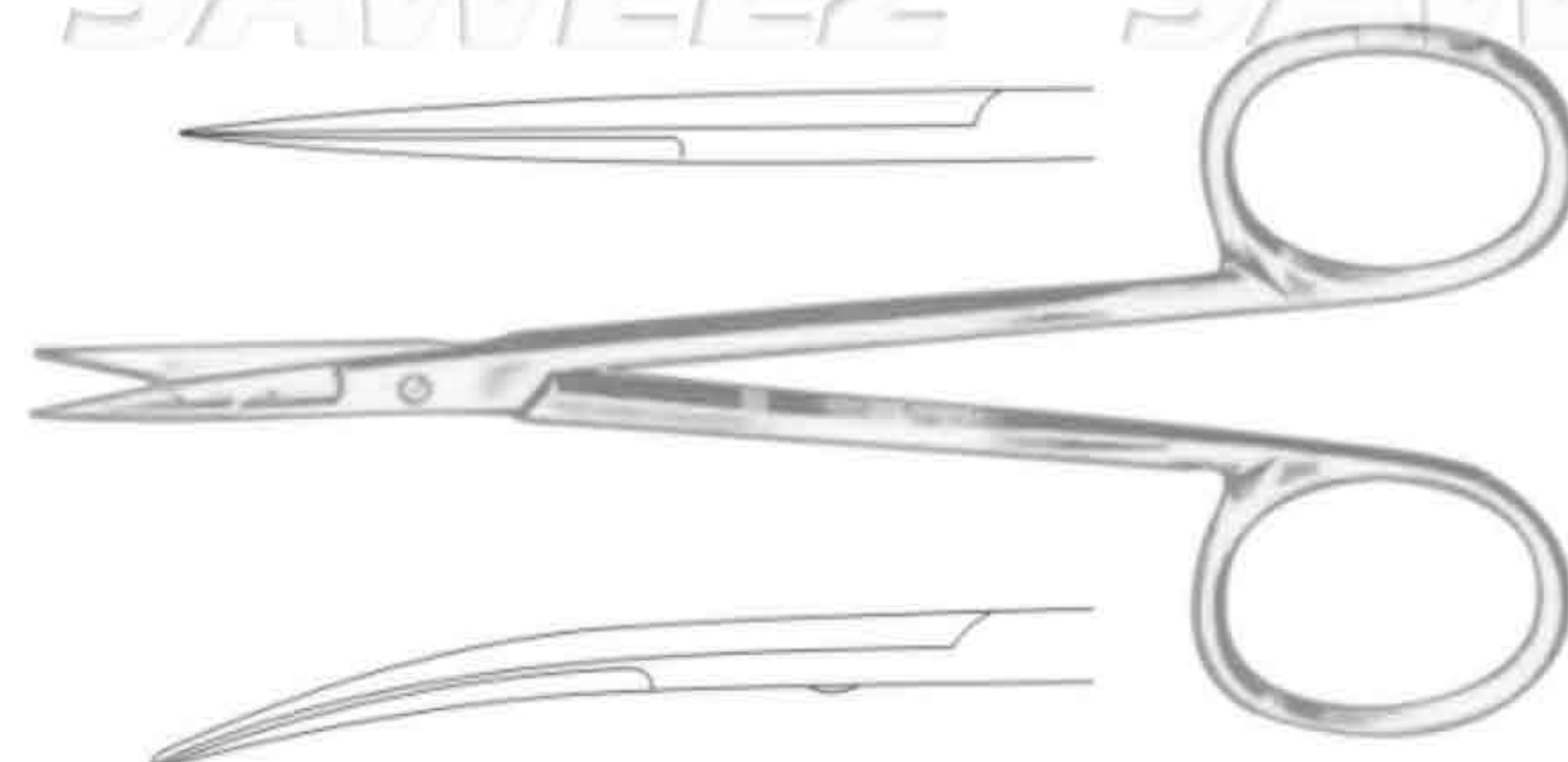
Iris Scissors
11.4 cm / 4½", angled over edge,
25mm blades, probe points
SSC-55-12-67



SAWEEZ SAWEEZ SAWEEZ SAWEEZ

Iris Scissors
22mm blades

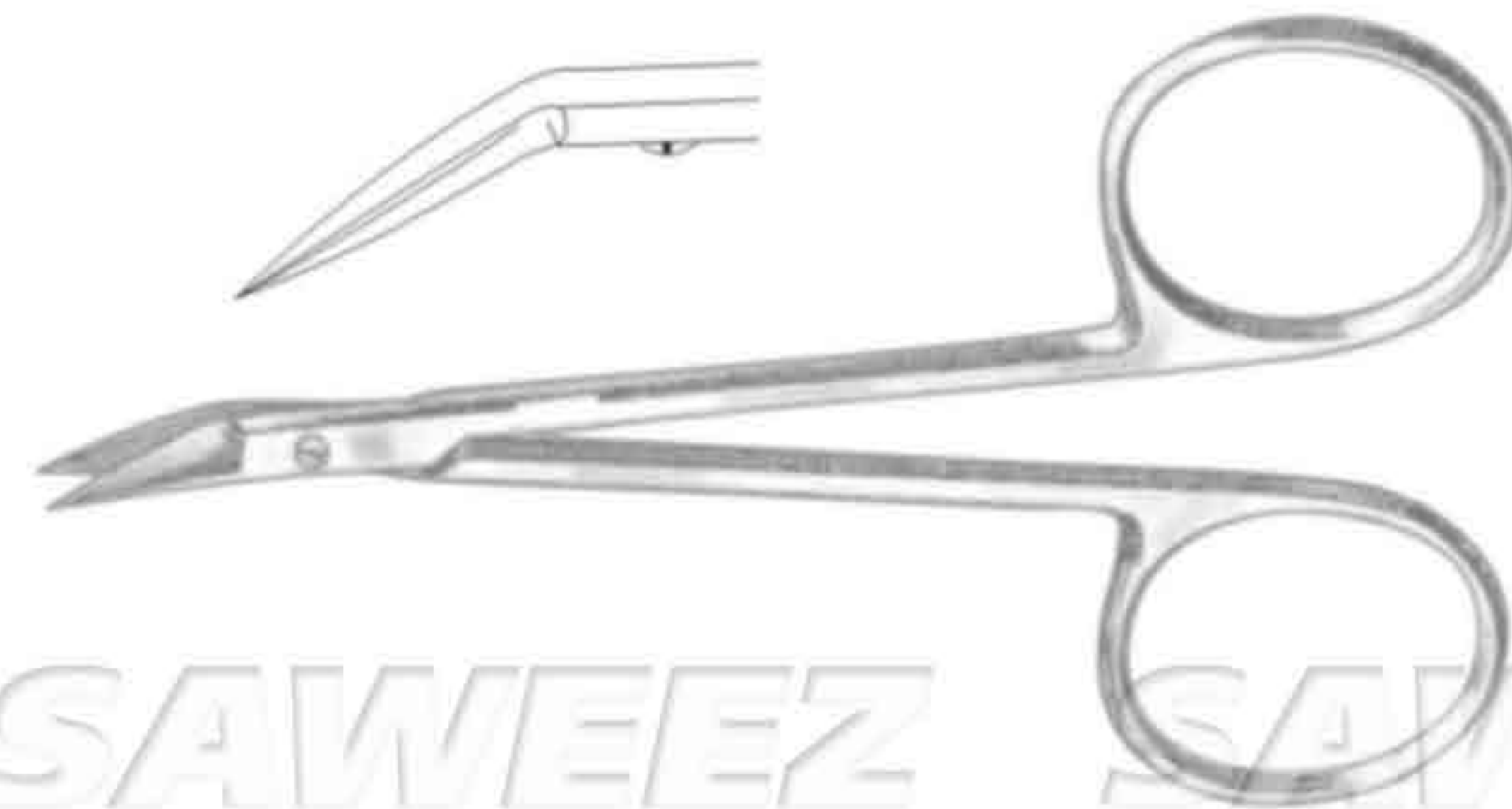
SSC-55-12-68 8.9 / 3½", straight
SSC-55-12-69 8.9 / 3½", curved
SSC-55-12-70 10.5 / 4¼", delicate, straight
SSC-55-12-71 10.5 / 4¼", delicate, curved





Wilmer Conjunctival Scissors

10.5cm, 4¹/₈", delicate, 15mm blades angled on flat
SSC-55-12-72

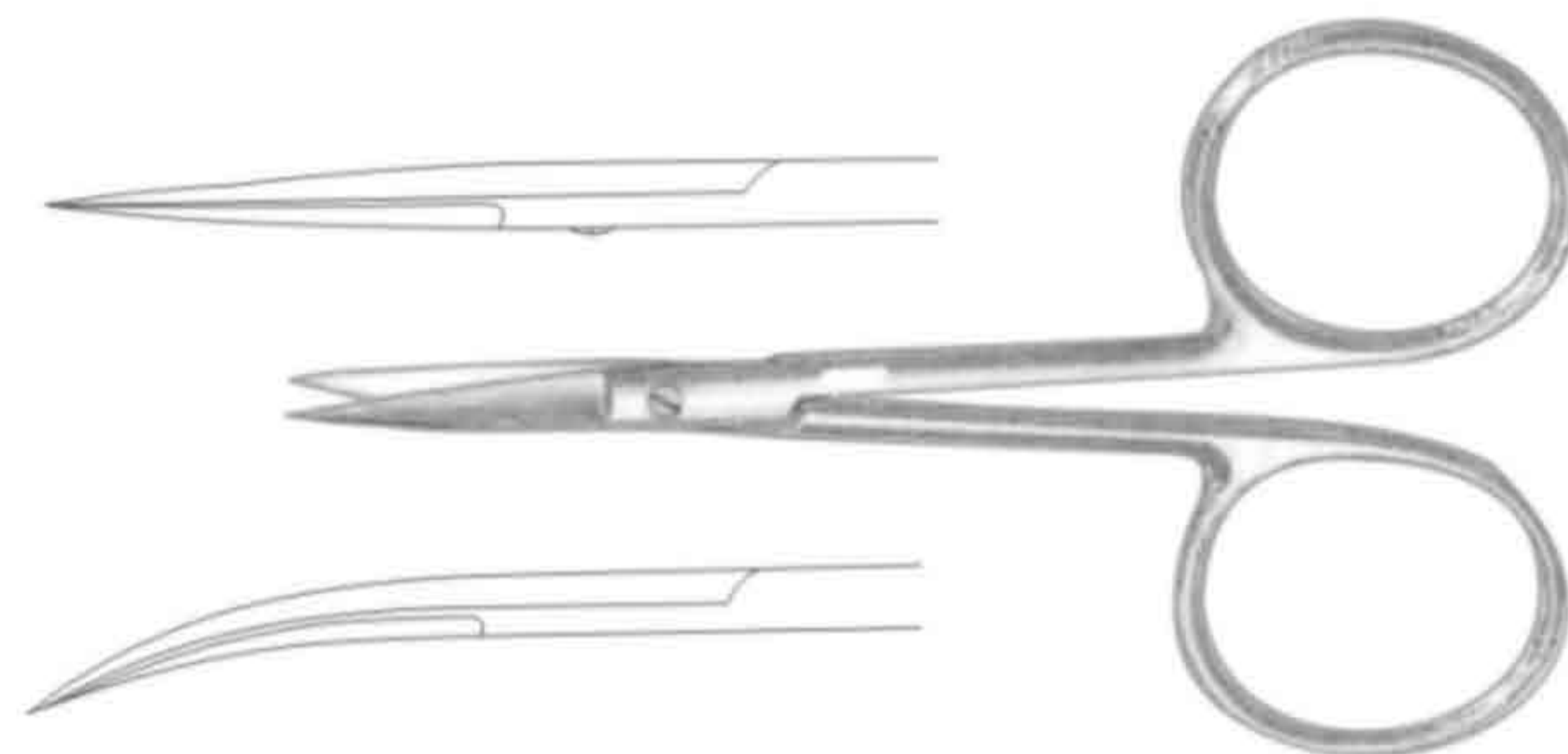


SAWEEZ SAWEEZ SAWEEZ SAWEEZ

Iris Scissors

10.2cm, 4", 24mm blades large finger rings

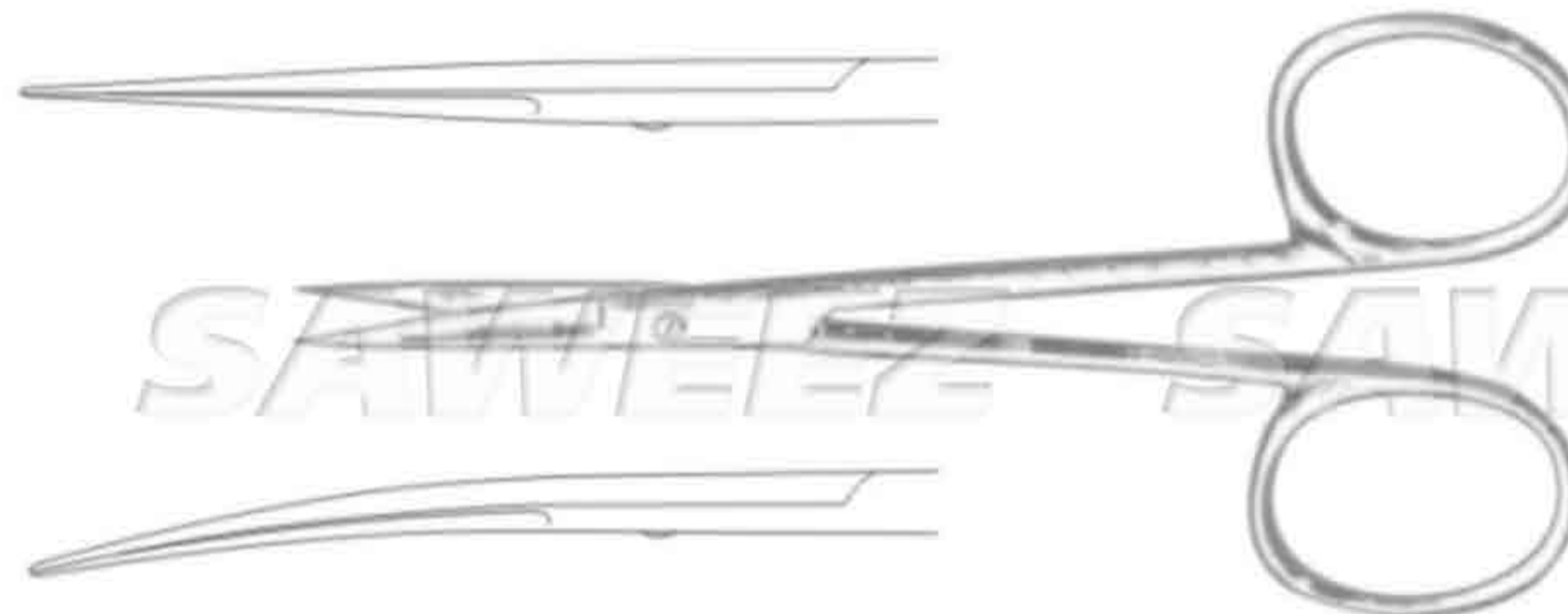
SSC-55-12-73 Straight
SSC-55-12-74 Curved



Iris Scissors

10.5cm, 4¹/₈", delicate, 27mm blades

SSC-55-12-75 Straight
SSC-55-12-76 Curved

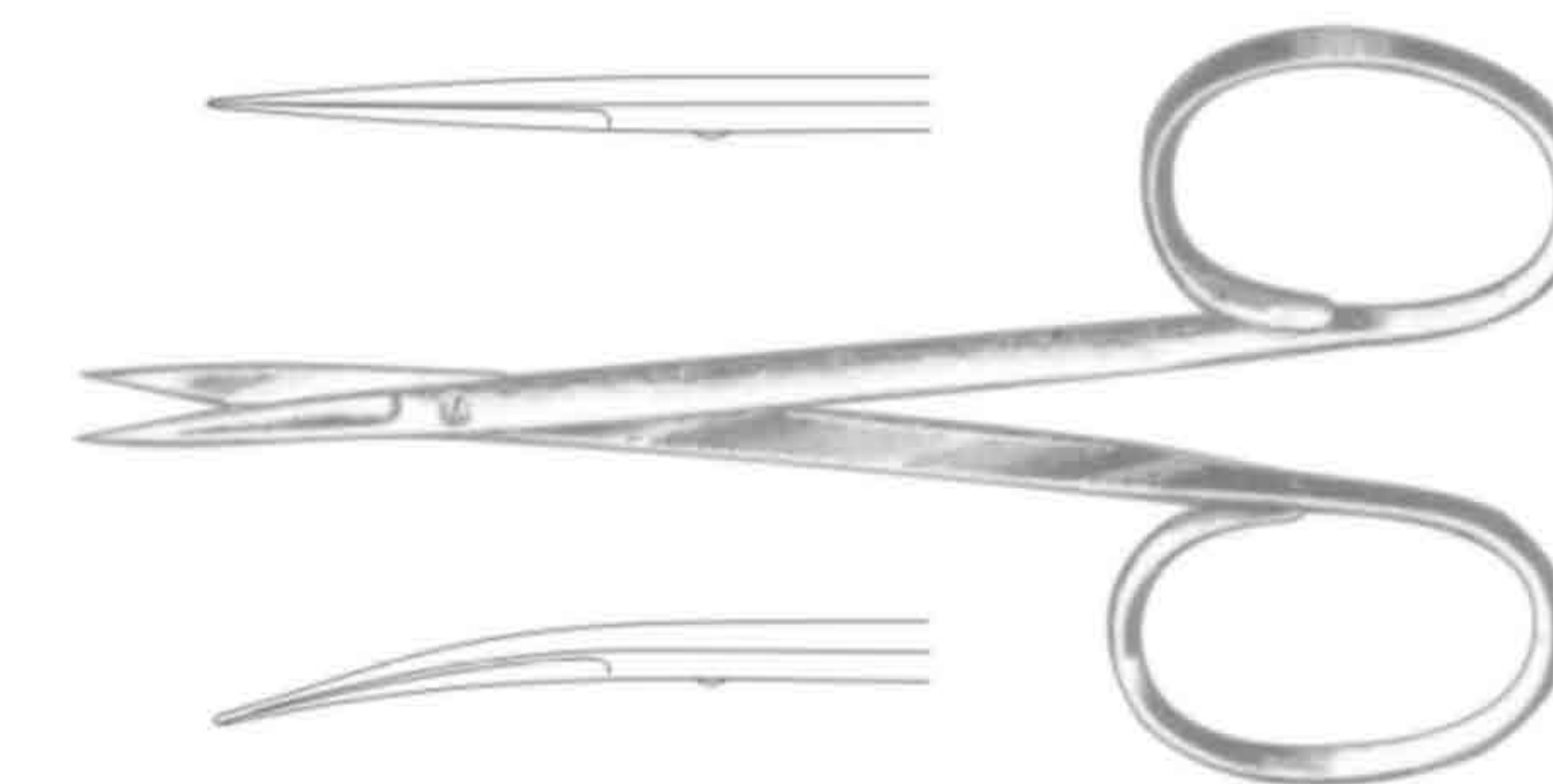


SAWEEZ SAWEEZ SAWEEZ SAWEEZ

Iris Scissors

10.2cm, 4", 22mm blades, flat shanks

SSC-55-12-77 Straight
SSC-55-12-78 Curved



SAWEEZ SAWEEZ SAWEEZ SAWEEZ

Iris Scissors

8.9cm, 3¹/₂", delicate, 12mm blades, flat shanks

SSC-55-12-79 Straight
SSC-55-12-80 Curved

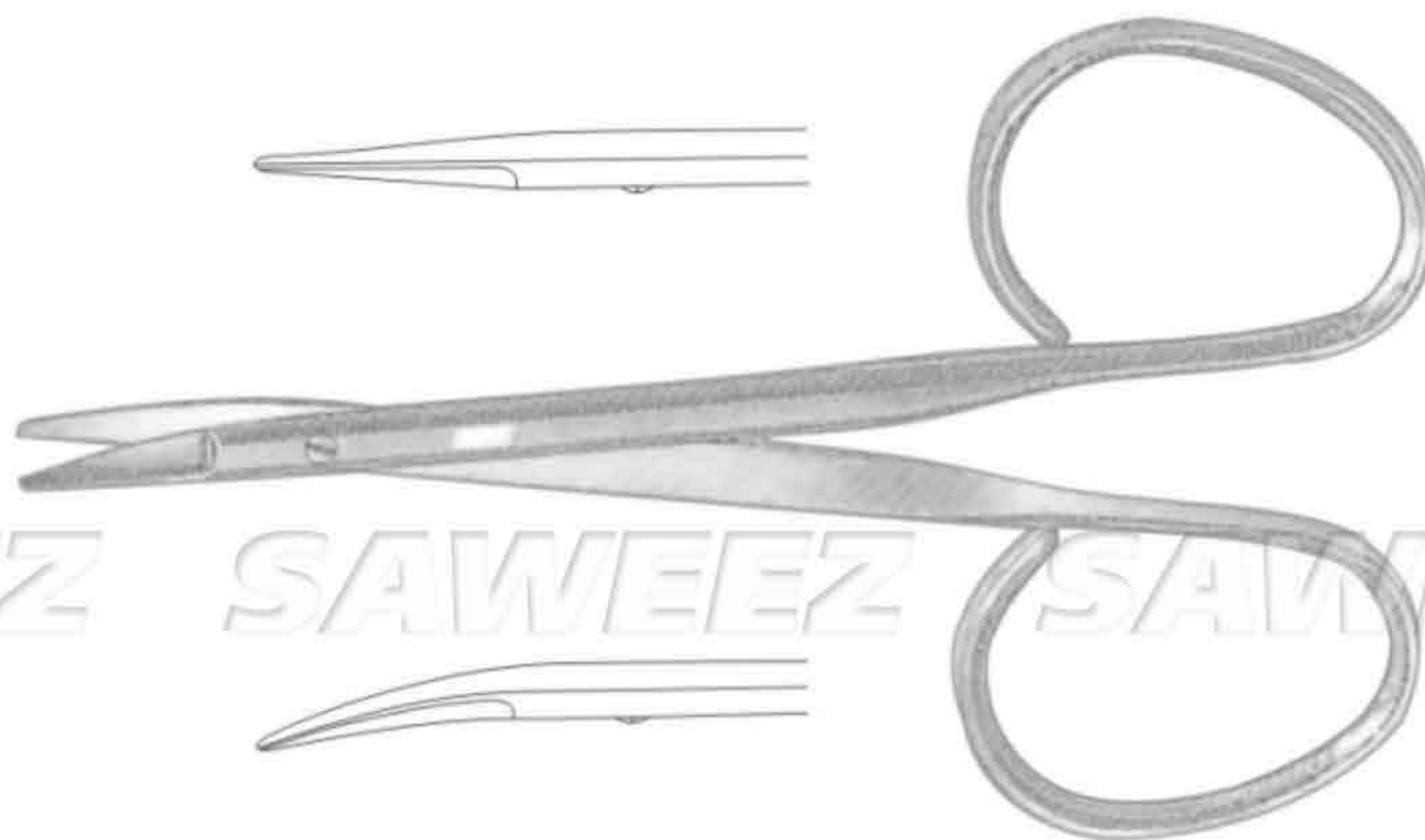




Utility Scissors

10.5cm, 4 1/8", 15mm blades, flat shanks

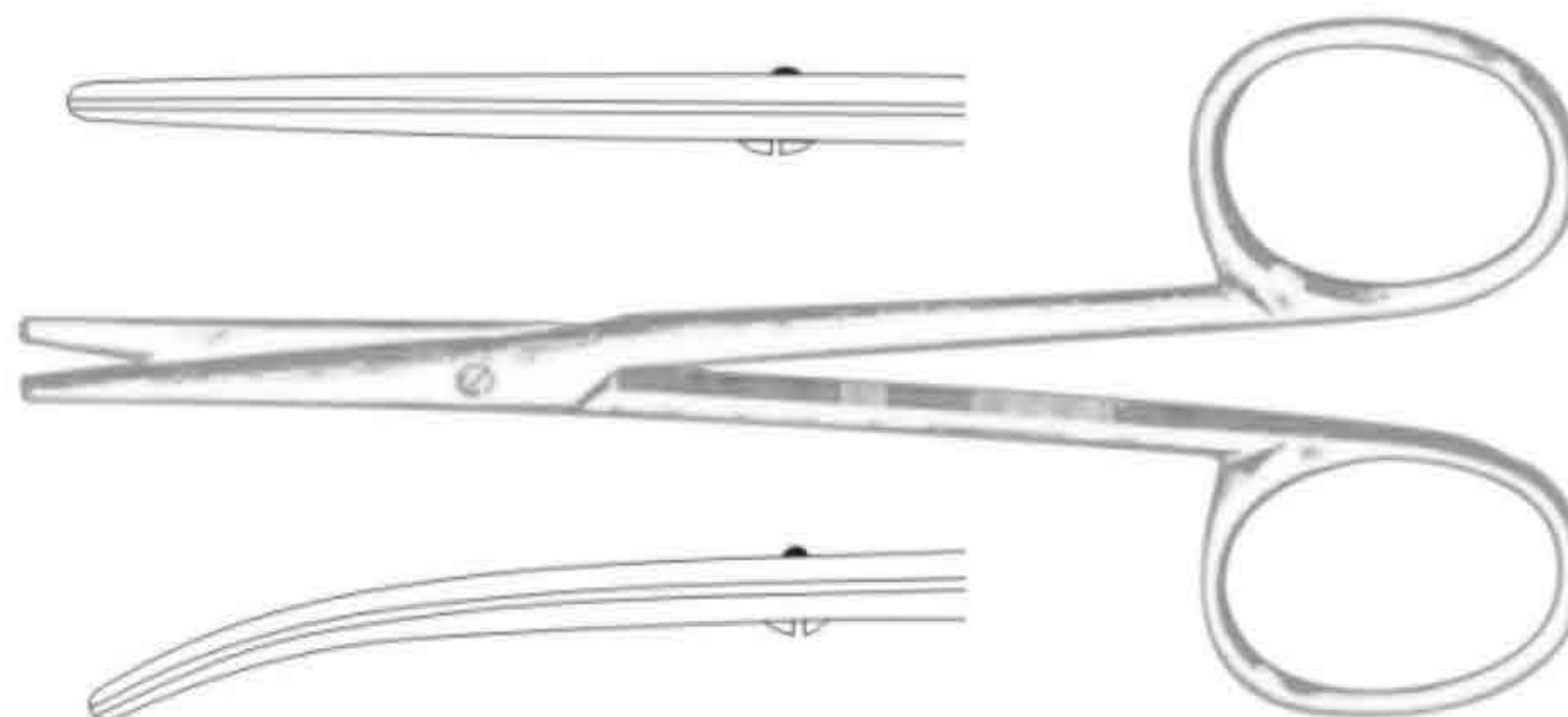
- SSC-55-12-81 Straight
- SSC-55-12-82 Curved



Strabismus Scissors

11.4cm, 4 1/2", 30mm blades

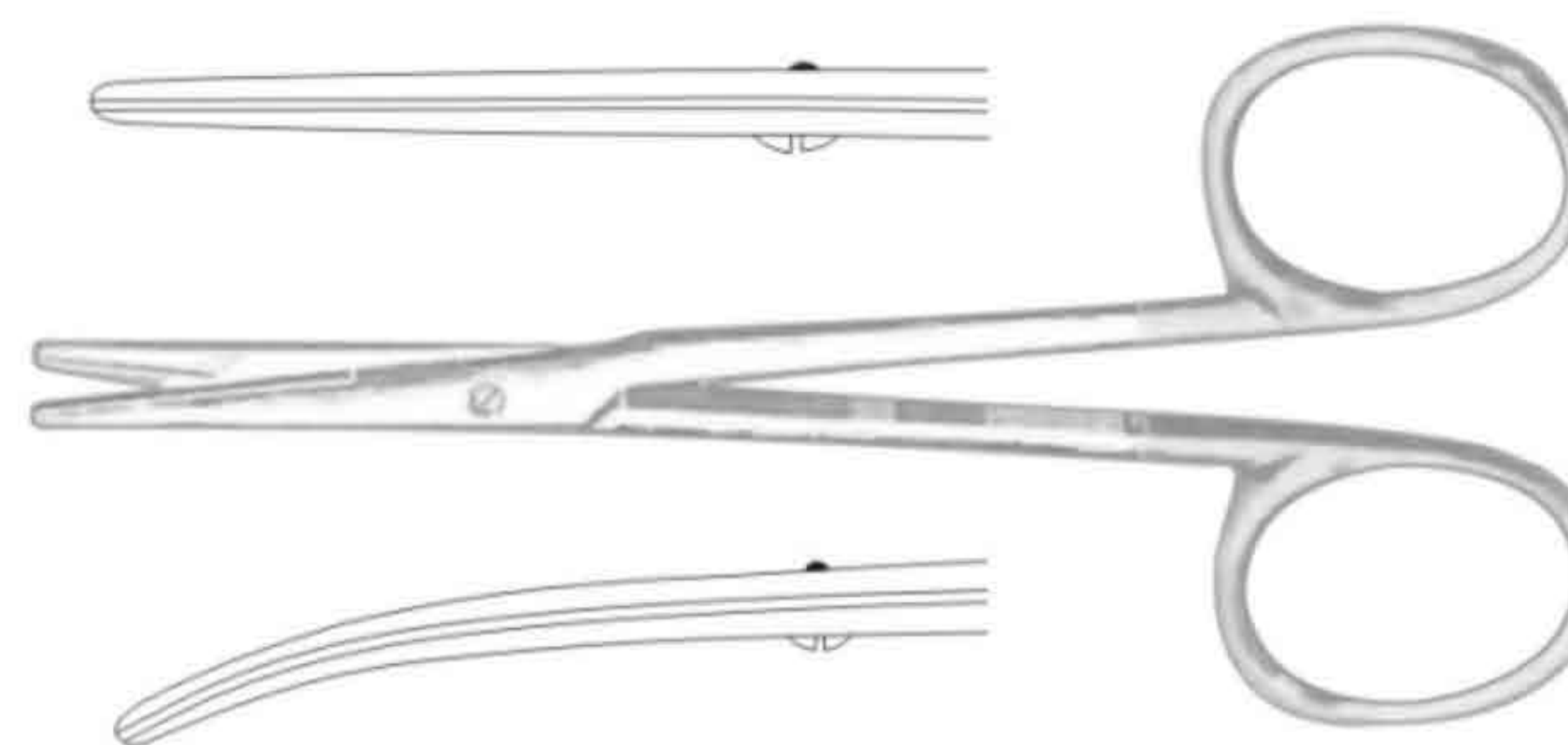
- SSC-55-12-83 Straight
- SSC-55-12-84 Curved



Strabismus Scissors

11.4cm, 4 1/2", 30mm blades Carb-edge

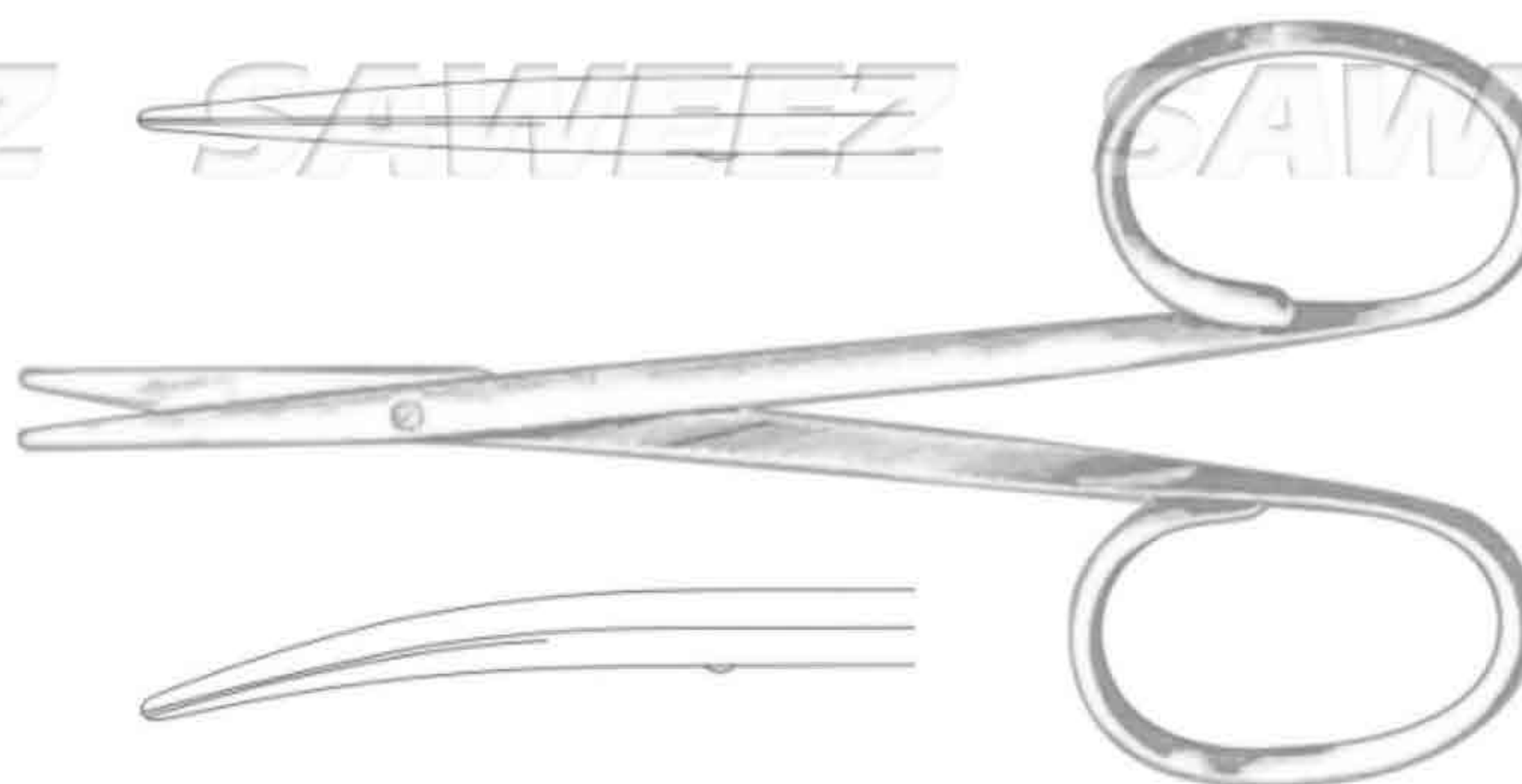
- SSC-55-12-85 Straight
- SSC-55-12-86 Curved



Strabismus Scissors

10.5cm, 4 1/8", 25mm blades flat shanks

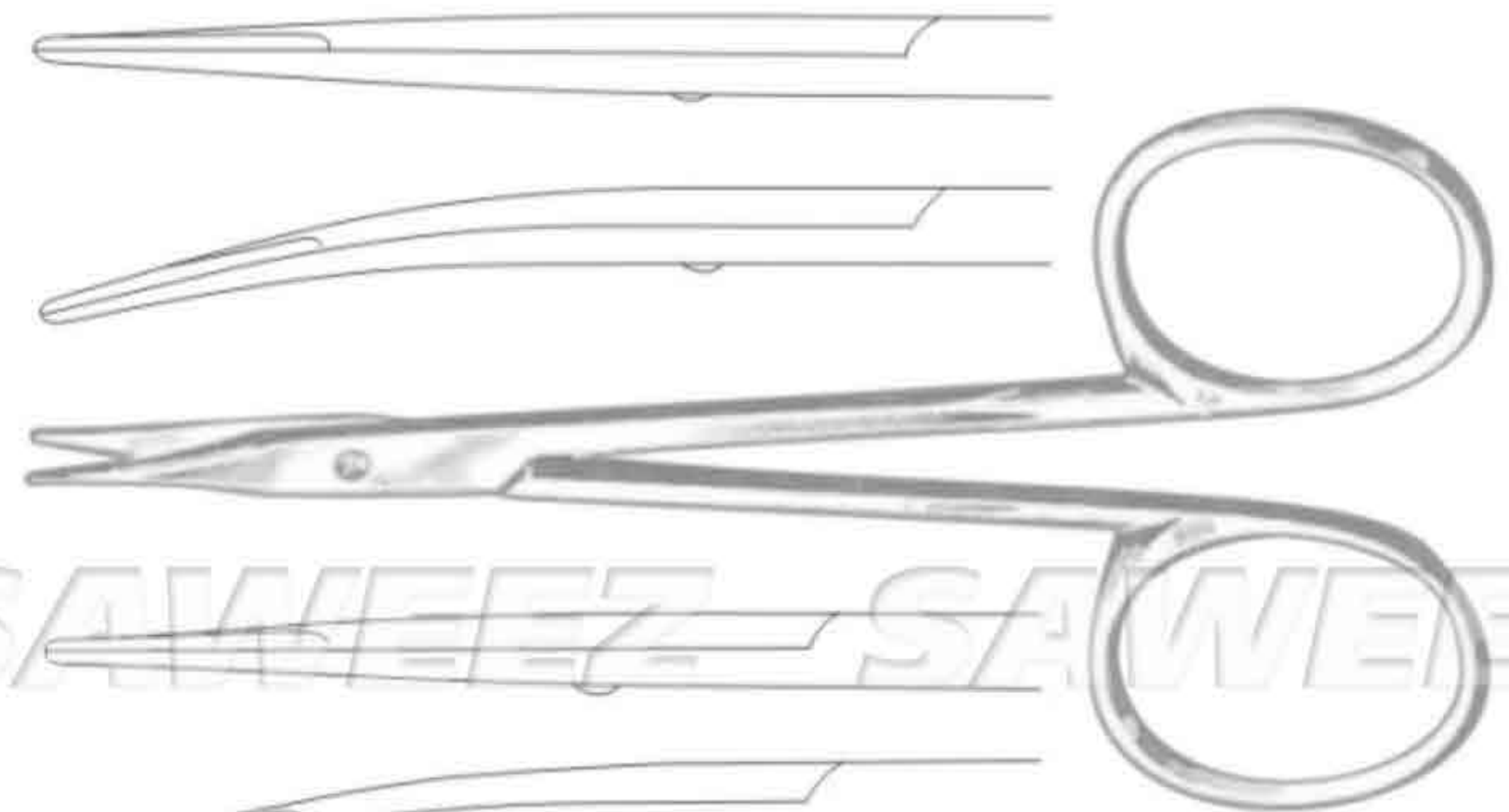
- SSC-55-12-87 Straight
- SSC-55-12-88 Curved





Stevens Tenotomy Scissors, blunt tips

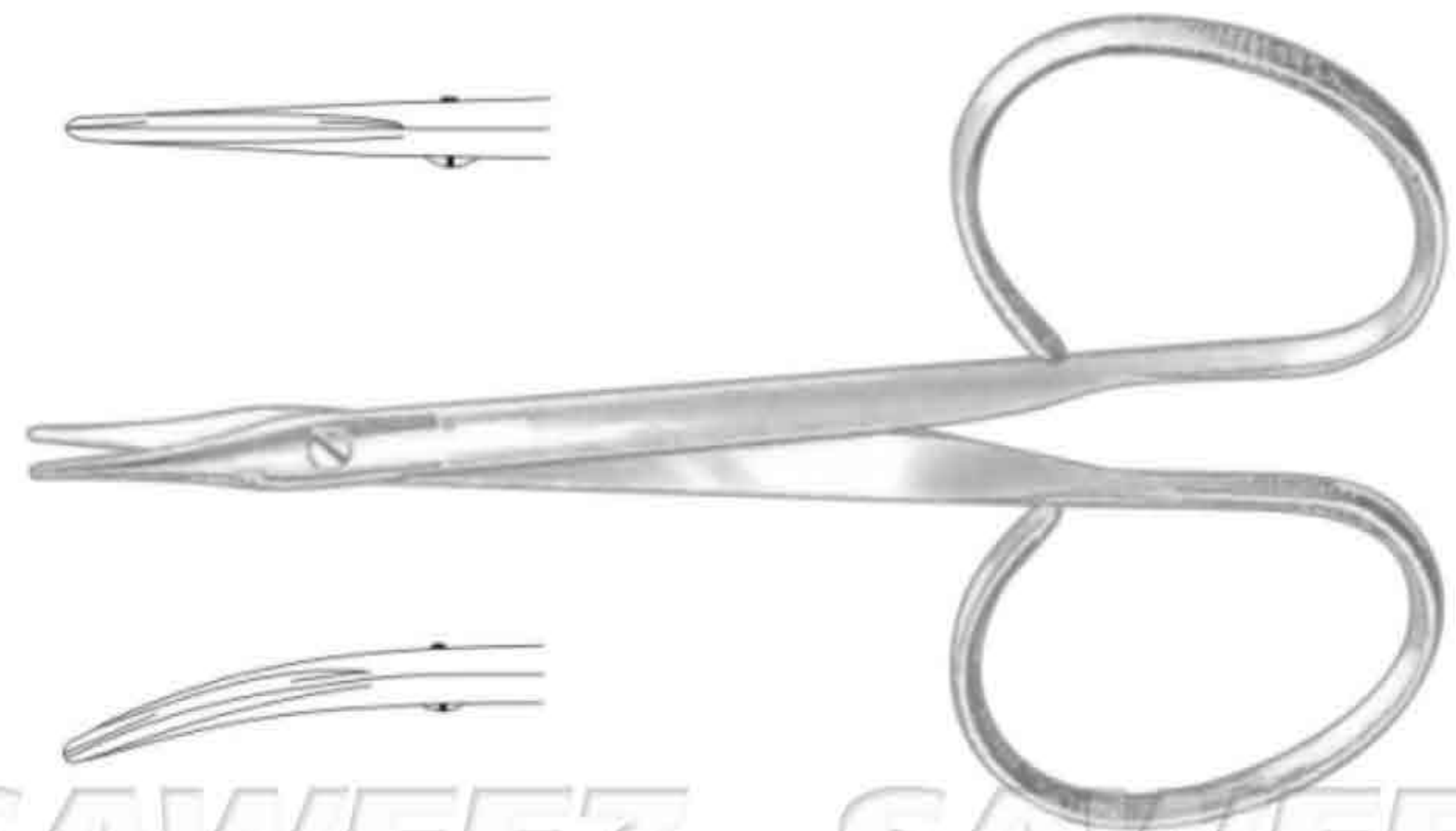
- SSC-55-12-89 11.4cm / 4½", straight, slender pattern, 13mm blades
- SSC-55-12-90 11.4cm / 4½", curved, slender pattern, 13mm blades
- SSC-55-12-91 10.5cm / 4¼", straight, standard pattern, 12mm blades
- SSC-55-12-92 10.5cm / 4¼", curved, standard pattern, 12mm blades



Stevens Tenotomy Scissors

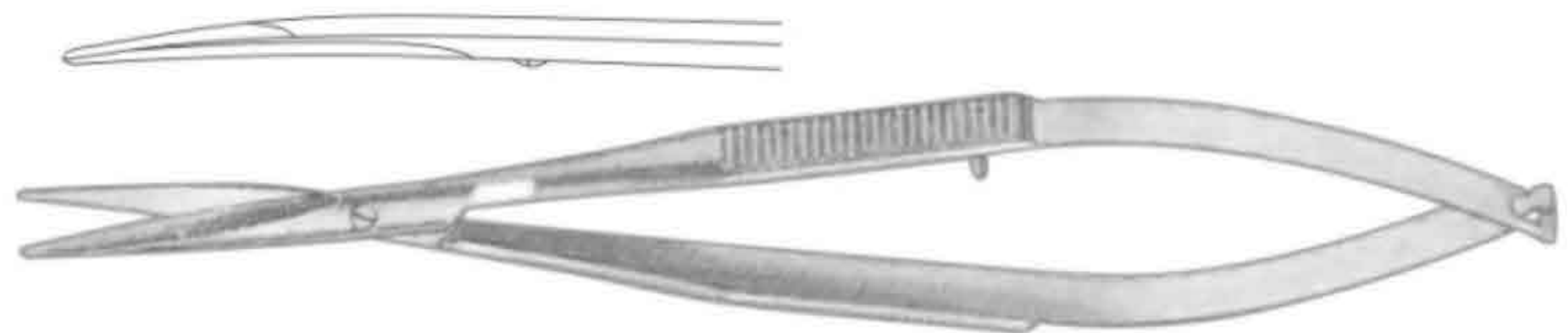
9.5cm / 3¾", 13mm blades, blunt tips, flat shanks

- CCS-55-12-93 Straight
- CCS-55-12-94 Curved



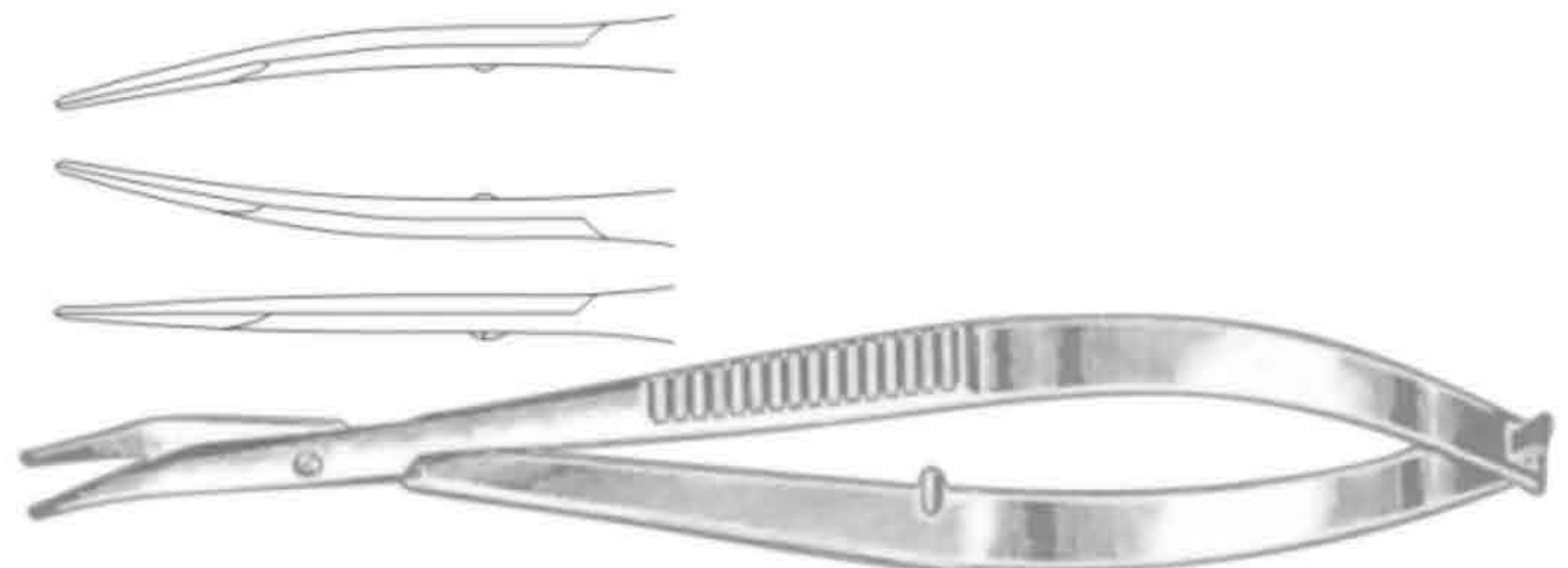
Westcott Utility Scissors

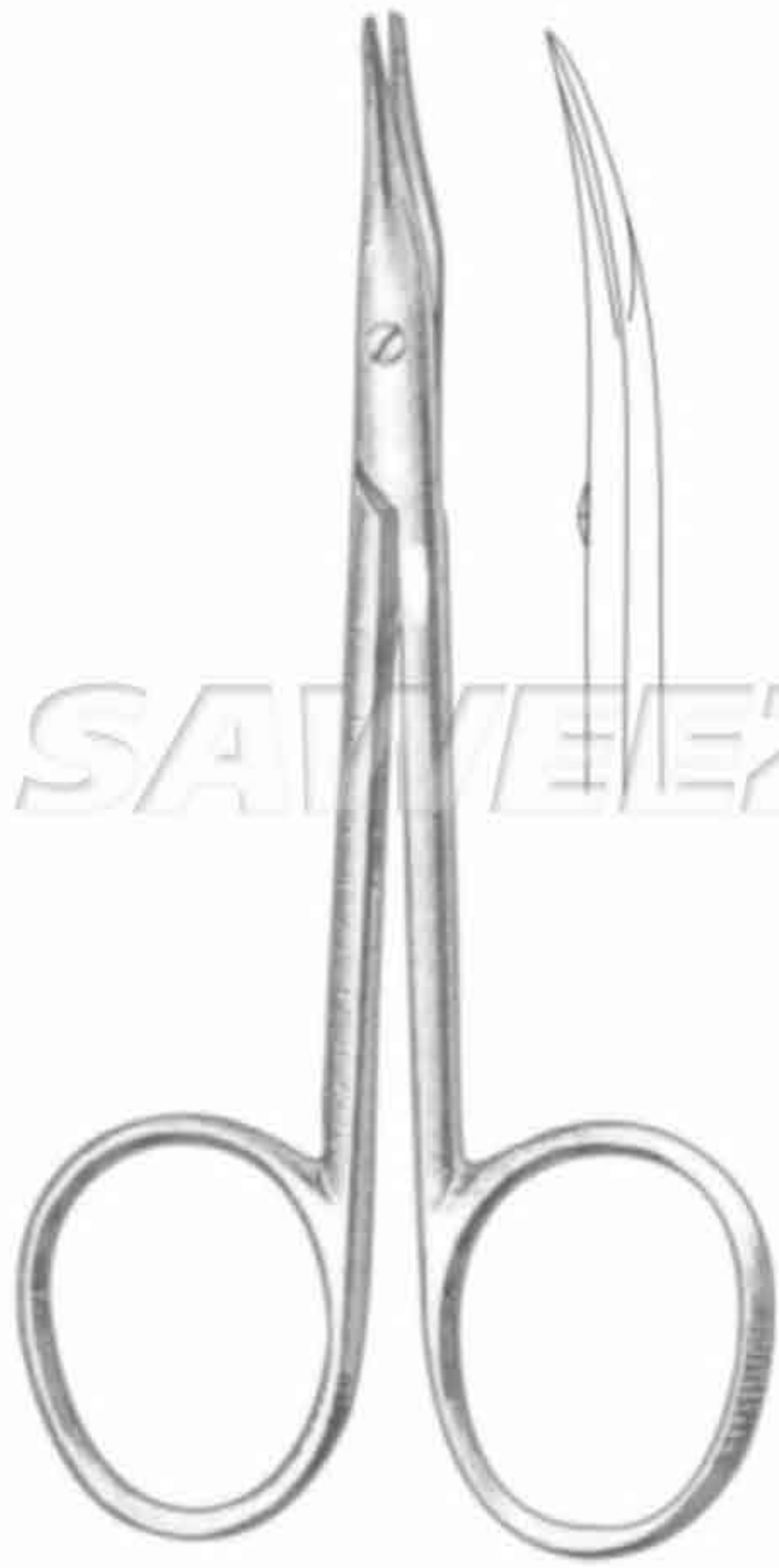
13.0cm / 5⅛", 23mm blades, curved round sharp tips
CCS-55-12-95



Westcott Tenotomy Scissors

11.4cm / 4½", 18mm blades, round blunt tips
CSS-55-12-96 Right, curved
CSS-55-12-97 Left, curved
CSS-55-12-98 Straight

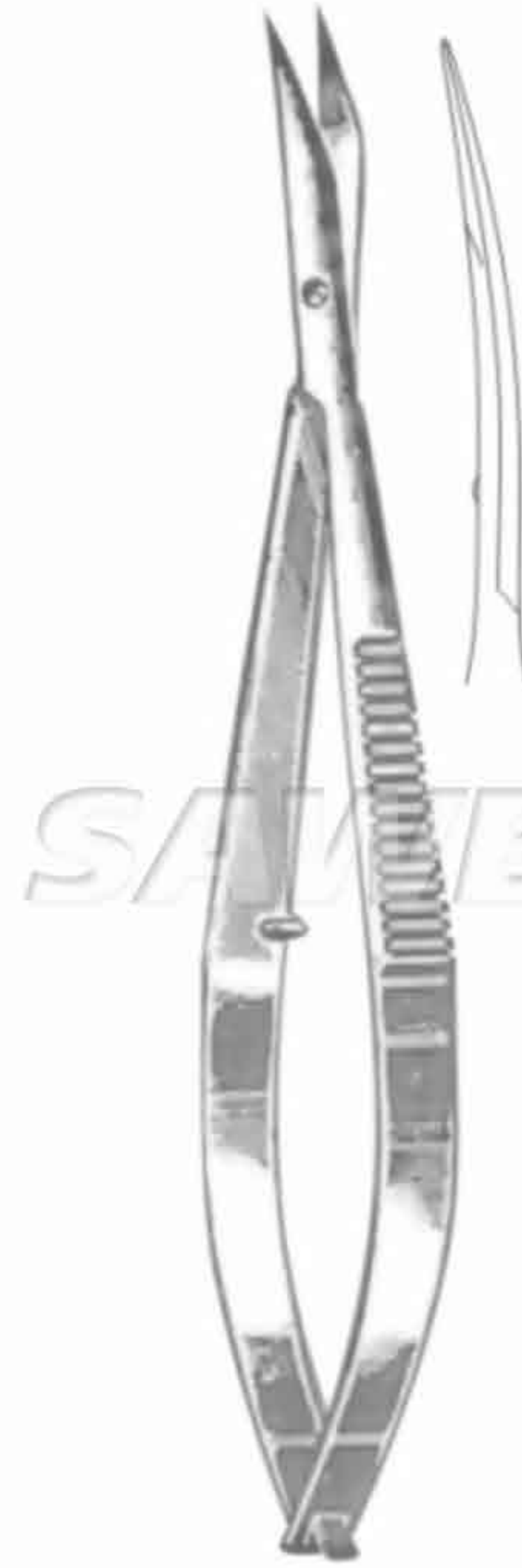




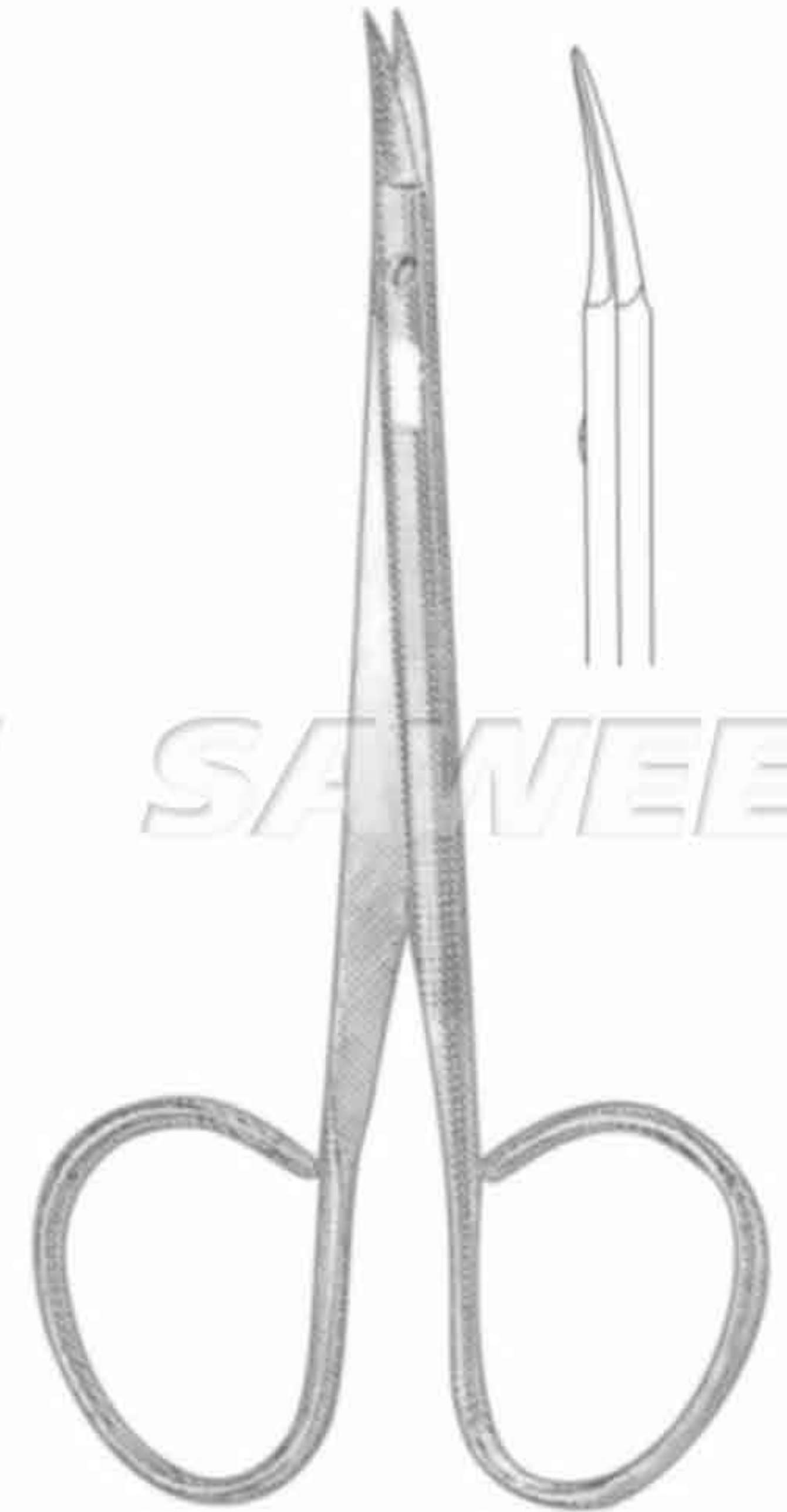
Stevens Stitch Scissors
10.5cm / 4 $\frac{1}{8}$ ", 14mm blades,
curved, sharp tips
SSC-55-12-99



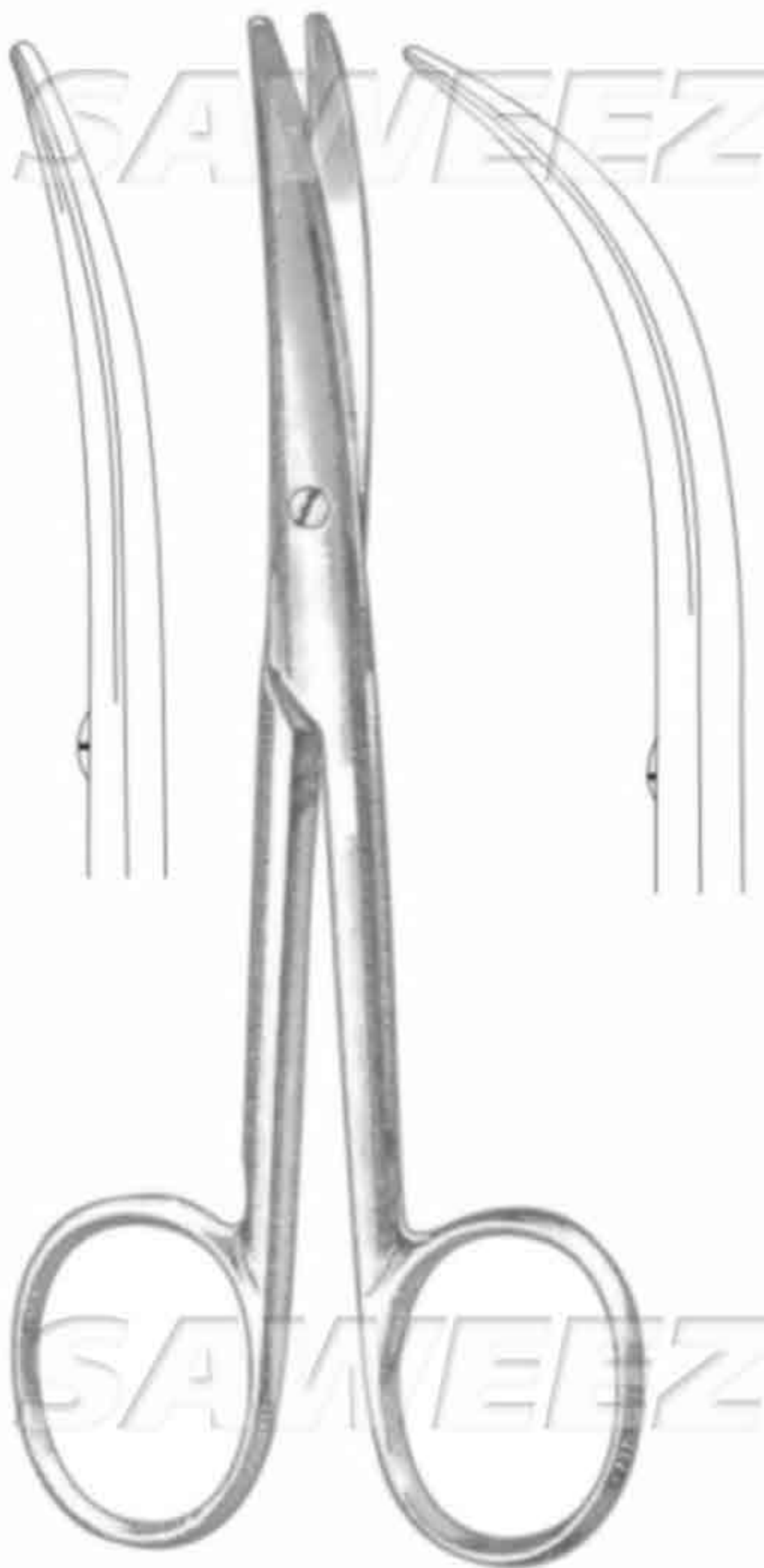
Stevens Stitch Scissors
9.5cm / 3 $\frac{3}{4}$ ", 12mm blades,
curved sharp tips, flat shanks
SSC-55-13-00



Westcott Stitch Scissors
11.5cm / 4 $\frac{1}{2}$ ", 18mm blades,
curved, fine sharp tips
SSC-55-13-01

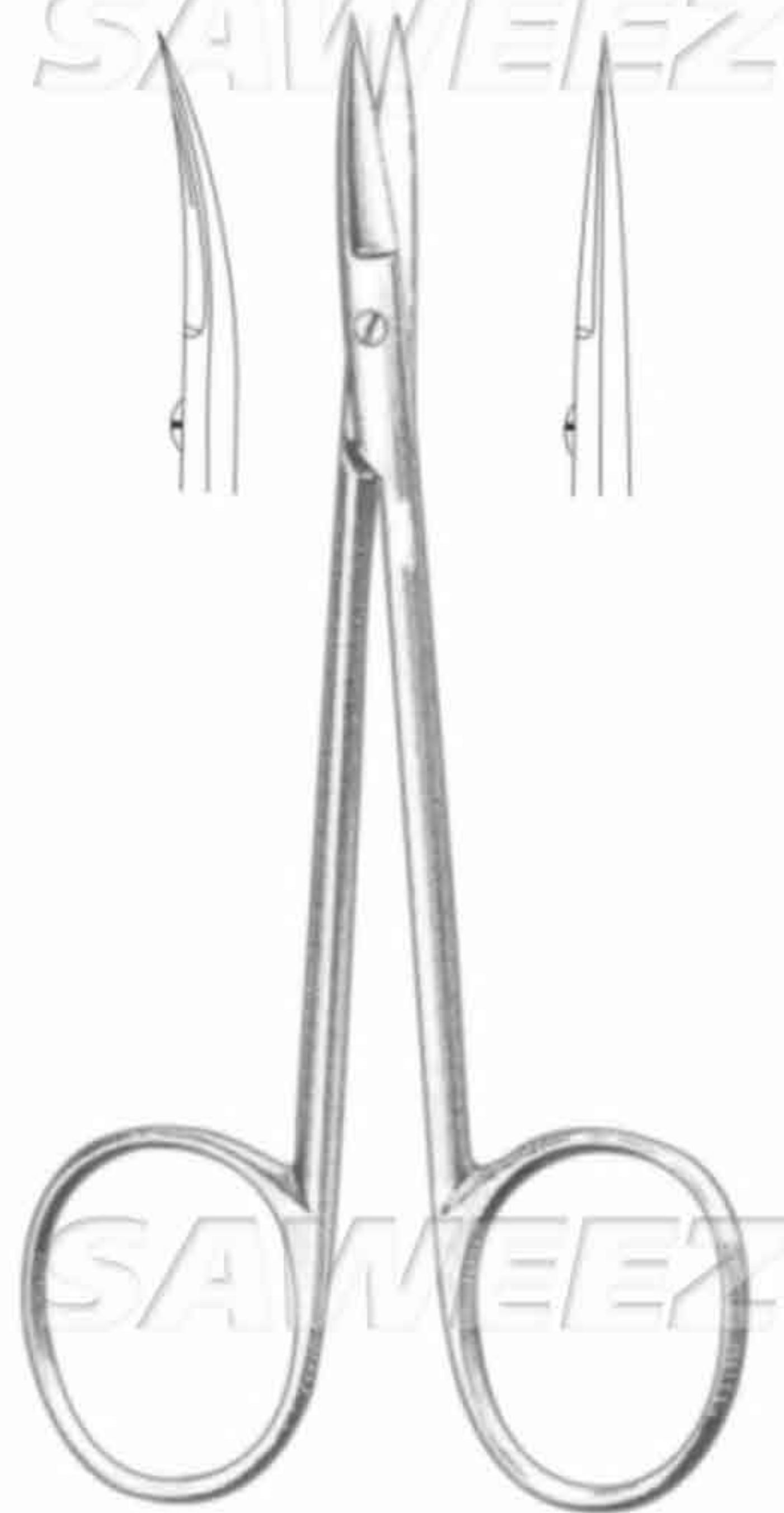


Stitch Scissors
12.4cm / 4 $\frac{7}{8}$ ", 13mm blades,
curved, fine sharp tips, flat shanks
SSC-55-13-02

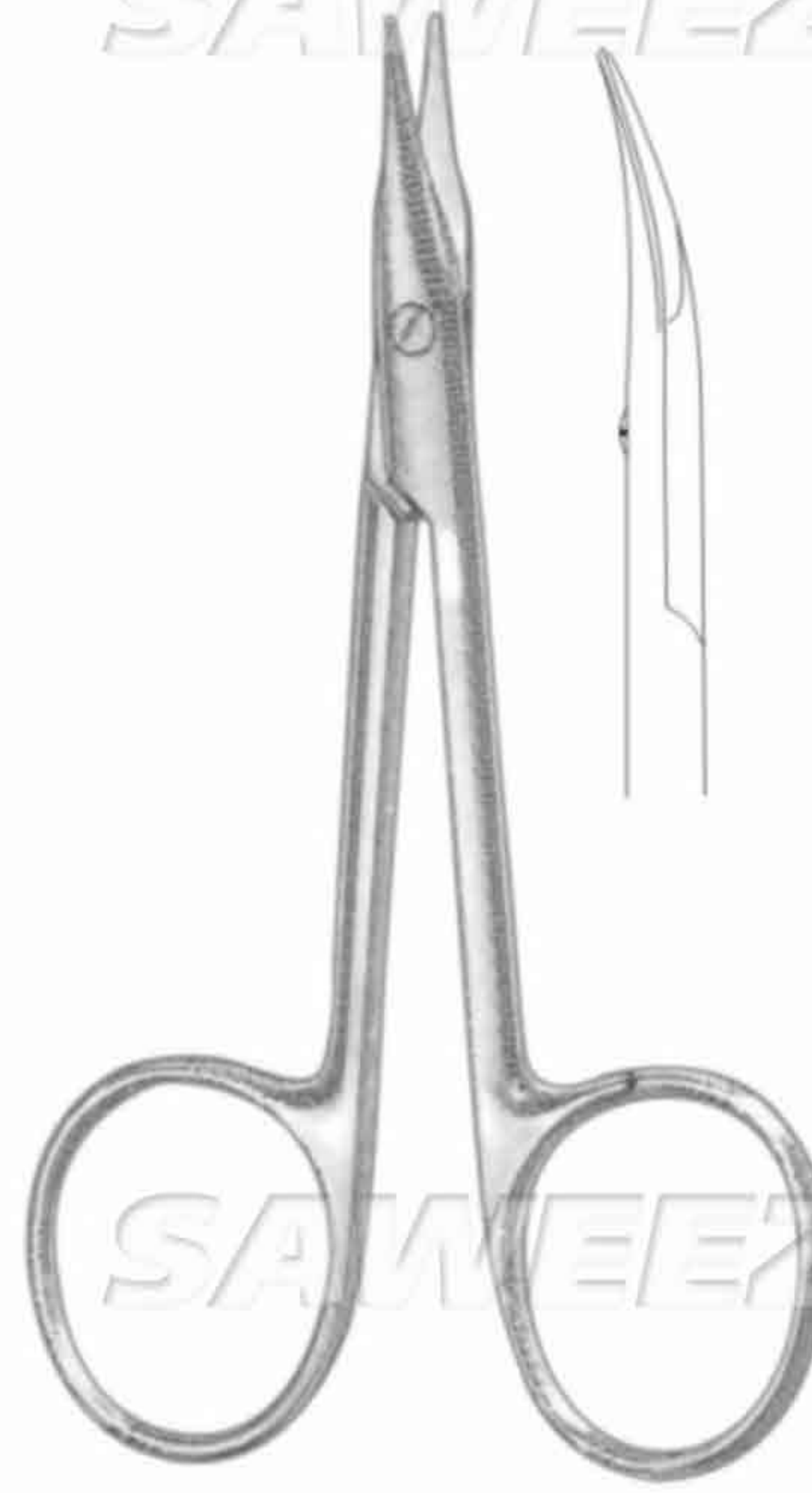


Enucleation Scissors
13.0cm / 5 $\frac{1}{8}$ ", 32mm blades,
strong curve
SSC-55-13-03

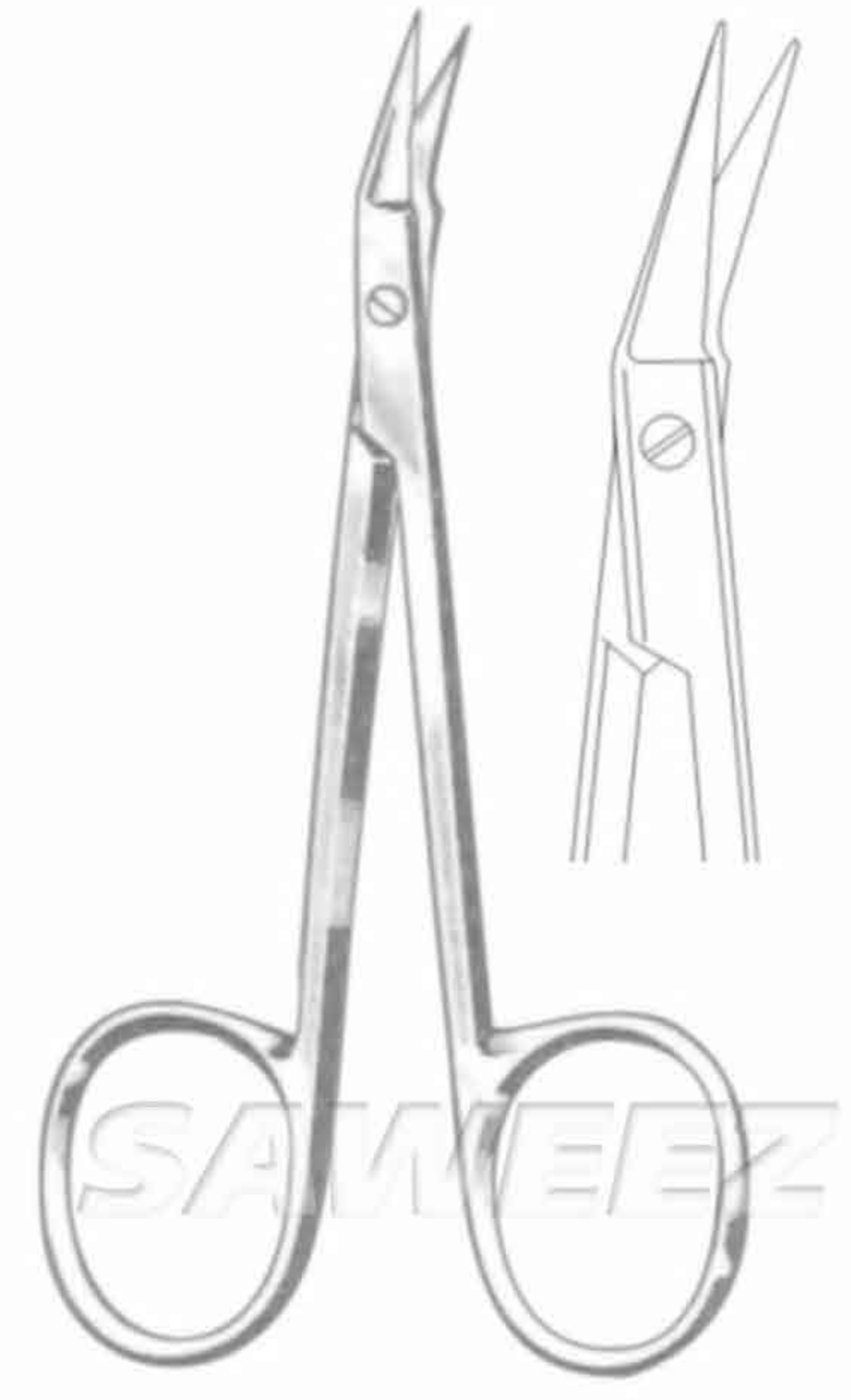
Enucleation Scissors
13.0cm / 5", 27mm blades,
light curve
SSC-55-13-04



Stitch Scissors
9.8cm / 3 $\frac{7}{8}$ ", 15mm blades,
semi-sharp tips
SSC-55-13-05 Straight
SSC-55-13-06 Curved



Gradle Stitch Scissors
9.5cm / 3 $\frac{3}{4}$ ", 13mm blades,
blunt tips
SSC-55-13-07



O'Brien Suture Scissors
9.5cm / 3 $\frac{3}{4}$ ", 15mm blades,
blunt tips
SSC-55-13-08



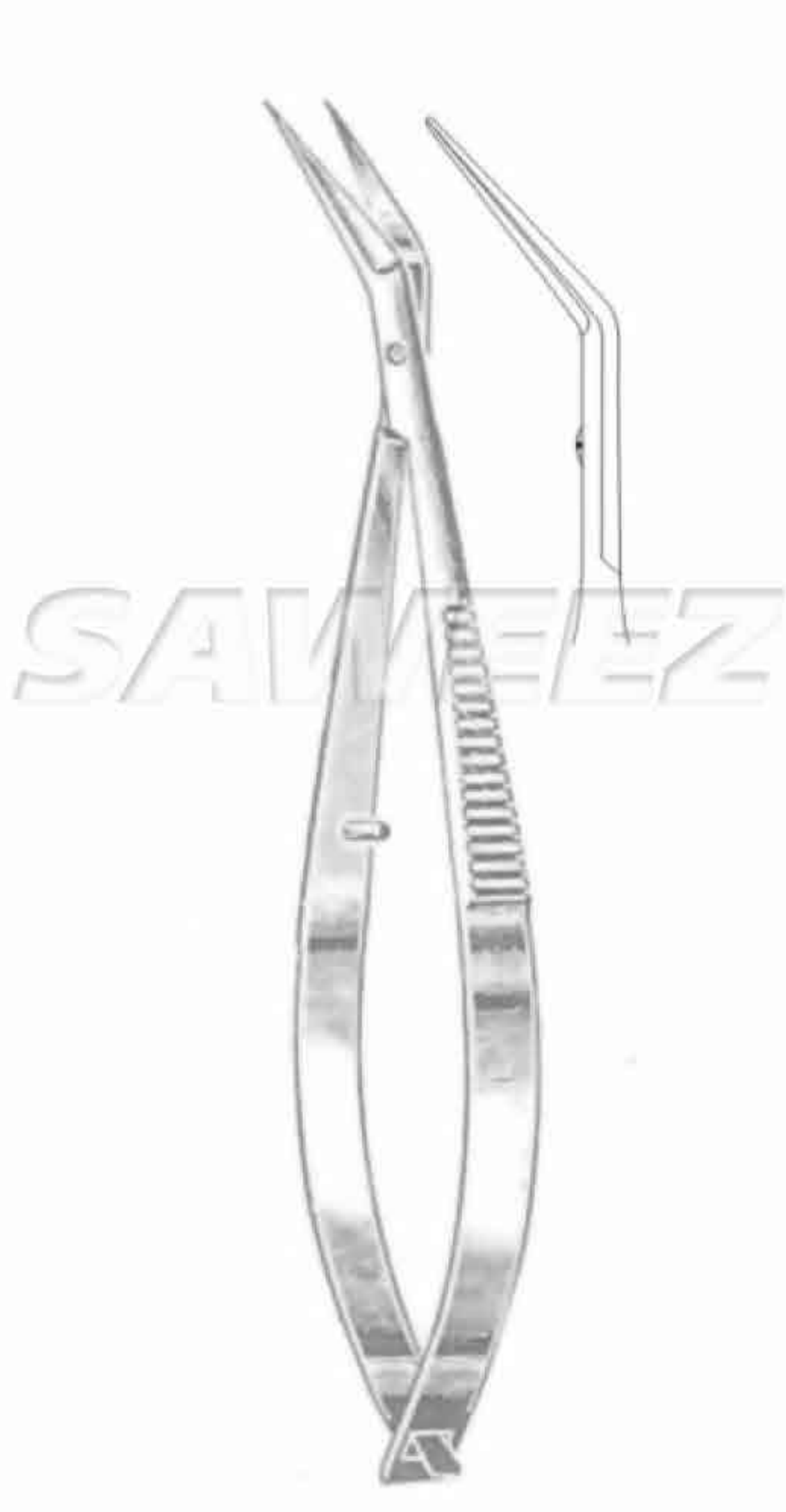
Micro Stitch Scissors
10.2cm / 4" 7mm blades,
fine sharp tips

SSC-55-13-09
SSC-55-13-10



Micro Stitch Scissors
11.4cm / 4½" 16mm blades,
sharp tips

SSC-55-13-11
SSC-55-13-12



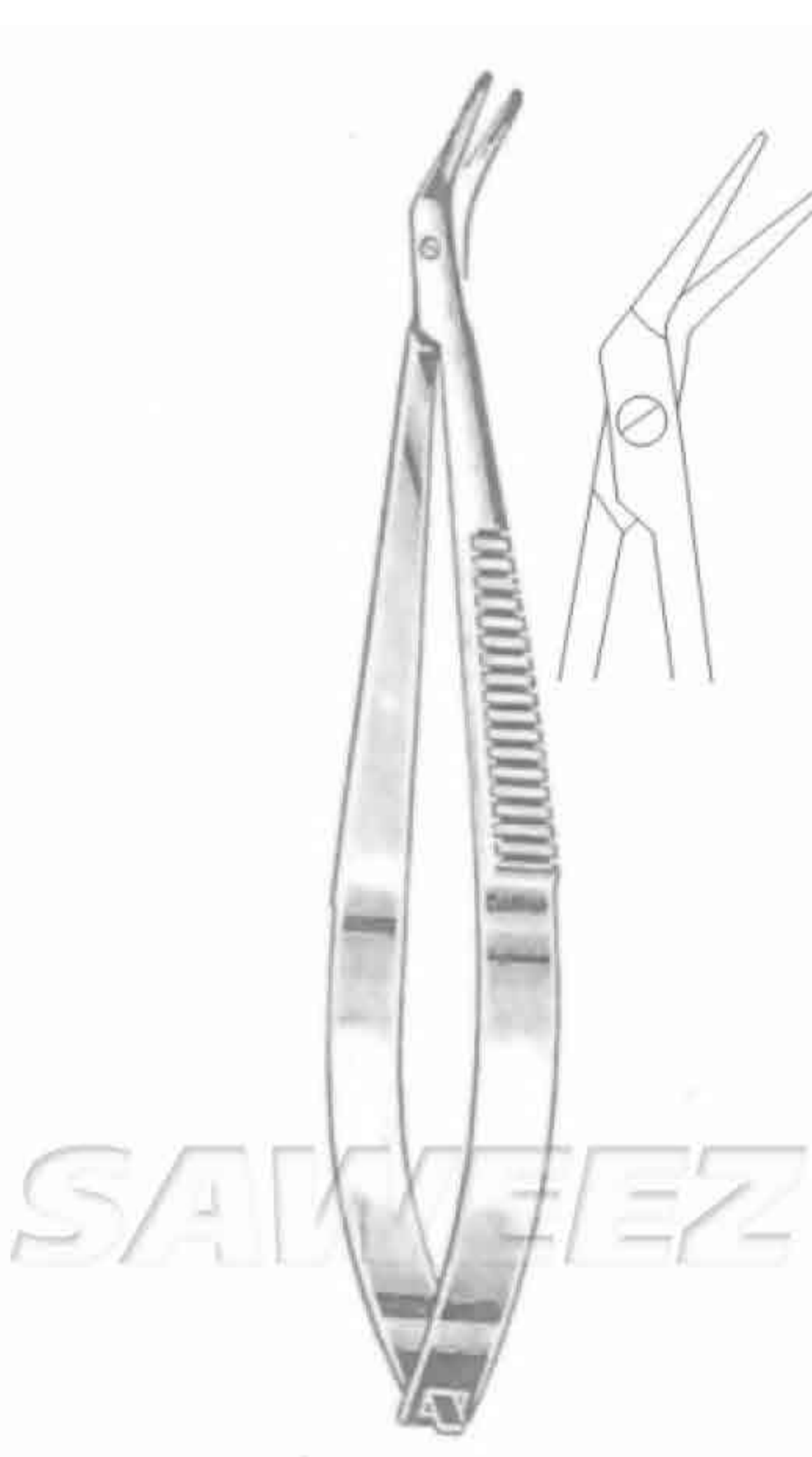
Mcclure Iris Scissors
11.4cm / 4½" 14mm blades,
angled on flat
SSC-55-13-13



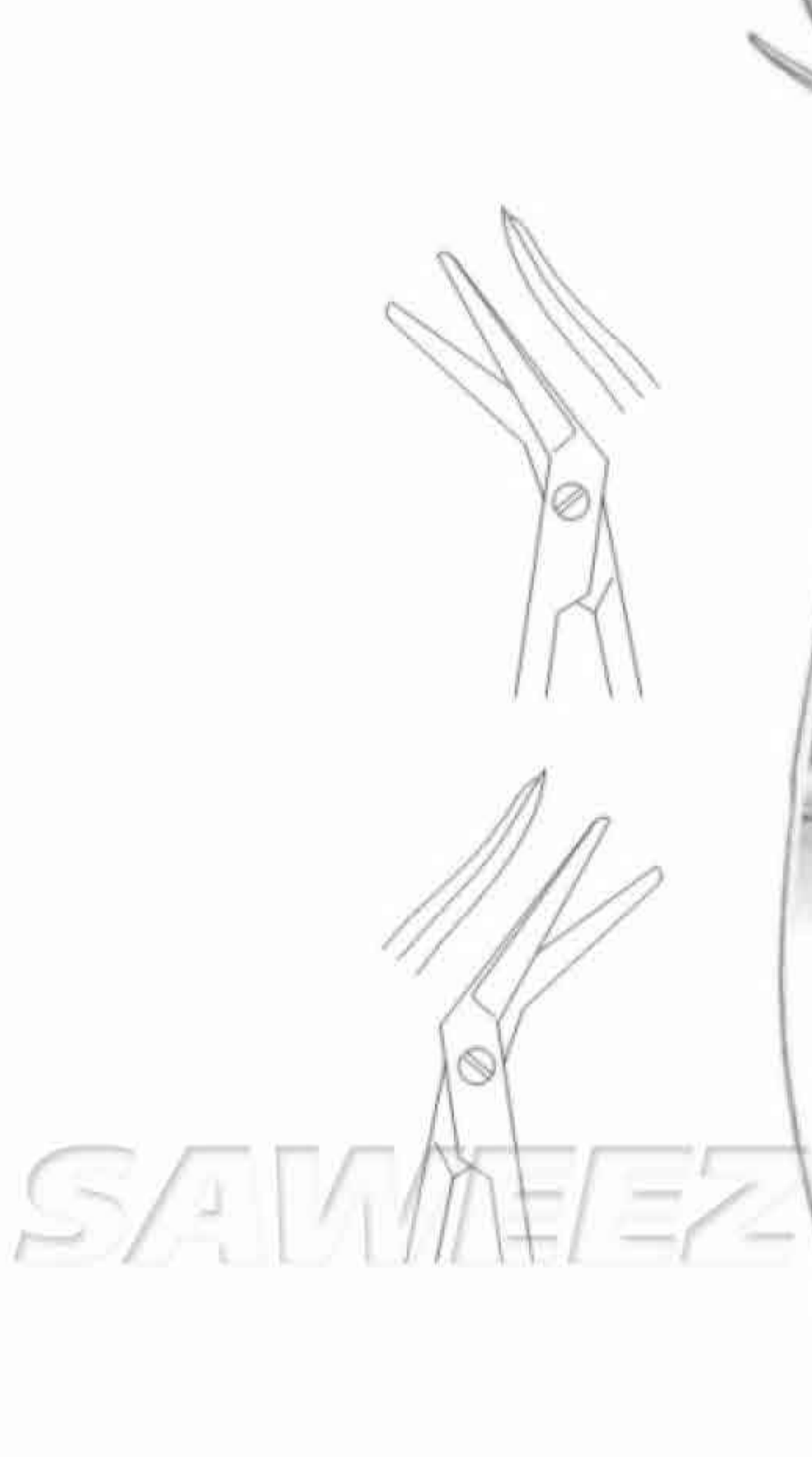
Castroviejo Corneal Scissors
10.8cm / 4¼" 12mm blades,
curved, blunt tips
SSC-55-13-14



Castroviejo Iris Scissors
9.5cm / 3¾" 11mm blades,
curved, sharp tips
SSC-55-13-15



Castroviejo Corneal Scissors
10.8cm / 4¼" 12mm blades,
angled, blunt tips
SSC-55-13-16



Castroviejo Corneal Section Scissors
10.8cm / 4¼" curved, blunt tips



SSC-55-13-17 Right, standard, 13mm blades
SSC-55-13-18 Left, standard, 13mm blades
SSC-55-13-19 Right, miniature 11mm blades
SSC-55-13-20 Left, miniature 11mm blades

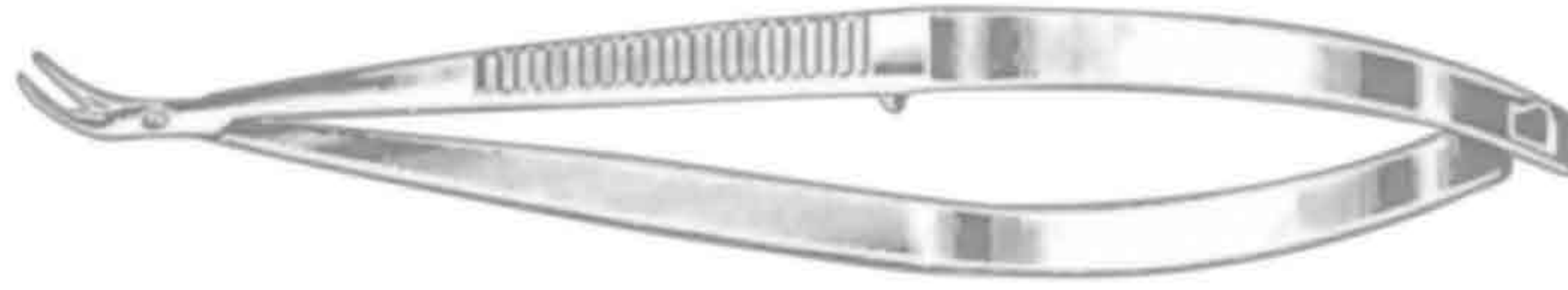
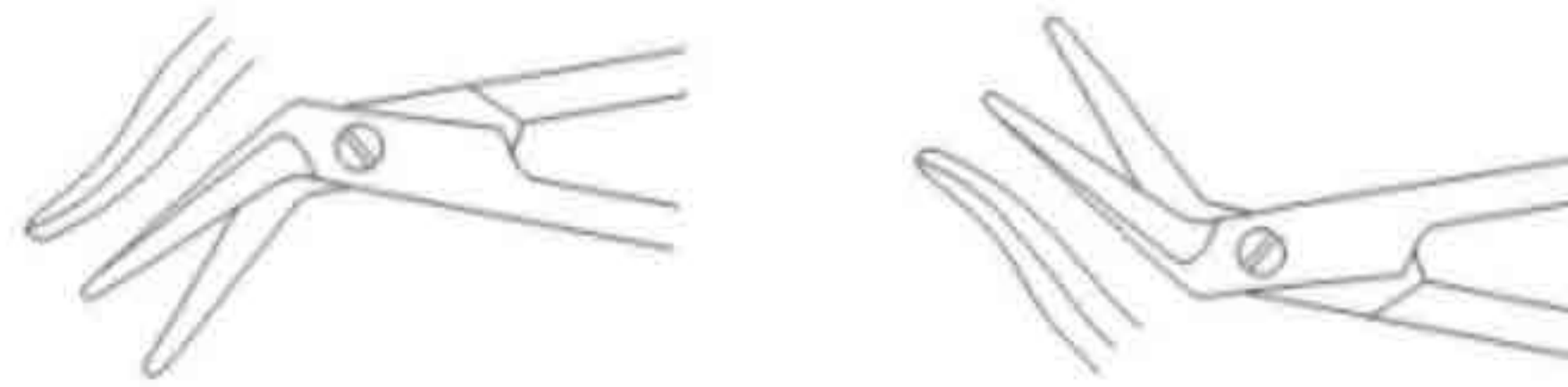


Castroviejo Corneal Section Scissors

10.2cm / 4" microsurgery 7mm blades, curved, blunt tips

SSC-55-13-21 Right

SSC-55-13-22 Left



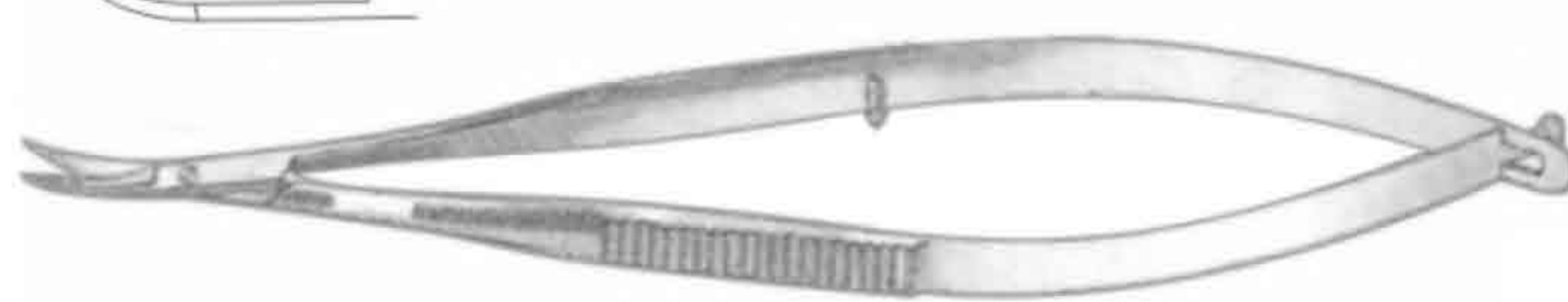
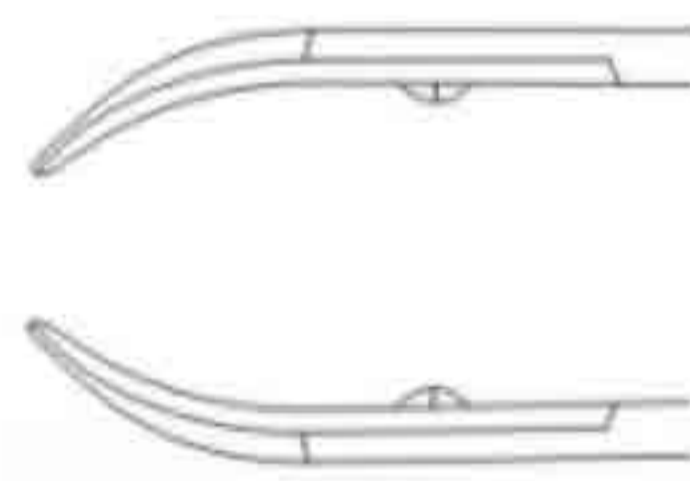
SAWEEZ SAWEEZ SAWEEZ SAWEEZ

Castroviejo Corneal Section Scissors

10.5cm / 4 1/8" miniature 7mm blades, curved, blunt tips

SSC-55-13-23 Left

SSC-55-13-24 Right



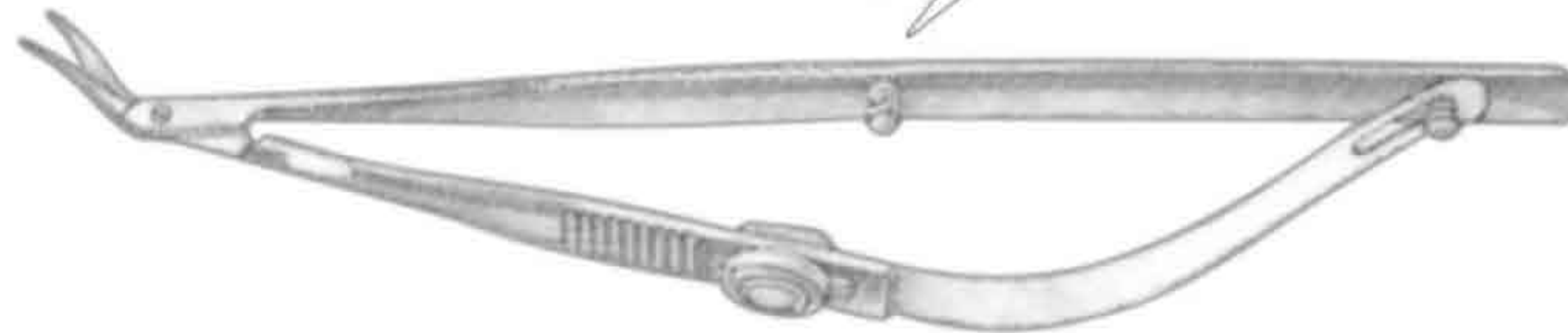
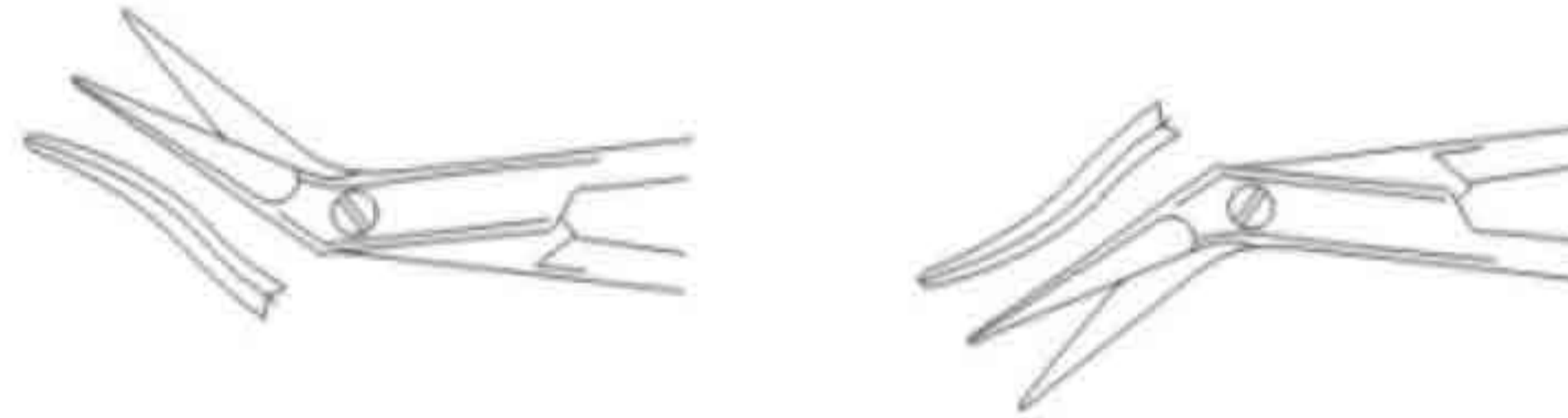
SAWEEZ SAWEEZ SAWEEZ SAWEEZ

Troutman-Castroviejo Corneal Section Scissors

10.5cm / 4 1/8" miniature 7mm blades, curved, blunt tips

SSC-55-13-25 Left

SSC-55-13-26 Right



SAWEEZ SAWEEZ SAWEEZ SAWEEZ

Vannas Capsulotomy Scissors

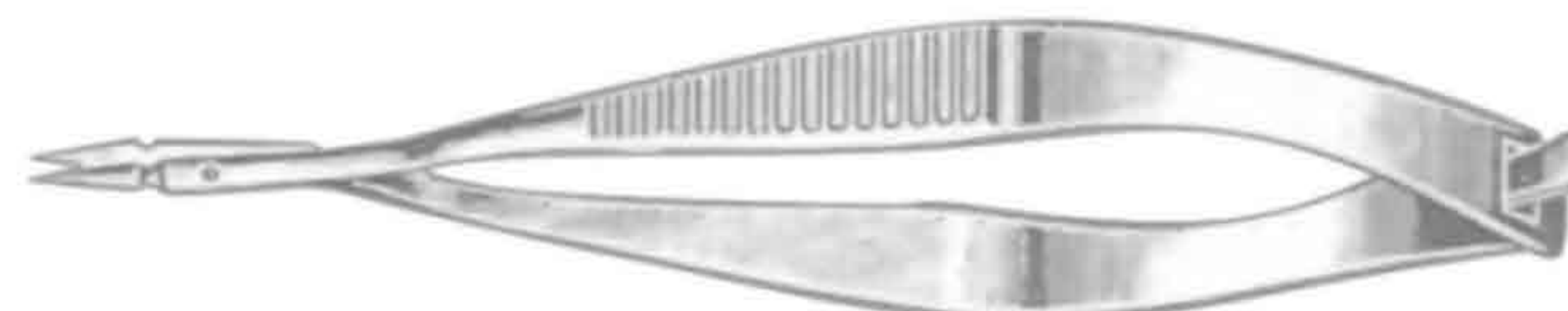
8.2cm / 3 1/4" sharp tips

SSC-55-13-27 Straight, 5mm blades

SSC-55-13-28 Curved, 5mm blades

SSC-55-13-29 Angled to side, 6mm blades

SSC-55-13-30 Angled on flat, 6mm blades



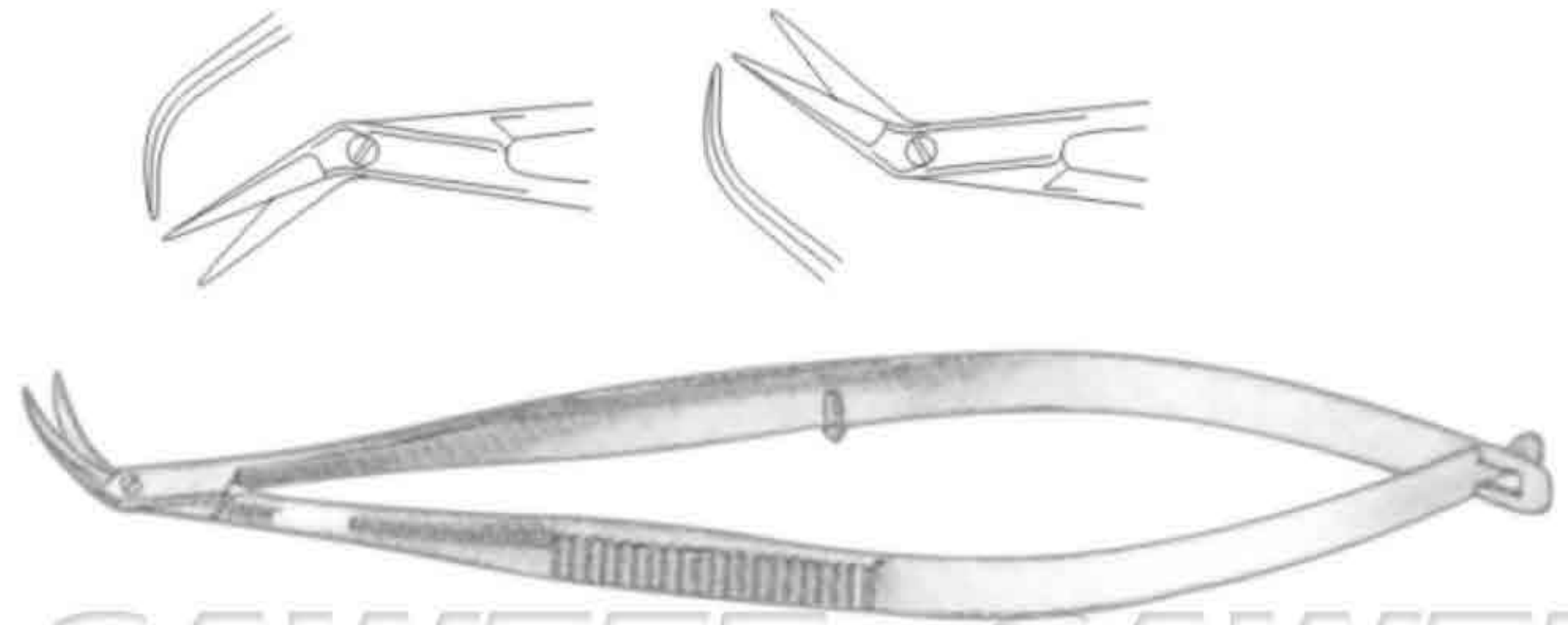


Katzin Corneal Transplant Scissors

10.8cm / 4¼", miniature 8mm blades, curved, blunt tips.

SSC-55-13-31 Left

SSC-55-13-32 Right

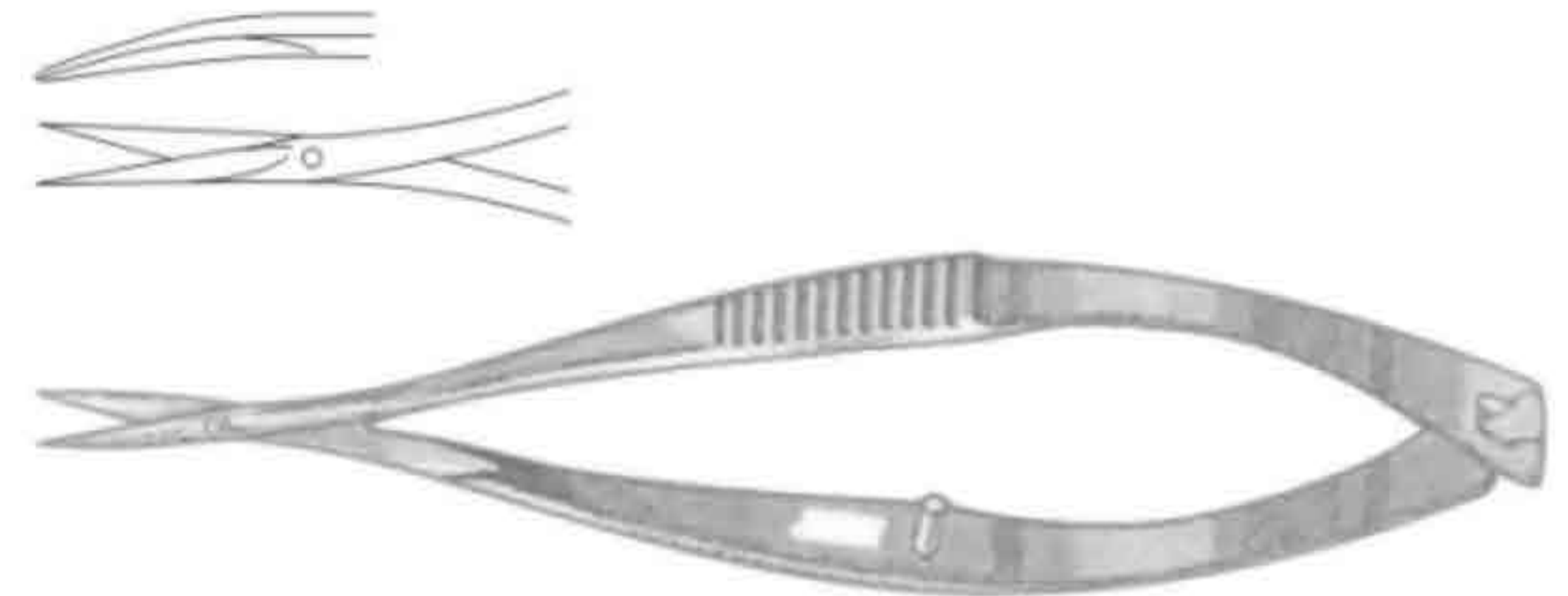


SAWEEZ SAWEEZ SAWEEZ SAWEEZ

Mcpherson-Vannas Iris Scissors

8.2cm / 3¼", 5mm blades, curved, sharp tips

SSC-55-13-33



SAWEEZ SAWEEZ SAWEEZ SAWEEZ

Gills-Welsh Vannas Scissors

angled, sharp tips

SSC-55-13-34 7.9cm / 3⁄8", microsurgery 5mm blades

SSC-55-13-35 8.6cm / 3⁄8", microsurgery 11mm blades



SAWEEZ SAWEEZ SAWEEZ SAWEEZ

Barraquer-Dewecker Iris Scissors

5.7cm / 2¼", 7mm blades, angled on flat, blunt tips

SSC-55-13-36

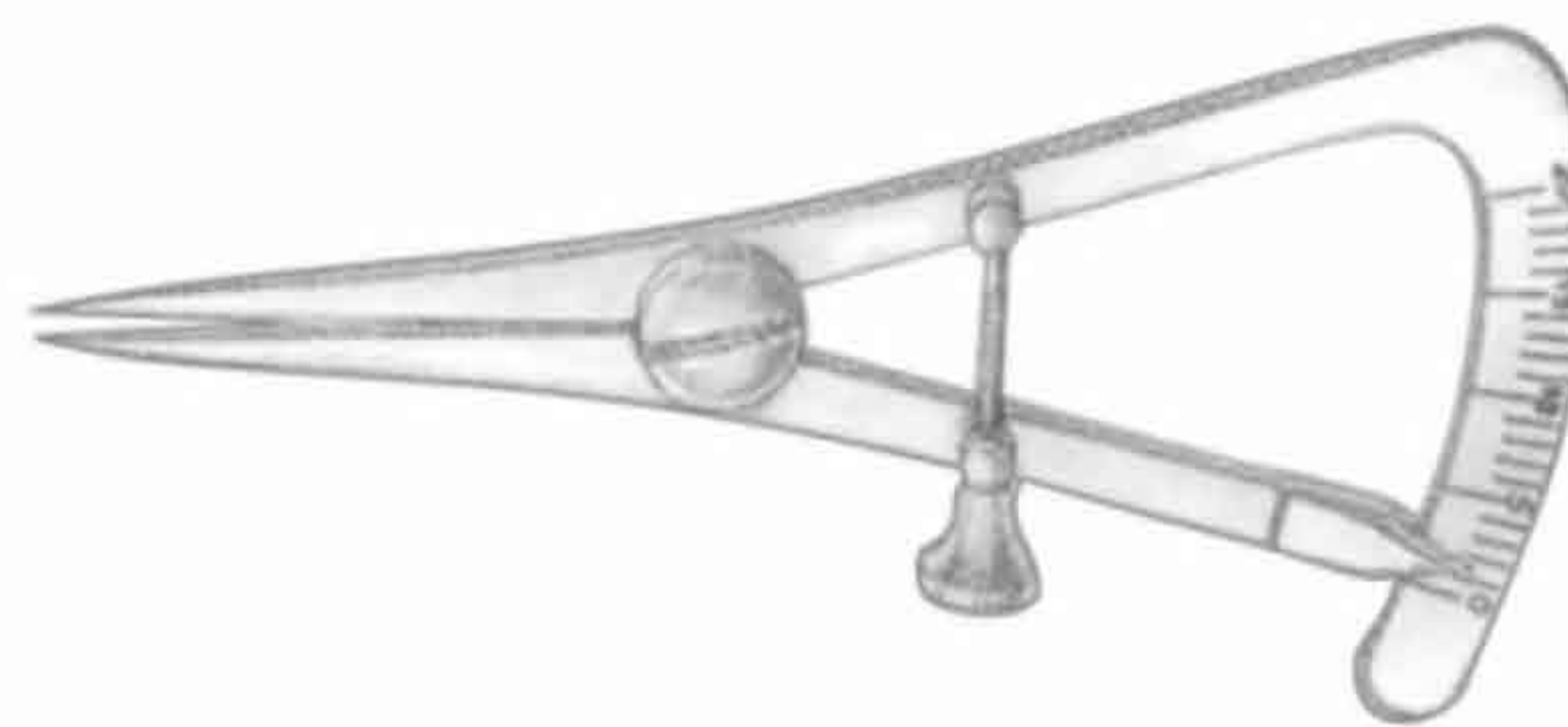




Castroviejo Caliper

8.2cm / 3¼", straight, measures from 0mm to 20mm in 1mm increments

SSC-55-13-37

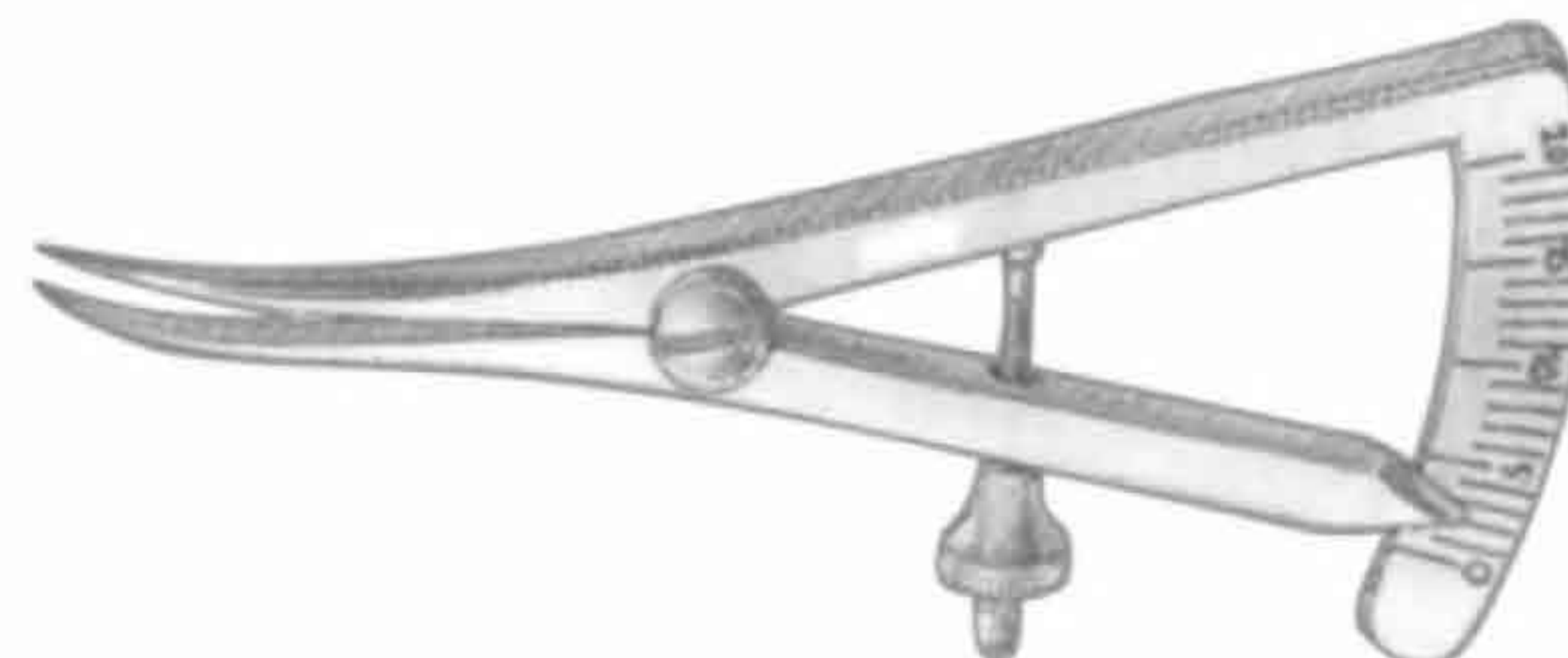


SAWEEZ SAWEEZ SAWEEZ SAWEEZ

Castroviejo Marking Caliper

8.6cm / 3⅜", curved, measures from 0mm to 20mm in 1mm increments with grooves for marking fluid

SSC-55-13-38

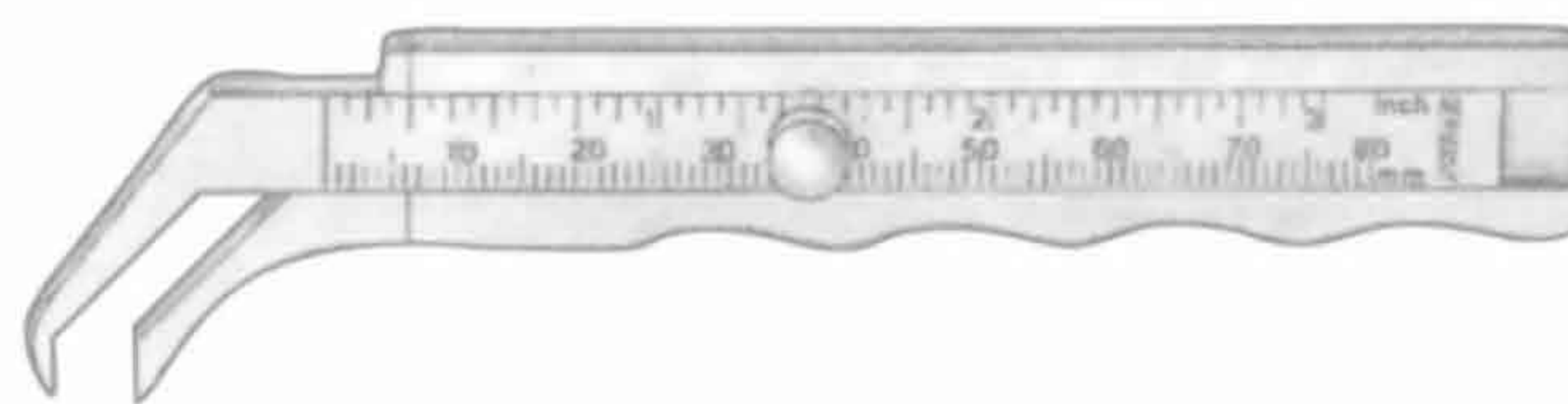


SAWEEZ SAWEEZ SAWEEZ SAWEEZ

Thorpe Caliper

12.1cm / 4¾", measures from 0mm to 80mm in 1mm increments with 0 to 3 inches in 1/16 increments

SSC-55-13-39



SAWEEZ SAWEEZ SAWEEZ SAWEEZ

Jameson Caliper

8.6cm / 3⅜", measures from 0mm to 80mm in 1mm increments and 0 to 3 inches in 1/16 increments

SSC-55-13-40





Steel Rule

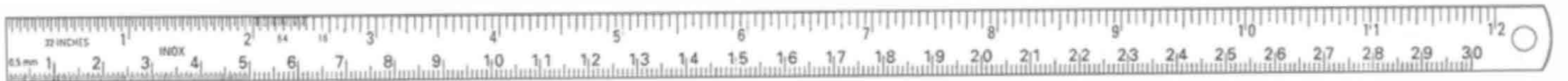
graduated, 15.0cm / 6"
SSC-55-13-41



SAWEEZ SAWEEZ SAWEEZ SAWEEZ

Steel Rule

graduated, 30.0cm / 12"
SSC-55-13-42

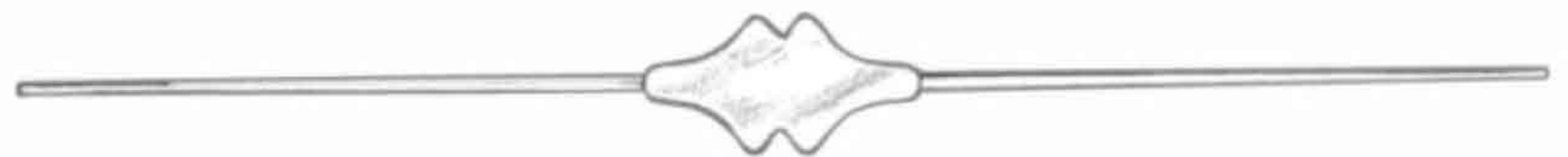


SAWEEZ SAWEEZ SAWEEZ SAWEEZ

Bowman Lacrimal Probes

12.4cm / 4 7/8", double-ended, silver

- SSC-55-13-43 Sizes 0000-000
- SSC-55-13-44 Sizes 00-0
- SSC-55-13-45 Sizes 1-2
- SSC-55-13-46 Sizes 3-4
- SSC-55-13-47 Sizes 5-6
- SSC-55-13-48 Sizes 7-8

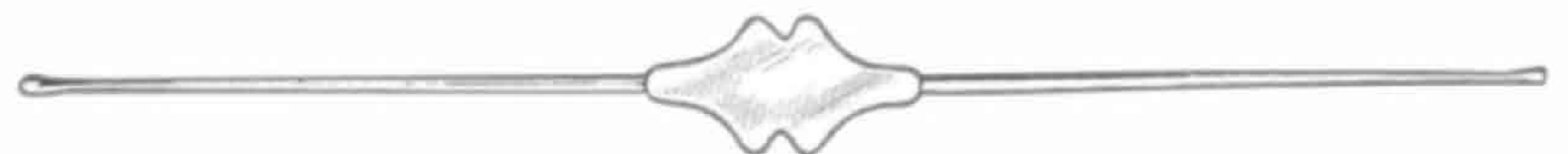


SAWEEZ SAWEEZ SAWEEZ SAWEEZ

Williams Lacrimal Probes

12.4cm / 4 7/8", double-ended, silver

- SSC-55-13-49 Sizes 0000-000
- SSC-55-13-50 Sizes 00-0
- SSC-55-13-51 Sizes 1-2
- SSC-55-13-52 Sizes 3-4
- SSC-55-13-53 Sizes 5-6
- SSC-55-13-54 Sizes 7-8



ALPHABETICAL INDEX



SAWEEZ®

A

Abdominal Retractors Baby-Collin	147
Abdominal Retractors Balfour	148, 149, 150
Abdominal Retractors Collin	147
Abdominal Retractors Gosset	148
Abdominal Retractors	147-150
Abdominal Spatulas Habre	151
Abdominal Spatulas Reverdin	151
Abdominal Spatulas	150
Abraham Tonsil Knives	450
Adenoid Curettes Beckmann	301
Adenoid Curettes	300-301
Adenotomes	302
AdlerKreutz Tissue forceps	41
Adson Brown	43, 101
Adson Artery forcep	055
Adson Dressing Forceps	37
Adson Dura Hooks	403
Adson Elevators	219
Adson Needle Holders	168
Adson Reamers	249
Adson Retractors	135, 139, 141
Adson Suction Tubes	158
Adson Tissue forceps	41
Alderdyce Elevators	220
Alexander Bone Chisels	195
Alexander Periosteal Raspatories	218
Allis Grasping Forceps	468
Allis Tissue and Organ Holding Forceps	339
Allis-Adair Tissue and Organ Holding Forceps	339
Allis-Atrauma Tissue and Organ Holding Forceps	338
Allis-Baby Tissue and Organ Holding Forceps	338
Alloy Tuning Forks	428
Allport Hooklets	436
Alm Retractors	132
Aly Sensibility Instruments	154
Amputating	248
Anderson-Adson	134
Andrew Toung Depressors	442
Angle Finger	266
Anis Needle Holders	503
Anoscope & Proctoscope	348
Antrum Punch Forceps	283
Antrum Retractor	302
Appel Spreader Dissecting Forceps	476
Arruga Capsule Forceps	501
Arruga Needle Holders	164, 176
Artery Clamps	62
Artery Foceps	50-58, 74-78
Artery Forcep Overholt-Geissendoerfer	61
Artery Forceps Negas	67
Artery Forceps and Scissors	76
Artery Forceps Baby- Mixer	59
Artery Forceps Baby-overholt	53
Artery Forceps Desjardins	67
Artery Forceps Leriche	52
Artery Forceps Pean	56
Artery Forceps Phaneuf	68
Artery Forceps Providence-Hospital	52
Artery Forceps Rankin-Crile	54
Artery Forceps	55
Artery Forceps	59
Artery Forceps Adson	55
Artery Forceps Crile	53
Artery Forceps Dandy	54
Artery Forceps Faure	70
Artery Forceps Finocchettio	64
Artery Forceps Gemini	61
Artery Forceps Guyon	65-66
Artery Forceps Heaney	68

Artery Forceps Kelly	52
Artery Forceps Koacher (Ochsner)	58
Artery Forceps Kocher	56
Artery Forceps Lahey	64
Artery Forceps Lovelace	54
Artery Forceps Lower	64
Artery Forceps Mcquiugg-Mixter	64
Artery Forceps Mixter	62
Artery Forceps Rankin-Kelly	53
Artery Forceps Rochester-Carmalt	55
Artery Forceps Rochester-Pean	57
Artery Forceps Werthiem	69-71
Artery Forceps Wickstrom	63
Artry Forceps Halsted-Mosquito	51
Artry Forceps Micro-Mosquito	51
Asch Rhinoplastic Instruments	298
Atrau-Allis Grasping Forceps	467
Atrau-Allis LJ Grasping Forceps	467
Atrauma Bulldog Clamps	311
Atrauma Cardiovascular Forceps Beck	331
Atrauma Cardiovascular Forceps Cooley	324, 335-336
Atrauma Cardiovascular Forceps Derra	331
Atrauma Cardiovascular Forceps Glover	331
Atrauma Cardiovascular Forceps Less	323
Atrauma Cardiovascular Forceps Potts	312
Atrauma Cardiovascular Forceps Satsinsky	321
Atrauma Cardiovascular Forceps Satsinsky	322
Atrauma Cardiovascular Forceps Weber	320
Atrauma Cardiovascular Forceps	309, 312-336
Atrauma Cardiovascular Forceps	313
Atrauma Intenstinal & Stomach Clamps Forceps	346
Atrauma Tissue Forceps De bakey	310, 313- 315, 317-319, 324- 330, 332
Atrauma Tissue Forceps	310
Atrauma Tissue Forceps Cooley	310
Aufricht Rhinoplastic Instruments	294, 297
Auto Retractor	265
Auvarad Vaginal Specula	368
Awls Obwegeser	448
Awls	448

B

Babcock Grasping Forceps	470, 471
Babcock Probe	5
Babcock Tissue and Organ Holding Forceps	340
Babcock-Atrauma Tissue and Organ Holding Forceps	340
Baby- Adson Ligature Forceps	59
Baby-Roux	128
Baby Detach Scissors	479
Baby- Mixer Artery Forceps	59
Baby Mixer Artry Forceps	50
Baby -Overholt Artery Forceps	53
Baby-Collin Abdominal Retractors	147
Backhaus Towel Forceps	72
BainBridge	315
Bakes Kidney Stone Probes	352
Balfour Abdominal Retractors	148, 149, 150
Ballaenger Septum knife	287
Ballenger Tonsil Seizing Forceps	452
Bandage Scissors Bergmann	185
Bandage Scissors Knowles	185
Bandage Scissors Lister	185
Bandage Scissors Tornado	185
Bandage Scissors	185, 187
Baraquer-Troutman Needle Holders	164
Barrett Forcep	374
Barbara	426



ALPHABETICAL INDEX

Barr Anal Retractors	359	Bone Holding Forceps Lane	233
Barraquer Cillia Forceps	499	Bone Holding Forceps Percy	234
Barraquer Iris Scissor	512	Bone Holding Forceps Verbugge	234
Barraquer Needle Holders	501, 503	Bone Holding Forceps	226-234
Barraquer Needle Holders	163	Bone Holding Forceps Ulrich	231
Barraquer Needle Holders	164, 176	Bone Hooks	213
Barth Curettes and Spoons	434	Bone Iris Forceps	491
Basic Orthopedic Set	259-268	Bone Iris Forceps	491
Beacham Tenaculum Forceps	376	Bone Levers Hohmann	221-223
Beck Atrauma Cardiovascular Forceps	331	Bone Levers	221-224
Beckmann Adenoid Curettes	300-301	Bone Pry	260
Beckmenn Retractors	141-142, 143	Bone Ronguer Forceps Blumenthal	237
Beerke Capsule Forceps	501	Bone Ronguer Forceps Cleveland	235
Bending Spanner	259	Bone Ronguer Forceps Friedmann	235
Bennett Spinal Retractors	224	Bone Ronguer Forceps Hartmann	236
Bergmann Bandage Scissors	185	Bone Ronguer Forceps Luer	237
Berliner Percussion Hammers	153	Bone Ronguer Forceps Mead	235, 236
Bessler/Treat' Suture Forceps	481	Bone Ronguer Forceps	235-241
Beyer Bone Ronguer Forceps	238	Bone Ronguer Forceps Lempert	236
Beyer Punches	432	Bone Ronguer Forceps Stellbrik	235
Billeau Loops,Foreign Body,Hooks	435	Bone Suture Forceps	491
Billrot Trocars	157	Bonney Dressing Forceps	100
Biopsy Forceps	480	Bose Laborde	362
Biopsy Forceps	480	Botvin Iris Forceps	489
Biopsy Hook Forceps	480	Bowman Lacrimal Probes	514
Biopsy Instruments	480	Bozeman Forcep	080
Biopsy Punches	480	Bozeman-Douglas	080
Bishop-Harmon Iros Forcep	489	Bozemann Needle Holder	181
Bircher Meniscotomy Knives	225	Bracken Fixation Forceps	490
Bladder Retractors Millin	357	Brain Leyla Retractor Double	418
Bladder Retractors	357	Brain Leyla Retractor Single	418
Blohmke Tonsil Seizing Forceps	452	Brain leyla Retractor	418
Blount Spinal Retractors	224	Brain Spatulas	399
Blumenthal Bone Ronguer Forceps	237	Braun Tenaculum Forceps	375, 380
Bodenhammer Rectal Speculum	359	Braun-Stadiur Episiotmy Scissors	30
Body Forceps Gross Maier	79	Breisky Obsterical forceps	391
Bohier Bone Ronguer Forceps	238	Brinkerhoff Rectal Specula	360
Boilate Tounge Depressors	443	Britton Angle Rongeur Scissors	263
Bonaccolto Utility Forceps	495	Britton Asseous Pin Bending Forceps	265
Bone And rib Shears Gluck	303	Britton Bedside Traction rack	264
Bone And rib Shears Stille	303	Britton Blouse Rack	264
Bone And rib Shears	303	Britton Bone Krishnor Scissors	265
Bone Chisels Alexander	195	Britton Rejection Forceps	264
Bone Chisels Buckley	194	Britton safely Screwdriver	261
Bone Chisels Mini-Lambotte	197	Britton Spine Retractor	266
Bone Chisels Partsch	195	Broken Nail Extractor	261
Bone Chisels Stille	196	Broken Nail Hollow Saw	260
Bone Chisels	194-200	Broncho-Esophagoscopy Forceps	455
Bone Curette	260	Bronchus Clamps	62
Bone Curettes and Hook	213	Brown Needle Holders	167
Bone Curettes Mod.USA	210	Brophy	043
Bone Curettes Schede	208	Bruenings Broncho-Esophagoscopy Forceps	455
Bone Curettes Simon	210	Bruenings Cutting and Grasping Forceps Tips	456
Bone Curettes Spratt	208	Bruenings Polypus	277
Bone Curettes Volkmann	207, 208, 211	Bruenings Tonsil Knives	450
Bone Curettes Williger	211	Bruenings Tonsil Snares	453
Bone Curettes	207-212	Bruenings Toug Depressors	443
Bone Curettes	214	Bruenings-Brunk	302
Bone Curettes Bruns	208, 209	Bruenings swivel knife	287
Bone Curettes Halle	210	Brunner Intestinal Clamp Forceps	341
Bone Curettes Martini	211	Brunner Retractors	122
Bone Curettes Williger	209	Brunner Sternum Scissors	304
Bone Drills	249	Bruns Bone Curettes	208, 209
Bone File Osteotribe	261	Bruns Oval Cup Curettes	212
Bone Flat Chisels	259	Bruns Plaster Shears	186
Bone Hammer	259	Bruns Plaster Shears	187
Bone Holding clamps	251	Buchwald Tounge Depressors	443
Bone Holding Clamps	262	Buck Curettes and Spoons	434
Bone Holding Forceps Dingamann	226	Buck Curettes	433

ALPHABETICAL INDEX



SAWEEZ®

Buck Percussion Hammers	152
Buckley Bone Chisels	194
Buckley Retractors	132
Buck-Gremcko Gouge	195
Buelau Trocars	156
Bulldog Clamps	48, 311
Bullet-Nose Dissecting Forceps	475
Burett Tenaculum Forceps	374
Busch Umbilical Scissors	31
Byrd Suction Tubes	162

C

Caliper	193
Callipers Casterveijo	513
Callipers Eye	513
Callipers Jameson	513
Callipers Thorpe	513
Campbell Trocars	156
Cannulated Pin Cutter	190
Caplan Septum Scissors	282
Capsule and Muscle Forceps	501
Capsule Fragment and Clot Forceps	501
Carbide inserts Metzenbaum	88-91
Cardiovascular	98-99
Carpenter Tonsil Knives	451
Carter Periosteal elevator	290
Castanares Face Lift Scissors	95
Casterveijo Callipers	513
Casterveijo Capsule Forceps	501
Casterveijo Corneal Section Scissors	510
Casterveijo Iris Scissor	510
Casterveijo Marking Callipers	513
Casterveijo Needle Holders	502
Casterveijo Suture Forceps	492
Casterveijo Utility Forceps	495
Castroviejo Needle Holders	165-166, 176
Catchers	353
Cather Dilating Bougles	358
Catheter Forceps	457
Cervical Biopsy Gelhorn	385
Cervical Biopsy	385, 387
Cervical Biopsy Faure	385
Cervical Vertebrae Trephine	266
Cervical Vertebra Retractor	268
Chalazian Forceps Francis	500
Chalazion Forceps Desmarres	500
Chalazion Forceps Health	500
Chalazion Forceps Hunt	500
Chalazion Forceps Lambert	500
Chalazion Forceps Lordon	500
Chalazion Forceps Snellen	500
Chalazion Forceps	500
Chandler Iris Forceps	496
Charrire	248
Cheron Forceps	080
Chelsea-Eaton Anal Speculum	360
Chevalier-Jackson Forceps	455
Chin, Chanselled	445
Cholangiogram Clamp	481
Cilia Forceps	47, 499
Cinelli Rhinoplastic Instruments	291
Citelli Punches	432
Clamps Forceps	71
Claw Grasping Forceps	469
Clayman Lens Flayer	499
Cleveland Bone Ronguer Forceps	235

Clothing Scissors	186
Clover Tonsil Seizing Forceps	452
Cloward Invertible Disc Rongeurs	405-407
Cloward Retractors	140
Cloward	404
Coakley Sharp Curettes	299
Cobb-Type Oval Cup Curettes	212
CogosWell Suction Tubes	162
Cohan Needle Holders	503
Cohen Cuticle Nippers	270
Colclough Invertible Disc Rongeurs	406-408
Collin Mouth Gags	441
Collin Obsterical forceps	391
Collin Tounge Depressors	443
Collin Uterine Elevating Forceps	383
Collin Vaginal Specula	363-364
Combined reamer	267
Compression Instrument	266
Conductor Steel Tyre	268
Cone Ring Curettes	214
Cone Ring Curettes	214
Converse Rhinoplastic Instruments	286, 295
Cooley Atrauma Cardiovascular Forceps	333-336
Cooley Atrauma Tissue Forceps	310
Cooley Rib Spreaders	305
Cooley Suction Tubes	161
Collier	167
Collin Forceps	049
Collin Mallets	202
Collin Retractor	147
Cordes Cutting and Grasping Forceps Tips	456
Cottle Dorsal Scissors	97
Cottle Nasal Knives	286
Cottle Nasal Scissors	29
Cottle Nasal Specula	274
Cottle Rhinoplastic Instruments	292, 294-295, 297
Cottle septum elevator	289, 290
Cottle-Kazanjian Bone Ronguer Forceps	242
Cottle-Walsham Rhinoplastic Instruments	298
Cotton applicators	7
Cotton applicators Fein	7
Cotton applicators Playfair	7
Cotton carrier for rectoscope Cotton applicators	7
Cotton Swab Forceps	80
Countersink Drill	260
Coupland Suction Tubes	162
Coxter Curettes and Spoons	434
Crafoard Thorax Scissors	25
Crile Artery Forceps	53
Crile-Murray Needle Holders	168
Crile-Wood Needle Holders	177
Craig polypus Forcep	277
Cross-Serations Artery forceps	50
Crura & Malleus Nippers	424
Curettes and Spoons	434
Curettes Randall Suction Biopsy	384
Curettes Suction Biopsy	384
Curettes	433
Curettes	437
Cusco Vaginal Specula	363-364
Cushing Brain Spatulas	399
Cushing Dressing Forceps	38
Cushing Dura Hooks	403
Cushing Hand Drills	250
Cushing Laminectomy Rongeurs	410
Cushing Nerve Hooks	401
Cushing Periosteal Raspatories	215
Cushing taylor	101
Cushing Retractors	101-109



ALPHABETICAL INDEX

Cuticle Nippers	270
Cuticle Nippers Cohen	270
Cuticle Scissors	270
Cutting and Grasping Forceps Tips Bruenings	456
Cutting and Grasping Forceps Tips Cordes	456
Cutting and Grasping Forceps Tips Fraenkel	456
Cutting and Grasping Forceps Tips Frankel	456
Cutting and Grasping Forceps Tips Krause	456
Cutting and Grasping Forceps Tips Lange	456
Cutting and Grasping Forceps Tips Rosenberg	456
Cutting and Grasping Forceps Tips Schumacher	456
Cutting and Grasping Forceps Tips Seiffert	456
Cutting and Grasping Forceps Tips	456
Czerny Tenaculum Forceps	380
Czerny Rectal Specula	347
Dale Cardiovascular Forceps	309

D

Dandy Artery Forceps	54
Dandy Elevators, Knives, Dura Hooks	402
Dandy Neurosurgical Scissors	28
Darling Retractors	145
Darting Uterine Elevating Forceps	383
Davis Dura Dissectors	397
Davis-Boyle Mouth Gags	440
Day Hooklets	436
De Bakey Atrauma Tissue Forceps	310, 313-315, 317-319, 324-330, 332
De Bakey Dressing Forceps	102
De Bekay	93, 178
Deaver Operating Scissors	14
De Bakey-Bahson Cardiovascular Forceps	326
De Bakey-Pean Cardiovascular Forcep	329
Deaver Retractors	124-126
Debakey Grasping Forceps	469
Dee Lee Obstetrical forceps	392
Dejerine Percussion Hammers	153
Denhart Mouth Gags	438
Depth Gauges	260
Derf Needle Holders	167, 177
Derra Atrauma Cardiovascular Forceps	331
Deschamps Reverdin Needle	174
Desjardins Artery Forceps	67
Desjardins Gall Stone Scoops	354
Desjardins Mayo-Blake Gall stone Forceps	353
Desk Typ Bending Forceps	264
Desmarres Chalazion Forceps	500
Desmarres Retractors	106
Detach Scissors System	478, 479
Diamant Tungstun Carbide	255
Diethrich Coronary Artery Scissors	99
Dietrich Vascular Scissor	26
Dieffenbach	048
Dietrich Needle Holder	175
Dilating Bougles	358
Dingamann Bone Holding Forceps	226
Dingman Mouth Gag	441
Disimpaction Forceps Rowe	449
Disimpaction Forceps	449
Dissecting Forceps	474-476
Dissecting Forceps	100-103
Dissecting Forceps	59
Dissecting Scissors	20
Dissecting Scissors	34
Dissecting Scissors Formon	23

Dissecting Scissors Metzenbaum	20
Dissecting Scissors Metzenbaum-Nelson	21-22
Dissectors Davis Dura	397
Dissectors Frazier Dura	397
Dittin Dilating Bougles	358
Double action Bone ronguers	263
Double Joint Outrigger Scissors	262
Double Use Guide Grill	259
Douglas Cillia Forceps	47, 499
Doyen Intestinal Clamp Forceps	341
Doyen Mallets	202
Doyen Myoma Instruments	382
Doyen operating scissors	19
Doyen Periosteal Raspatories	217
Doyen Probe	4
Doyen Retractors	121
Doyen Tounge Depressors	443
Doyen Uterine Polypus Forceps	381
Doyen Vaginal Specula	367
Doyen Vaginal Speculam	369
Doyen-Atrauma	346
Dressing and Cotton Swab	79
Dressing Forceps Adson	37
Dressing Forceps Cushing	38
Dressing Forceps De bakey	102
Dressing Forceps Ferris smith	100
Dressing Forceps Gerald	38
Dressing Forceps Gillies	100
Dressing Forceps Mc indoe	100
Dressing Forceps Mcindoe	37
Dressing forceps oehler	102
Dressing Forceps Semken	38
Dressing Forceps Taylor	38
Dressing Forceps	36-38
Dressing Forceps Eye	488
Dressing tampon	275
Dual-Cup Grabber Forceps	466
Duke Trocars	156
Duplay Tenaculum Forceps	375
Dura Dissectors	396, 397
Dura Hooks Adson	403
Dura Hooks Adson	403
Dura Hooks Cushing	403
Dura Hooks Fraizier	403
Dura Hooks Lahey	403
Dura Hooks Lahey	403
Dura Hooks	402
Dura Hooks	403
Duval Grasping Forceps	471
Duval Tissue and Organ Holding Forceps	43, 340

E

Ear Polypus Snares	429-431
Ear Specula Gruber	427
Ear Specula Hartmann	427
Ear Specula Toynbee	427
Ear Specula Zoliner	427
Ear Specula	427
Echlin Bone Ronguer Forceps	239
Elsching Fixation Forceps	490
Elevators Adson	219
Elevators Lempert	437
Elevators	402
Elevators	437
Elevators	219-220
Elliot Obstetrical forcep	392

ALPHABETICAL INDEX



SAWEEZ®

Enucleation Fine Operating Scissor	34	Fixation Forceps	490
Endarterectomy Scissors	98	Flat Nose Pliers	252
Endspecula	370	Flat Nose Pliers	192
Engel Saw	188	Fleurant Trocars	157
Ent Dignostic Set	464	Fluher Probe	5
Enucleation Scissor	509	Foerstar Sponge Forceps	472
Episiotomy Scissors Braun-Stadiur	30	Foerster Polypus Forceps	81-82
Episiotomy Scissors Waldmann	30	Fomon Dissecting Scissors	23
Episiotomy Scissors	30	Fomon Dorsal Scissors	97
Epstain Spinal Curettes	214	Fomon Lateral Scissors	97
Errico Hand Drills	250	Fomon Rhinoplastic Instruments	286, 291, 295-296
Esmarch Clothing Scissors	186, 188	Fomon Tonsil Scissors	29
Eves Tonsil Snares	453	Forceps Fine Tying	498
Excentric	185	Forceps Littauer Cillia	499
Extansion Bows	256-257	Forceps Sinskey Tying	498
Extansion Bows Kirschner	256	Forceps Cilia	499
Eye Callipers	513	Forceps Clips and Spplying	394
Eye Forceps Iris	488	Forceps Gradle Cillia	499
Eye Forceps	488-489	Forceps Yasargil	485
Eye Scissors	508-512	Forceps Douglas Cillia	499
Eye Dressing Forceps	488	Forceps Lens	499

F

Faure Cervical Biopsy	385	Forceps Barraquer Cillia	499
Fansler Operating Speculum	359	Forceps Fixation	490
Fansler Rectal Speculum	360	Forceps Microsurgical	482
Farabeuf Bone Holding Forceps	229	Forceps Schaaf Foreign Body	496
Farabeuf Periosteal Raspatories	216	Forceps Shepard Tying	498
Farabeuf Retractors	128	Foreign Body Forceps	79
Faulkner Sharp Curettes	299	Fraenkel Cutting and Grasping Forceps Tips	456
Faure Biopsy Forceps	385	Fraizier Dura Hooks	403
Faure Artery Forceps	70	Francis Chalazian Forceps	500
Fein Cotton applicators	7	Frankel Cutting and Grasping Forceps Tips	456
Feichenfeld	046	Frazier Dura Dissectors	397
Fergusson Bone Holding Forceps	227	Frazier Suction Tubes	158
Fergusson Vaginal Specula	363	Freeman Rhytidectomy Scissors	96
Fergusson	355	Freeman-Gorney Face Lift Scissors	96
Ferris-Smith Cup Jaw Rongeurs	417	Freeman-Kaye face Lift Scissors	96
Ferris-Smith Dressing Forceps	44, 100	Freer Rhinoplastic Instruments	291, 295
Ferris-Smith-Kerrison	409	Freer Septum elevators	288
Ferris-Smith-Kerrison	283, 284	Freer Septum knife	287
Fiber Optic Mccooy Laryngoscopes	463	Frenzel Tounge Depressors	443
Finocchietto Needle Holder	170, 180	Friedman Endspecula	370
Finocchietto Needle Holders	170	Friedmann Bone Ronguer Forceps	235
Fine operating Enucleation Scissors	33	Frosch Bone Holding Forceps	227
Fine operating Iris Scissors	34	Frykholm Bone Ronguer Forceps	240
Fine operating Scissor Strabismus	33	Fuller Crura & Malleus Nippers	424
Fine operating Scissors	24	Fundus Grasping Forceps	466
Fine operating Scissors	33, 34		
Fine operating Scissors	24		
Fine Tying Forceps	498		
Finger Ring Saws	247		
Finocchettio Artery Forceps	64		
Finocchietto Rib Spreaders	306-307		
Finocchietto-infant Baby	306		
Finocchietto-infant	306-307		
Finsen Retractors	131		
Fish Probe	3		
Fisher Tonsil Knives	450		
Fisher Tonsil Knives	450		
Fixation Forceps Bracken	490		
Fixation Forceps Elaching	490		
Fixation Forceps Green	490		
Fixation Forceps Lester	490		
Fixation Forceps Thorpe Conjunctional	490		
Fixation Forceps Von Graefe	490		

G

Galea Hooks	395
Gall Duct Clamps	62
Gallaher Rhinoplastic Instruments	294
Gall Duct Dilators	352
Gall stone Forceps	353
Gall Stone Scoops	354-355
Gelhorn Cervical Biopsy	385
Gelpe-Lactotite Retractors	146
Gemini Artery Forceps	61
General Instruments	94
Gennis Elevators, Knives, Dura Hooks	402
Gerald	100
Gerald Dressing Forceps	38
Germanic Laminectomy Rongeurs	263
Gerster Bone Holding clamps	251

ALPHABETICAL INDEX



SAWEEZ®

Gillies Needle Holder	171, 182	Heath Chalazion Forceps	500
Gill Iris Forceps	489	Hegar-Baumgartner	167, 177
Gillies Dressing Forceps	100	Heger-Vascular Needle Holder	181
Gillies Tissue Forceps	41	Heaney Needle Holder	178
Gills-Weish Vannas Scissors	512	Heaney Artery Forceps	68
Girard Corneo-Scieral Forceps	492	Heavy Duty Locking Pliers	193
Glertz-Stille Sternum Chisel	304	Heavy Duty Locking Pliers	192
Glover Atrauma Cardiovascular Forceps	331	Heifetz Tissue Forceps	045
Gluck Bone And rib Shears	303	Heifetz Brain Spatulas	399
Goelet Retractors	130	Heiss Artery Forceps	59
Goldsmith(thudichum)	272	Heister Mouth Gags	438
Gomel Suction Tubes	159	Helferich-Bier	248
Gorney Platysma Scissors	96	Hemi-Laminectomy Retractors	144
Gorney	95	Hemostats Putti	201
Gosset Abdominal Retractors	148	Hemostats	201
Gosset Bladder Retractors	357	Henke Tonsil Knives	451
Gouges	194-200	Henley Retractors	138
Graham Dura hooks	402	Henning Plaster Cast Instruments	189
Grabber Forceps	466	Henrotin Tenaculum Forceps	379
Gradle Cillia Forceps	499	Hepp/scheidel	159
Gradle Stich Scissor	509	Heyman Nasal Scissors	29
Graefe Retractors	104	Heymann Polypus Forceps	275
Graig Nasal Polypus	277	Heywood-Smith	350
Grasping and Extracting Forceps	468	Hibbs Bone Chisels	199-200
Grasping Forceps and Dissecting	468	Hibbs	199-200
Grasping Forceps	465-473	Hill-Ferguson Rectal retractors	361
Gruenwald	275	Hirschman Anoscopes	360
Graves Vaginal Specula	365	Hisschmann	348
Green Fixation Forceps	490	Hoehn Dura Dissectors	397
Green-Armytage Scalp Flap Forceps	393	Hoehn Elevators, Knives, Dura Hooks	402
Greven Wire Closure Forceps	423	Hoehn Periosteal Raspatories	215
Gross Loops, Foreign Body, Hooks	435	Hohmann Bone Levers	221-223
Gross-maier Forceps	79	Hoisher Nerve Root Retractors	400
Gruber Ear Specula	427	Hoke	199
Guyon Dilating Bougles	358	Hook Detach Scissors	478
Guthrie Retractors	104	Hook Scissors	477
Guy Tongue Forceps	441	Hooklets Day	436
Guyon Artery Forceps	65-66	Hooklets Lucae	436
Gynecological Scissors Mayo-noble	18	Hooklets Wagener	436
Gynecological Scissors	18	Hooklets	436
Gynecological Scissors Werthiem	18	Hooks Galea	395

H

Haas Tounge Depressors	443	Hopkin Plaster Shears	188
Habrer Abdominal Spatulas	151	Horsley Nerve Root Retractors	398
Hajek-Claus	285	House-Dieter Crura & Malleus Nippers	424
Hajek	283	Huber Broncho-Esophagoscopy Forceps	455
Hajek-kofler	283	Hudson Hand Drills	250
Halle Bone Curettes	210	Hunt Chalazion Forceps	500
Halle Elevators, Knives, Dura Hooks	288, 402	Hunter Bowel Forceps	472
Halsey Needle Holders	167, 177	Hunter Tissue	046
Halsted-Mosquito Artry forceps	50-51	Hurd Tonsil Knives	451
Hand Drills	250	Hysterectomy Forceps	71
Harken Atrauma Cardiovascular Forceps	322		
Harms Suture Tying Forceps	494, 495		
Harrington Retractors	123		
Hartmann Artery forceps	50		
Hartmann Bone Ronguer Forceps	236		
Hartmann Ear Polypus Snares	430		
Hartmann Ear Specula	427		
Hartmann Nasal Cutting forceps	280		
Hartmann Polypus Forceps	275		
Hartmann Polypus Forceps	276		
Hartmann Tounge Depressors	442		
Hartmann Tuning Forks	428		

I

Incision Scissors operating scissors	14
Indicator Rotating core	267
Inge Lamina Spreaders	404
Insenter Extractor	267
Instruments For Cranial Opening	337
Intestinal & Stomach Clamps (crushing Clamps)	345
Intestinal & Stomach Clamps Payr-baby	345
Intervertebral Disc Rongeurs	415-417
Intervertebral Disc Ronguer With exchangeable Tips	405
Intestinal Clamp Forceps Brunner	341
Intestinal Clamp Forceps Doyen	341
Intestinal Clamp Forceps Kocher	343

ALPHABETICAL INDEX

Intestinal Clamp Forceps Mayo-Robson	342
Intestinal Clamp Forceps Mikulicz	344
Intestinal Clamp Forceps Scudder	344
Intestinal Clamp Forceps	341-344
Invertible Disc Rongeurs	406-409
Iodine and Sterlizing Forceps	271
Iris Eye Forceps	488
Iris Forceps Botvin	489
Iris Forceps Chandler	496
Iris Forceps Gill	489
Iris Forceps Von Gaefe	489
Iris Scissor	504-506
Iris Scissors	34
Iris Scissors	94
Israel Retractors	115
Ives-Fansier	348

J

Jackson Ronguers	416
Jackson-Trachea Tube	362
Jacobs Tenaculum Forceps	379
Jacobson Forceps	487
Jacobson Scissors	486
Jansen Bone Rongeur	236
Jameson Callipers	513
Jameson Muscle Capsule Forceps	501
Jamison Needle Holders	169
Jamison Scissors	98
Jansen Curettes and Spoons	434
Jansen Ear Polypus Snares	429
Jansen-Struycken	281
Janson Retractors	133
Jennings Mouth Gags	439
Jet Wire Twister	268
Jewelers Forceps	493
Jewelers Style Forceps	493
Johns Hopkins	048
Johnson Needle Holders	170
Jones Towel Forceps	72
Joseph-Masing Periosteal Elevator	290
Joseph Dissecting Scissors	23
Joseph Nasal Knives	286
Joseph Rhinoplastic Instruments	293, 295-296
Joseph Septum Elevators	288, 290
Juers Wire Closure Forceps	423

K

Kalt Needle Holder	502
Kalt Needle Holders	163
Katzin Corneal Transplant Scissors	512
Kaye Face Lift Scissors	96
Kelly Artery Forceps	52
Kelly operating Scissors	19
Kelly Protoscopes diameter	360
kelly Anoscope	348
Kelly Retractors	120, 127
Kelly Uterine Polypus Forceps	381
Kelman-Mcpherson Suture tying Forceps	497
Kem Bone Holding Forceps	228
Kern Bone Holding Forceps	228
Kerrison Rongeurs	412
Kerrison Sphenois punches	285
Kevorkian Suction Biopsy Curettes	384

Kevorkian Biopsy Forceps	387
Key Elevators	220
Kidney Stone Forceps Randall	351
Kidney Stone Forceps	351
Kidney Stone Probes	352
Kielland Obsterical Forceps	392
Killian polypus Forceps	276
Killan Periosteal Elevators	289
Killian Nasal Specula	273
Killian Rhinoplastic Instruments	291
Killian Septum Scissors	282
Kilner operating Scissors	24
Kilner-Doughty Mouth Gags	439
Kirschner Extansion Bows	256
Klinkenbergh Vascular Scissor	25
Knapp Iris Scissor	504
Knight nasal Scissors	95
Knight Polypus Forceps	276
Knives	402
Knives	425
Knowles Bandage Scissors	185
Koacher (Ochsner) Artery Forceps	58
Kocher Artery Forceps	56
Kocher Intestinal Clamp Forceps	343
Kocher Retractors	112
Kocher Retractors	118-119, 121
Koerte Retractors	114
Kogan Endspectula	370
Krause Cutting and Grasping Forceps Tips	456
Krause Ear Polypus Snares	429
Kressner Rhinoplastic Instruments	298
Kristeller Retractors Vaginal Specula	365-366
Kroening Tounge Depressors	443
Kronecker Reverdin Needle	174

L

Laborde	362
La-Force (one Blade)	302
Lahey Artery Forceps	64
Lahey Dura Hooks	403
Lambert-Kay cardiovascular Forceps	324
Lambotte Bone Chisel	197
Lambert Chalazion Forceps	500
Lambotte Bone Holding Forceps	230
Lambotte Periosteal Raspatories	217
Lamina Spreaders Inge	404
Lamina Spreaders	404
Laminectomy Rongeurs	263, 410-414
Lampart Raspatory	437
Landolt Laminectomy Rongeurs	411
Lane Bone Holding Forceps	233
Langenbeck Needle Holder	184
Langenbeck Bone Holding	227
Lange Cutting and Grasping Forceps Tips	456
Lange Rhinoplastic Instruments	295
Langen back	248
Langenbeck Curettes	433
Langenbeck Elevators	219
Langenbeck Periosteal Raspatories	215
Langenbeck Periosteal Raspatories	216
Langenbeck Retractors	116-117, 119
Large Fragment Set	258
Large Pin Cutter	190
Lempert Elevator Raspatories & Curettes	437
Laryngeal mirrors	454

ALPHABETICAL INDEX



SAWEEZ®

Lebsche Sternum Chisel	304	Maryland Dissecting Forceps	475
Lebsche Sternum Scissors	304	Masing Periosteal Elevator	290
Lees Atrauma Cardiovascular Forceps	323	Masson Needle Holders	169, 179
Lekself-Stille Bone Ronguer Forceps	240	Mathieu Retractors	130
Leland-Jones	314	Matson Periosteal Raspatories	218
Lempert Bone Ronguer Forceps	236	Mathieu Needle Holders	172, 183
Lempert Elevators	437	Mayfield Bone Ronguer Forceps	238
Lens Forceps	499	Mayo-Ross	044
Lerche Tissue Forceps	41	Mayo Gall Stone Scoop	355
Lerliche Artery Forceps	52	Mayo Operating Scissors	477
Lester Fixation Forceps	490	Mayo operating Scissors	15
Lewin Bone Holding Forceps	226	Mayo scissors	94
Lewis Rhinoplastic Instruments	294	Mayo Toung Depressors	443
leyla Retractor Brain	418	Mayo Tungsten Carbide	85
Lichtenberg Needle Holders	172, 148	Mayo-Blake Gall stone Forceps	353
Ligature Forceps	59	Mayo-Harrington Operating scissors	15
Ligature Scissors Littauer	35	Mayo-Harrington Scissors	92
Ligature Scissors Spencer	35	Mayo-Hegar Needle Holders	168-169, 178
Ligature Scissors Universal	35	Mayo-noble Gynecological Scissors	18
Ligature Scissors	35	Mayo-Robson Intestinal Clamp Forceps	342
Lindemann	248	Mayo-Stillle operating Scissors	16-17
Lister Bandage Scissors	185	Mayo-Stillle Scissors	87
Lister Clothing Scissors	186, 187	Mc Lean Obsterical Forceps	392
Liston Bone Ronguer Forceps	242, 244-246	Mc Indoe Dressing Forceps	100
Littauer Cillia Forceps	47, 499	Mc Indoe Vascular Scissors	27
Littauer Ligature Scissors	35	Mccullough Utility Forceps	494
Littauer Polypus Forceps	276	Mcclure Iras Scissors	510
LockWood Tissue and Organ Holding Forceps	339	Mcindoe Dressing Forccepts	37
Lockwood-Allis Organ Holding Forceps	339	Mcintosh Fiber Optical	459-461
Loclin Operating and Gum Scissor	32	Mcintosh	458
Logan Retractors	131	Mcivor Mouth Gags	440
Loops,Foreign Body,Hooks	435	Mckenty	288-289
Lordon Chalazion Forceps	500	Mckenzie Clips and Splying Forceps	394
Lorna Towel Forceps	72	Mconald Elevators	220
Love Nerve Root Retractors	398	Mcperson Needle Holders	503
Love-Gruenwald Laminectomy Rongeurs	410, 413-414	Mcperson Suture tying Forceps	497
Lovelace Artery Forceps	54	Mcperson-Vannas Iris Scissors	512
Lovelace Tissue and Organ Holding Forceps	308	Mcquiugg-Mixer Artery Forceps	64
Lowa Tenaculum Forceps	377	Mead Bone Ronguer Forceps	235-236
Lower Artery Forceps	64	Mead Mallets	202
Lubet-Barbon	275	Meniscotomy Knives	225
Luc Polypus	277	Metzenbaum (lehey)	91, 94
Lucae Ear Polypus Snares	429	Metzenbaum Carbide inserts	88-91
Lucae Hooklets	436	Metzenbaum Detach Scissors	479
Lucae Mallets	202	Metzenbaum Dissecting Scissors	20
Luer Bone Ronguer Forceps	237	Metzenbaum Needle Holders	168
Luer Rectal Biospy Specimen Forceps	350	Metzenbaum Scissors	98
Luer-Koerte	354	Metzenbaum-Nelson Dissecting Scissors	21- 22
M			
Magill Catheter introducing Forceps	457	Meyerding Retractors	107
Mackenzie Drills	250	M.G.H	168
Maltz Rhinoplastic Instruments	294	Micro Biopsy Forceps	481
Mallets	202-206	Micro Detach Scissors	478, 479
Mallets Collin	202	Micro Dissecting Forceps	474
Mallets Doyen	202	Micro Ear Forceps	419-422
Mallets Lucae	202	Micro Elevaters Elevators	220
Mallets Mead	202	Micro Grassping Forceps	474
Mallets Partsch	202	Micro Stitch Scissors	510
Mallets Stainbatch	202	Micro Suture Ting Forceps	482
Mallets Winger	202	Micro-Adson	43, 101
Martel	337	Micro-Mosquito Artery Forceps	51
Marquardt Bone Rongeur	238	Micro-Needle Holders	163-166
Markwalder Bone Cutting Forceps	242	Microsurgical Forceps	482
Marking Callipers Casterveijo	513	Microsurgical Needle Holders	485
Martini Bone Curettes	211	Microsurgical Needle Holders	487
		Microsurgical Scissors	483
		Middleton-jansen	281
		Mikulicz Intestinal Clamp Forceps	344
		Miller Laryngoscopes	462
		Milligan Retractors	137

ALPHABETICAL INDEX



SAWEEZ®

Millin Bladder Retractors	357
Mini-Friedman Bone Rongeur	235
Mini Detach Scissors	479
Mini Mcgee Alligator	419
Mini Otoscope Fiber Optic (Pocket)	464
Mini-Gemini Artery Forceps	61
Mini-Hohmann Bone Levers	221
Mini-Lambotte Bone Chisels	197
Mini-Langenbeck Retractors	106
Mini-Roux Retractors	128
Mixer Artery Clamps	62
Mixer Dissecting Forceps	476
Mixer Gall Stone Scoop	353
Mixer Spender Dissecting Forceps	476
Mixer-o'Shaugnessy	62-63
Mod.Muenchen Suction Biopsy Curettes	384
Mod.Schweden Menisctomy Knives	225
Mod.USA Bone Curettes	210
Mod.USA Umbilical Scissors	31
Mod.Wien Nasal Specula	273
Mollison Retractors	136
Molt Mouth Gags	438
Moore	355
Morris-De Bakey Cardiovascular Forcep	325
Moritz-Schmidt Tounge Depressors	442
Mosquito- Dandy Artery Forceps	54
Mouth Gag Dingman	441
Mouth Gags Collin	441
Mouth Gags Davis-Boyle	440
Mouth Gags Denhart	438
Mouth Gags Guy	441
Mouth Gags Heister	438
Mouth Gags Jennings	439
Mouth Gags Kilner-Doughty	439
Mouth Gags Mcivor	440
Mouth Gags Molt	438
Mouth Gags Roser-Konig	438
Mouth Gags Seemann-Seiffert	439
Mouth Gags Whitehead	439
Mouth Gags Young	441
Mouth Gags	438-441
Moynihan Kidney Stone Probes	352
Mucous Knives	287
Muscle Retractors	267
Museux Tenaculum Forceps	378
Myles Nasal Cutting Forceps	280
Myoma Instruments	382

N

Nabatoff Probes Set	6
Naegle Obsterical forceps	391
Nail Instruments	247
Nail Nippers Turnbull	269
Nail Nippers	269
Nasal Cutting forceps	278-280
Nasal Knives Joseph	286
Nasal Knives	286
Nasal Polypus Forceps	275-276
Nasal Scissors	29
Nasal Specula	272-274
Needle Holders Collier	167
Needle Holders	484-487, 502-503
Needle Holders	167-172, 175-184
Needle Holders Adson	168
Needle Holders Arruga	164, 176
Needle Holders Baraquer-Troutman	164

Needle Holders Barraquer	163
Needle Holders Barraquer	164, 176
Needle Holders Brown	167
Needle Holders Castroviejo	165-166, 176
Needle Holders Crile-Murray	168, 171
Needle Holders Derf	167
Needle Holders Finccheitto	170
Needle Holders Halsey	167
Needle Holders Jamison	169
Needle Holders Jhonson	170
Needle Holders Kalt	163
Needle Holders Lichtenberg	172
Needle Holders Masson	169
Needle Holders Mathieu	172
Needle Holders Mayo-Hegar	168, 169
Needle Holders Metzenbaum	168
Needle Holders Neivert	167
Needle Holders Stratte	171
Needle Holders Webster	167
Needle Holders Yasargil	485
Needle Nose Dissecting Forceps	474
Needle Nose Pliers	191
Needles	426
Negus Artery Forceps	67
Neivert Needle Holders	167
Neivert Rhinoplastic Instruments	297
Neleton Probe	4
Nelson Trocars	156
Nelson Trocars	156
Nerve Detacher Orthopedic Set	261
Nerve Hooks Cushing	401
Nerve Hooks Scoville	401
Nerve Hooks Smithwick	401
Nerve Hooks	401
Nerve Root Retractors	398
Nerve Root Retractors	400
Nerve Root Retractors	267
Neumann Operating and Gum Scissors	32
Neuro-Duoflex Percussion Hammers	153
Neurosurgical Scissors	28
Neurosurgical Scissors Dandy	28
Neurosurgical Scissors Schmieden	28
Neurosurgical Scissors Strully	28
Neurosurgical Scissors Toennis-Adson	28
Newman Anoscope	348
Noto Uterine Polypus Forceps	381
Novak Suction Biopsy Curettes	384
Nubeor Suction Tubes	162
Nugent Utility Forceps	494

O

O'Brien Suture Scissors	509
O'Sullivan-O'Connor	369
O'Sullivan-O'Connor	150
O'Connor Retractors	104
Obsterical forceps Breisky	391
Obsterical forceps Collin	391
Obsterical forceps Dee Lee	392
Obsterical forceps Kielland	392
Obsterical forceps Mc Lean	392
Obsterical forceps Piper	392
Obsterical forceps Simpson-Braun	391
Obsterical forceps	391-392
Obsterical forcepsNaegle	391
Obwegeser Awls	448
Obwegeser Chin,Chanselled	445

ALPHABETICAL INDEX



SAWEEZ®

Obwegeser Periosteal Elevators	446-447	Periosteal Raspatories	215, 218
Obwegeser Soft Tissue Retractors	444-445, 447	Periosteal Raspatories Doyen	217
Ochsner Kidney Stone Probes	352	Periosteal Raspatories Williger	217
Ochsner Trocars	157	Perthes Reamers	249
Octoscope	464	Petit point Allis Tissue Forceps	77
Oehler Dressing Forceps	102	Petit point mixer Forceps	78
Oisen-Hegar	171, 182	Petit Point reynold Scissors	76
Oldberg Laminectomy Rongeurs	411	Petit-point Babock Forceps	78
Olivecrona	337	Petit-point Crile Forceps	75
OliverCrona Brain Spatulas	399	Petit-point Jacobson Mosquito Forceps	74
Olivercrona-Toennis (scoville)	394	Petit-Point Mosquito Forceps	74-75
Ollier Retractors	114	Petit-point pean forceps	75
Operating and Gum Scissor Locklin	32	Petit-point Pean ochsner Forceps	75
Operating and Gum Scissor Neumann	32	Petit-Point reconstructive Scissors	97
Operating and Gum Scissor Quinby	32	Petit-point reyder needle Holders	76-77
Operating and Gum Scissor	32	Petit-point Sarot Needle Holders	77
Operating scissors Deaver	14	Petit-pont olsen-hegar Needle Holders	76
Operating scissors Incision Scissors	14	Phaneuf Artery Forceps	68
Operating scissors Doyen	19	Pierce periosteal Elevator	289
Operating scissors Kelly	19	Pierse Suture Forceps	492
Operating scissors kilner	24	Pin Cutters	190
Operating Scissors Mayo-Stille	16-17	Pinard Strethoscope	154
Operating scissors Reynolds	24	Piper Obsterical forceps	392
Operating scissors Standard	8-13	Plaster Cast Instruments Wolff	189
Operating Scissors	8-17, 19, 24	Plaster Cast Instruments	189
Osteotome (straight)	259	Plaster of Paris Knives	188
Otoscope & Ent Diagnostic Set	464	Plaster Shears Bruns	186
Otoscope Fiber Optic (Pocket)	464	Plaster Shears Bruns	187
Overholt- Mixer Artery Forceps	59	Plaster Shears hopkins	188
Overholt-Geissendoerfer Artery Forceps	60	Plaster Shears Rianer	188
		Plaster Shears	186-187
		Plastic and Reconstructive Scissors	97
		Plastic Surgery Scissors	95
		Plate Bend Forceps	264
		Playfair Cotton Applicator	7
		Plester Knives	425
		Plester Retractors	137
		Pliers	191, 193
		Polack Utility Forceps	495
		Polypus Forceps	81-82
		Polypus & Dressing	80
		Polypus forceps Foerster	81-82
		Poole Suction Tubes	161
		Poppen Suction Tubes	158
		Ports de martel Thorax Scissors	27
		Potths-smith Thorax Scissor	27
		Potts Atrauma Cardiovascular Forceps	312-313
		Potts-Smith	99, 102
		Potts-Smith	38, 42
		Pozzl Tenaculum Forceps	374
		Prapp Sharp Curettes	299
		Pratt rectal Speculum	359
		Probe, Babcock	5
		Probe, Doyen	4
		Probe, Fish	3
		Probe, Fluher	5
		Probe, Neleton	4
		Probe, Stacke	4
		Probes Bowman Lacrimal	514
		Probes Set, Nabatoff	6
		Probes Williams Lacrimal	514
		Probes	3, 7
		Prostatic Retractors	356
		Providence-Hospital Artery Forceps	52
		Punches Beyer	432
		Punches Citelli	432
		Punches	432
		Putti Hemostats	201
		Pye-Smith (Harrison) Sterlizing Forceps	271

P

Paddle Babock Grasping Forceps	470
Paeker Langenbeck	130
Parallel Pliers	191
Parker Retractors	128-129
Partsch Bone Chisels	195
Partsch Mallets	202
Patella clamp	268
Payr-baby Intestinal & Stomach Clamps	345
Pean Artery forceps	56
Peapod (bead-Type)	416
Pederson Vaginal Specula	365
Pendfield Dura Dissectors	396
Pennington Forceps	049
Penner Nail Instruments	247
Pennington Periosteal Elevators	289-290
Percussion Hammers Rabiner	152
Percussion Hammers Berliner	153
Percussion Hammers Buck	152
Percussion Hammers Dejerine	153
Percussion Hammers Special-mobile	152
Percussion Hammers Taylor	153
Percussion Hammers Troemner	153
Percussion Hammers	152-153
Percy Bone Holding Forceps	234
Periosteal Elevator	259
Periosteal Elevators Obwegeser	446-447
Periosteal Elevators	446-447
Periosteal Elevators	267
Periosteal Elevators	289
Periosteal Raspatories Cushing	215
Periosteal Raspatories Farabeuf	216
Periosteal Raspatories Hoen	215
Periosteal Raspatories Langenbeck	215
Periosteal Raspatories Langenbeck	216



ALPHABETICAL INDEX

Q

Quin by Operating and Gum Scissor	32
Quire Ear Polypus Snares	430
Quire Polypus Forceps	276

R

Rabiner Percussion Hammers	152
Ractors Paeker Langenbeck	130
Radolf Nail Instruments	247
Ragnell-Devis Retractors	108
Rampley Swab forceps	82
Ramus Retractors	445
Randall Suction Biopsy Curettes	384
Randall Kidney Stone Forceps	351
Rankin Crile Artery Forceps	54
Rankin-Kelly Artery Forceps	53
Raspatories	437
Raspatory Lampart	437
Reamers	249
Recamier-Sims-Bumm	389
Reconstructive	95, 97
Rectal Biospy Specimen Forceps Luer	350
Rectal Biospy Specimen Forceps	349-350
Rectal Spacula	348
Rectal Specula	347
Reduction Forceps with points	262
Reetractors	361
Reiner Knife	188
Resecting saws	248
Retraction Grasping Forceps	467
Retractor Orthopedic Set	261
Retractors Brunner	122
Retractors Doyen	121
Retractors Gelpi-Lactotite	146
Retractors Israel	115
Retractors Kelly	120, 127
Retractors Kocher	112
Retractors Kocher	118-119, 121
Retractors Koerte	114
Retractors Langenbeck	116-117, 119
Retractors Meyerding	107
Retractors Milligan	137
Retractors Mollison	136
Retractors Ollier	114
Retractors Plester	137
Retractors Ragnell-Devis	108
Retractors Richard Eastmann	120
Retractors Sen-Green	108
Retractors Special Model	113
Retractors Strandell-Stille	110
Retractors Venehaken Brom	110
Retractors Volkmann	110-111
Retractors Wassmund	114
Retractors Adson	135, 139, 141
Retractors Alm	132
Retractors Beckmenn	141-143
Retractors Buckley	132
Retractors Cloward	140
Retractors Darling	145
Retractors Deaver	124-126
Retractors Desmarres	106
Retractors Farabeuf	128
Retractors Finsen	131
Retractors Graefe	104
Retractors Guthrie	104
Retractors Hemi-Laminectomy	144
Retractors Henley	138

Retractors Janson	133
Retractors Logan	131
Retractors Mathieu	130
Retractors Mini-Langenbeck	106
Retractors Mini-Roux	128
Retractors O'Connor	104
Retractors Parker	128-129
Retractors Retractors	130
Retractors Scalp Contour	133
Retractors Weitlaner	134, 136-137
Retractors	348
Retractors	104-146
Retractors Harrington	123
Retrograde Grasping Forceps	468
Reverdin Abdominal Spatulas	151
Reverdin Needle Deschamps	174
Reverdin Needle Kronecker	174
Reverdin Needle	173-174
Reverdin	173
Reynolds operating scissors	24
Rhinoplastic Instruments	291-298
Rhinoplastic	286
Rhoton Type Structure Tying Forceps	482
Rianer Plaster Shears	188
Rib Shears Sauerbruch	304
Rib Shears	304
Rib Spreaders Cooley	305
Rib Spreaders	305-307
Richard Eastmann Retractors	120
Rochester- Carmalt Artery Forceps	55
Rochester- Pean Artery Forceps	57
Roeder Towel Forceps	72
Roger Periosteal Elevators	289, 290
Rogge Sterlizing Forceps	271
Rosen Knives	425
Rosenberg Cutting and Grasping Forceps Tips	456
Roser-Konig Mouth Gags	438
Roux	127
Rowe Disimpaction Forceps	449
Rubin Septum Scissors	282
Rules and Probes	514
Ruskin Bone Ronguer Forceps	238
Ruskin-Liston Bone cutting Forceps	244
Russ Modell	43
Russian Grasping Forceps	472
Ryder Needle Holder	179, 180

S

Sachs Nerve Root Retractors	398
Saenger Scalp Flap Forceps	393
Safety Screw Driver	261
Samuel Vaginal Specula	368
Sarot Needle Holder	178
Satinsky vascular scissor	25
Satinsky Atrauma Cardiovascular Forceps	321
Satterie	248
Sauer Suture Forceps	496
Sauerbruch Sternum Chisel	304
Sauerbruch-Frey Rib Shears	304
Saurbruch Bone Ronguer Forceps	241
Saws	188
Sawyer Rectal Retractors	361
Schubertt Biopsy Forceps	385, 386
Scalp Contour	133
Scalp Flap Forceps Saenger	393
Scalp Flap Forceps	393

ALPHABETICAL INDEX



SAWEEZ®

Scalpel Handles	1-2	Sims Sound	374
Scalpel Handles, Standard	1-2	Similie Menisectomy Knives	225
Schaaf Foreign Body Forceps	496	Simon Bone Curettes	210
Schaedel Towel Forceps	72	Simon Uterine Scoops	388
Schede Bone Curettes	208	Simposon-Braun Obsterical forceps	391
Schiesnger Ronguers	415	Simpson-Luikart Obsterical forceps	391
Schmeden Nasal Cutting forceps	280	Sims Rectal Specula	347
Schmieden-Taylor Neurosurgical Scissors	28	Sims Rectal Speculum	359
Schmidt Tonsil Seizing Forceps	452	Sims Scissors	92
Schroeder Tenaculum Forceps	375, 377	Sims Tenaculum Forceps	374
Schroeder Uterine Scoops	388	Sims Vaginal Specula	366
Schuhmacher Umbilical Scissors	31	Sinskey Tying Forceps	498
Schuknecht Knives	425	Skene Tenaculum Forceps	376
Schuknecht Wire Closure Forceps	423	Skull Tractive Bow	265
Schumacher Cutting and Grasping Forceps Tips	456	Skull Tractive Row	266
Schumacher	387	Slip Joint Adjustable Pliers	191
Schwarz Nasal Specula	272	Small Fragment Set	258
Scissors Mayo-Harrington	92	Smith Anal Retractor	359
Scissors Mayo-Stille	87	Smith-Petersen	198
Scissors Sims	92	Smithwick Nerve Hooks	401
Scissors	477	Staude-Moore Forceps	374
Scissors	483, 485-486, 504-512	Stille Plaster Shears	187
Scissors	83-93	Stille-Liston Bone cutting Forceps	245
Scissors Jacobson	486	Straud-Moore Forceps	374
Scissors Yasaril	485	Swanstron Graping Forceps	471
Screw Driver	261	Snellen Chalazion Forceps	500
Screw Holding Forceps	267	Soft Tissue Retractors Obwegeser	444-445, 447
Scoops	353	Soft Tissue Retractors	444
Scovile Nerve Root Retractors	400	Somer Uterine Elevating Forceps	383
Scoville Disc Curettes	213	Spare Saw Blade	248
Scoville Nerve Hooks	401	Spare parts Vein Probes Set	6
Screw Tap	267	Special Mod. Britton	188
Scudder Intestinal Clamp Forceps	344	Special model	415
Sedillot Periosteal Raspatories	216	Special Model Bone Holding Forceps	226
Seemann-Seiffert Mouth Gags	439	Special Model Curettes and Spoons	434
Senn-Mueller	108	Special model Nail Instruments	247
Segond Myoma Instruments	382	Special Model Nasal Specula	273
Seiffert Cutting and Grasping Forceps Tips	456	Special Model Nerve Root Retractors	400
Sellheim Elevating Spoon	393	Special Model Obsterical forceps	391
Self Canterng Bone Holding	232, 262	Special Model Retractors	113
Selzing Forceps	252	Special Model Tenaculum Forceps	374
Semb Bone Holding Forceps	228	Special Model Tounge Depressors	443
Semb Bone Ronguer Forceps	239, 246	Specialization	481
Semb Periosteal Raspatories	218	Special-mobile Percussion Hammers	152
Semken Dressing Forceps	38	Specimen Forceps	385, 387
Semken	42, 100	Spectrum Compression forceps	281
Semm Vaginal Specula	365	Specula	359-360
Semmes (Howard)	212	Spencer Ligature Scissors	35
Sen-Green Retractors	108	Sphenois punches	283, 285-284
Sensibility Instruments	154	Spinal Fusion Curettes	212
Sensibility Instruments Aly	154	Spinal Gauage	259
Sensibility Instruments Weber	154	Spinal Gouges	259
Septum Compression Forceps	276	Spinal Plato Retractor	268
Septum elevators Freer	288	Spinal Retractors	224
Septum elevators Joseph	288	Sponge holders	7
Septum elevators	288	Spoon Forceps	481
Septum knife	287	Spratt Bone Curettes	208
Septum Scissors	282	Spreaders Lamina	404
Shank Bones and Splinter Bone	268	Spurling Laminectomy Rongeurs	410
Shapleigh Curettes	433	Spurling ronguers	263
Sharp Curettes Faulkner	299	St. Clair-Thomson	301
Sharp Curettes	299	Stacke Probe	4
Sharp Curettes Coakley	299	Stainbatch Mallets	20, 204
Sharp Curettes Prapp	299	Standard Dressing Forceps	36-38
Sheehan Rhinoplastic Instruments	293	Standard Narrow Dressing Forceps	36-37
Sheets-Mcpherson Tying Forceps	498	Standard Operating Scissors	8-13
Shepard Intraocular Lens Flare	499	Standard Scalpel Handles	1-2
Shepard Tying Forceps	498	Standard Scissors	83-85
Silver Rhinoplastic Instruments	293	Standard Trocars	155

ALPHABETICAL INDEX

Tounge Depressors Moritz-Schmidt	442
Tounge Depressors Special Model	443
Tounge Depressors Tobold	442
Tounge Depressors Wieder	442
Tounge Depressors	442-443
Towel Forceps	72
Towel Forceps Backhaus	72
Towel Forceps jones	72
Towel Forceps Lorna	72
Towel Forceps Roeder	72
Towel Forceps Schaedel	72
Townley Femur Calliper	193
Toynbee Ear Specula	427
Trachea Dilators	362
Trelat Vaginal Specula	364
Trocars Duke	156
Trocars	155-157
Trocars Billrot	157
Trocars Buelau	156
Trocars Campbell	156
Trocars Fleurant	157
Trocars Ochsner	157
Trocars Standard	155
Trocars Universal	155
Troeltsch (wilde) Ear Polypus Snares	429
Troemner Percussion Hammers	153
Troltsch Polypus Forceps	275
Trousseau Laborde	362
Troutman Needle Holders	503
Troutman Superior Rectus Forceps	501
Troutman-Barraquer Utility Forceps	495
Troutman-Casterveijo Corneal Suction Scissors	511
Troutmann-Barraquer Utility Forceps	491
Tubing Clumps Standard	73
Tubing Clumps	73
Tuffire Bone Holding Forceps	229
Tumer Forceps	81-82
Tungsten Carbide Inserts	83-93, 100-103, 175-184
Tungstun Carbide	252-255
Tuning Forks Hartmann	428
Tuning Forks	428
TurnBull Nail Nippers	269
Tyding Tonsil Snares	453
Tying Forceps Sheets-Mcpherson	498

U

Ulrich Bone Holding Forceps	231
Umbilical Scissors Busch	31
Umbilical Scissors Mod.USA	31
Umbilical Scissors Schumacher	31
Umbilical Scissors	31
Universal Bone Ronguer Forceps Universal	235
Universal Bone Ronguer Forceps	235
Universal Handle And Interchangeable Tubes	455
Universal Ligature Scissors	35
Universal Trocars	155
Uterine Curettes	389, 390
Uterine Dilators	371-373
Uterine Polypus Forceps	381
Uterine Scoops	388
Uterine Scoops Schroeder	388
Uterine Scoops Simon	388
Uterine Sounds	374
Uterine Elevating Forceps	383
Utility and Suture Forceps	494-498

Utility Forceps Bonaccolto	495
Utility Forceps Casterveijo	495
Utility Forceps Mccullough	494
Utility Forceps Nugent	494
Utility Forceps Polack	495
Utility Forceps Troutman-Barraquer	495
Utility Forceps Whills Hospital	494
Utility Scissor	506

V

Vaginal Forceps Wertheim	71
Vaginal Forceps	71
Vaginal Specula	363-369
Van Burn Dilating Bougles	358
Van Doren	386
Vannas Capsulotomy Scissors	511
Vascular Needle Holder	175
Vascular Scissor Dietrich	26
Vascular Scissors	25-27
Vasculolar scissor Klinkenbergh	25
Vein Probes Set Spare parts	6
Vein Probes Set	6
Venehaken Brom Retractors	110
Verbugge Bone Holding Forceps	234
volkman Bone Curettes	213
Volkman Bone Curettes	207-208, 211
Volkman Retractors	110-111
Voltolini Nasal Specula	272
Von Gaefe Iris Forceps	489
Von Graefe Fixation Forceps	490

W

Wagener Hooklets	436
Walter carmalt tissue forcep	046
Waldmann Episiotomy Scissors	30
Wangensteen	103, 170
Walton Nail Instruments	247
Wartenbarg	154
Wassmund Retractors	114
Watson-williams Nasal Cutting forceps	278
Watzke Sleeve Spreading Forceps	496
Weber Atrauma Cardiovascular Forceps	320
Weber Sensibility Instruments	154
WebSter Needle Holders	167, 177
Weil Nasal Cutting Forceps	279
Weitlaner Retractors	134, 136-137
Wertheim Gynecological Scissors	18
Wertheim Vaginal Forceps	71
Werthiem-cullen Artery Forceps	69-71
Westcott Utility Scissor	508
Westmacott Polypus Forceps	275
Whills Hospital Utility Forceps	494
White Tonsil Seizing Forceps	452
Whitehead Mouth Gags	439
Wickstrom Artery Forceps	63
Wieder Tounge Depressors	442
Wilde Ronguers	415
Williger Mallets	202
William Tissue and Organ Holding Forceps	339
Williams Lacrimal Probes	514
Williger Bone Curettes	209
Williger Bone Curettes	211
Williger Elevators	219



ALPHABETICAL INDEX

Tounge Depressors Moritz-Schmidt	442
Tounge Depressors Special Model	443
Tounge Depressors Tobold	442
Tounge Depressors Wieder	442
Tounge Depressors	442-443
Towel Forceps	72
Towel Forceps Backhaus	72
Towel Forceps Jones	72
Towel Forceps Lorna	72
Towel Forceps Roeder	72
Towel Forceps Schaedel	72
Townley Femur Calliper	193
Toynbee Ear Specula	427
Trachea Dilators	362
Trelat Vaginal Specula	364
Trocars Duke	156
Trocars	155-157
Trocars Billrot	157
Trocars Buelau	156
Trocars Campbell	156
Trocars Fleurant	157
Trocars Ochsner	157
Trocars Standard	155
Trocars Universal	155
Troeltsch (wilde) Ear Polypus Snares	429
Troemner Percussion Hammers	153
Troltsch Polypus Forceps	275
Trousseau Laborde	362
Troutman Needle Holders	503
Troutman Superior Rectus Forceps	501
Troutman-Barraquer Utility Forceps	495
Troutman-Casterveijo Corneal Suction Scissors	511
Troutmann-Barraquer Utility Forceps	491
Tubing Clumps Standard	73
Tubing Clumps	73
Tuffire Bone Holding Forceps	229
Tumer Forceps	81-82
Tungsten Carbide Inserts	83-93, 100-103, 175-184
Tungstun Carbide	252-255
Tuning Forks Hartmann	428
Tuning Forks	428
TurnBull Nail Nippers	269
Tyding Tonsil Snares	453
Tying Forceps Sheets-Mcpherson	498

U

Ulrich Bone Holding Forceps	231
Umbilical Scissors Busch	31
Umbilical Scissors Mod.USA	31
Umbilical Scissors Schumacher	31
Umbilical Scissors	31
Universal Bone Ronguer Forceps Universal	235
Universal Bone Ronguer Forceps	235
Universal Handle And Interchangeable Tubes	455
Universal Ligature Scissors	35
Universal Trocars	155
Uterine Curettes	389, 390
Uterine Dilators	371-373
Uterine Polypus Forceps	381
Uterine Scoops	388
Uterine Scoops Schroeder	388
Uterine Scoops Simon	388
Uterine Sounds	374
Uterine Elevating Forceps	383
Utility and Suture Forceps	494-498

Utility Forceps Bonaccolto	495
Utility Forceps Casterveijo	495
Utility Forceps Mccullough	494
Utility Forceps Nugent	494
Utility Forceps Polack	495
Utility Forceps Troutman-Barraquer	495
Utility Forceps Whills Hospital	494
Utility Scissor	506

V

Vaginal Forceps Wertheim	71
Vaginal Forceps	71
Vaginal Specula	363-369
Van Burn Dilating Bougles	358
Van Doren	386
Vannas Capsulotomy Scissors	511
Vascular Needle Holder	175
Vascular Scissor Dietrich	26
Vascular Scissors	25-27
Vascular scissor Klinkenbergh	25
Vein Probes Set Spare parts	6
Vein Probes Set	6
Venehaken Brom Retractors	110
Verbugge Bone Holding Forceps	234
volkman Bone Curettes	213
Volkman Bone Curettes	207-208, 211
Volkman Retractors	110-111
Voltolini Nasal Specula	272
Von Gaefe Iris Forceps	489
Von Graefe Fixation Forceps	490

W

Wagener Hooklets	436
Walter carmalt tissue forcep	046
Waldmann Episiotomy Scissors	30
Wangensteen	103, 170
Walton Nail Instruments	247
Wartenbarg	154
Wassmund Retractors	114
Watson-williams Nasal Cutting forceps	278
Watzke Sleeve Spreading Forceps	496
Weber Atrauma Cardiovascular Forceps	320
Weber Sensibility Instruments	154
Webster Needle Holders	167, 177
Weil Nasal Cutting Forceps	279
Weitlaner Retractors	134, 136-137
Wertheim Gynecological Scissors	18
Wertheim Vaginal Forceps	71
Werthiem-cullen Artery Forceps	69-71
Westcott Utility Scissor	508
Westmacott Polypus Forceps	275
Whills Hospital Utility Forceps	494
White Tonsil Seizing Forceps	452
Whitehead Mouth Gags	439
Wickstrom Artery Forceps	63
Wieder Tounge Depressors	442
Wilde Ronguers	415
Williger Mallets	202
William Tissue and Organ Holding Forceps	339
Williams Lacrimal Probes	514
Williger Bone Curettes	209
Williger Bone Curettes	211
Williger Elevators	219

**ALPHABETICAL
INDEX**

Williger Periosteal Raspatories	217
Willstein Micro ear Forceps	422
Wilmer Conjunctival Scissor	506
Wills Hospital utility Forceps	494
Williger Mallets	202
Winter Scalp Flap Forceps	393
Wire Closure Forceps	423
Wire Cutters	190
Wire Cutting Forceps	264-265
Wire Cutting Pliers	252, 254-255
Willstein Knives	425
Wullstien Micro Scissor	422
Wolff Plaster Cast Instruments	189
Wullstein Suction Tubes	158

Y

Yankauer Nasal Specula	274
Yankauer Suction Tubes	160
Yasargil Forceps	45, 485
Yasargil Galea Hooks	395
Yasargil Laminectomy Rongeurs	411
Yasargil Needle Holders	485
Yasargil Suction Tubes	159
Yasaril Scissors	485
Yeoman Rectal Biospy Specimen Forceps	349
Yankauer	297
Young Mouth Gags	441
Young Prostatic Retractors	356

Z

Zaufal Loops, Foreign Body, Hooks	435
Zaufal-jansen Bone Rongeur	238
Ziegler Cillia Forceps	499
Zweifel Needle Holder	184
Zoliner Ear Specula	427

Contacts



MANUFACTURERS AND EXPORTERS OF SURGICAL INSTRUMENTS



E-MAIL

info@saweez.com
www.saweez.com



TEL

+92 (052) 45 92 136



ADD

Talwara Mughalan,
Sialkot-51310-Pakistan